

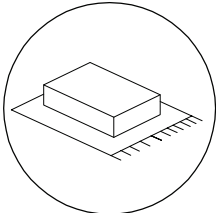

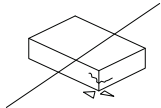



		20'
 		
		1

1/5

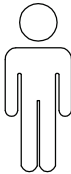
A	B	C	D	E
				
x 1	x 1	x 2	x 2	x 2

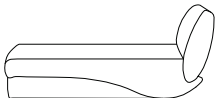
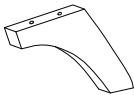

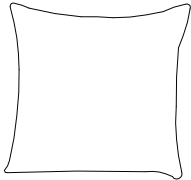
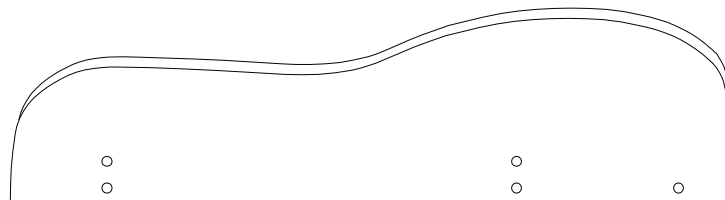
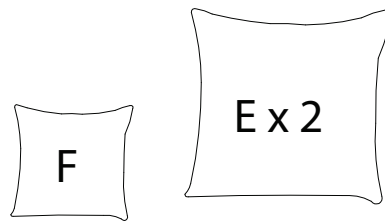
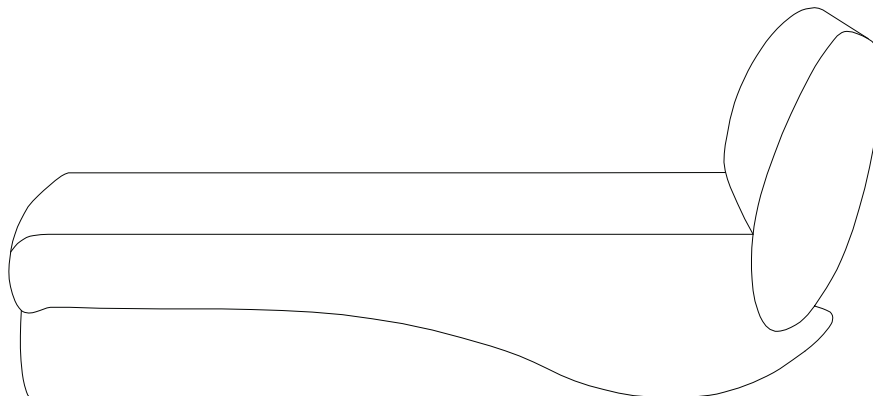
A



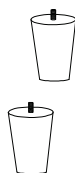

B

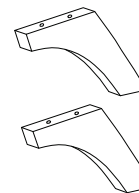

C x 2



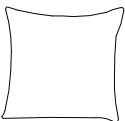
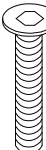
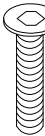
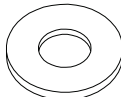

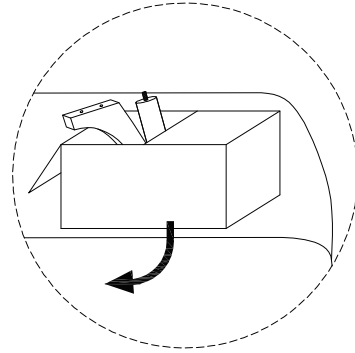
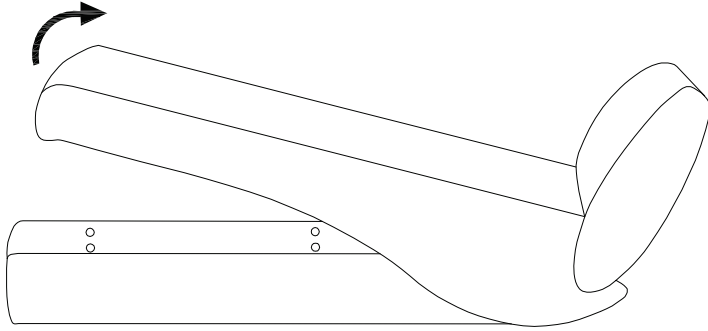

D x 2

F	G	H	I	J
	 M8 x 80	 M8 x 60		
x 1	x 2	x 7	x 9	x 1

!

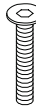
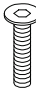

1

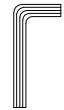
B  x1	C  x2	D  x2	G  M8 x 80 x2	H  M8 x 60 x2	I  x4	J  x1
---	---	---	--	---	---	---

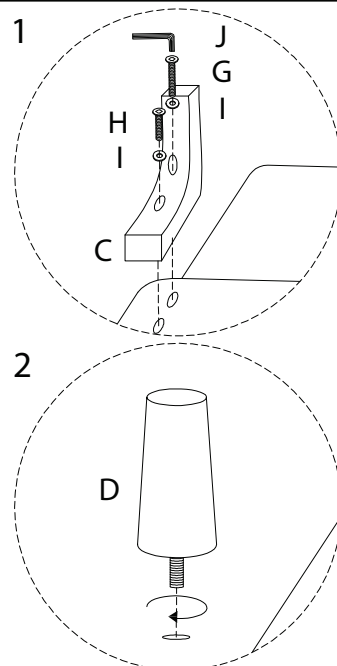
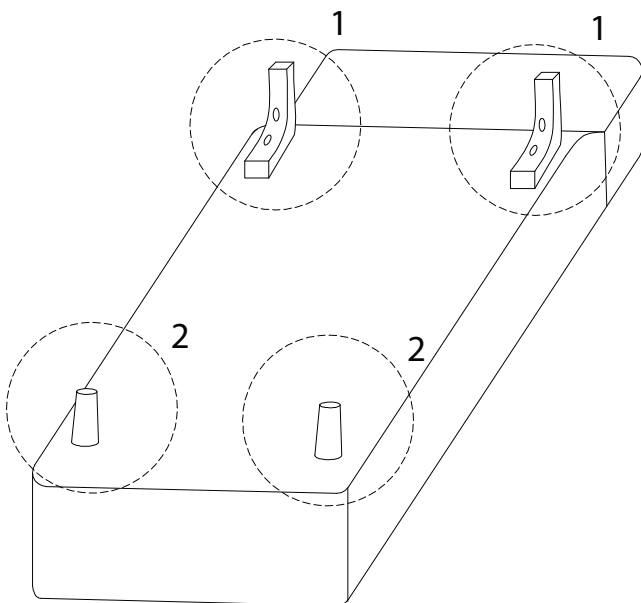

2

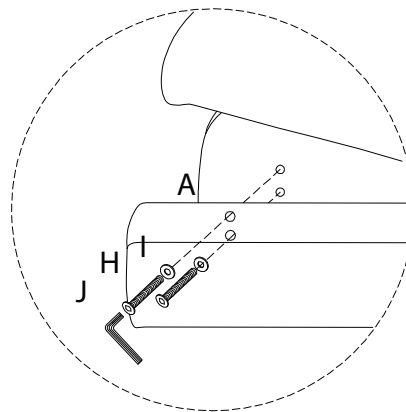
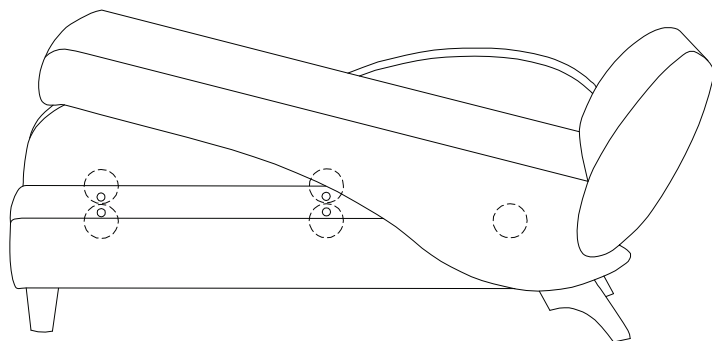
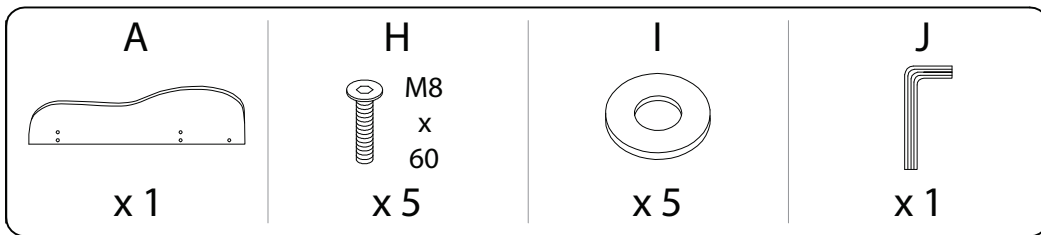

3

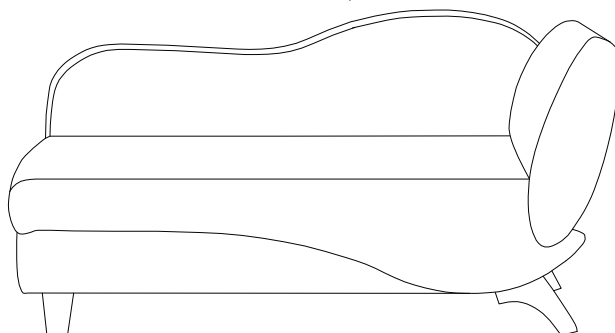
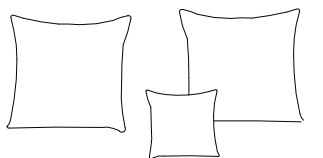
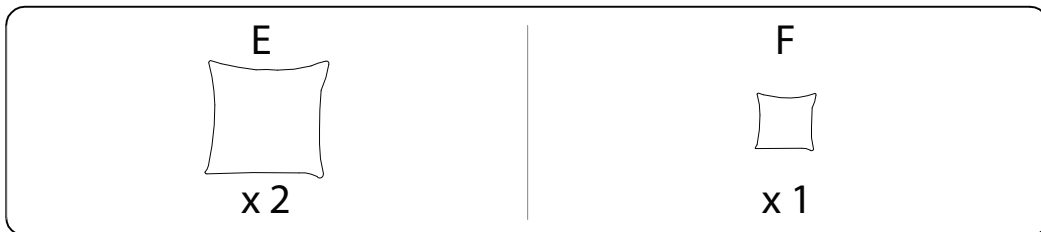

4

