

ASSEMBLY INSTRUCTION OF CHAIR







80330FG

! Let op: Bij het monteren van het meubel eerst alle schroeven half indraaien.
Pas als alle schroeven op de plek zitten alles vast draaien.

Note: When assembling the furniture, first screw all screws halfway.
When all the screws are in place, tighten everything.

Achtung! Um die Montage des Möbelstückes zu vereinfachen,
erst alle Schrauben handfest andrehen und am Ende erst alle Schrauben
fest anziehen.

Attention: Avec votre meuble, tous les visser par rapidement monter.
Ci tout sur son place, vous pouvez les monter.

No.	PARTS LIST	DESCRIPTION	QTY
A		SEAT	1
B		LEG-1	2
C		LEG-2	2
AA		BOLT CAP(M6)	12
BB		BOLT(M6*15)	12
CC		WASHER	12
DD		ALLEN KEY	1

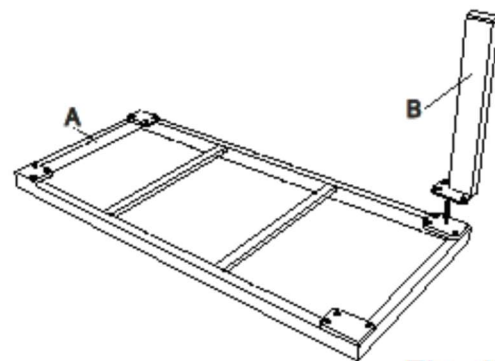

Fig. 1

ASSEMBLY INSTRUCTION OF SOFA 80330FG



Let op: Bij het monteren van het meubel eerst alle schroeven half indraaien.
Pas als alle schroeven op de plek zitten alles vast draaien.

Note: When assembling the furniture, first screw all screws halfway.
When all the screws are in place, tighten everything.

Achtung! Um die Montage des Möbelstückes zu vereinfachen,
erst alle Schrauben handfest andrehen und am Ende erst alle Schrauben
fest anziehen.

Attention: Avec votre meuble, tous les visser par rapidement monter.
Ci tout sur son place, vous pouvez les monter.



















No.	PARTS LIST	DESCRIPTION	QTY
A		LEG-L	1
B		LEG-R	1
C		BACK-L	1
D		BACK-R	1
E		SEAT	2
F		SEAT&BACK	1
G		SEAT CUSHION-1	2
H		BACK CUSHION-1	4
I		SEAT CUSHION-2	1
J		BACK CUSHION-2	1
K		BACK CUSHION-3	1
AA		BOLT CAP(M6)	22
BB		BOLT(M6*35)	14
CC		BOLT(M6*50)	8
DD		WASHER	30
EE		NUT(M6)	8
FF		NUT CAP(M6)	8
GG		ALLEN KEY	1



Fig. 1

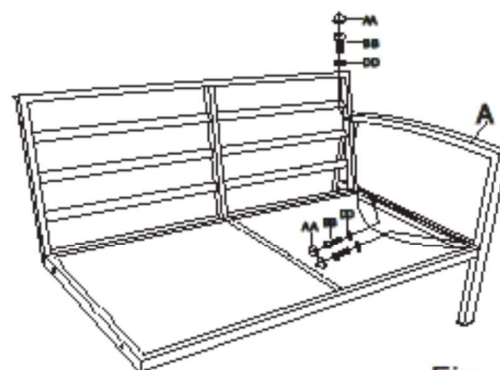

Fig. 2

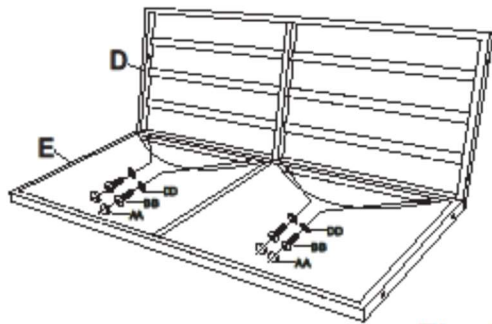

Fig. 3

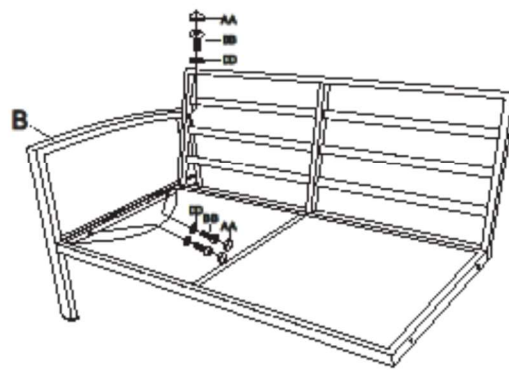

Fig. 4

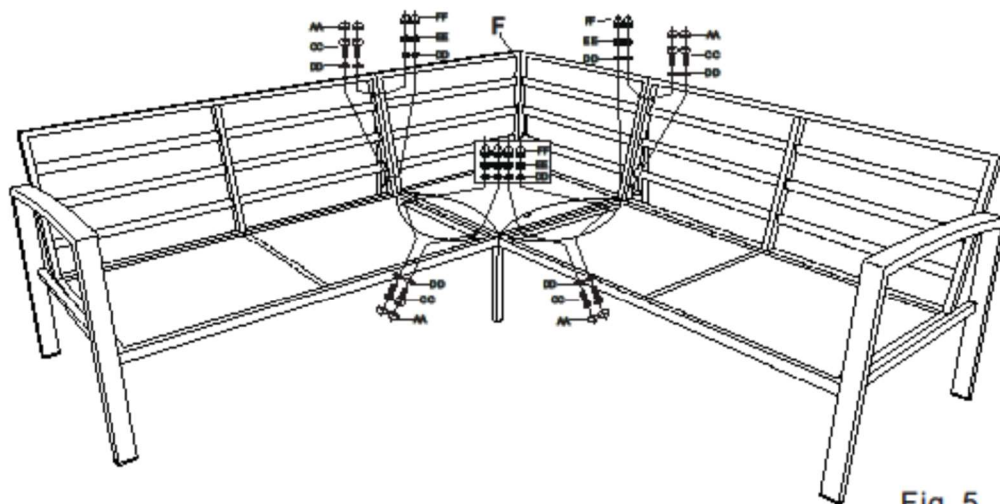

Fig. 5

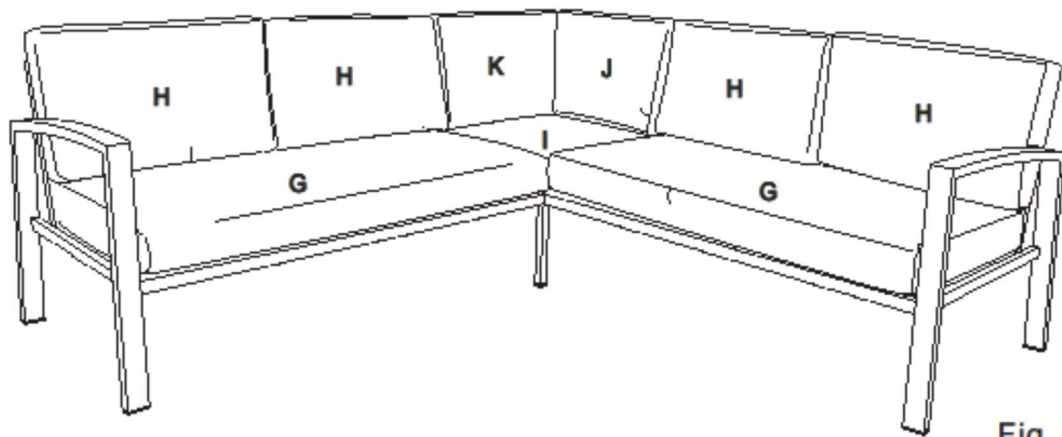

Fig. 6

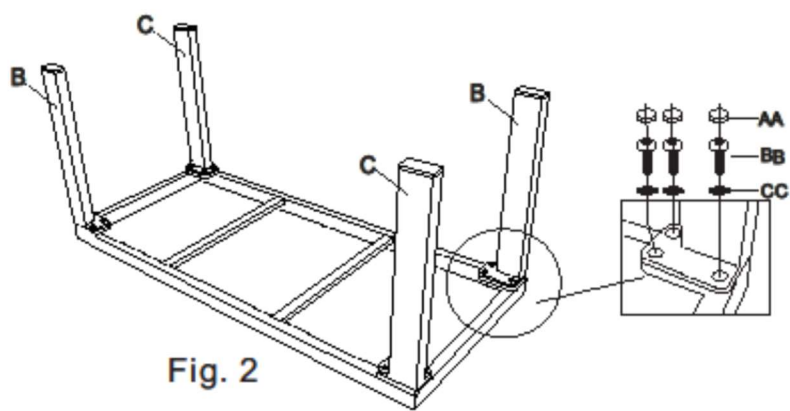

Fig. 2

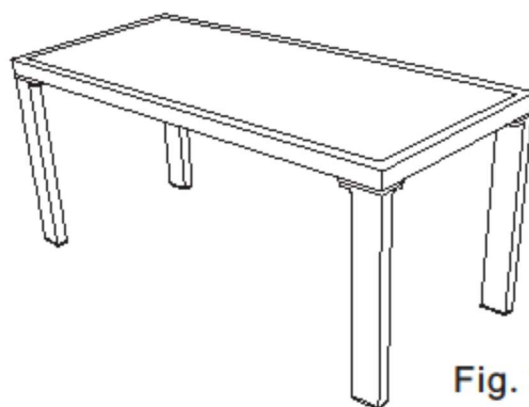

Fig. 3

ASSEMBLY INSTRUCTION OF TABLE

80330FG



Let op: Bij het monteren van het meubel eerst alle schroeven half indraaien.
Pas als alle schroeven op de plek zitten alles vast draaien.

Note: When assembling the furniture, first screw all screws halfway.
When all the screws are in place, tighten everything.

Achtung! Um die Montage des Möbelstückes zu vereinfachen,
erst alle Schrauben handfest andrehen und am Ende erst alle Schrauben
fest anziehen.

Attention: Avec votre meuble, tous les visser par rapidement monter.
Ci tout sur son place, vous pouvez les monter.

NO.	PARTS LIST	DESCRIPTION	QTY
A		GLASS	1
B		TABLERIM	1
C		LEG	4
AA		BOLT CAP(M6)	16
BB		BOLT (M6*15)	16
CC		WASHER(M6)	16
DD		ALLENKEY	1

