

15'

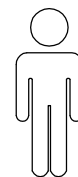
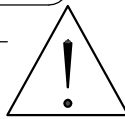
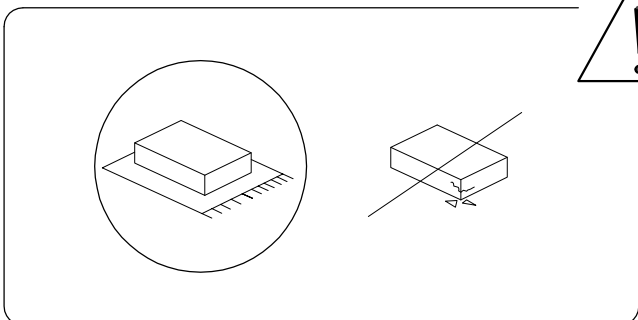

1

1/3

A

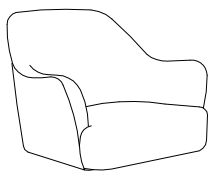

x 1

B

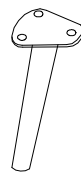

x 4

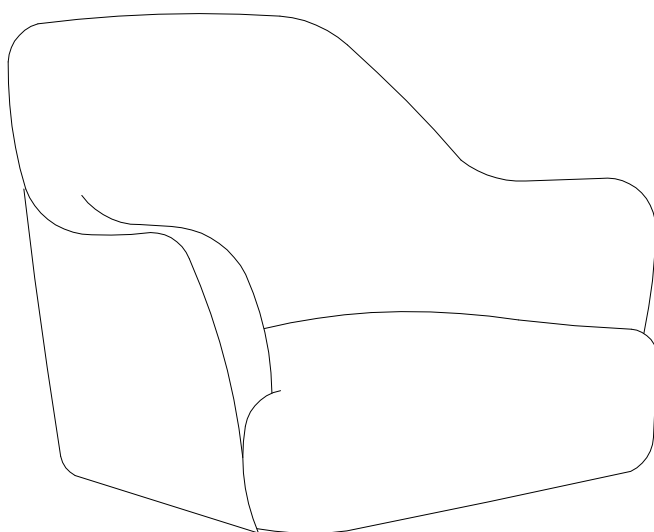

A

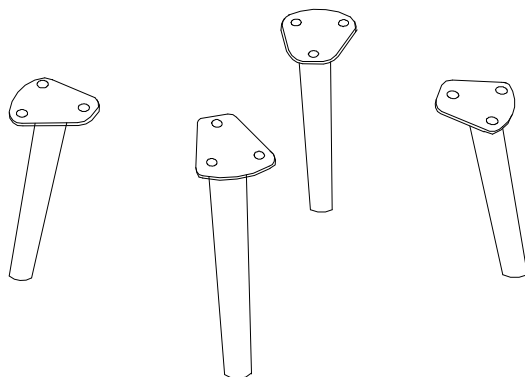

B x 4

C

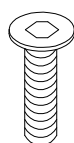

**M6
x
20**



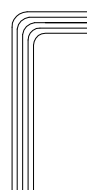

x 12

D



x 1

1

<p>A</p>  <p>x 1</p>	<p>B</p>  <p>x 4</p>	<p>C</p>  <p>M6 x 20 x 12</p>	<p>D</p>  <p>x 1</p>
--	--	--	--

