



# User Guide

AC2200 Smart Home Mesh Wi-Fi System  
Deco M9 Plus

# Contents

About This Guide .....	1	Advanced Features .....	23
Appearance .....	2	Online Upgrade .....	26
Set Up Your Deco .....	3	Managers .....	27
Dashboard .....	5		
Wi-Fi Settings .....	6		
Set Up Smart Home Devices .....	7		
Automation .....	9		
Shortcut .....	13		
Parental Controls .....	16		
Antivirus .....	18		
QoS .....	19		
Monthly Report .....	20		
Switch and Create Network .....	21		
Friends of Deco .....	22		



# About This Guide

This guide provides a brief introduction to AC2200 Smart Home Mesh Wi-Fi System and the Deco app, as well as regulatory information.

Please note that features of Deco may vary slightly depending on the model and software version you have, and on your location, language and internet service provider. All images, parameters and descriptions documented in this guide are used for demonstration only.

## Conventions

In this guide, the following conventions are used:

Convention	Description
Deco	Stands for AC2200 Smart Home Mesh Wi-Fi System/Unit.
<u>Underline</u>	Hyperlinks are in teal and underlined. You can click to redirect to a website or a specific section.
Teal	Key information appears in teal, including management page text such as menus, items, buttons and so on.
 Note:	Ignoring this type of note might result in a malfunction or damage to the device.
 Tips:	Indicates important information that helps you make better use of your device.

## More Info

- Specific product information can be found on the product page at <http://www.tp-link.com>.
- A Technical Support Forum is provided for you to discuss our products at <http://forum.tp-link.com>.
- Our Technical Support contact information can be found at the [Help](#) center of the Deco app and the [Contact Technical Support](#) page at <http://www.tp-link.com/support>.

# Appearance

Each Deco has an LED that changes color according to its status, two RJ-45 Ethernet ports and a power slot. See the explanation below:

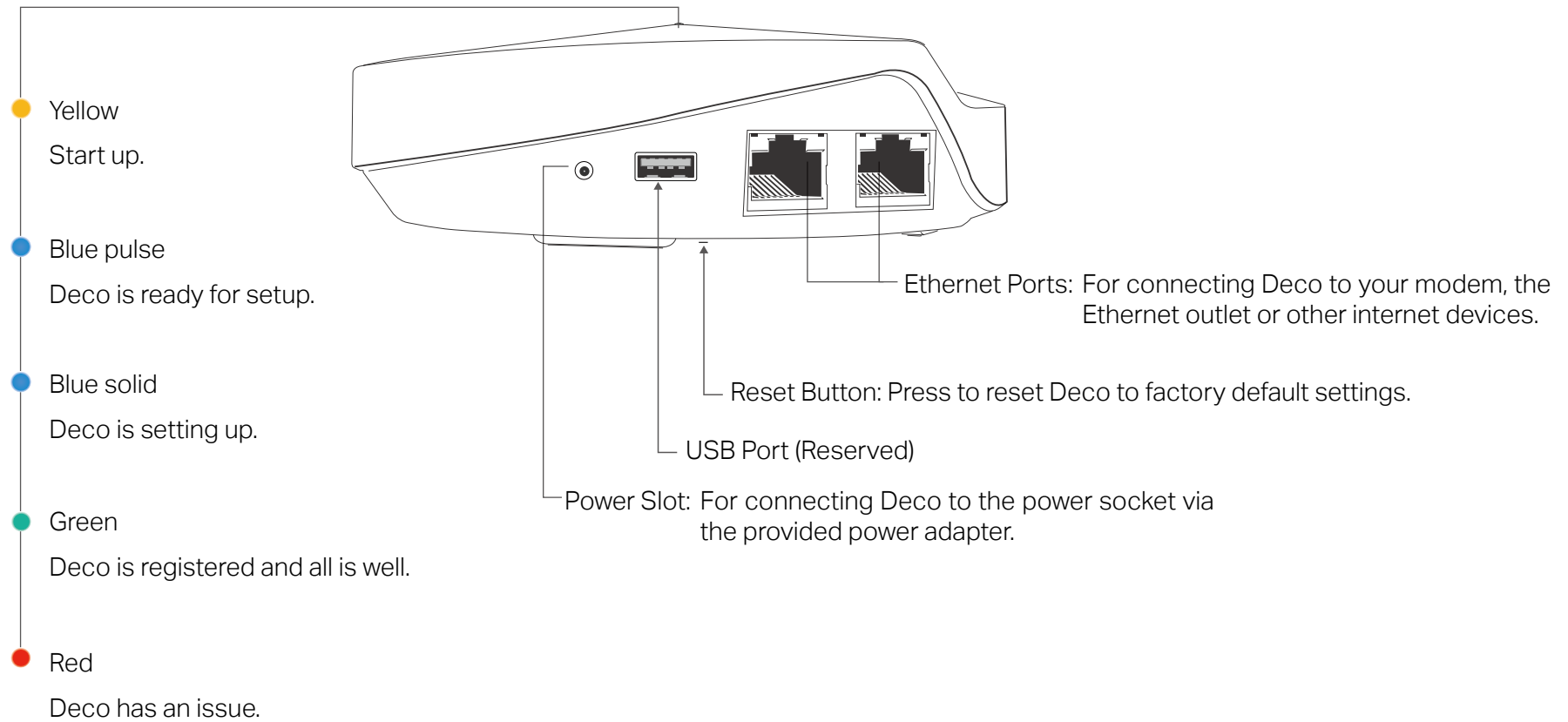

# Set Up Your Deco

Follow the steps below to set up your AC2200 Smart Home Mesh Wi-Fi System.

## 1. Download and install the TP-Link Deco app

Scan the QR code below or go to Google Play or the Apple App Store to download the Deco app.

Install the app on your Android or iOS smartphone or tablet.



or



## 2. Log in or sign up with TP-Link ID

Open the app. Use your TP-Link ID to log in.

If you don't have a TP-Link ID, tap SIGN UP. The Deco app will guide you through the rest.



## 3. Connect your modem to Deco

Find and power off your modem. Connect your Deco to the modem and power them both on.

If you don't have a modem, connect the Ethernet outlet directly to your Deco.



# Set Up Your Deco

Follow the steps below to set up your AC2200 Smart Home Mesh Wi-Fi System.

## 4. Select a location

Select a location for this Deco. If its location is not listed, you can create a new one by choosing Custom.

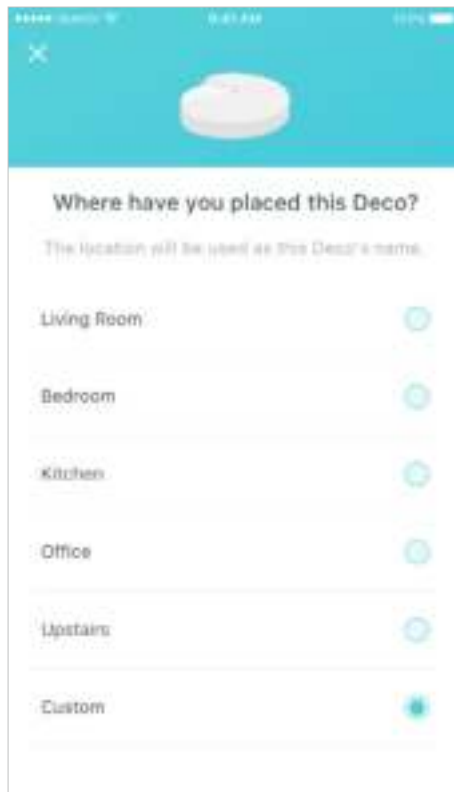

## 5. Create your Wi-Fi network

Set a network name and a password. These will be the name and password you use to connect your devices to Wi-Fi.



## 6. Add more Decos

You can add more Decos to expand Wi-Fi coverage. The app will guide you through the process of adding more Decos one by one.

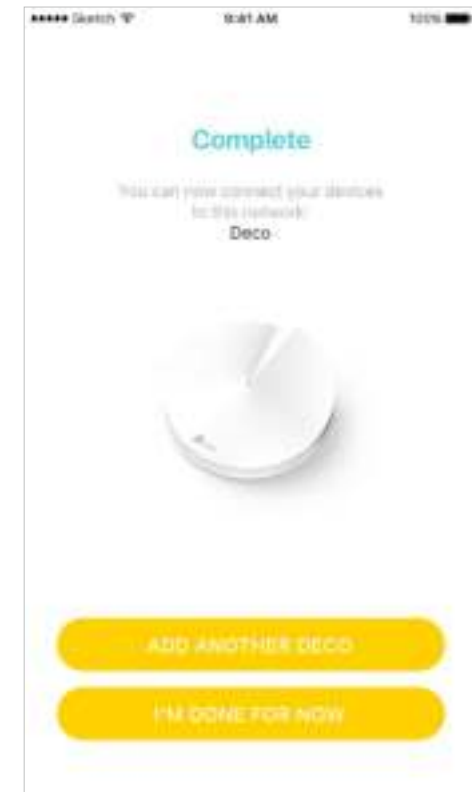

# Dashboard

After you successfully set up your Deco network, you will see the dashboard of the Deco app. Here you can view the working status of all Decos, test the internet speed, check the connected devices and manage your network.

Deco Status & Devices



Swipe right



Tap MORE



# Wi-Fi Settings

Customize the network name and password of your main network or create a separate network just for guests. You can set a guest network name and an easy-to-remember password. You can shake your device to share the network details easily with family and friends.

Enable a guest network



Create the network name and password

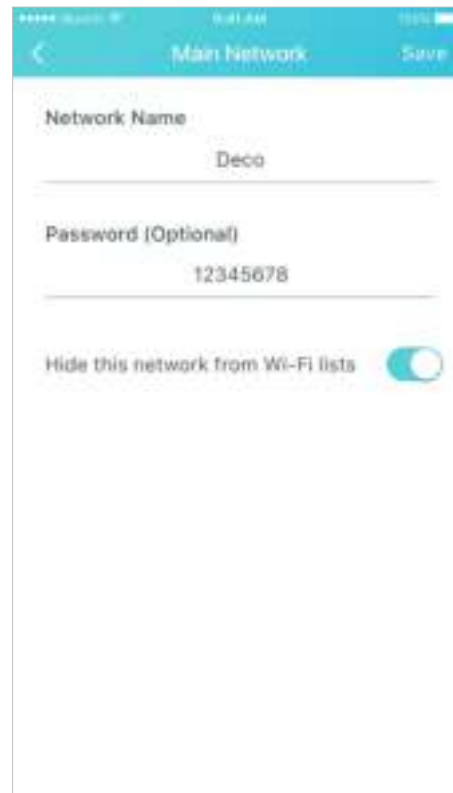

Shake to share

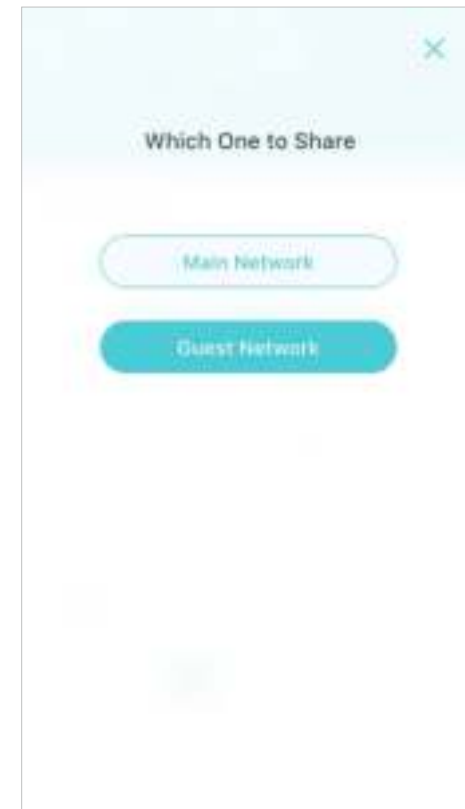



# Set Up Smart Home Devices

Deco M9 Plus not only delivers seamless wireless connectivity, but also acts as a smart home control point, letting you replace your older smart hubs. It connects Wi-Fi, ZigBee and Bluetooth devices to your network and lets you manage them from the Deco App. Whether you're on the couch or on the go, you're always in reach of your lights, thermostats, switches and door locks. Follow the steps below to add smart home devices to your Deco network.

1. On the Dashboard page, tap ⊕.



2. Tap SMART DEVICES.

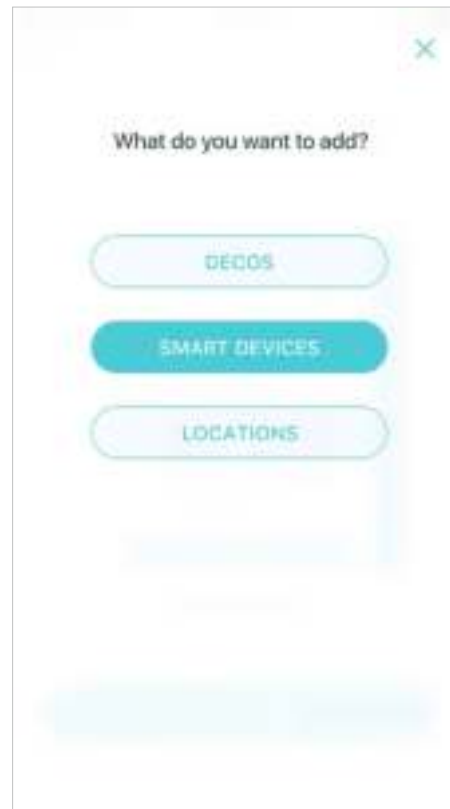

3. Select the smart device type.

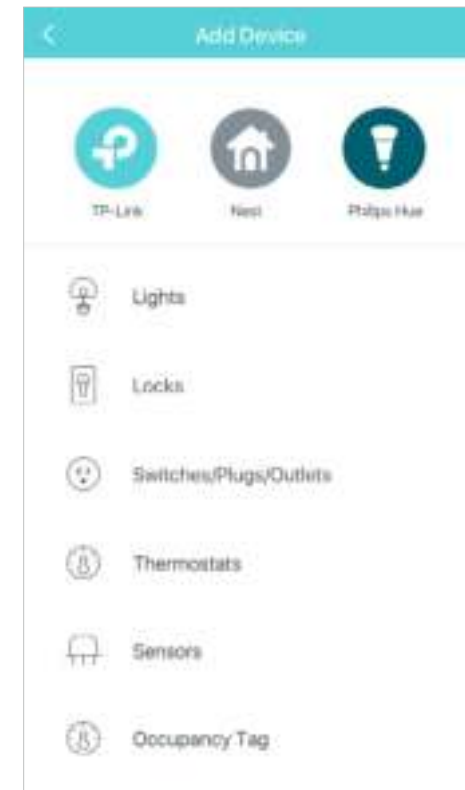

# Set Up Smart Home Devices

Follow the steps below to add smart home devices to your Deco network.

4. Select your smart device. If not listed, select Other Light, for example.

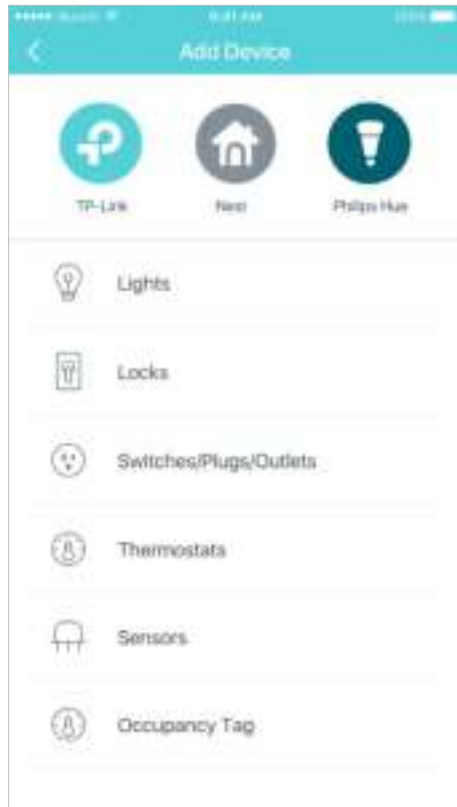

5. Follow the app's guide to find your smart device(s).

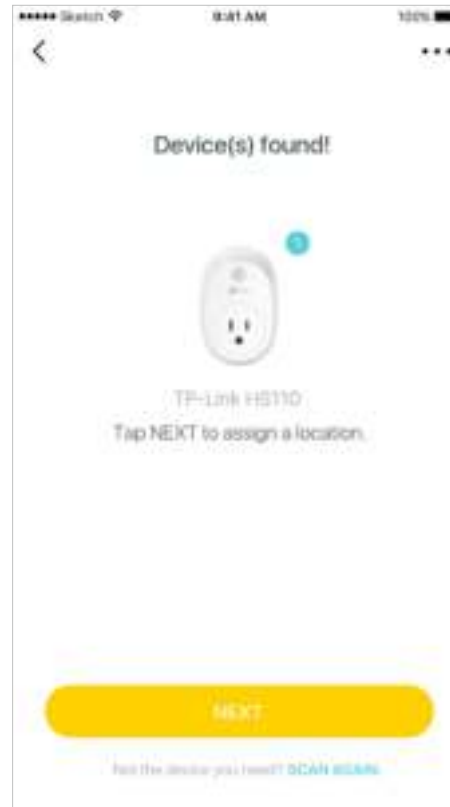

6. Assign a location for your device and tap Done.

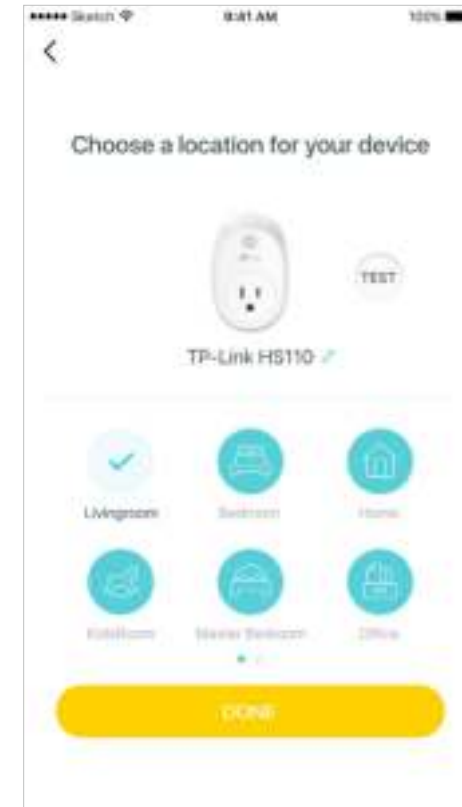

# Automation

Automation allows you to set interactions between your smart devices. For example, if the bedroom light comes on (which is a trigger), then the air conditioner in the bedroom will start running (which is an action). Follow the steps below to create an automation.

1. Tap Create or ⊕.



2. Specify the time when this automation will take effect.

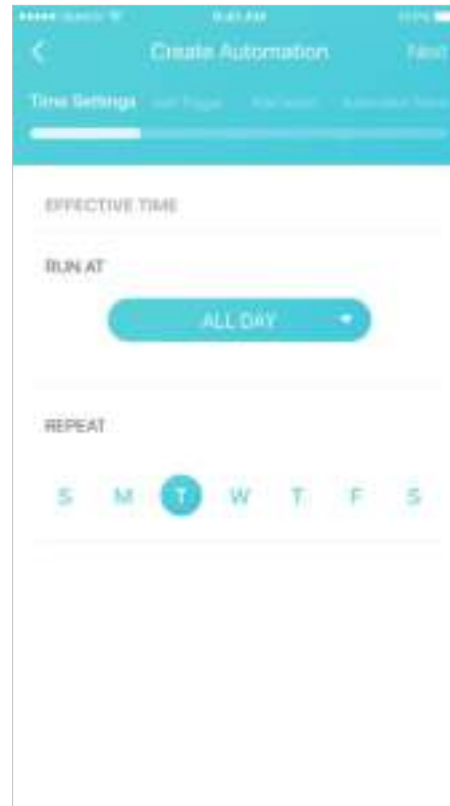

3. Follow the app's guide to add a trigger. If you set a specific time for the automation, then a trigger is optional.

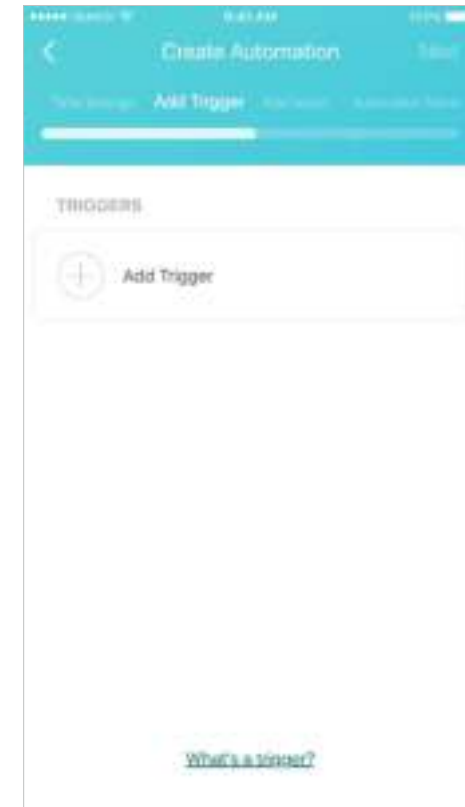

# Automation

Follow the steps below to create an automation.

4. Follow the app's guide to add an action.

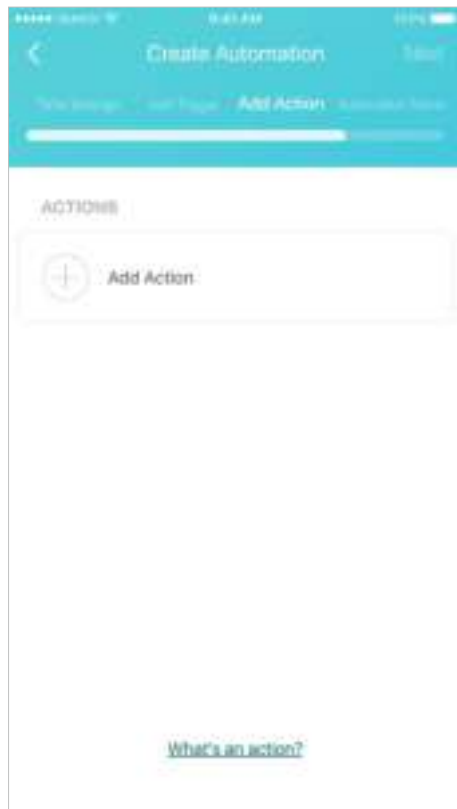

You can delay an action when triggers are fired by setting the delay action .



5. Describe the automation and tap Done.



# Automation

Automation allows you to set interactions between your smart devices. For example, if the bedroom light comes on (which is a trigger), then the air conditioner in the bedroom will start running (which is an action).

How trigger and action work



The automations you created are displayed here.

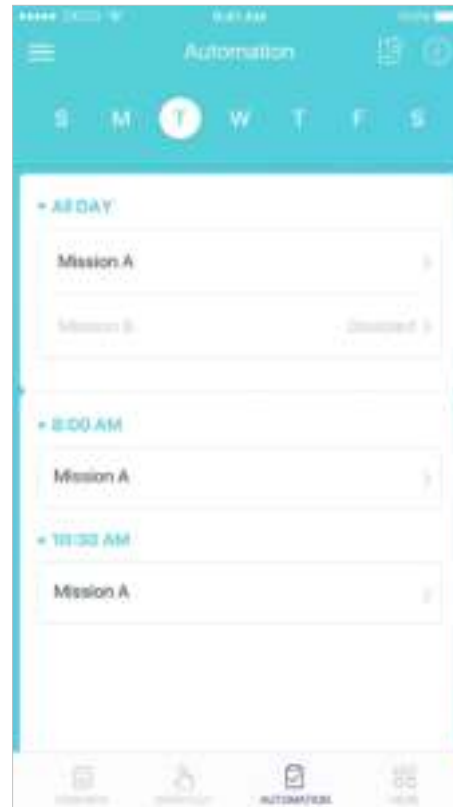

Tap an automation to delete, enable or disable it. You can also delete, edit or tap ⊕ to add triggers and actions.



# Automation

Automation allows you to set interactions between your smart devices. For example, if the bedroom light comes on (which is a trigger), then the air conditioner in the bedroom will start running (which is an action).

When multiple devices are selected for a trigger, then you have to specify the trigger type.



# Shortcut

With the tap of an icon, execute a shortcut you created. Follow the steps below to create a shortcut.

1. Tap Create or .



2. Select the shortcut type.

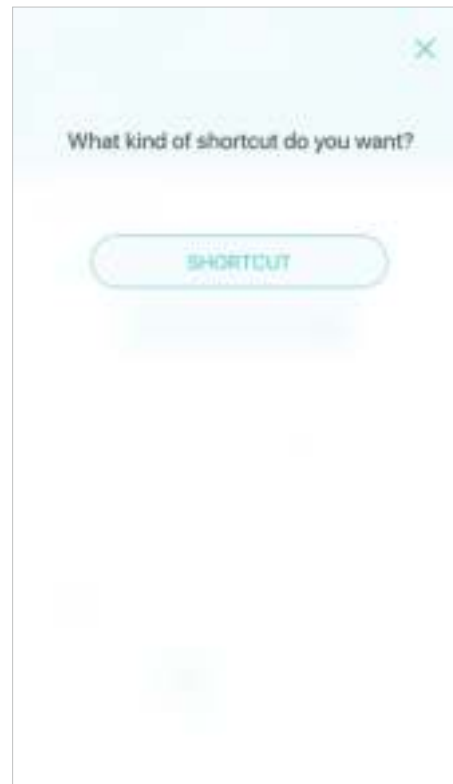

# Shortcut

Follow the steps below to create a shortcut.

3. Follow the app's guide to add an action.

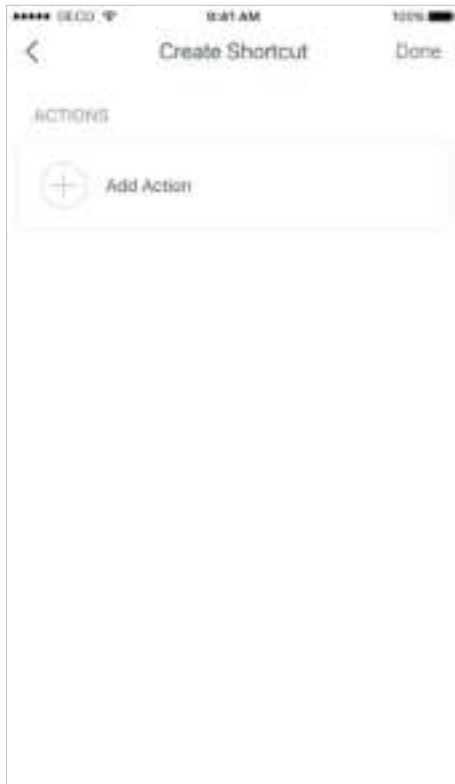

4. If needed, you can add more actions for one shortcut. And tap Done.

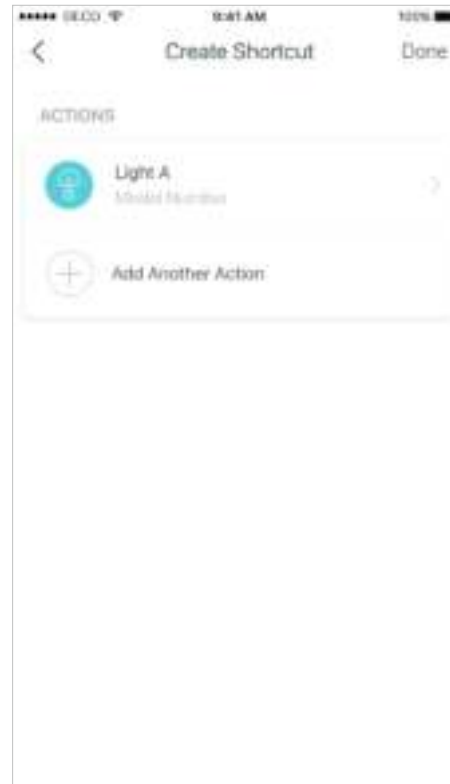

5. Select an icon for the shortcut and describe it.





# Shortcut

With the tap of an icon, execute a shortcut you created.

Shortcut executed

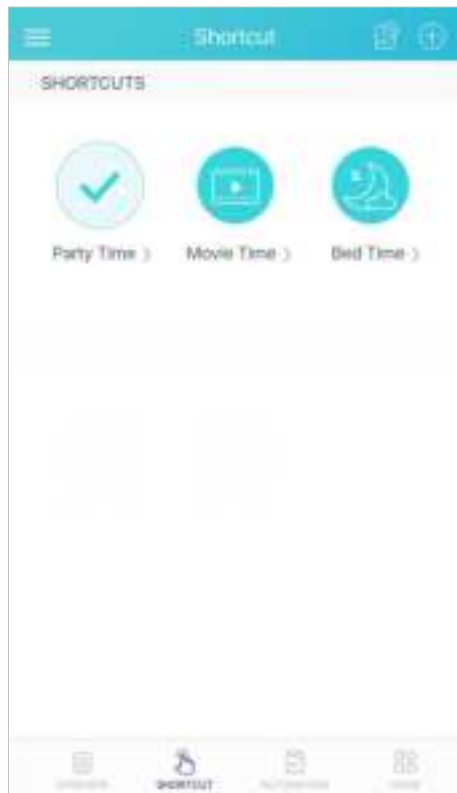

# Parental Controls

Create profiles for family members and specify the devices that belong to each. Set individualized parental controls including when and for how long each person can access the internet. Block inappropriate content and pause the internet. Follow the steps below to set up parental controls.

1. Tap ADD PROFILE to create a new profile.

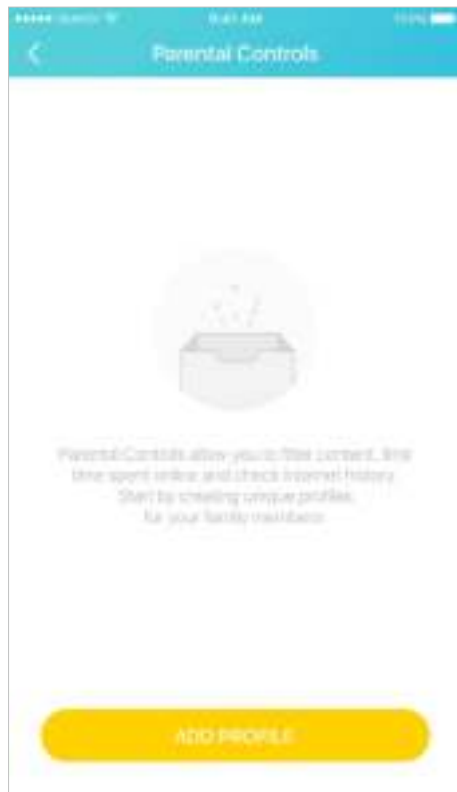

2. Set filter level.

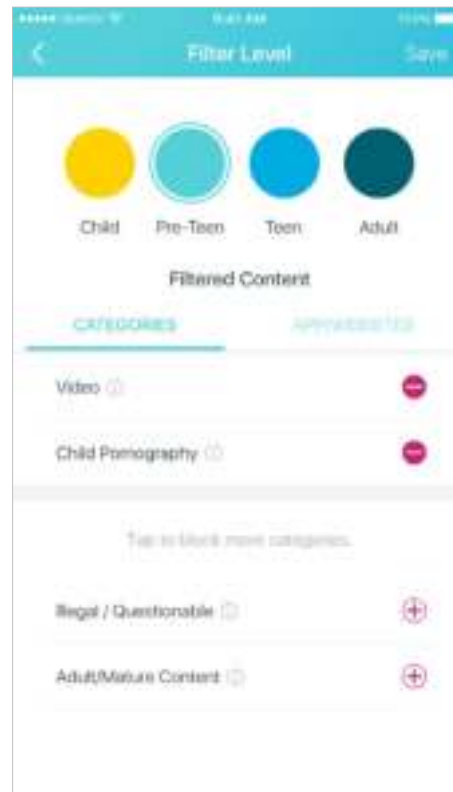

3. Set time controls.

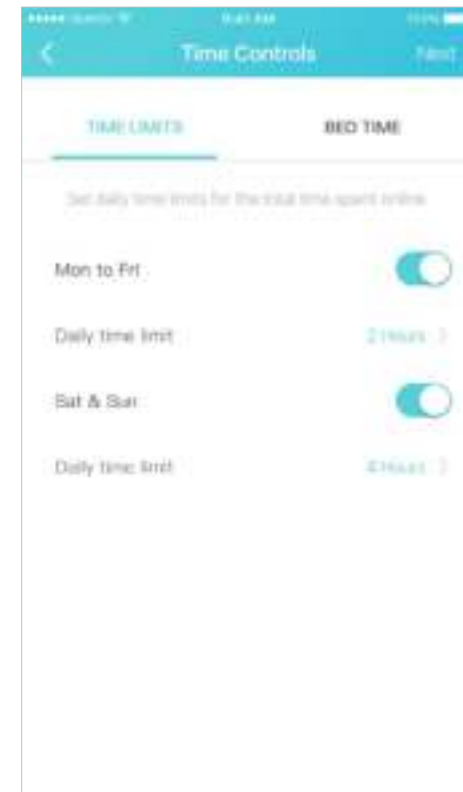

# Parental Controls

Follow the steps below to set parental controls.

4. Add devices to this profile and tap Done.

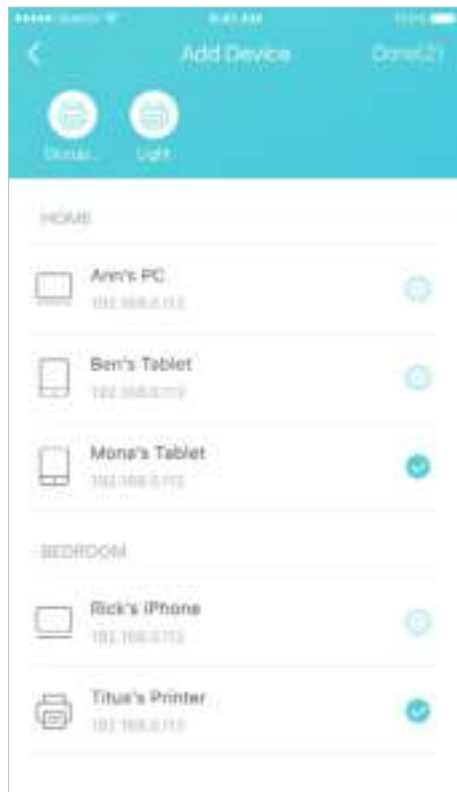

# Antivirus

There are three ways Deco ensures your home network remains safe: by blocking malicious websites, by protecting the system and applications against external attacks and eliminating vulnerabilities, and by preventing infected devices from sending sensitive information outside your network.

Protection enabled



Alert history

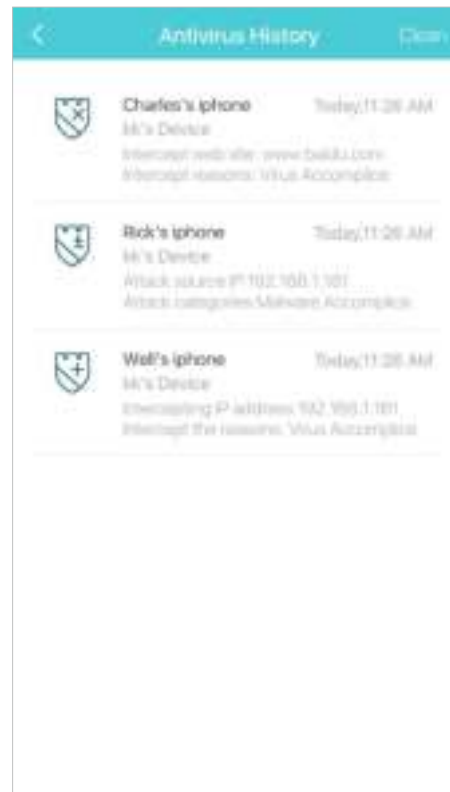

Protection disabled

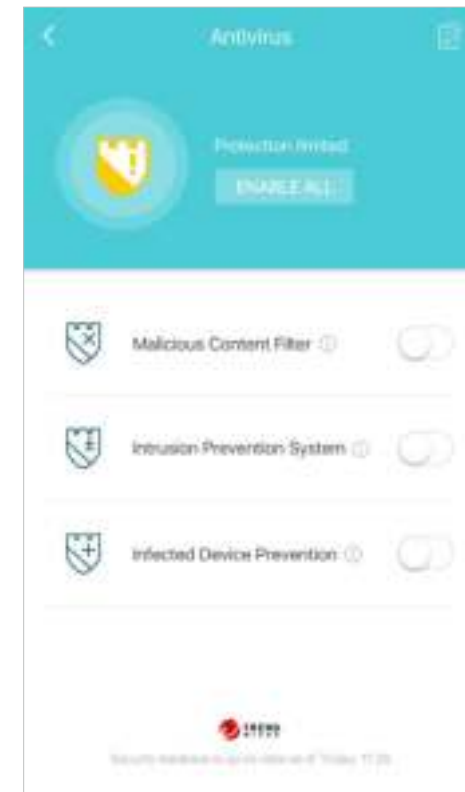

# QoS

There are two ways to use the QoS (Quality of Service) function. You can prioritize the connection of a particular device for a set duration, such as a family member's laptop for one hour during a video call. You can also prioritize the online activity that's most important to the whole family, such as Streaming or Gaming.

Prioritize a device



Prioritize an activity

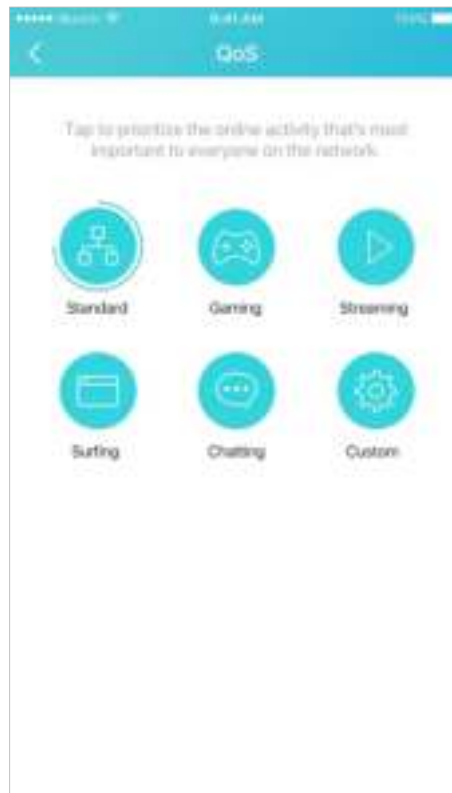

Customize

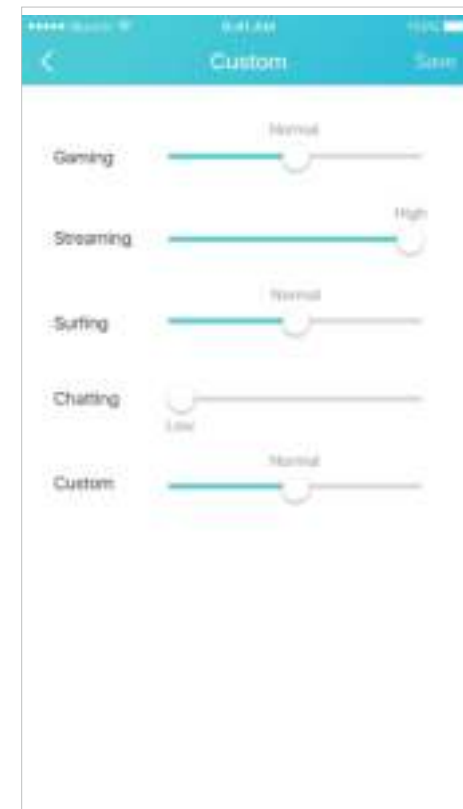

# Monthly Report

Review a monthly list of usage, top 5 visited content, most frequently executed automations and shortcuts, and security threats.

Safeguard your Deco network



Top 5 visited content under Parental Controls

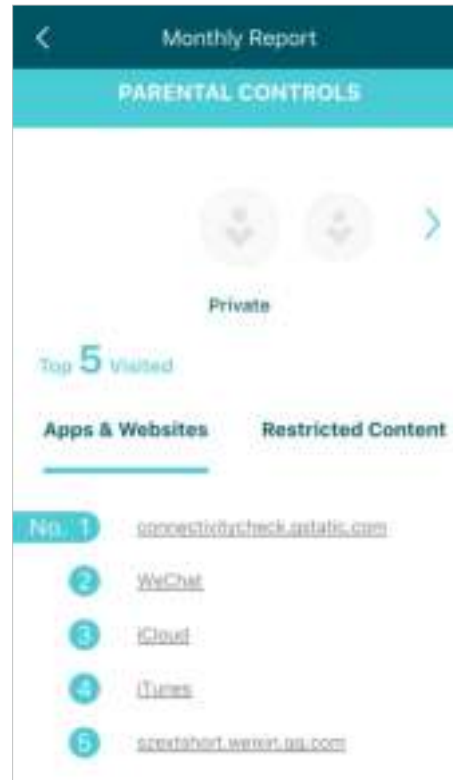

Most frequently executed Shortcut and Automation

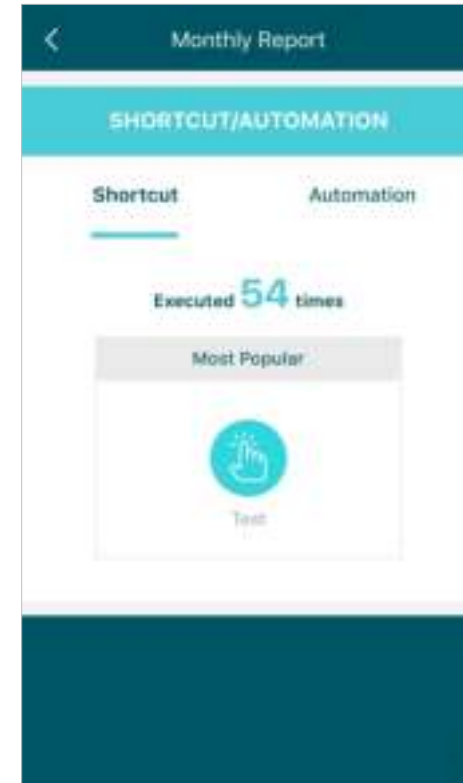

# Switch and Create Network

You can create, manage and switch between different Deco networks bound to your TP-Link ID.

Swipe right and tap ⇌



Swipe to switch a network to manage



Swipe to create a new network

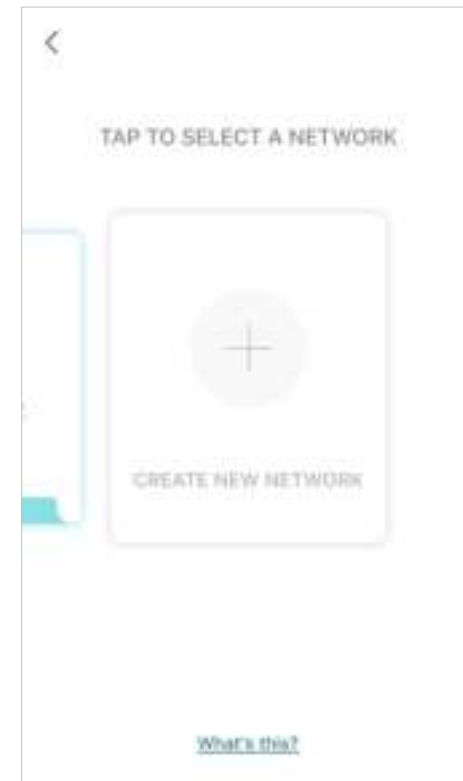

# Friends of Deco

TP-Link works with Alexa. With Alexa, you can use your voice to control functions of the AC2200 Tri-Band Mesh Wi-Fi System.

Friends of Deco





# Advanced Features

Additional features are available under the Advanced menu. You can modify WAN settings (IPv4 & IPv6), control Deco's LED, turn notifications off and on, create a domain name for your Deco, set up port forwarding rules to make your local computers accessible to other devices over the internet, reserve an IP address for a specific device and change the operating mode.

IPv4



IPv6



LED Control



Register a TP-Link DDNS domain name

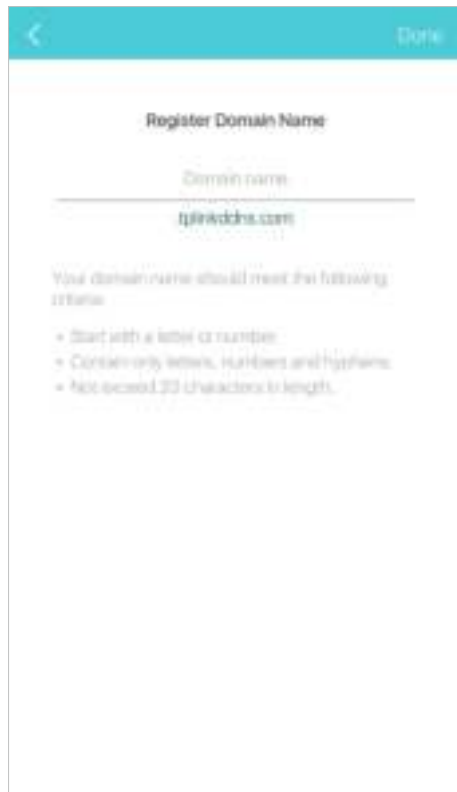

Enable or disable TP-Link DDNS feature



Set up port forwarding rules



Reserve IP addresses for specific devices

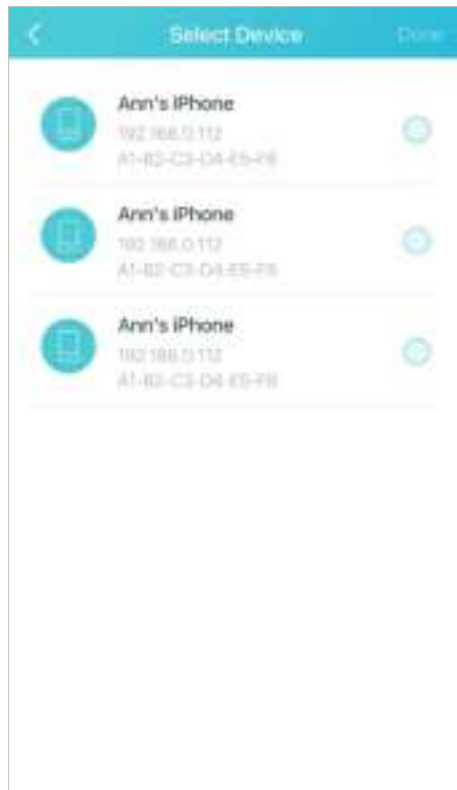

Change the operating mode



# Online Upgrade

TP-Link is dedicated to improving product features and providing a better customer experience. Update Deco when prompted in the Deco app.

Download new firmware



Install new firmware

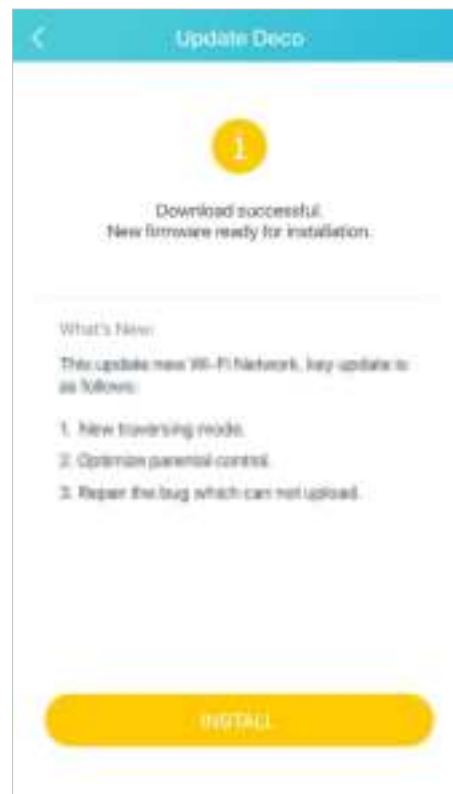

Up-to-date



# Managers

Add friends and family members to help manage your network. Each manager should have their own TP-Link ID.

Add as manager

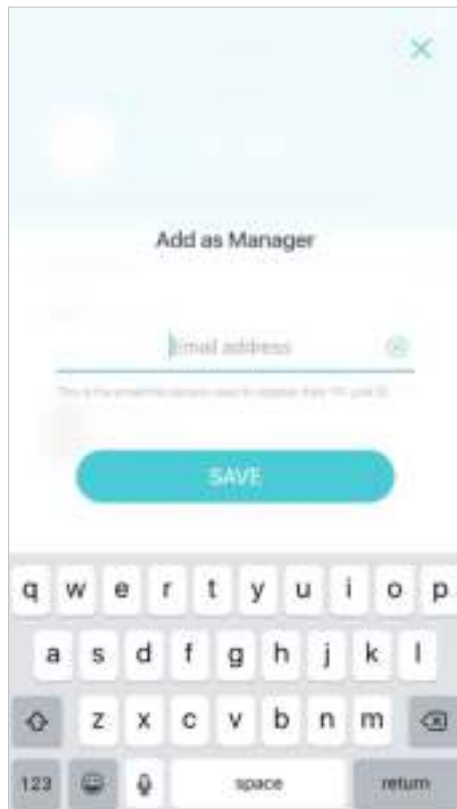

Manager list

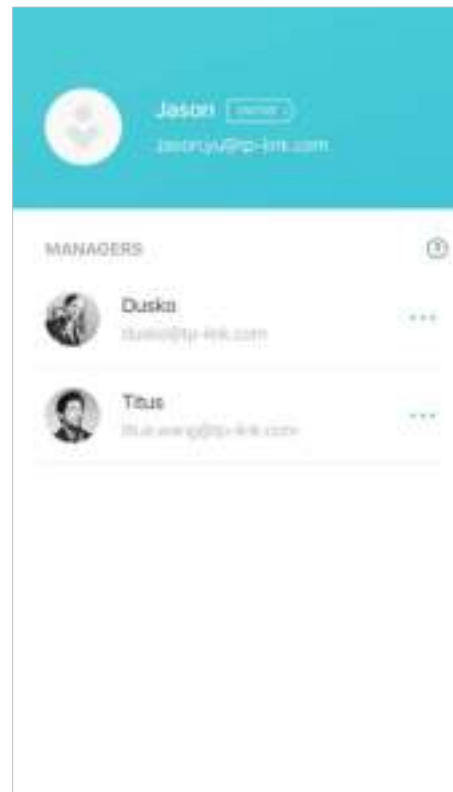

Remove a manager

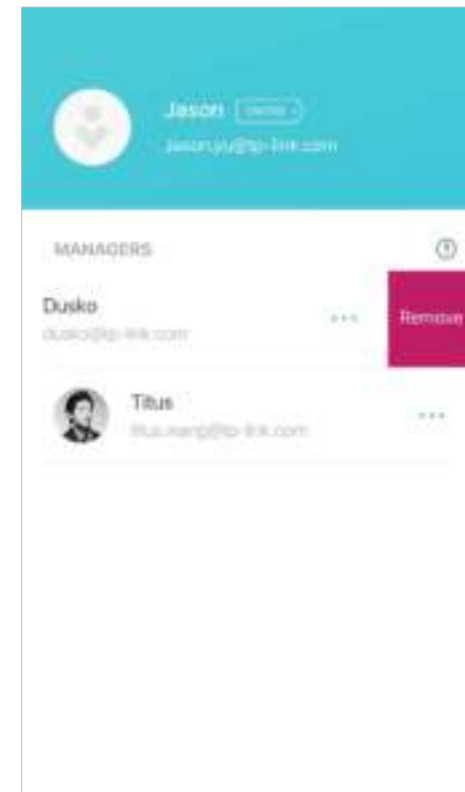

# Authentication

## COPYRIGHT & TRADEMARKS

Specifications are subject to change without notice.  tp-link is a registered trademark of TP-Link Technologies Co., Ltd. Other brands and product names are trademarks or registered trademarks of their respective holders.

No part of the specifications may be reproduced in any form or by any means or used to make any derivative such as translation, transformation, or adaptation without permission from TP-Link Technologies Co., Ltd. Copyright © 2020 TP-Link Technologies Co., Ltd. All rights reserved.

## FCC STATEMENT



**Product Name:** AC2200 Smart Home Mesh Wi-Fi System

**Model Number:** Deco M9 Plus

Component Name	Model
I.T.E POWER SUPPLY	T120200-2B4

### **Responsible party:**

**TP-Link USA Corporation, d/b/a TP-Link North America, Inc.**

Address: 145 South State College Blvd. Suite 400, Brea, CA 92821

Website: <http://www.tp-link.com/us/>

Tel: +1 626 333 0234

Fax: +1 909 527 6803

E-mail: [sales.usa@tp-link.com](mailto:sales.usa@tp-link.com)

This equipment has been tested and found to comply with the limits for a Class B digital device, pursuant to part 15 of the FCC Rules. These limits are designed to provide reasonable protection against harmful interference in a residential installation. This equipment generates, uses and can radiate radio frequency energy and, if not installed and used in accordance with the instructions, may cause harmful interference to radio communications. However, there is no guarantee that interference will not occur in a particular installation. If this equipment does cause harmful interference to radio or television reception, which can be determined by turning the equipment off and on, the user is encouraged to try to correct the interference by one or more of the following measures:

- Increase the separation between the equipment and receiver.
- Connect the equipment into an outlet on a circuit different from that to which the receiver is connected.

This device complies with part 15 of the FCC Rules. Operation is subject to the following two conditions:

1. This device may not cause harmful interference.
2. This device must accept any interference received, including interference that may cause undesired operation.

Any changes or modifications not expressly approved by the party responsible for compliance could void the user's authority to operate the equipment.

Note: The manufacturer is not responsible for any radio or TV interference caused by unauthorized modifications to this equipment. Such modifications could void the user's authority to operate the equipment.

### **FCC RF Radiation Exposure Statement**

This equipment complies with FCC RF radiation exposure limits set forth for an uncontrolled environment. This device and its antenna must not be co-located or operating in conjunction with any other antenna or transmitter.

"To comply with FCC RF exposure compliance requirements, this grant is applicable to only Mobile Configurations. The antennas used for this transmitter must be installed to provide a separation distance of at least 20 cm from all persons and must not be co-located or operating in conjunction with any other antenna or transmitter."

We, TP-Link USA Corporation, has determined that the equipment shown as above has been shown to comply with the applicable technical standards, FCC part 15. There is no unauthorized change is made in the equipment and the equipment is properly maintained and operated.

Issue Date: 2020-02-25

### **FCC compliance information statement**



**Product Name:** I.T.E POWER SUPPLY

**Model Number:** T120200-2B4

**Responsible party:**

**TP-Link USA Corporation, d/b/a TP-Link North America, Inc.**

Address: 145 South State College Blvd. Suite 400, Brea, CA 92821

Website: <http://www.tp-link.com/us/>

Tel: +1 626 333 0234

Fax: +1 909 527 6803

E-mail: [sales.usa@tp-link.com](mailto:sales.usa@tp-link.com)



This equipment has been tested and found to comply with the limits for a Class B digital device, pursuant to part 15 of the FCC Rules. These limits are designed to provide reasonable protection against harmful interference in a residential installation. This equipment generates, uses and can radiate radio frequency energy and, if not installed and used in accordance with the instructions, may cause harmful interference to radio communications. However, there is no guarantee that interference will not occur in a particular installation. If this equipment does cause harmful interference to radio or television reception, which can be determined by turning the equipment off and on, the user is encouraged to try to correct the interference by one or more of the following measures:

- Reorient or relocate the receiving antenna.
- Increase the separation between the equipment and receiver.
- Connect the equipment into an outlet on a circuit different from that to which the receiver is connected.
- Consult the dealer or an experienced radio/ TV technician for help.

This device complies with part 15 of the FCC Rules. Operation is subject to the following two conditions:

- 1) This device may not cause harmful interference.
- 2) This device must accept any interference received, including interference that may cause undesired operation.

Any changes or modifications not expressly approved by the party responsible for compliance could void the user's authority to operate the equipment.

We, TP-Link USA Corporation, has determined that the equipment shown as above has been shown to comply with the applicable technical standards, FCC part 15. There is no unauthorized change is made in the equipment and the equipment is properly maintained and operated.

Issue Date: 2020-02-25

### CE Mark Warning



This is a class B product. In a domestic environment, this product may cause radio interference, in which case the user may be required to take adequate measures.

### OPERATING FREQUENCY(the maximum transmitted power)

2412MHz—2472MHz(20dBm) 2402MHz—2480MHz(10dBm) 2405MHz—2480MHz(12dBm)

5150MHz—5250MHz(23dBm) 5470MHz—5725MHz(except for 5600-5650MHz)(30dBm)

## EU declaration of conformity

TP-Link hereby declares that the device is in compliance with the essential requirements and other relevant provisions of directives 2014/53/EU, 2009/125/EC, 2011/65/EU and (EU)2015/863.

The original EU declaration of conformity may be found at <https://www.tp-link.com/en/ce>

## RF Exposure Information

This device meets the EU requirements (2014/53/EU Article 3.1a) on the limitation of exposure of the general public to electromagnetic fields by way of health protection.

The device complies with RF specifications when the device used at 20 cm from your body.

Restricted to indoor use.

## Canadian Compliance Statement

This device complies with Industry Canada license-exempt RSS standard(s). Operation is subject to the following two conditions:

1. This device may not cause interference, and
2. This device must accept any interference, including interference that may cause undesired operation of the device.

Le présent appareil est conforme aux CNR d'Industrie Canada applicables aux appareils radio exempts de licence. L'exploitation est autorisée aux deux conditions suivantes :

1. l'appareil ne doit pas produire de brouillage;
2. l'utilisateur de l'appareil doit accepter tout brouillage radioélectrique subi, même si le brouillage est susceptible d'en compromettre le fonctionnement

## Caution:

1. The device for operation in the band 5150–5250 MHz is only for indoor use to reduce the potential for harmful interference to co-channel mobile satellite systems;
2. For devices with detachable antenna(s), the maximum antenna gain permitted for devices in the band 5725-5850 MHz shall be such that the equipment still complies with the e.i.r.p. limits specified for point-to-point and non-point-to-point operation as appropriate; and

The high-power radars are allocated as primary users (i.e. priority users) of the bands 5250-5350 MHz and 5650-5850 MHz and that these radars could cause interference and/or damage to LE-LAN devices.

### **Avertissement:**

1. Le dispositif fonctionnant dans la bande 5150-5250 MHz est réservé uniquement pour une utilisation à l'intérieur afin de réduire les risques de brouillage préjudiciable aux systèmes de satellites mobiles utilisant les mêmes canaux;
2. Le gain maximal d'antenne permis pour les dispositifs avec antenne(s) amovible(s) utilisant la bande 5725-5850 MHz doit se conformer à la limitation P.I.R.E spécifiée pour l'exploitation point à point et non point à point, selon le cas.

En outre, les utilisateurs devraient aussi être avisés que les utilisateurs de radars de haute puissance sont désignés utilisateurs principaux (c.-à-d., qu'ils ont la priorité) pour les bandes 5745-5850 MHz et que ces radars pourraient causer du brouillage et/ou des dommages aux dispositifs LAN-EL.

### **Radiation Exposure Statement:**

This equipment complies with IC radiation exposure limits set forth for an uncontrolled environment. This equipment should be installed and operated with minimum distance 20cm between the radiator & your body.

### **Déclaration d'exposition aux radiations:**

Cet équipement est conforme aux limites d'exposition aux rayonnements IC établies pour un environnement non contrôlé. Cet équipement doit être installé et utilisé avec un minimum de 20 cm de distance entre la source de rayonnement et votre corps.

### **Industry Canada Statement**

CAN ICES-3 (B)/NMB-3(B)

### **Korea Warning Statements:**

당해 무선설비는 운용중 전파혼신 가능성이 있음.



Продукт сертифіковано згідно с правилами системи УкрСЕПРО на відповідність вимогам нормативних документів та вимогам, що передбачені чинними законодавчими актами України.





## Safety Information

- Keep the device away from water, fire, humidity or hot environments.
- Do not attempt to disassemble, repair, or modify the device.
- Do not use damaged charger or USB cable to charge the device.
- Do not use any other chargers than those recommended
- Do not use the device where wireless devices are not allowed.
- Adapter shall be installed near the equipment and shall be easily accessible.
-  Use only power supplies which are provided by manufacturer and in the original packing of this product. If you have any questions, please don't hesitate to contact us.

Please read and follow the above safety information when operating the device. We cannot guarantee that no accidents or damage will occur due to improper use of the device. Please use this product with care and operate at your own risk.

## Explanation of the symbols on the product label

Symbol	Explanation
	DC voltage
	Indoor use only
	RECYCLING This product bears the selective sorting symbol for Waste electrical and electronic equipment (WEEE). This means that this product must be handled pursuant to European directive 2012/19/EU in order to be recycled or dismantled to minimize its impact on the environment. User has the choice to give his product to a competent recycling organization or to the retailer when he buys a new electrical or electronic equipment.