

User Manual

Wireless Personal Speaker

Model No.: BTSP-NB05







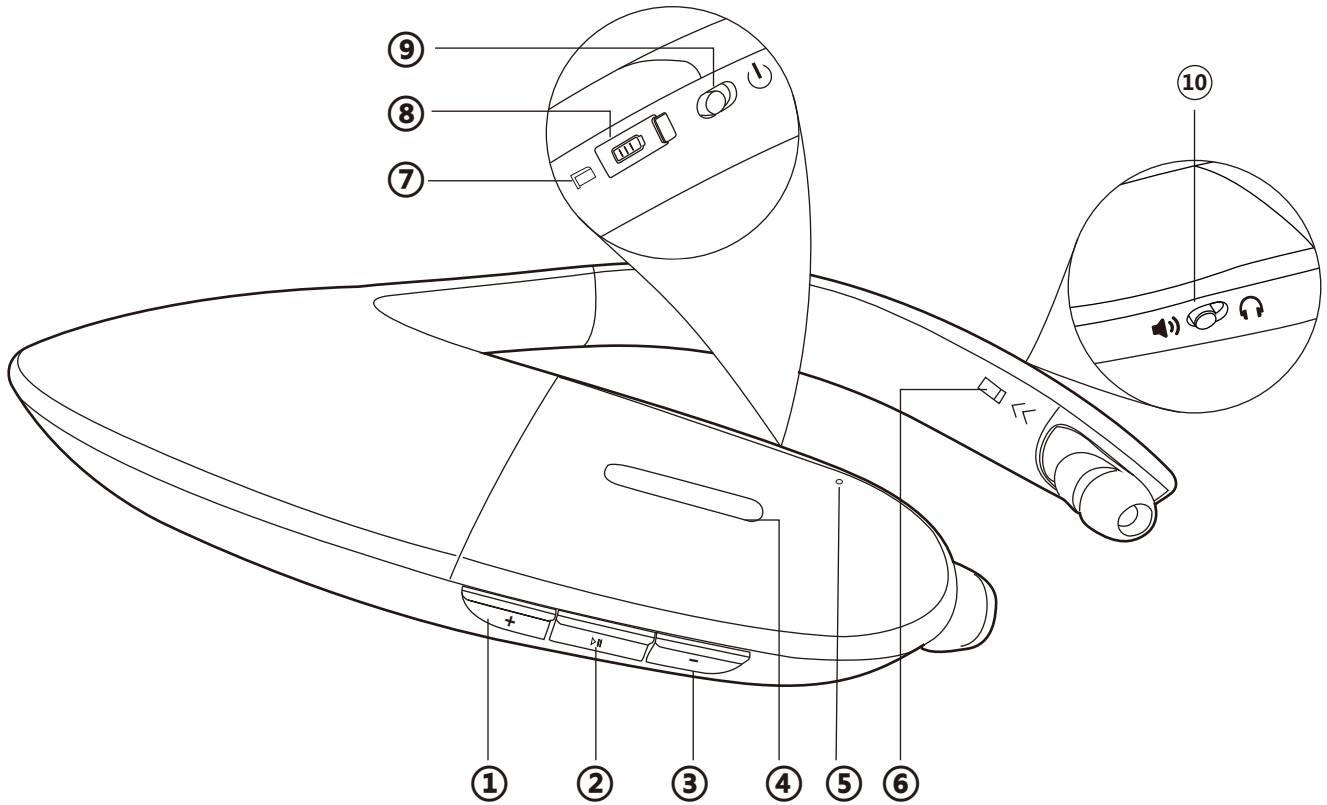





Product overview.....	1
Basic operation.....	2
LED indicators.....	2
Voice prompts	3
Connect to a Bluetooth device.....	3
Connect with two Bluetooth devices simultaneously	4
Reconnect to Bluetooth device.....	4
Factory Reset / Clear pairing history	4
Charging.....	4

Product Overview



1. Volume up
2. Multi-function button
3. Volume down
4. LED indicator
5. Microphone
6. Retractable earbud control (L)
7. Retractable earbud control (R)
8. Charging port
9. Power/off
10. Speaker/earphone mode switch

Basic operation

Function	Operation
General function	
Power on/off	Slide power switch to  position for 1 second
Pair	Press and hold  for 5 seconds
Switch between speaker and earphone	Slide Speaker/earphone mode switch to  / 
Retract the earphone	Click  to retract the earphone
Music control	
Play/pause	Click  once
Volume up/down	Click +/- once
Next/previous track	Press and hold +/-
Call control	
Answer/enda call	Click  once
Reject a call	Press and hold 
Activate Siri	Double click 
End the 1st call to answer the 2nd call	Click  once

LED indicators

Status	LED indicator
Pairing	LED flashes RED and BLUE alternately
Connected via aptX-HD Codec	Flash BLUE 4-times every 5 seconds
Connected via aptX-LL or FastStream Codec	Solid BLUE light
Connected via aptX Codec	Triple-Flash every 5 seconds
Connected via AAC Codec	Double-Flash every 5 seconds
Connected via SBC	Single-Flash every 5 seconds
Factory Reset / Clear pairing history	LED lights up RED and BLUE together (looks PINK) for 5 seconds
Low battery	LED flashes RED 4timesevery 5 minutes

Voice prompts

Status	LED indicator
Power on/off	"Power on""Power off"
Battery level	After power on: "Battery full""Battery level high" "Battery level medium" 30 minutes before running out of power: "Battery level low"
Connected	"Connected"
Factory Reset / Clear Pairing History	Two "beeps"
Disconnected manually	"Disconnected"
Beyond the range of connections	"Beyond the range of connections"
Highest volume	One "beep"
Lowest volume	"du"

Connect to a Bluetooth device

1. Enter the NB05 into **PAIRING MODE**–For 1st use, once turned on, NB05 will enter pairing mode automatically, LED flashes **RED** & **BLUE** with a"pairing" voice prompt.For non-1st use, press & hold **⌘** for 5 seconds to manually enter pairing mode.
2. On your device –Activate Bluetooth and select "AvantreeNB05" to connect.If you are using a Bluetooth transmitter, enter your transmitter into **PAIRING MODE** (Please refer to your transmitter's user manual).
3. Once connected, you'll hear a"connected" voice prompt from NB05.

Notes:

- The NB05 will automatically turn off if**
- 1) it fails to pair with another device within 2 minutes.
 - 2) it's kept out of connection range for over 10 minutes.

Connect with two Bluetooth devices simultaneously

1. Connect the NB05 to the FIRST device as shown above.
2. Enter the NB05 into PAIRING MODE again, your 1st device will disconnect from NB05. Then Activate Bluetooth and select "Avantree NB05" on your 2nd device to connect.
3. Now select "Avantree NB05" on your 1st device to connect to NB05.

NB05 is now connected with both of your devices.

Note: This feature only works for two mobile devices, such as cellphones and tablets. It doesn't work for PCs or Bluetooth transmitters.

Reconnect to Bluetooth device

Once powered on, the NB05 should automatically reconnect to the most recently connected device within 5 seconds. If it can't reconnect within 5 seconds, please select "Avantree NB05" on your device to connect manually. (If you're using a Bluetooth transmitter, please refer to its user manual.)

Factory Reset / Clear pairing history

You may need to factory reset the NB05 when you experience short range, audio cuts, or cannot reconnect/pair.

Turn on the NB05. Press and hold the "+" and the "-" buttons together for 5 seconds, the LED indicator will light up RED and BLUE together (looks PINK) for 5 seconds, and you'll hear two "beeps". Now the NB05 has been successfully reset and will enter pairing mode automatically with the LED indicator flashing RED and BLUE alternately.

Charging

When you hear "battery level low", you should recharge the NB05. Please plug it into a USB wall charger (DC 5V / 0.5-2A) or a powered USB port via the micro USB cable that we provided.

Normally it takes **3 hours** to fully recharge. LED indicator will show RED while charging and automatically turn off when the charging is complete.