

Roborock handheld cordless vacuum cleaner

instruction manual

roborock

Safety Information

IMPORTANT SAFETY INSTRUCTIONS

When using an electrical appliance, basic precautions should always be followed, including the following:

- READ ALL INSTRUCTIONS BEFORE USING (THIS APPLIANCE).
- Failure to follow the warnings and instructions may result in electric shock, fire and/or serious injury.

WARNING

To reduce the risk of fire, electric shock or injury:

- Do not use on wet surfaces. Do not expose to rain. Store indoors.
- Do not allow to be used as a toy. Close attention is necessary when used by or near children, pets or plants.
- Use only as described in this manual. Use only manufacturer's recommended attachments.
- Do not use with damaged cord or plug. If appliance is not working as it should, has been dropped, damaged, left outdoors, or dropped into water, return it to a service center.
- Do not pull or carry by cord, use cord as a handle, close a door on cord, or pull cord around sharp edges or corners. Do not run appliance over cord. Keep cord away from heated surfaces.
- Do not unplug by pulling on cord. To unplug, grasp the plug, not the cord.
- Do not handle Power Supply, including Power Supply plug, and Power Supply terminals with wet hands.
- Do not put any object into openings. Do not use with any opening blocked; keep free of dust, lint, hair, and anything that may reduce air flow.
- Keep hair, loose clothing, fingers, and all parts of body away from openings and moving parts.
- Use extra care when cleaning on stairs.
- Do not use to pick up flammable or combustible liquids, such as gasoline, or use in areas where they may be present.
- Do not pick up anything that is burning or smoking, such as cigarettes, matches, or hot ashes.
- Do not use without dust bag.
- Prevent unintentional starting. Ensure the switch is in the off-position before picking up or carrying the appliance. Carrying the appliance with your finger on the switch or energizing appliance that have the switch on invites accidents.
- Recharge only with the Power Supply specified by the manufacturer. A Power Supply that is suitable for one type of battery pack may create a risk of fire when used with another battery pack.
- Use appliances only with specifically designated battery packs. Use of any other battery packs may create a risk of injury and fire.

Safety Information

- When battery pack is not in use, keep it away from other metal objects, like paper clips, coins, keys, nails, screws or other small metal objects, that can make a connection from one terminal to another. Shorting the battery terminals together may cause burns or a fire.
- Under abusive conditions, liquid may be ejected from the battery; avoid contact. If contact accidentally occurs, flush with water. If liquid contacts eyes, additionally seek medical help. Liquid ejected from the battery may cause irritation or burns.
- Do not use a battery pack or appliance that is damaged or modified. Damaged or modified batteries may exhibit unpredictable behavior resulting in fire, explosion or risk of injury.
- Do not expose a battery pack or appliance to fire or excessive temperature. Exposure to fire or temperature above 130°C may cause explosion.
- Follow all charging instructions and do not charge the battery pack or appliance outside of the temperature range specified in the instructions. Charging improperly or at temperatures outside of the specified range may damage the battery and increase the risk of fire.
- Have servicing performed by a qualified repair person using only identical replacement parts. This will ensure that the safety of the product is maintained.
- Do not modify or attempt to repair the appliance or the battery pack except as indicated in the instructions for use and care.
- Always turn off this appliance before connecting or disconnecting motorized nozzle.

SAVE THESE INSTRUCTIONS

Household use only.

Safety Information

IMPORTANT SAFETY INSTRUCTIONS

L'utilisation d'un appareil électrique demande certaines précautions:

- LIRE TOUTES LES INSTRUCTIONS AVANT DE FAIRE FONCTIONNER (CET APPAREIL).
- Le non-respect des mises en garde et des instructions peut causer des chocs électriques, des incendies et/ou des blessures graves.

AVERTISSEMENT.

Pour réduire les risques d'incendie, de choc électrique ou de blessure:

- Ne pas aspirer des déchets humides. Ne pas exposer à la pluie. Ranger à l'intérieur.
- Ne pas permettre aux enfants de jouer avec l'appareil. Une attention particulière est nécessaire lorsque l'appareil est utilisé par des enfants ou à proximité de ces derniers.
- N'utiliser que conformément à cette notice avec les accessoires recommandés par le fabricant.
- Ne pas utiliser si le cordon ou la fiche est endommagé. Retourner l'appareil à un atelier de réparation s'il ne fonctionne pas bien, s'il est tombé ou s'il a été endommagé, oublié à l'extérieur ou immergé.
- Ne pas tirer soulever ni trainer l'appareil par le cordon. Ne pas utiliser le cordon comme une poignée, le coincer dans l'embrasure d'une porte ou l'appuyer contre des arêtes vives ou des coins. Ne pas faire rouler l'appareil sur le cordon. Garder le cordon à l'écart des surfaces chaudes.
- Ne pas débrancher en tyrant sur le cordon. Tirer plutôt la fiche.
- Ne pas manipuler le chargeur, y compris la prise du chargeur, et les bornes du chargeur avec les mains mouillées
- N'insérer aucun objet dans les ouvertures. Ne pas utiliser l'appareil lorsqu'une ouverture est bloquée. S'assurer que de la poussière, de la peluche, des cheveux ou d'autres matières ne réduisent pas le débit d'air.
- Maintenir les cheveux, les vêtements amples, les doigts et toutes les parties du corps à l'écart des ouvertures et des pièces mobiles.
- User de prudence lors du nettoyage des escaliers.
- Ne pas aspirer des liquides inflammables ou combustibles, comme de l'essence, et ne pas faire fonctionner dans des endroits où peuvent se trouver de tels liquides.
- Ne pas aspirer de matières en combustion ou qui dégagent de la fumée, comme des cigarettes, des allumettes ou des cendres chaudes.

Safety Information

- Ne pas utiliser l'appareil si le sac à poussière ou le filter n'est pas en place.
- Emêcher une mise en marche accidentelle. S'assurer que l'interrupteur est à la position arrêt avant de lever ou de déplacer l'appareil. Transporter l'appareil en gardant un doigt sur l'interrupteur, ou mettre sous tension un appareil dont l'interrupteur est à la position marche peut causer un accident.
- Recharger uniquement avec le chargeur prescrit par le fabricant. Un chargeur convenant à un type de batterie peut présenter un risque d'incendie lorsqu'il est utilisé avec une autre batterie.
- Utiliser uniquement les batteries recommandées pour l'appareil. L'utilisation d'autres types de batteries peut présenter un risque de blessure ou d'incendie.
- Lorsque l'appareil n'est pas utilisé, tenir la batterie loin d'objets métalliques comme des trombones, des pièces de monnaie, des clés, des clous, des vis ou autres petits objets qui pourraient établir une liaison entre les bornes. Un court-circuit des bornes des batteries peut causer des brûlures ou un incendie.
- En condition d'usage abusif, du liquide peut s'échapper de la batterie ; éviter tout contact avec ce liquide. En cas de contact accidentel, rincer abondamment avec de l'eau. En cas de contact avec les yeux, consulter également un médecin. Le liquide projeté peut causer des irritations ou des brûlures.
- Ne pas utiliser une batterie ou un appareil endommagé ou qui a été modifié. Des batteries endommagées ou modifiées peuvent avoir un comportement imprévisible pouvant causer un incendie, une explosion ou un risque de blessure.
- Ne pas exposer une batterie ou un appareil à la flamme ou à des températures excessives. L'exposition à une flamme ou à des températures supérieures à 130 °C peut causer une explosion.
- Respecter toutes les instructions de chargement et ne pas charger la batterie ou l'appareil à des températures qui ne sont pas incluses dans la gamme de températures indiquées dans la notice d'instructions. Un chargement mal effectué.
- Confier les réparations à une personne qualifiée qui utilisera uniquement des pièces de remplacement identiques. Cette façon de faire garantira la sécurité du produit.
- Ne pas modifier ni tenter de réparer l'appareil ou la batterie sauf comme il est indiqué dans les instructions d'utilisation et d'entretien.
- Toujours mettre l'interrupteur de l'appareil à la position ARRÊT avant de connecter ou d'enlever la brosse à moteur.

Safety Information

CONSERVER CES INSTRUCTIONS

Usage Domestique seulement

Battery and Charging

- Please keep the power supply and docking station away from heat (such as heating plates).
- For connection to a supply not in the U.S.A., use an attachment plug adapter of the proper configuration for the power outlet, if needed.
- The battery must be removed from the appliance before it is scrapped.
- The appliance must be disconnected from the supply mains when removing the battery.
- The battery is to be disposed of safely. Please do not discard waste batteries. Leave them to a professional recycling organization.
- Do not wipe or clean the power supply or docking station shrapnel with a piece of wet cloth or wet hands.
- Please make sure the cleaner is powered off in shipment and original packaging is advised.
- If left unused for a long period, please store the cleaner in a cool and dry place after having it fully charged and switched off, charge it at least every three months to avoid the battery being over discharged.
- Please do not use the product when the temperature is higher than 40°C or lower than 4°C , or there is any liquid or sticky substance on the floor.

Battery pack charging temperature		4°C ~ 40°C
Battery pack using temperature		4°C ~ 40°C
Battery pack storage temperature	Storage(within 3 months)	-20°C ~ 45°C @Less than 75% RH
	Long Storage(3months)	25+/- 3°C @Less than 75% RH

Batterie et chargement

- Conservez l'alimentation électrique et la station de chargement à l'écart de toutes sources de chaleur (des plaques chauffantes, par exemple).
- Pour un branchement à une alimentation à l'extérieur des États-Unis, utilisez un adaptateur de fiche de branchement d'une configuration adéquate à la prise d'alimentation.
- La batterie doit être retirée de l'appareil avant d'être mise au rebut.
- Lorsqu'on retire la batterie, l'appareil doit avoir été débranché de toute alimentation électrique.
- La batterie doit être mise au rebut de manière sécurisée. Ne mettez pas au rebut les batteries usagées. Confiez-les à un organisme professionnel de recyclage.
- N'essayez pas et ne nettoyez pas le chargeur ou la station de chargement avec un tissu humide ou avec les mains mouillées.
- Si vous renvoyez l'aspirateur, assurez-vous que celui-ci est bien éteint et, de préférence, retournez-le dans son emballage d'origine.
- Si l'appareil doit rester inutilisé pendant une période prolongée, rangez-le dans un endroit frais et sec après l'avoir totalement chargé et éteint. Chargez-le au moins tous les trois mois pour éviter que la batterie ne se décharge complètement.
- N'utilisez pas le produit lorsqu'il fait plus de 40 °C ou moins de 4 °C, ou lorsqu'il y a du liquide ou une substance collante sur le sol.

Température de chargement du bloc de batterie		4 °C ~ 40 °C
Température d'utilisation du bloc de batterie		4 °C ~ 40 °C
Température de stockage du bloc de batterie	Stockage (dans les 3 mois)	-20 °C ~ 45 °C À moins de 75 % d'humidité relative
	Stockage pour une longue période (3 mois)	25+/-3 °C À moins de 75 % d'humidité relative

International symbols explanation

- Ⓞ - ON-OFF (push-push) symbol [symbol IEC 60417-5010 (2009-02)]
- ~ - ALTERNATING CURRENT symbol [symbol IEC 60417-5032 (2009-02)]
- = - DIRECT CURRENT symbol [symbol IEC 60417-5031 (2009-02)]

FCC Statement

Compliance Information	
Product Name	Handheld Vacuum Cleaner with Power Supplyr
Produce Model	Handheld Vacuum Cleaner Model: H6M1A Power Supply Model: BTC03RR
Compliance Statement	This device complies with part 15 of the FCC Rules. Operation is subject to the following two conditions: (1) This device may not cause harmful interference, and (2) this device must accept any interference received, including interference that may cause undesired operation.
Correspondence of the responsible party in USA	
Company	Roborock Technology Co.
Address	108 West 13th Street, Wilmington, Delaware 19801.
Email	support@roborock.com

FCC Statement

Warning

Any changes or modifications to this unit not expressly approved by the party responsible for compliance could void the user's authority to operate the equipment.

Note: This equipment has been tested and found to comply with the limits for a Class B digital device, pursuant to part 15 of the FCC Rules. These limits are designed to provide reasonable protection against harmful interference in a residential installation. This equipment generates, uses and can radiate radio frequency energy and, if not installed and used in accordance with the instructions, may cause harmful interference to radio communications. However, there is no guarantee that interference will not occur in a particular installation. If this equipment does cause harmful interference to radio or television reception, which can be determined by turning the equipment off and on, the user is encouraged to try to correct the interference by one or more of the following measures:

- Reorient or relocate the receiving antenna.
- Increase the separation between the equipment and receiver.
- Connect the equipment into an outlet on a circuit different from that to which the receiver is connected.
- Consult the dealer or an experienced radio/TV technician for help.

IC Statement

This device contains licence-exempt transmitter(s)/receiver(s) that comply with innovation, Science and Economic Development Canada's licence-exempt RSS(s). Operation is subject to the following two conditions:

(1) This device may not cause interference, and (2) This device must accept any interference, including interference that may cause undesired operation of the device.

L'émetteur/récepteur exempt de licence contenu dans le présent appareil est conforme aux CNR d'Innovation, Sciences et Développement économique Canada applicables aux appareils radio exempts de licence. L'exploitation est autorisée aux deux conditions suivantes :

(1) L'appareil ne doit pas produire de brouillage;

(2) L'appareil doit accepter tout brouillage radioélectrique subi, même si le brouillage est susceptible d'en compromettre le fonctionnement.

CAN ICES-3 (B)/NMB-3(B)

Product introduction

Vacuum

Rear Filter

Screen

Mode Button

- Press the Mode button to change vacuum mode

* In MAX mode, the fan will run at full speed. Battery life will shorten and hot air may be emitted.

Sustain Button

- Squeeze the Trigger to start vacuuming. Press the Sustain button with the Trigger squeezed to enter Sustain mode.

* Pressing the Sustain button for 2 seconds in any mode will stop the vacuum.

Trigger

- Squeeze to turn on
- Release to turn off.

Charging Port

Emptying Latch

- Press the Emptying Latch down to empty the dustbin. The dustbin should be emptied after each use.

Dustbin

Dustbin Removal Latch

Charging Contacts

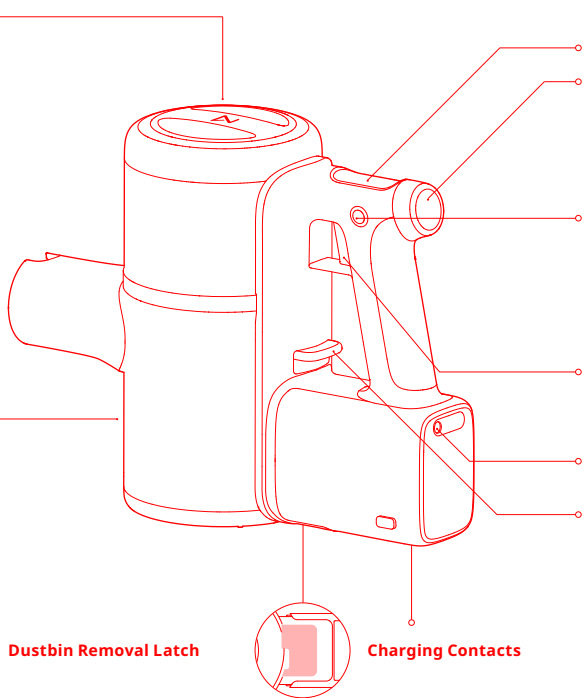

Parts List

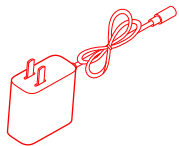

Power Supply



Crevice Tool



Dusting Brush

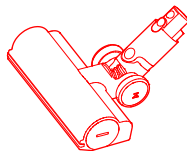

Carpet Brush

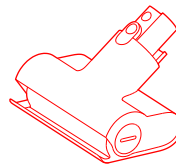

Motorized Mini-Brush



Baton



Flex Tube

Screen display

This Roborock cordless vacuum is equipped with a 1.3-inch OLED display that shows relevant information in real-time.

Standby and operating modes

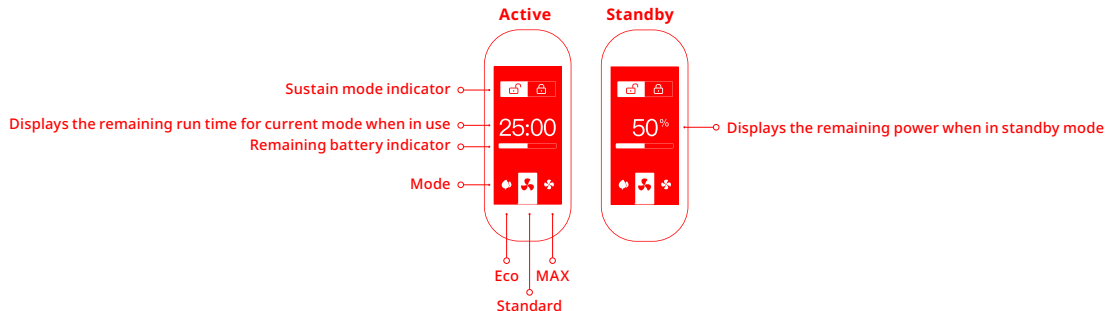

Notes:

1. The run time indicator will appear after several seconds of use.
2. Remaining run time is for reference only and may be different to actual run time.

Charging

When the battery is charging, a charging animation will show alongside the current battery level. The screen will turn off automatically after 1 minute of inactivity.

Error

If an error occurs while the vacuum is in operation, the screen will show an error message. See Troubleshooting for details.

Buttons

Sustain Button

Press the Sustain button to enter Sustain mode. The Sustain icon will appear on screen. Squeeze the trigger while in Sustain mode to start the vacuum and enable it to run continuously. In Sustain mode, the vacuum will not stop when the trigger is released. Press the Sustain button again to disengage Sustain mode and stop vacuuming.

You can also enable the vacuum to run continuously by first pressing the trigger then pressing the Sustain button.

Notes:

1. Squeezing the trigger while the vacuum is already running continuously in Sustain mode will have no effect.
2. Pressing the Sustain button for 2 seconds in any active mode will stop the vacuum.

Trigger

Squeeze the trigger to start vacuuming.

* Press the Sustain button while the vacuum is running continuously to disengage Sustain mode.

Releasing the trigger will stop the vacuum and enter it into Standby mode, unless it is in Sustain mode. The screen will turn off automatically after 30 seconds of inactivity and the vacuum will automatically turn off after 1 minute of inactivity.

Notes:

1. The vacuum will stop running when charging.
2. Insufficient power or other errors may cause the vacuum to fail. See Troubleshooting for details.

Mode Switch button

When the vacuum is on, press the Mode button to switch between Eco, Standard, or MAX modes. The respective icon will be highlighted on-screen.

Note:

The vacuum will return to Standard mode after turning off or when charging.

Installation

Vacuum and accessories setup

Option 1 Connect the Baton to the vacuum, then attach an accessory.

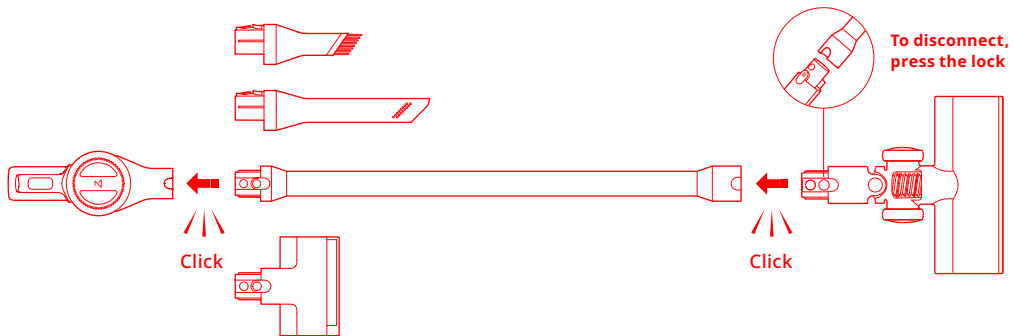

Option 2 Connect the vacuum directly to an accessory

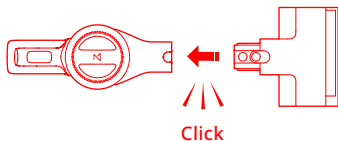

Option 3 Connect the flex tube to the vacuum, then attach an accessory.

* Motorized accessories such as the motorized mini-brush or Carpet brush cannot be used with the flex tube.

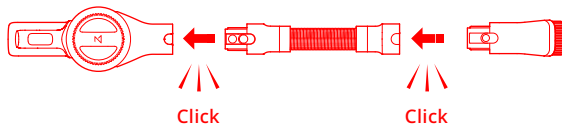

Use

Charging

When the battery is charging, a charging animation will show alongside the current battery level.

The screen will turn off automatically after 1 minute of inactivity.

Notes:

1. When charging, the screen image faces the user for easy viewing.
2. When charging, the vacuum will enter Charging mode and stop all other functions.
3. The battery temperature will increase after continuous use in MAX mode. As a result, recharging may take longer.
4. When battery levels are very low, the vacuum screen will only light up after a period of charging.

Before using the vacuum, read the " Safety Instructions" in this user manual

Note:

Make sure the Power Supply is firmly inserted into the power socket.

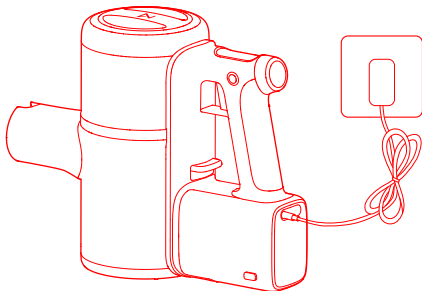

Charge with the Power Supply

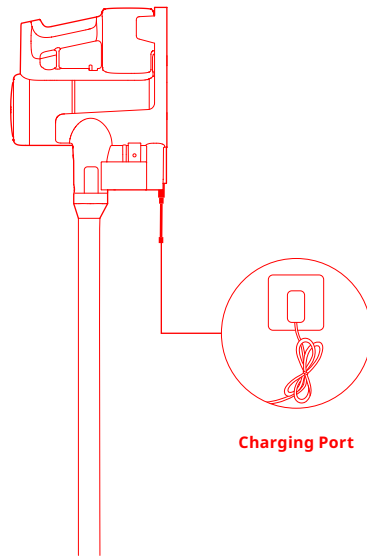

Charging Port

Charge with the charging stand

Use

Using the vacuum

1. When using the Carpet brush or motorized mini-brush on the vacuum cleaner, the surfaces of some fabrics may pill or be difficult to vacuum. If this occurs, it is recommended that you use the dusting brush or crevice tool to vacuum these surfaces.
2. Before vacuuming shiny floors such as parquet or tiles, ensure there is no hard debris trapped the Carpet Brush to avoid scratches.
3. Before using the vacuum, ensure that the Dustbin, Multi-Cyclone Assembly, and filters have been properly installed.
4. Do not block the exhaust outlet when vacuuming.
5. This vacuum is designed for domestic use. Flour and other fine dust should only be vacuumed in small amounts.
6. To avoid damage to the vacuum or the floor, do not use the vacuum to clean up hard or sharp objects such as toys and nails.
7. Be aware of your environment as you vacuum, especially around stairs and windows.
8. To avoid accidental fall damage, avoid placing the vacuum on raised surfaces such as desks and shelves, or leaning it against other objects.
9. The rotation of the Carpet Brush may leave an unevenly polished floor. This can be resolved by wiping with a damp cloth or polishing with floor wax.

Auto Shutoff

1. If any rotating parts get jammed, the vacuum will shut off automatically. Clear the jam to continue vacuuming.
2. If the motor gets too hot, the vacuum will automatically shut off. Wait until the temperature returns to normal before continuing.

Keep the Brush Clear

1. Electric brushes will automatically stop if jammed by dirt or long fibers during use. If this occurs, clear them before continuing.
2. Detach the brush from the vacuum before cleaning. Avoid turning the vacuum on when no brush is attached.

Precautions:

1. Beware of sharp objects trapped in the roller.
2. If debris trapped in the roller cannot be easily extracted, see the "Clean Roller" section for details on removing the roller.

Use

Brush Accessory Uses

1. Crevice Tool:

Narrow crevices, including skirting boards, corners, and stairs.

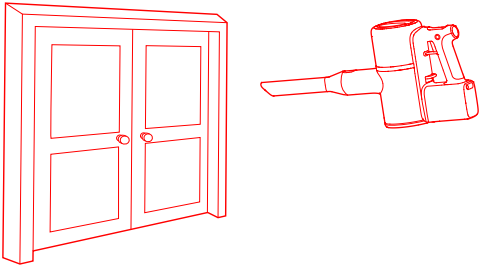

2. Dusting Brush:

Dusting sofas, chairs, and other soft furnishings, and flat surfaces such as desks and shelves.



Tip:

The Dusting Brush can also be used on its own to dust the vacuum and other items around the house.

3. Motorized Mini-Brush:

Cleaning dust from beds, sofas, and soft furnishings to avoid mites.

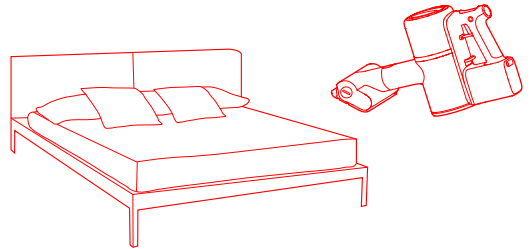

Use

Brush Accessory Uses

4. Carpet Brush:

Connect to the Baton for cleaning short and medium-pile carpets. Carpet Brush can also be used on easily scratched floor surfaces.

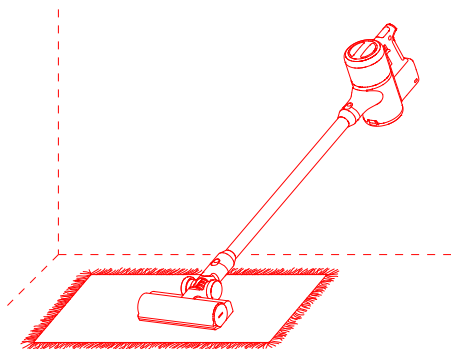

Carpet Boost is automatically activated when the Carpet Brush is installed. When a carpet is detected, suction automatically increases to MAX for a deeper clean. It will return to the previous mode when carpet is no longer detected.

Notes:

1. Carpet Boost will not activate when vacuuming in MAX mode.
2. Use the Carpet Brush for easily scratched floor surfaces.

5. Flex Tube:

Connect to Dusting Brush or Crevice Tool to clean small or narrow spaces such as drawers and car interiors.

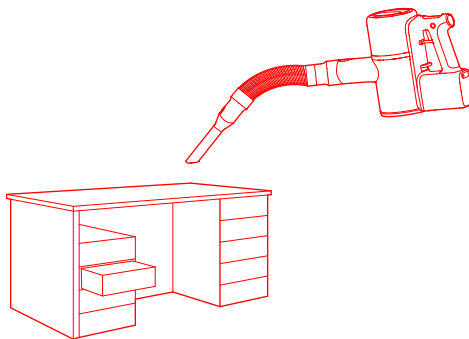

Maintenance

Product Warranty

1. Only use original parts. The use of non-original parts may affect your eligibility for warranty services.
2. If the filter or accessory is jammed, the vacuum will start and stop several times before shutting off. Clean the filters and the accessory before further use.
3. If the vacuum is to be left unused for an extended period, fully charge it and shut it down before storing it in a cool and dry place. Do not place the vacuum in humid locations or in direct sunlight. Charge the vacuum at least once every 3 months to prevent damage to the battery.

Cleaning the vacuum

Use a soft dry cloth to wipe the vacuum.

Emptying the dustbin

1. When the dustbin is full, suction will be reduced. Empty it before continuing with vacuuming. Before cleaning the dustbin, disconnect the vacuum from mains power and keep it switched off.

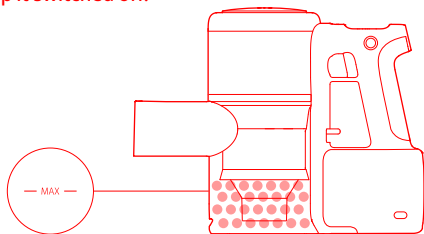

2. To empty the dustbin, push the Dustbin Opener on the front of the handle in the direction of the arrow to open it, then empty it into a bin. The dustbin should be emptied at least once a week.

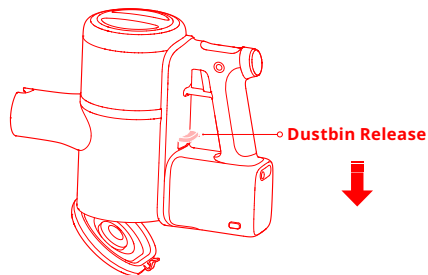

Maintenance

Cleaning the dustbin

3. Push the Dustbin Removal Latch next to the dustbin after emptying it to remove the dustbin for cleaning.

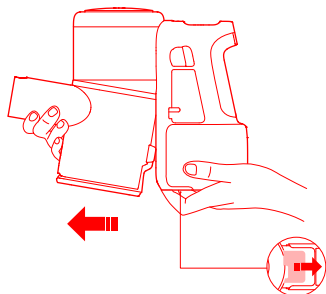

Dustbin Removal Latch

4. The dustbin should be rinsed with water at least once a month. Charging contacts should also be wiped with a soft, dry cloth once a month.

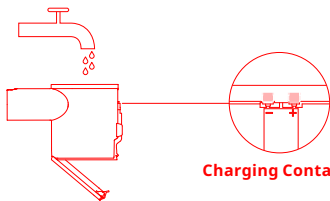

Charging Contacts

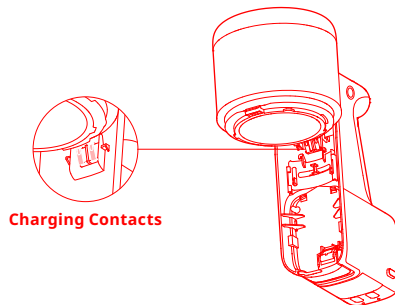

Charging Contacts

Note:

Do not clean the dustbin with detergents, polishes, or air fresheners.
Do not put the dustbin in a dishwasher or any similar appliance.

5. When the dustbin is thoroughly dry, re-install it as shown.

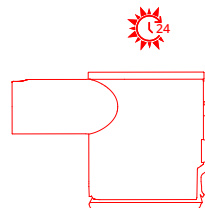

Maintenance

Dustbin Installation

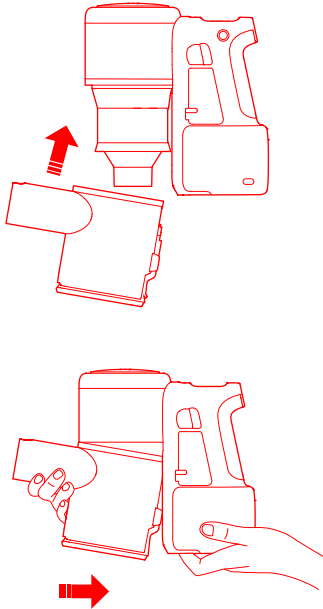

Cleaning the Front Filter and Multi-Cyclone Assembly

- * Front Filter and Multi-Cyclone Assembly should be cleaned at least once a month
1. Disconnect the vacuum from power before cleaning it, and avoid squeezing the Power Trigger during cleaning.
 2. Inspect and clean the Front Filter according to the manual regularly to ensure optimum vacuum performance.
 3. If cleaning fine dust or operating in MAX mode, the Front Filter may require more frequent washing.

1. Remove the Dustbin as shown.

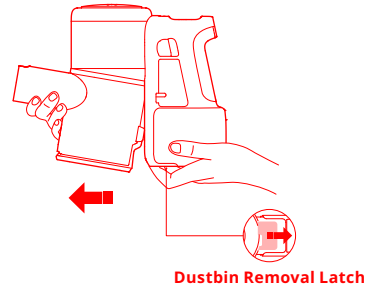

Maintenance

Removing the Front Filter and Multi-Cyclone Assembly

2. Rotate Multi-Cyclone Assembly counterclockwise as shown.

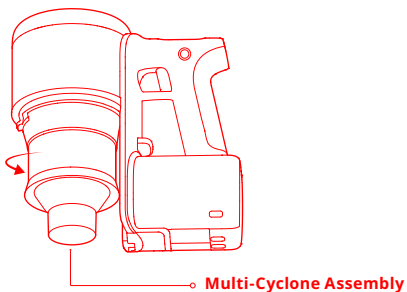

3. Remove the Front Filter.

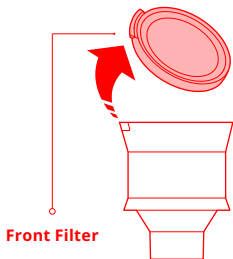

4. Rinse the Front Filter and Multi-Cyclone Assembly with cold water until clean, then allow to dry.

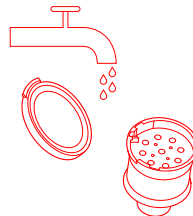

5. Leave 24 hours for the Front Filter and Multi-Cyclone Assembly to dry thoroughly.

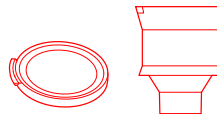

Caution:

Do not clean the filter in a dishwasher, washing machine, tumble dryer, oven, microwave, with hot air, or near a fire.

6. After drying, re-assemble the Front Filter and Multi-Cyclone Assembly.

Maintenance

Front Filter and Multi-Cyclone Assembly Installation

1. Position the Front Filter, as shown.

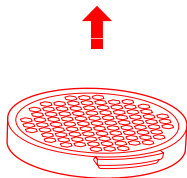

2. Place the Front Filter from the right side of the multi-cyclone assembly and lightly push it to the left to disengage the “No Filter Protection Lock”. Once the lock is nested into its slot, press down on the filter to secure it in place.

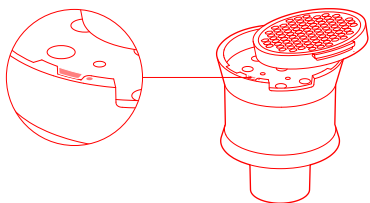

3. Align the Multi-Cyclone Array and the vacuum as shown then turn them clockwise to lock them in place.

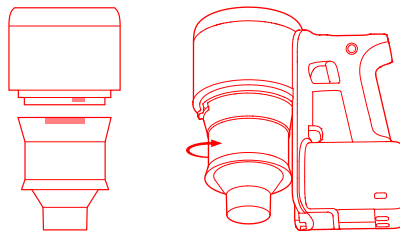

4. Tilt the dustbin and slot it back onto the vacuum.

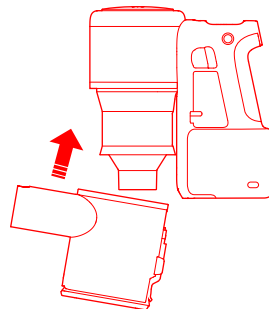

Maintenance

Front Filter and Multi-Cyclone Assembly Installation

5. Gently push the dustbin in the direction shown until you hear a click signaling that it is secured.

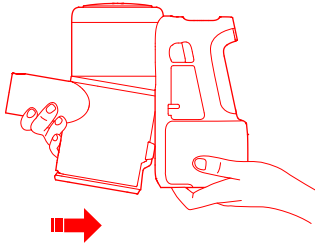

Cleaning Rear Filter

1. Remove the Rear Filter by turning it counterclockwise then pulling it off.

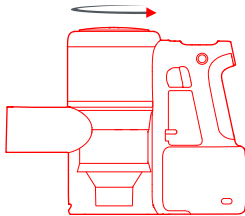

2. Rinse the inside of the Rear Filter with water, rotating it while rinsing to clean between all gaps. Lightly tap the filter against the sink after rinsing to dislodge any remaining dirty water.

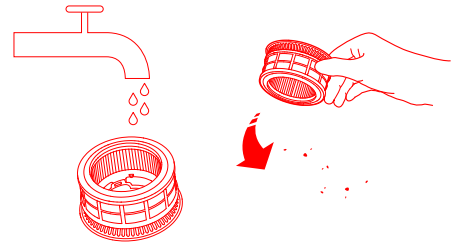

4. Allow 24 hours for the filter to dry thoroughly.



Maintenance

Cleaning Rear Filter

* Washing the Rear Filter every two months is recommended

5. When dry, reinstall the filter by aligning it with the unlock mark, slotting it into the vacuum, then turning clockwise to lock it in place.

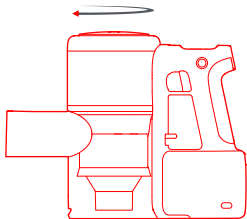

Cleaning the Rollers

Follow these instructions when inspecting and cleaning the Rollers to ensure optimum performance. Inspection and cleaning should be performed regularly. Before removing the roller, remove the accessory from the vacuum to avoid accidental damage.

Note:

Motorized Mini-Brush and Carpet brush rollers must be removed and cleaned separately. As there are electrical components and bearings in these rollers, do not wash them with water.

Maintenance

Cleaning the Motorized Mini-Brush

1. Hold the brush so that the locking mechanism faces you. Use a coin to turn the lock counterclockwise and remove the mechanism.

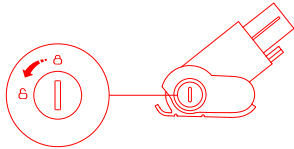

2. After removing the locking mechanism, remove the roller.

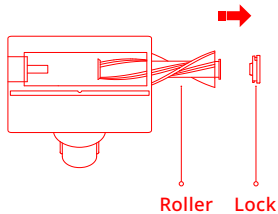

3. Clean and wash the roller

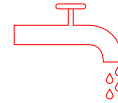

4. Place the roller vertically and leave it to dry for at least 24 hours.



Maintenance

Cleaning the Motorized Mini-Brush

5. When the roller is thoroughly dry, reinstall it.

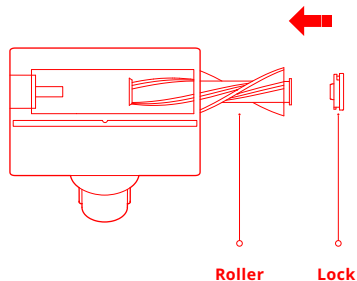

6. Hold the brush, so the locking mechanism faces you. Place the roller in position then use a coin to turn the lock counterclockwise to lock it in place.

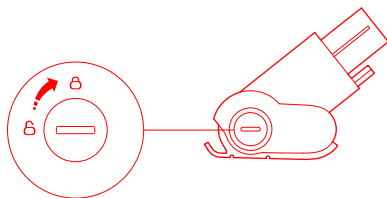

Cleaning the Carpet Brush

1. Hold the brush so that the locking mechanism faces you. Use a coin to turn the lock counterclockwise and remove the mechanism.



2. After removing the locking mechanism, remove the roller.

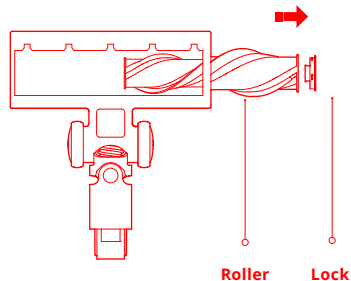

Maintenance

Cleaning the Carpet Brush

3. Take the End Cap off the roller and remove any fibers wrapped around either part.

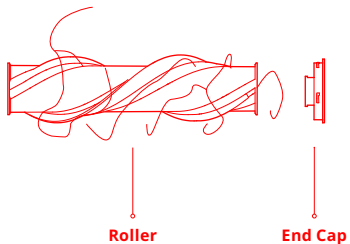

4. After cleaning, reinstall the end cap.



5. Reinstall the roller, as shown.

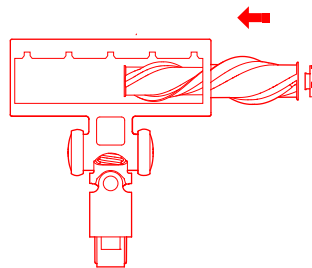

6. Hold the brush, so the locking mechanism faces you. Place the roller in position then use a coin to turn the lock counterclockwise and lock it in place.



Basic parameters

Vacuum

Name	Parameters
Model	H6M1A
Dimensions	284mm x 111mm x 221mm
Battery	22.2V/3610mAh(TYP) Lithium battery
Weight	Approx. 1.4kg
Rated Voltage	22.2V ---
Rated Power	420W



Power Supply

Name	Parameters
Model	BTC03RR
Dimensions	65.2mm x 36.3mm x 83.1mm
Rated Input	100-240V ~ 0.6A
Rated Output	25.6V --- 0.8A
Rated Frequency	50-60Hz

Troubleshooting

Error messages displayed onscreen

If the vacuum is not operating properly, the screen will display an error message. Check the screen and then read the table below to resolve any issues.

Error Severity	Screen	Solution
	Low battery. Recharge before use.	Low battery. Recharge before use.
	Abnormal temperature. Wait for normal battery temp.	Place vacuum in a cool place. Wait for normal battery temp.
	Abnormal temperature. Wait for normal battery temp. before recharging.	Disconnect vacuum from power and place it in a cool place. Wait for normal battery temp. before recharging.
	Check accessory. The accessory may be jammed.	Check if the accessory is jammed. See Maintenance and Warranty for details.
	Airflow blocked. The accessory or the filters may be clogged.	Check for blockages in the accessory or the filters, and empty the dustbin if it is full.
	Internal error. Contact customer support. Error code 0X	Contact customer support and provide the error code
	Charging error. Contact customer support. Error Code 0X	
	Fan error. Contact customer support. Error code 0X	

Other errors

Error	Solution
The Screen is not switching on	<ol style="list-style-type: none">1. Possible insufficient power. Try again after recharging. If the product is to be left unused for a prolonged period of time, fully charge it before storing it and charge to full at least every 3 months.2. If the screen does not turn on after charging, contact customer support.
Electric brush not rotating	<ol style="list-style-type: none">1. The brush motor may have overheated. Let it cool before use.2. The electric brush contact point may be dirty. Wipe it with a soft, dry cloth and retry.
Carpet Boost switches activates on hard floors	Debris may be trapped in the brush. Clear it and check that it can rotate smoothly then try again.
Suction is weak	<ol style="list-style-type: none">1. The Dustbin is full, and/or the filters are blocked. Empty the Dustbin and clean the filters then retry.2. The accessory may be clogged. Clean the accessory, removing any obstructions, then retry.

Roborock handheld cordless vacuum cleaner

Manufacturer: Beijing Roborock Technology Co., Ltd.

Product Model: H6M1A

Address of Manufacturer: Floor 6, Suite 6016, 6017, 6018, Building C, Kangjian Baosheng Plaza,
No.8 Heiquan Road, Haidian District, Beijing, P.R.CHINA

For more product information, visit our website: www.roborock.com

For after-sales support, email our after-sales service team:

US/Non-Europe Support: support@roborock.com

Europe Support: support@roborock-eu.com

