

# EMC TEST REPORT

**Application No.** : HX221102095688

**Applicant** : QUANZHOU ZHENGSHENG CRAFTS CO., LTD.

**Equipment Under Test (EUT)**

**EUT Name** : Solar cell box

**Model No.** : ZS202211DCDL

**Serial No.** : N/A

**Trademark** : N/A

**Receipt Date** : 2022-11-21

**Test Date** : 2022-11-21 to 2022-11-25

**Issue Date** : 2022-11-25

**Standards** : EN IEC 55015: 2019/A11: 2020;  
EN 61547: 2009.

**Conclusions** : **PASS**

In the configuration tested, the EUT complied with the standards specified above. The EUT technically complies with the 2014/30/EU directive requirements.

**Test/Witness Engineer** : *Tim Chen*

**Approved & Authorized** : *Andy Zhang*



This report details the results of the testing carried out on one sample. The results contained in this test report do not relate to other samples of the same product. The manufacturer should ensure that all products in series production are in conformity with the product sample detailed in the report.

---

---

## TABLE OF CONTENTS

<b>1.</b>	<b>GENERAL INFORMATION</b> .....	<b>3</b>
1.1.	Client Information .....	3
1.2.	General Description of EUT (Equipment Under Test).....	3
1.3.	Block Diagram Showing the Configuration of System Tested .....	3
1.4.	Description of Support Units .....	3
1.5.	Performance Criterion .....	3
1.6.	Test Facility .....	4
<b>2.</b>	<b>TEST RESULTS SUMMARY</b> .....	<b>5</b>
<b>3.</b>	<b>TEST EQUIPMENT USED</b> .....	<b>6</b>
<b>4.</b>	<b>CONDUCTED EMISSION TEST</b> .....	<b>8</b>
4.1.	Test Standard and Limit .....	8
4.2.	Test Setup .....	8
4.3.	Test Procedure .....	8
4.4.	Test Condition .....	9
4.5.	Test Data .....	9
<b>5.</b>	<b>MAGNETIC FIELD EMISSION MEASUREMENT</b> .....	<b>10</b>
5.1.	Test Standard and Limit .....	10
5.2.	Test Setup .....	10
5.3.	Test Procedure .....	10
5.4.	Test Condition .....	11
5.5.	Test Data .....	11
<b>6.</b>	<b>RADIATED DISTURBANCE TEST</b> .....	<b>15</b>
6.1.	Test Standard and Limit .....	15
6.2.	Test Setup .....	15
6.3.	Test Procedure .....	15
6.4.	Test Condition .....	16
6.5.	Test Data .....	16
<b>7.</b>	<b>ELECTROSTATIC DISCHARGE IMMUNITY TEST</b> .....	<b>19</b>
7.1.	Test Requirements .....	19
7.2.	Test Setup .....	19
7.3.	Test Procedure .....	19
7.4.	Test Data .....	20
<b>8.</b>	<b>RADIATED ELECTROMAGNETIC FIELD IMMUNITY TEST</b> .....	<b>22</b>
8.1.	Test Requirements .....	22
8.2.	Test Setup .....	22
8.3.	Test Procedure .....	22
8.4.	Test Data .....	23
<b>9.</b>	<b>PHOTOGRAPHS - CONSTRUCTIONAL DETAILS</b> .....	<b>25</b>

# 1. General Information

## 1.1. Client Information

Applicant	:	QUANZHOU ZHENGSHEG CRAFTS CO., LTD.
Address	:	5F, No. 43, Zishan Road, Xiadian Community, Changtai Street, Licheng District, Quanzhou City, Fujian Province, China
Manufacturer	:	QUANZHOU ZHENGSHEG CRAFTS CO., LTD.
Address	:	5F, No. 43, Zishan Road, Xiadian Community, Changtai Street, Licheng District, Quanzhou City, Fujian Province, China

## 1.2. General Description of EUT (Equipment Under Test)

EUT Name	:	Solar cell box
Model No.	:	ZS202211DCDL
Serial No.	:	N/A
Trademark	:	N/A
Power Supply	:	DC 2V, 195mA

## 1.3. Block Diagram Showing the Configuration of System Tested



## 1.4. Description of Support Units

The EUT has been tested as an independent unit.

## 1.5. Performance Criterion

**Criterion A:** The equipment shall continue to operate as intended without operator intervention. No degradation of performance or loss of function is allowed below a performance level specified by the manufacturer when the equipment is used as intended.

**Criterion B:** After the test, the equipment shall continue to operate as intended without operator intervention. No degradation of performance or loss of function is allowed, after the application of the phenomena below a performance level specified by the manufacturer, when the equipment is used as intended.

**Criterion C:** Loss of function is allowed, provided the function is self-recoverable, or can be restored by the operation of the controls by the user in accordance with the manufacturer's instructions.

## 1.6. Test Facility

The testing report were performed by the Shenzhen HX Detect Certification Co., Ltd., in their facilities located at 101, building B12, Yintian Industrial Zone, Yantian community, Xixiang street, Bao'an District, Shenzhen.

DRAFT



## 2. Test Results Summary

EMISSION (EN IEC 55015:2019/A11:2020)		
Description of test item	Standards	Results
Conducted Disturbance at Mains Terminals	EN IEC 55015: 2019/A11: 2020	Pass
Magnetic Emission	EN IEC 55015: 2019/A11: 2020	Pass
Radiated Disturbance	EN IEC 55015: 2019/A11: 2020	Pass
Harmonic Current Emissions	EN IEC 61000-3-2: 2019/A1: 2021	N/A
Voltage Fluctuation and Flicker	EN 61000-3-3:2013/A1:2019	N/A
IMMUNITY (EN 61547: 2009)		
Description of Test Item	Basic Standards	Results
Electrostatic Discharge (ESD)	EN 61000-4-2: 2009	Pass
Radio-frequency, Continuous Radiated Disturbance	EN IEC 61000-4-3: 2020	Pass
EFT/B Immunity	EN 61000-4-4: 2012	N/A
Surge Immunity	EN 61000-4-5: 2014/A1:2017	N/A
Conducted RF Immunity	EN 61000-4-6: 2014	N/A
Power Frequency Magnetic Field	EN 61000-4-8: 2010	N/A
Voltage Dips and Interruptions, 100% Reduction	EN IEC 61000-4-11:2020	N/A
Voltage Dips and Interruptions, 30% reduction		N/A

### 3. Test Equipment Used

3.1. Test Equipment Used to Measure Conducted Emission					
No.	Equipment	Manufacturer	Model No.	Last Cal.	Cal. Interval
HX-EMC001	EMI Test Receiver	Rohde & Schwarz	ESCS30	Dec. 30, 2021	1 Year
HX-EMC002	AMN	Rohde & Schwarz	ENV216	Dec. 30, 2021	1 Year
HX-EMC003	AMN	SCHWARZBECK	NNBL 8226-2	Dec. 30, 2021	1 Year
3.2. Test Equipment Used to Measure Magnetic Field Emission					
No.	Equipment	Manufacturer	Model No.	Last Cal.	Cal. Interval
HX-EMC001	EMI Test Receiver	Rohde & Schwarz	ESCS30	Dec. 30, 2021	1 Year
HX-EMC027	Triple-Loop Antenna	EVERFINE	LLA-2	Dec. 30, 2021	1 Year
3.3. Test Equipment Used to Measure Radiated Emission					
No.	Equipment	Manufacturer	Model No.	Last Cal.	Cal. Interval
HX-EMC004	EMI Test Receiver	Rohde & Schwarz	ESL26	Dec. 30, 2021	1 Year
HX-EMC005	Bilog Antenna	SCHWARZBECK	VULB9163	Dec. 30, 2021	1 Year
HX-EMC006	Positioning Controller	C&C	CC-C-1F	N/A	N/A
3.4. Test Equipment Used to Measure Harmonic Current/ Voltage Fluctuation and Flicker					
No.	Equipment	Manufacturer	Model No.	Last Cal.	Cal. Interval
HX-EMC007	Harmonic Flicker Test System	CI	5001ix-CTS-400	Dec. 30, 2021	1 Year
3.5. Test Equipment Used to Measure Electrostatic Discharge Immunity					
No.	Equipment	Manufacturer	Model No.	Last Cal.	Cal. Interval
HX-EMC008	ESD Tester	TESEQ	NSG437	Dec. 30, 2021	1 Year
3.6. Test Equipment Used to Measure Conducted Immunity					
No.	Equipment	Manufacturer	Model No.	Last Cal.	Cal. Interval
HX-EMC009	RF Generator	FRANKONIA	CIT-10/75	Dec. 30, 2021	1 Year
HX-EMC010	Attenuator	FRANKONIA	59-6-33	Dec. 30, 2021	1 Year
HX-EMC011	M-CDN	LUTHI	M2/M3	Dec. 30, 2021	1 Year
HX-EMC012	CDN	LUTHI	AF2	Dec. 30, 2021	1 Year

HX-EMC013	EM Injection Clamp	LUTHI	EM101	Dec. 30, 2021	1 Year
<b>3.7. Test Equipment Used to Measure Radio Frequency Electromagnetic Fields Immunity</b>					
No.	Equipment	Manufacturer	Model No.	Last Cal.	Cal. Interval
HX-EMC014	Signal Generator	Rohde & Schwarz	SMT03	Dec. 30, 2021	1 Year
HX-EMC015	Power Meter	Rohde & Schwarz	NRVD	Dec. 30, 2021	1 Year
HX-EMC016	Voltage Probe	Rohde & Schwarz	URV5-Z2	Dec. 30, 2021	1 Year
HX-EMC017	Voltage Probe	Rohde & Schwarz	URV5-Z2	Dec. 30, 2021	1 Year
HX-EMC018	Power Amplifier	AR	150W1000	Dec. 30, 2021	1 Year
HX-EMC019	Bilog Antenna	Chase	CBL6111C	Dec. 30, 2021	1 Year
<b>3.8. Test Equipment Used to Measure Electrical Fast Transient/Burst Immunity</b>					
No.	Equipment	Manufacturer	Model No.	Last Cal.	Cal. Interval
HX-EMC020	Simulator	EMTEST	UCS500N5	Dec. 30, 2021	1 Year
HX-EMC021	Auto-transformer	EMTEST	V4780S2	Dec. 30, 2021	1 Year
<b>3.9. Test Equipment Used to Measure Surge Immunity</b>					
No.	Equipment	Manufacturer	Model No.	Last Cal.	Cal. Interval
HX-EMC022	Simulator	EMTEST	UCS500N5	Dec. 30, 2021	1 Year
HX-EMC023	Coupling Clamp	EMTEST	HFK	Dec. 30, 2021	1 Year
<b>3.10. Test Equipment Used to Measure Voltage Dips and Interruptions Immunity</b>					
No.	Equipment	Manufacturer	Model No.	Last Cal.	Cal. Interval
HX-EMC022	Simulator	EMTEST	UCS500N5	Dec. 30, 2021	1 Year
HX-EMC023	Coupling Clamp	EMTEST	HFK	Dec. 30, 2021	1 Year
<b>3.11. Test Equipment Used to Measure Power frequency Magnetic Field</b>					
No.	Equipment	Manufacturer	Model No.	Last Cal.	Cal. Interval
HX-EMC026	Power Frequency Magnetic Field Generator	EVERFINE	EMS61000-8K	Dec. 30, 2021	1 Year

## 4. Conducted Emission Test

### 4.1. Test Standard and Limit

#### 4.1.1. Test Standard

EN IEC 55015: 2019/A11: 2020.

#### 4.1.2. Test Limit

Conducted Disturbance Test Limit (Class B)

Frequency	Maximum RF Line Voltage (dB $\mu$ V)	
	Quasi-peak Level	Average Level
9kHz~50kHz	110	--
50kHz ~150kHz	90 to 80*	--
150kHz~500kHz	66 ~ 56 *	56 ~ 46 *
500kHz~5MHz	56	46
5MHz~30MHz	60	50

**Remark:** 1. \*Decreasing linearly with logarithm of the frequency  
 2. At the transition frequency, the lower limit applies.  
 3. For electrodeless lamps and luminaries, the limit in the frequency range of 2,51 MHz to 3,0 MHz is 73 dB( $\mu$ V) quasi-peak and 63 dB( $\mu$ V) average

### 4.2. Test Setup

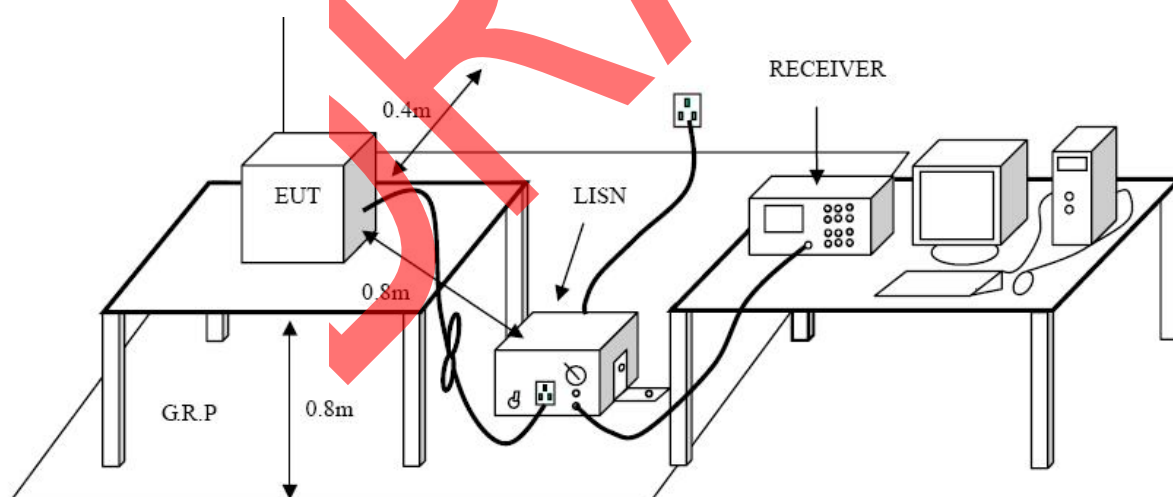

### 4.3. Test Procedure

The EUT was placed 0.4 meters from the horizontal ground plane with EUT being connected to the power mains through a line impedance stabilization network (LISN). All other support equipments powered from additional LISN(s). The LISN provide 50 Ohm/ 50uH of coupling impedance for the measuring instrument.

Interconnecting cables that hang closer than 40 cm to the ground plane shall be folded back and forth in the center forming a bundle 30 to 40 cm long.

I/O cables that are not connected to a peripheral shall be bundled in the center. The end of the cable may be terminated, if required, using the correct terminating impedance. The overall length shall not exceed 1 m.

LISN at least 80 cm from nearest part of EUT chassis.

The bandwidth of EMI test receiver is set at 9kHz, and the test frequency band is from 9KHz to 30MHz.

#### 4.4. Test Condition

Temperature	:	25 °C
Relative Humidity	:	48 %
Pressure	:	1010 hPa
Test Power	:	DC 2V

#### 4.5. Test Data

The test item is not applicative.

**DRAFT**

## 5. Magnetic field emission Measurement

### 5.1. Test Standard and Limit

#### 5.1.1. Test Standard

EN IEC 55015: 2019/A11: 2020.

#### 5.1.2. Test Limit

Frequency			Limits for loop diameter (dB $\mu$ A)
			2m
9KHz	~	70KHz	88
70KHz	~	150KHz	88 ~ 58*
150KHz	~	2.2MHz	58 ~ 26*
2.2MHz	~	3.0MHz	58
3.0MHz	~	30MHz	22

**Remark:** 1. At the transition frequency the lower limit applies.  
2. \* Decreasing linearly with logarithm of the frequency.

### 5.2. Test Setup

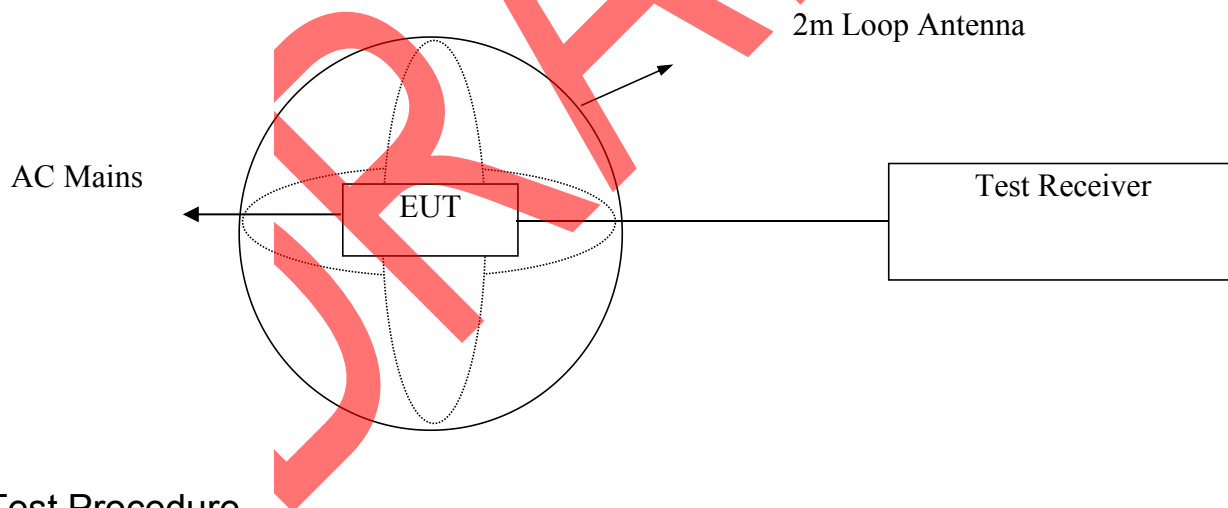

### 5.3. Test Procedure

The EUT is placed on a wood table in the center of a loop antenna. The induced current in the loop antenna is measured by means of a current probe and the test receiver. Three field components are checked by means of a coaxial switch.

The frequency range from 9KHz to 30MHz is investigated. The receiver is measured with the quasi-peak detector. For frequency band 9KHz to 150KHz, the bandwidth of the field strength meter is set at 200Hz. For frequency band 150KHz to 30MHz, the bandwidth is set at 9KHz.

---

---

#### 5.4. Test Condition

Temperature	:	25 °C
Relative Humidity	:	48 %
Pressure	:	1010 hPa
Test Power	:	DC 2V

#### 5.5. Test Data

Please refer to the following pages.

DRAFT

**Operating Mode: ON**  
**Test Specification: X Direction**

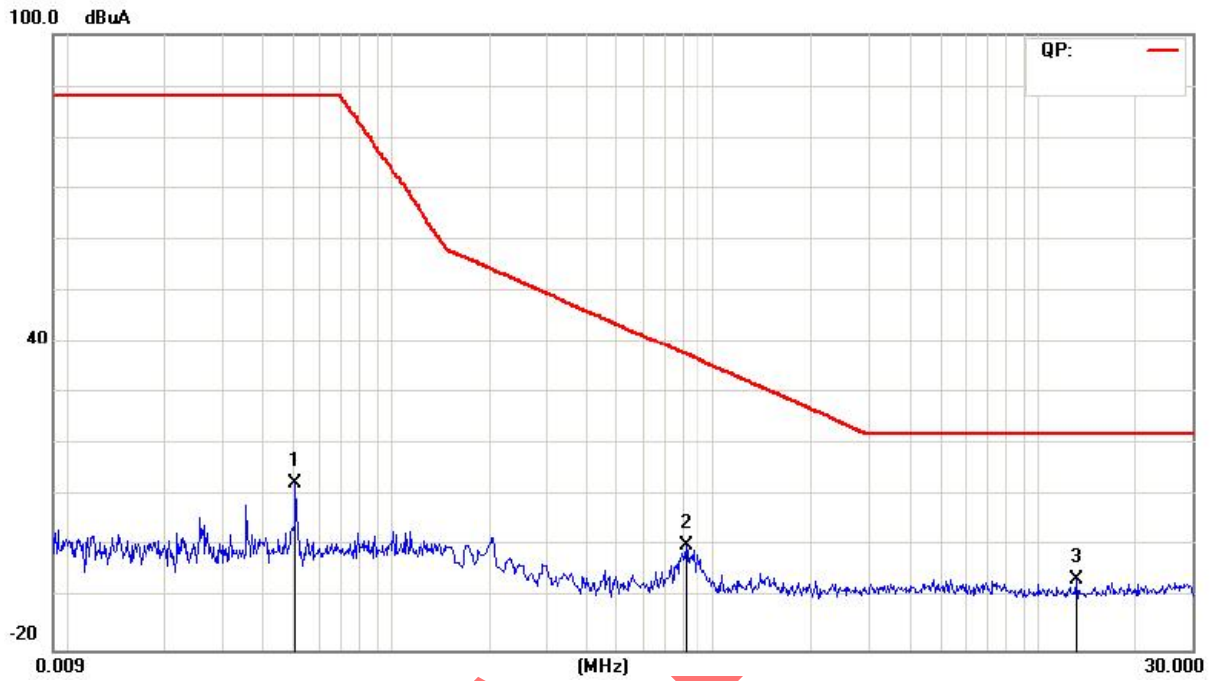

No.	Mk.	Freq.	Reading Level	Correct Factor	Measurement	Limit	Over	Detector	Comment
		MHz	dBuA	dB	dBuA	dBuA	dB		
1		0.0509	-7.58	20.00	12.42	88.00	-75.58	QP	
2		0.8180	-19.63	20.00	0.37	37.61	-37.24	QP	
3	*	13.1540	-26.47	20.00	-6.47	22.00	-28.47	QP	



**Operating Mode: ON**  
**Test Specification: Y Direction**

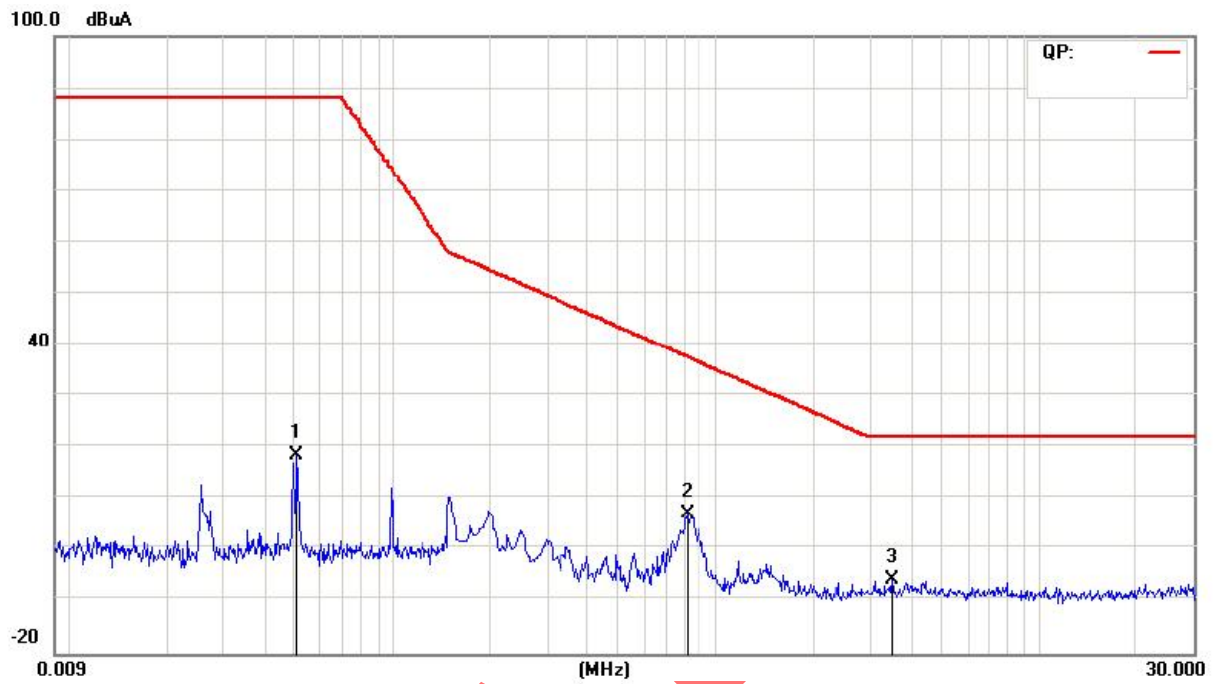

No.	Mk.	Freq. MHz	Reading Level dBuA	Correct Factor dB	Measure- ment dBuA	Limit dBuA	Over dB	Detector	Comment
1		0.0509	-1.41	20.00	18.59	88.00	-69.41	QP	
2		0.8180	-12.76	20.00	7.24	37.61	-30.37	QP	
3	*	3.5020	-25.76	20.00	-5.76	22.00	-27.76	QP	

**Operating Mode: ON**  
**Test Specification: Z Direction**

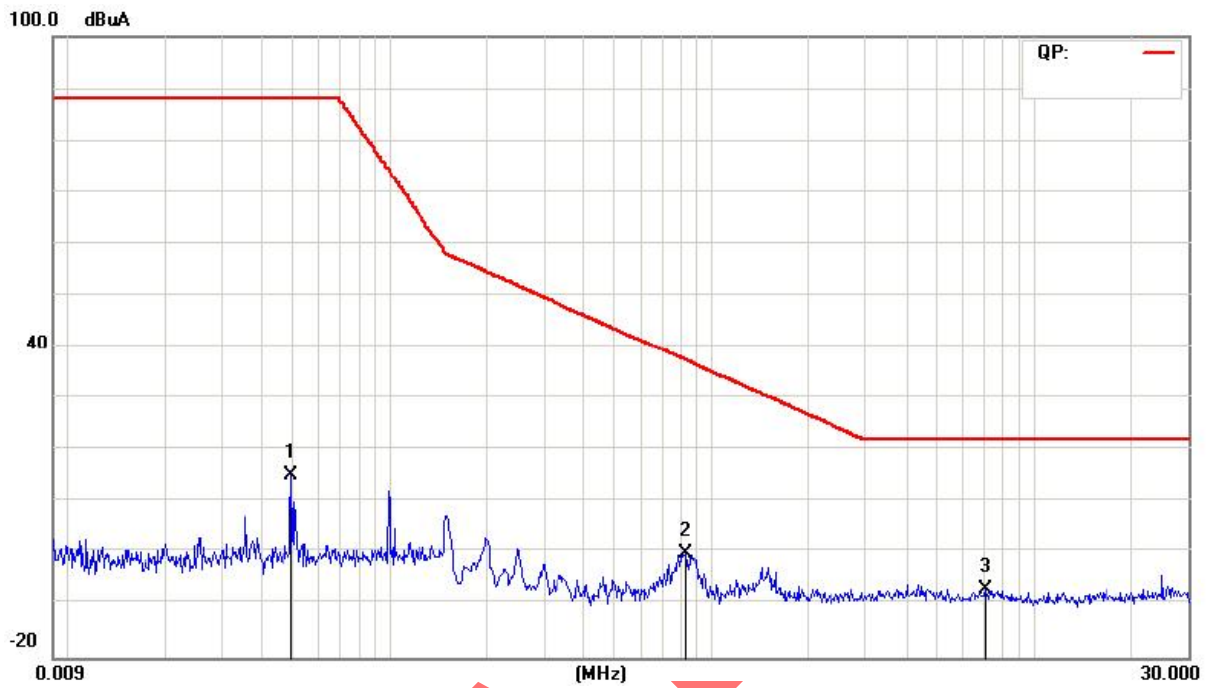

No.	Mk.	Freq. MHz	Reading Level dBuA	Correct Factor dB	Measure- ment dBuA	Limit dBuA	Over dB	Detector	Comment
1		0.0495	-4.73	20.00	15.27	88.00	-72.73	QP	
2		0.8300	-20.07	20.00	-0.07	37.44	-37.51	QP	
3	*	7.1300	-26.88	20.00	-6.88	22.00	-28.88	QP	

## 6. Radiated Disturbance Test

### 6.1. Test Standard and Limit

#### 6.1.1. Test Standard

EN IEC 55015: 2019/A11: 2020

#### 6.1.2. Test Limit

Radiated Disturbance Test Limit (Class B)

Frequency	Limit (dB $\mu$ V/m)
	Quasi-peak Level
30MHz~230MHz	40
230MHz~300MHz	47

**Remark:** 1. The lower limit shall apply at the transition frequency.  
2. The test distance is 3m.

### 6.2. Test Setup

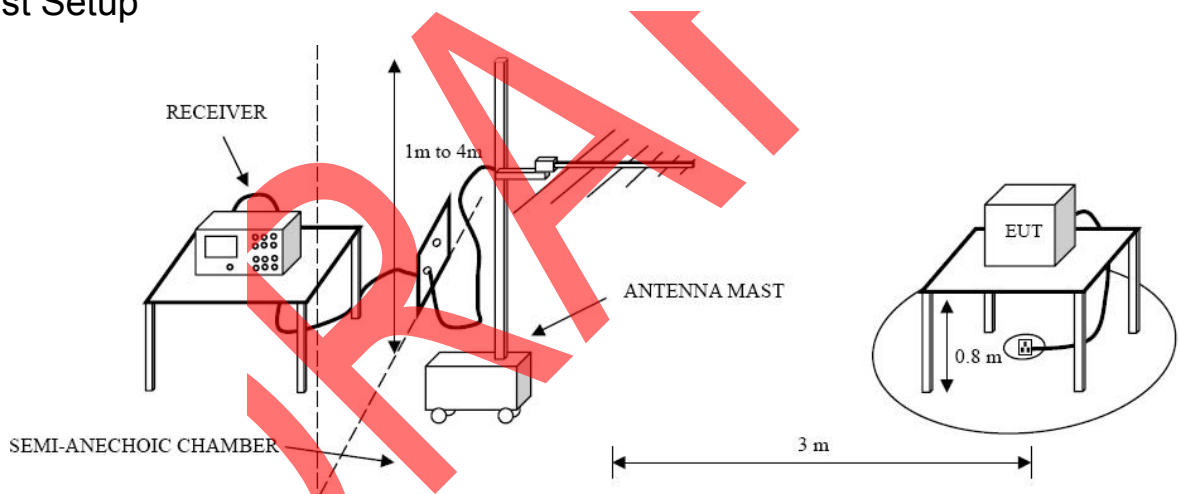

### 6.3. Test Procedure

The EUT was placed on the top of a rotating table 0.8 meters above the ground at a 3m. The table was rotated 360 degrees to determine the position of the highest radiation.

The height of the equipment or of the substitution antenna shall be 0.8 m; the height of the test antenna shall vary between 1 m to 4 m. Both horizontal and vertical polarizations of the antenna are set to make the measurement.

The initial step in collecting radiated emission data is a spectrum analyzer peak detector mode pre-scanning the measurement frequency range. Significant peaks are then marked and then Quasi Peak detector mode re-measured.

If the Peak Mode measured value compliance with and lower than Quasi Peak Mode

---

Limit, the EUT shall be deemed to meet QP Limits and then no additional QP Mode measurement performed.

#### 6.4. Test Condition

Temperature	:	25 °C
Relative Humidity	:	48 %
Pressure	:	1010 hPa
Test Power	:	DC 2V

#### 6.5. Test Data

Please refer to the following pages.

DRAFT

**Operating Mode: ON**  
**Test Specification: Horizontal**

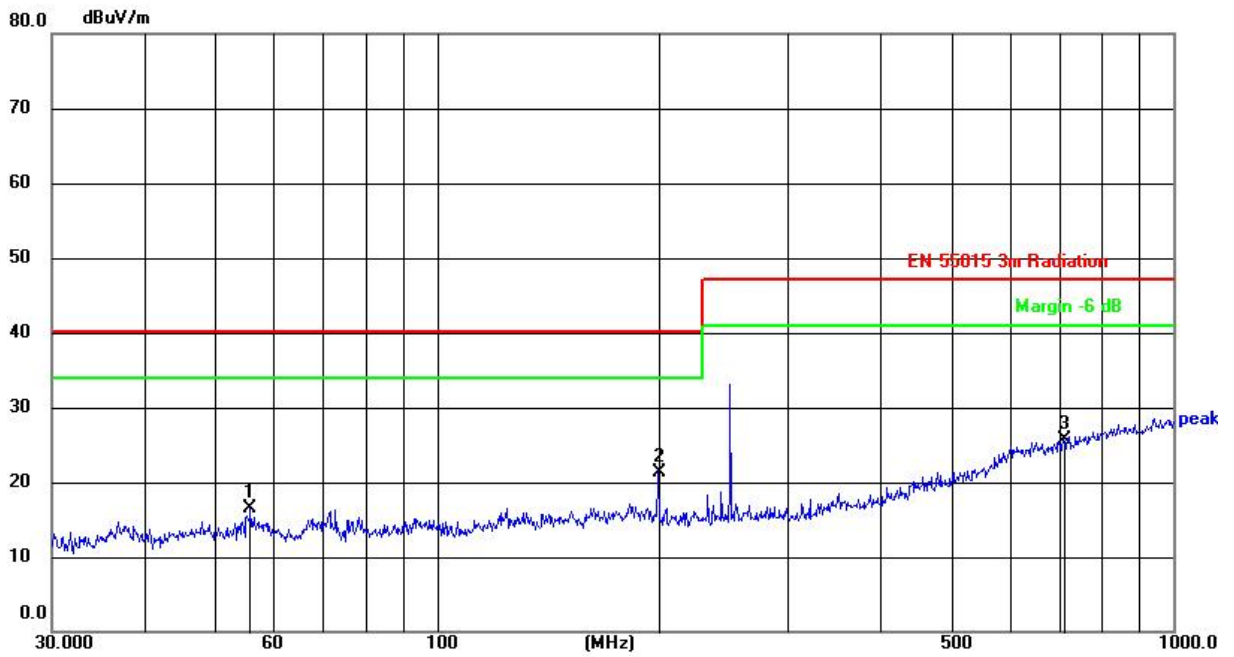

No.	Frequency (MHz)	Reading (dBuV)	Factor (dB/m)	Level (dBuV/m)	Limit (dBuV/m)	Margin (dB)	Detector	Height (cm)	Azimuth (deg.)	P/F	Remark
1	55.8047	37.43	-20.88	16.55	40.00	-23.45	peak				
2	199.9856	39.86	-18.56	21.30	40.00	-18.70	peak				
3	709.1823	34.70	-8.93	25.77	47.00	-21.23	peak				

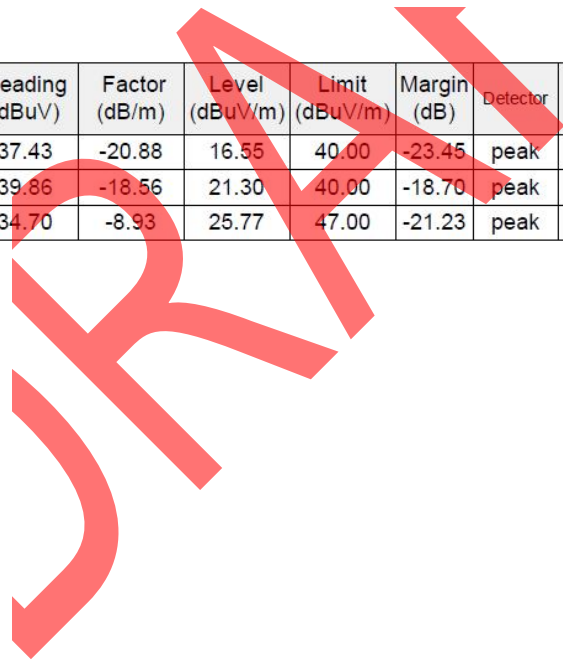

**Operating Mode: ON**  
**Test Specification: Vertical**

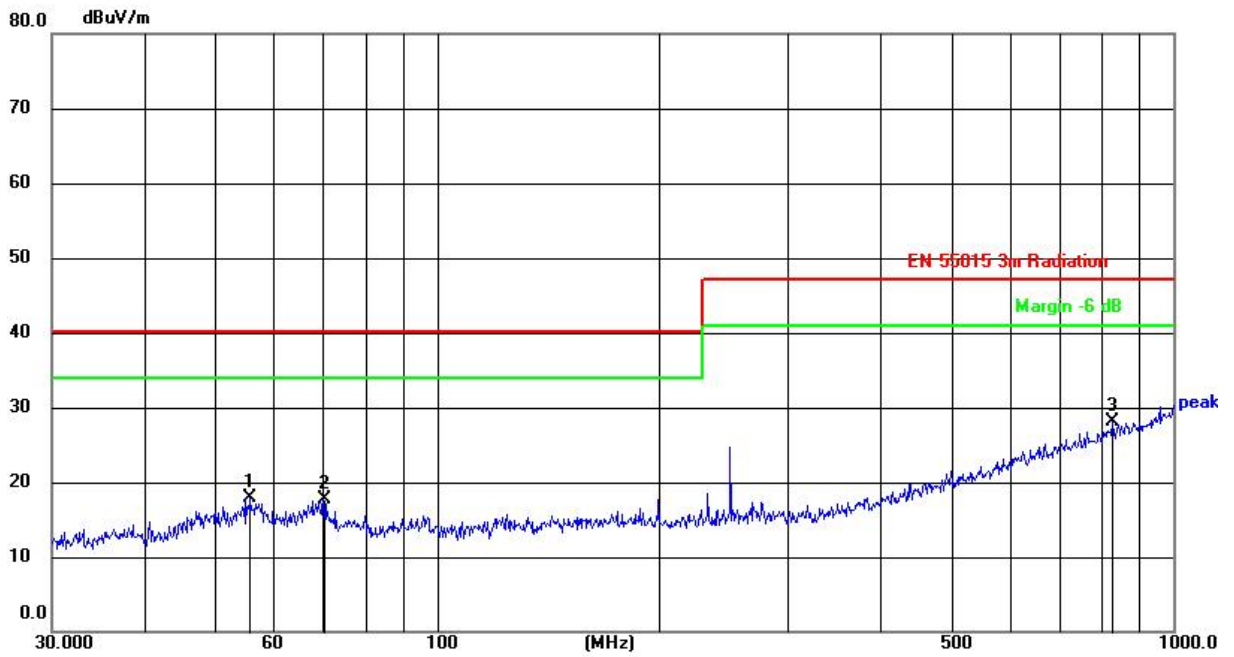

No.	Frequency (MHz)	Reading (dBuV)	Factor (dB/m)	Level (dBuV/m)	Limit (dBuV/m)	Margin (dB)	Detector	Height (cm)	Azimuth (deg.)	P/F	Remark
1	55.8047	38.75	-20.84	17.91	40.00	-22.09	peak				
2	70.0903	38.33	-20.55	17.78	40.00	-22.22	peak				
3	827.4934	35.19	-7.03	28.16	47.00	-18.84	peak				

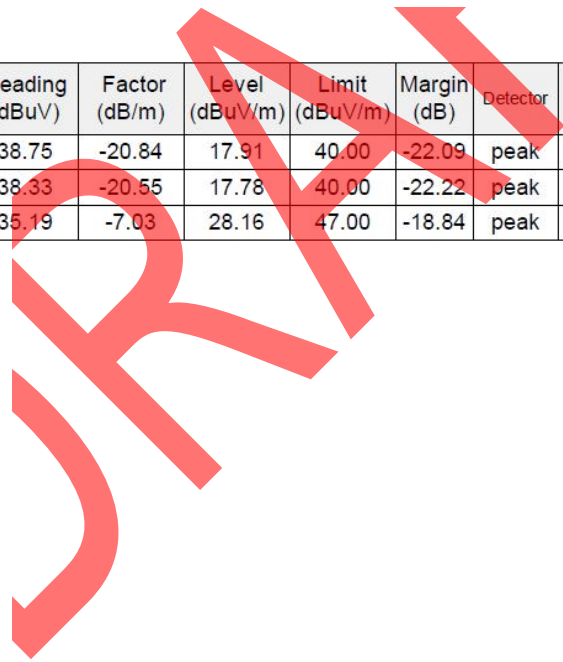

## 7. Electrostatic Discharge Immunity Test

### 7.1. Test Requirements

#### 7.1.1. Test Standard

EN 61547: 2009 (EN 61000-4-2: 2009)

#### 7.1.2. Test Level

Level	Test Voltage Contact Discharge (kV)	Test Voltage Air Discharge (kV)
1	±2	±2
2	±4	±4
3	±6	±8
4	±8	±15
X	Special	Special

#### 7.1.3. Performance criterion: **B**

### 7.2. Test Setup

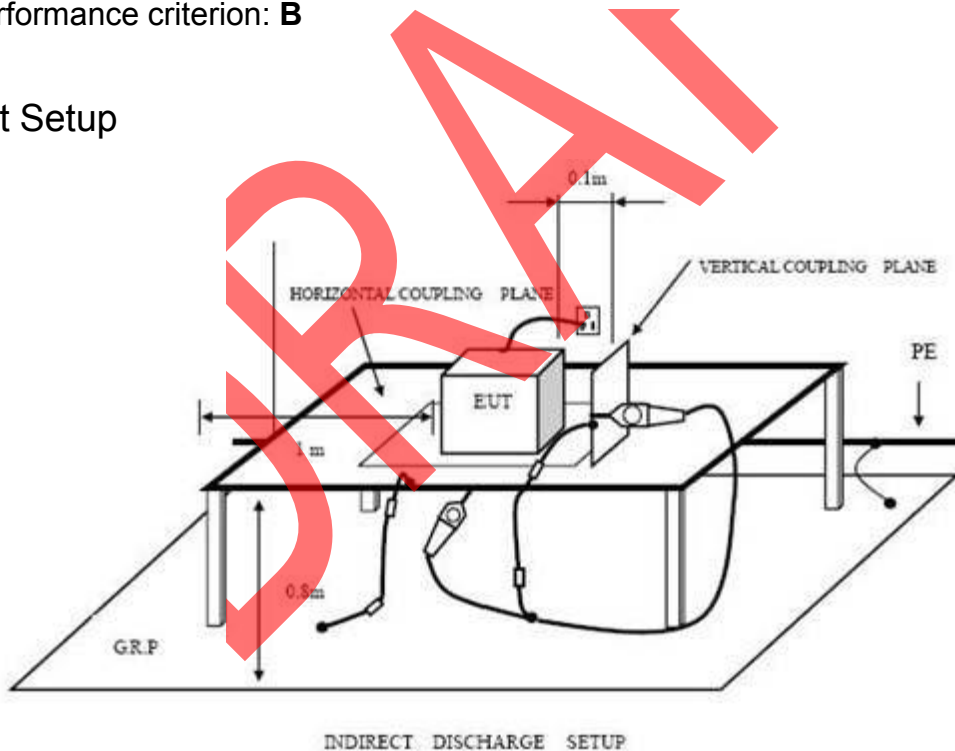

### 7.3. Test Procedure

#### 7.3.1. Air Discharge:

This test is done on a non-conductive surface. The round discharge tip of the discharge electrode shall be approached as fast as possible to touch the EUT. After each discharge, the discharge electrode shall be removed from the EUT. The generator is then re-triggered for a new single discharge and repeated 10 times for

each pre-selected test point. This procedure shall be repeated until all the air discharge completed.

#### 7.3.2. Contact Discharge:

All the procedure shall be same as air discharge. Except that the tip of the discharge electrode shall touch the EUT before the discharge switch is operated.

#### 7.3.3. Indirect discharge for horizontal coupling plane

At least 10 single discharges (in the most sensitive polarity) shall be applied at the front edge of each HCP opposite the center point of each unit (if applicable) of the EUT and 0.1m from the front of the EUT. The long axis of the discharge electrode shall be in the plane of the HCP and perpendicular to its front edge during the discharge.

#### 7.3.4. Indirect discharge for vertical coupling plane

At least 10 single discharges (in the most sensitive polarity) shall be applied to the center of one vertical edge of the coupling plane. The coupling plane, of dimensions 0.5m X 0.5m, is placed parallel to, and positioned at a distance of 0.1m from the EUT. Discharges shall be applied to the coupling plane, with this plane in sufficient different positions that the four faces of the EUT are completely illuminated.

### 7.4. Test Data

Please refer to the following page.

**DRAFT**



## Electrostatic Discharge Test Result

EUT : <u>Solar cell box</u>	M/N : <u>ZS202211DCDL</u>	
Temperature : <u>22°C</u>	Humidity : <u>50%</u>	
Power supply : <u>DC 2V</u>	Test Mode : <u>Normal</u>	
Criterion: B		
Air Discharge: $\pm 8kV$ Contact Discharge: $\pm 4kV$		
For each point positive 10 times and negative 10 times discharge.		
Location	Kind A-Air Discharge C-Contact Discharge	Result
Nonconductive Enclosure	A	PASS
Slots of EUT	A	PASS
Button	A	PASS
Screw	C	PASS
HCP	C	PASS
VCP of front	C	PASS
VCP of rear	C	PASS
VCP of left	C	PASS
VCP of right	C	PASS
<b>Remark:</b>		

## 8. Radiated Electromagnetic Field Immunity Test

### 8.1. Test Requirements

#### 8.1.1. Test Standard

EN 61547: 2009 (EN IEC 61000-4-3: 2020)

#### 8.1.2. Test Level

Level	Field Strength V/m
1	1
2	3
3	10
X	Special

#### 8.1.3. Performance criterion: **A**

### 8.2. Test Setup

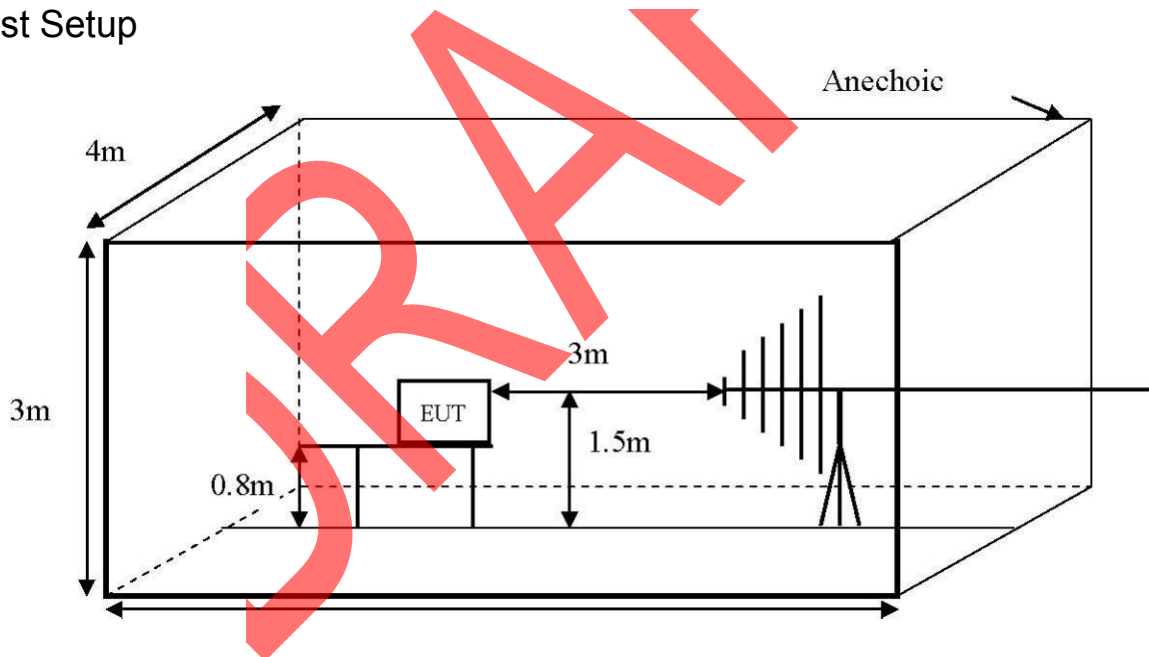

### 8.3. Test Procedure

The EUT are placed on a table, which is 0.8 meter high above the ground. The EUT is set 3 meters away from the transmitting antenna, which is mounted on an antenna tower. Both horizontal and vertical polarization of the antenna is set on test. Each of the four sides of the EUT must be faced this transmitting antenna and measured individually.

In order to judge the EUT performance, a camera is used to monitor its screen.

All the scanning conditions are as following:

Condition of Test	Remark
Fielded strength	3V/m (Severity Level 2)
Radiated signal	Modulated
Scanning frequency	80-1000MHz
Sweep time of radiated	0.0015 Decade/s
Dwell time	1 Sec.

#### 8.4. Test Data

Please refer to the following page.

DRAFT

## RF Field Strength Susceptibility Test Results

EUT	: <u>Solar cell box</u>	M/N	: <u>ZS202211DCDL</u>	
Temperature	: <u>22°C</u>	Humidity	: <u>50%</u>	
Power supply	: <u>DC 2V</u>	Test Mode	: <u>Normal</u>	
Criterion: A				
Modulation: Unmodulated				
Pulse: AM 1KHz 80%				
	Frequency Rang 1		Frequency Rang 2	
	80~1000MHz		/	
	Horizontal	Vertical	Horizontal	Vertical
Front	PASS	PASS	/	/
Right	PASS	PASS	/	/
Rear	PASS	PASS	/	/
Left	PASS	PASS	/	/
<b>Remark:</b>				

## 9. Photographs - Constructional Details

Photo 1 Appearance of EUT

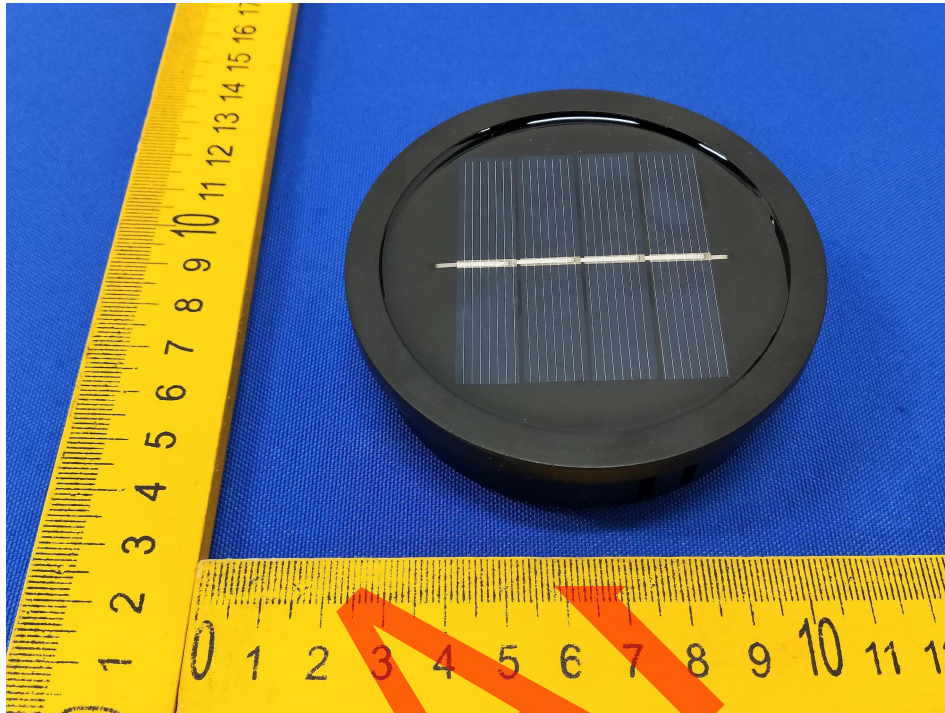
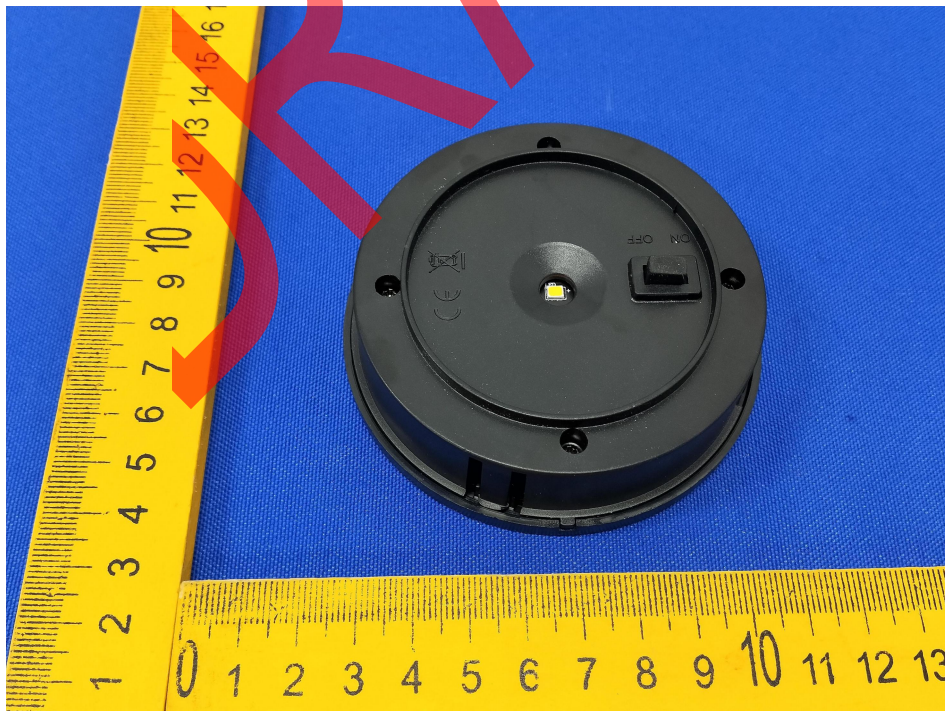

Photo 2 Appearance of EUT

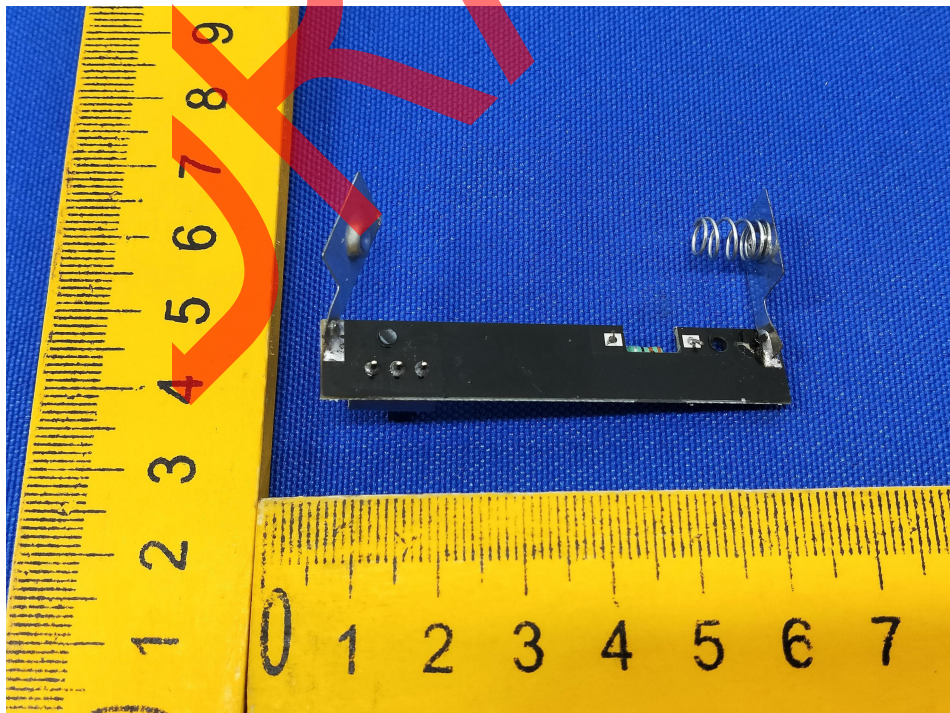



**Photo 3 Inside of EUT**

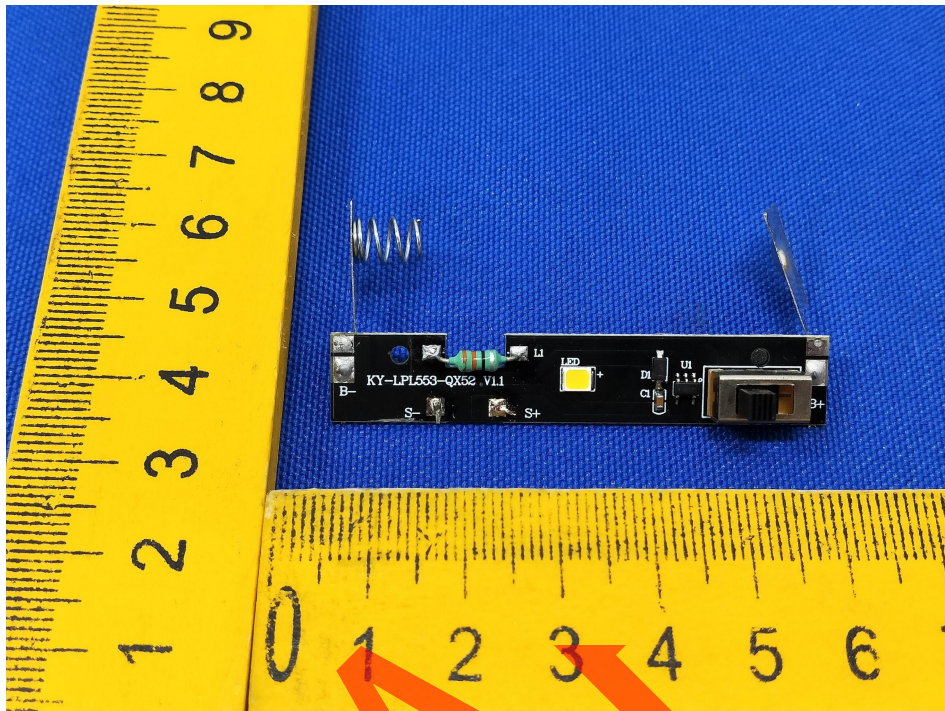

**Photo 4 Appearance of PCB**





**Photo 5 Appearance of PCB**



**Photo 6 Appearance of Battery**



**Photo 7 Appearance of Battery**



**END OF REPORT**

**DRAFT**