



NINJAGO

71787



1



 **FR**
DONNEZ
OU
RECYCLEZ

 OU  OU 

ASSOCIATION MAGASIN DÉCHÈTERIE

Adresses sur quefairedemesdechets.fr



LEGO.com/sustainable-packaging



BUILDER



Apple and the Apple logo are trademarks of Apple Inc., registered in the U.S. and other countries and regions. App Store is a service mark of Apple Inc. Google Play and the Google Play logo are trademarks of Google LLC. Tencent and the Tencent logo are trademarks of Tencent Inc.

Q [LEGO.com/devicecheck](https://www.lego.com/devicecheck)

EN Ask parents' permission before going online | **DE** Eltern um Erlaubnis bitten, bevor du online gehst | **FR** Demande l'autorisation d'un parent avant d'aller en ligne | **IT** Chiedi il permesso ai tuoi genitori prima di andare online | **ES** Pídeles permiso a tus papás antes de conectarte a Internet | **PT** Pede autorização aos pais antes de acederes online | **JA** オンラインになる前にほご者の方のきよかをもらおう | **ZH** 上网前应先征得父母的同意 | **KO** 온라인 접속 전에 보호자 동의가 필요합니다 | **RU** Спроси разрешения у родителей, прежде чем заходить в интернет | **PL** Poproś rodziców o zgodę, zanim wejdziesz do Internetu | **CS** Než půjdeš na internet, požádej rodiče o svolení | **SK** Skôr než pôjdeš na internet, vypýtaj si povolenie od rodičov | **HU** Kérj szülői engedélyt, mielőtt online csatlakoznál! | **RO** Cere permisiunea părinților înainte de a te conecta online | **BG** Поискайте разрешение от родител, преди да влезете онлайн | **LV** Pirms došanās tiešsaistē palūdz atļauju vecākiem | **ET** Enne Interneti kasutamist küsi vanematelt luba | **LT** Prieš prisijungdami prie interneto, atsklauskite tėvų

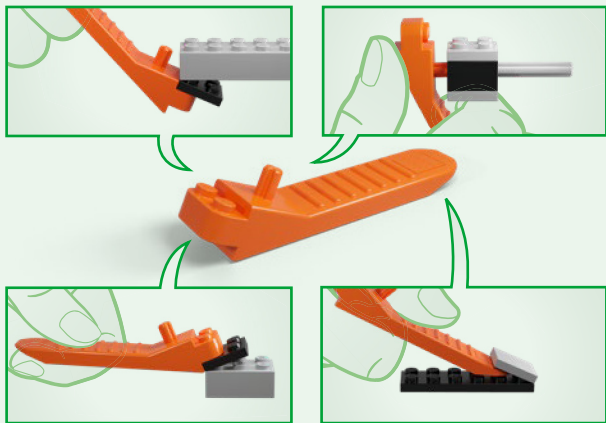

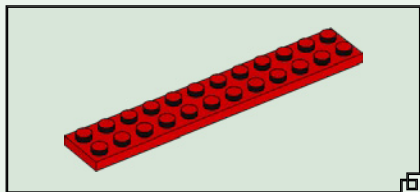
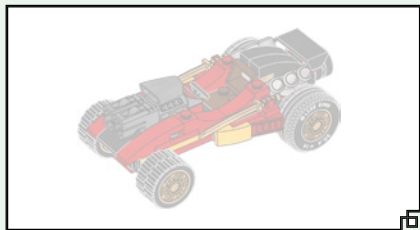
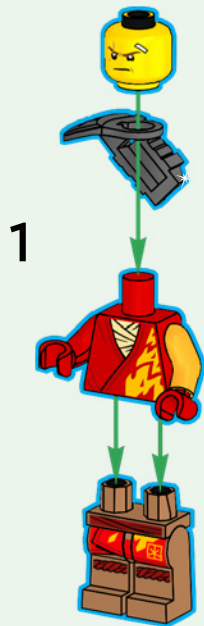

1

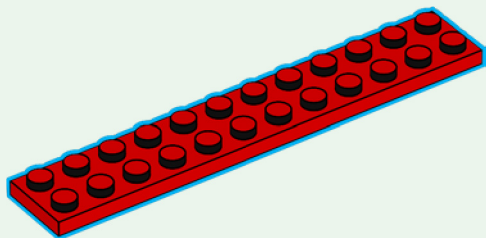

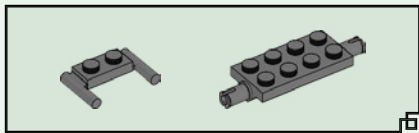

2

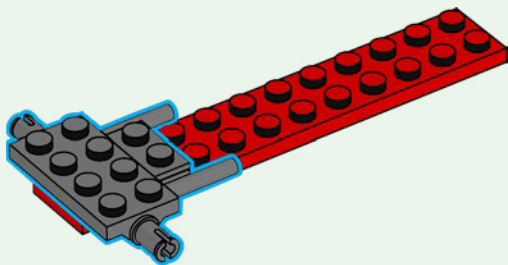

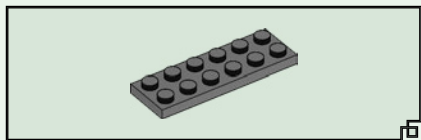

3

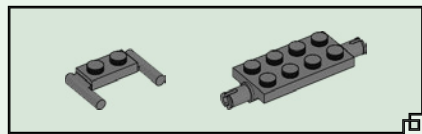
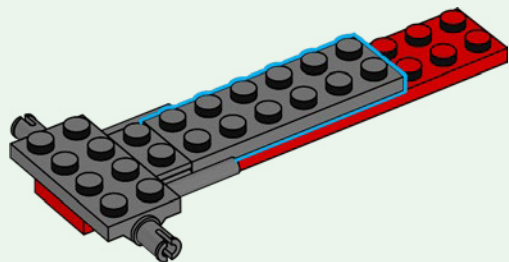

4

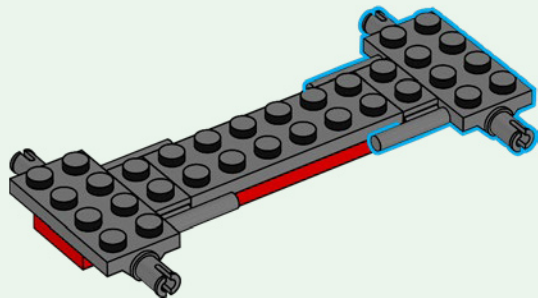

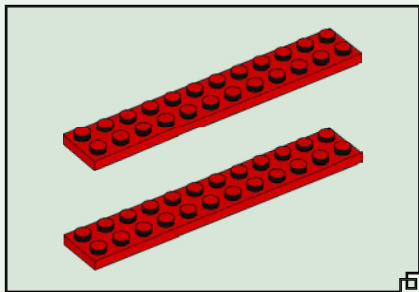

5

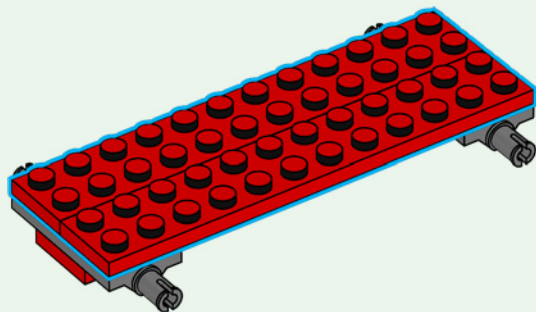

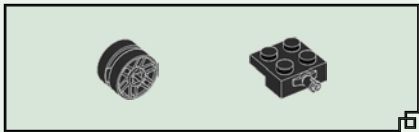

6

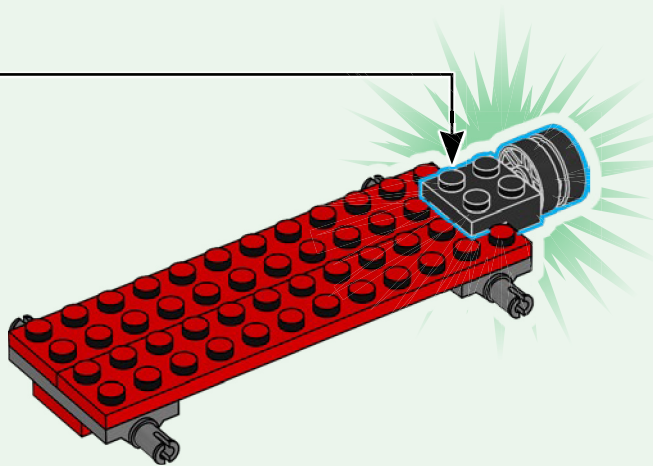
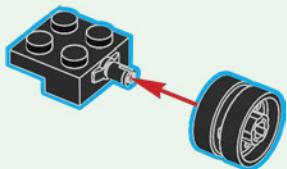

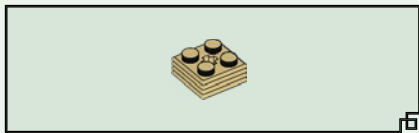

7

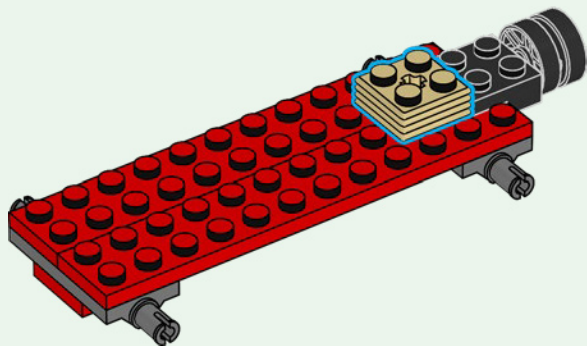

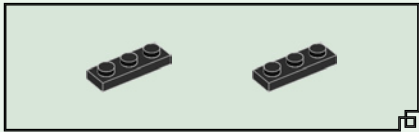

8

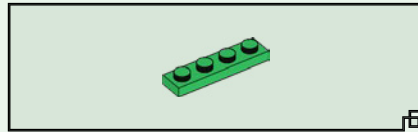
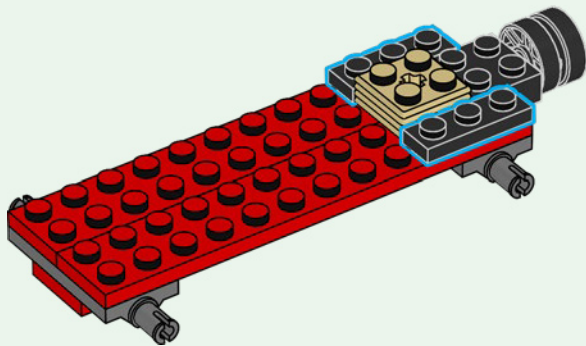

9

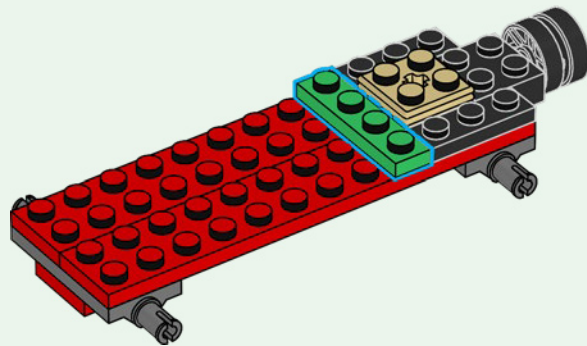

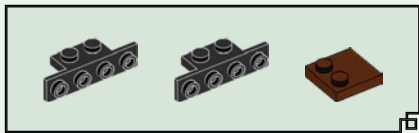

10

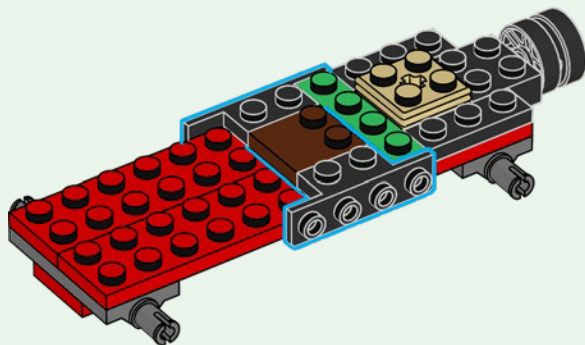



11

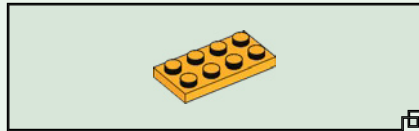
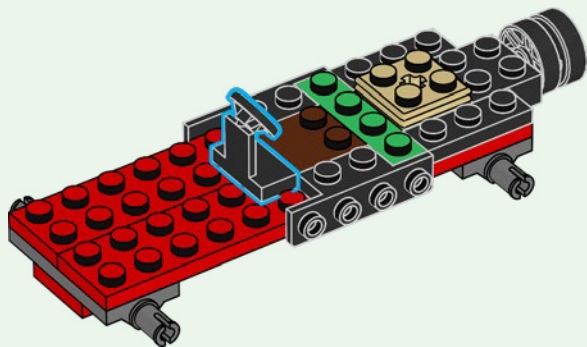

12

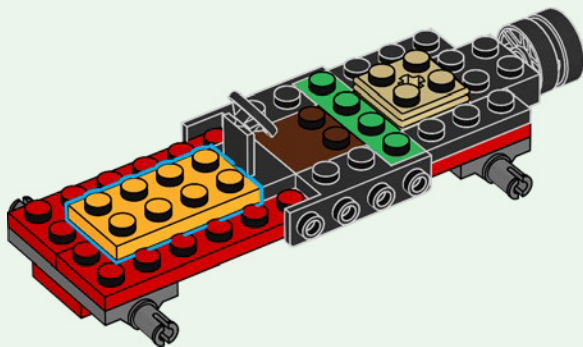

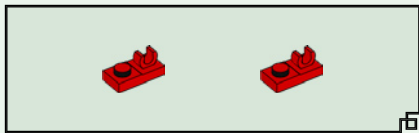

15

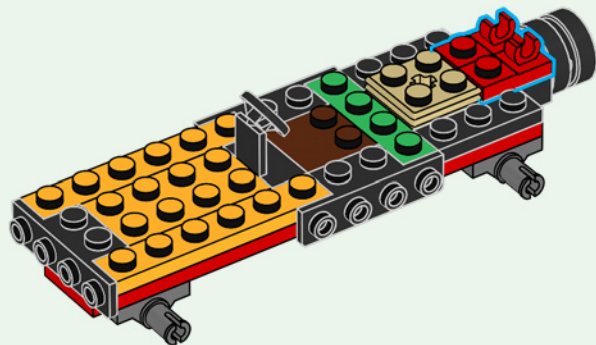

16



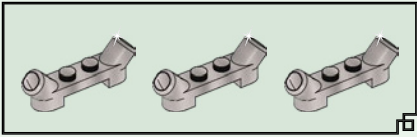

16

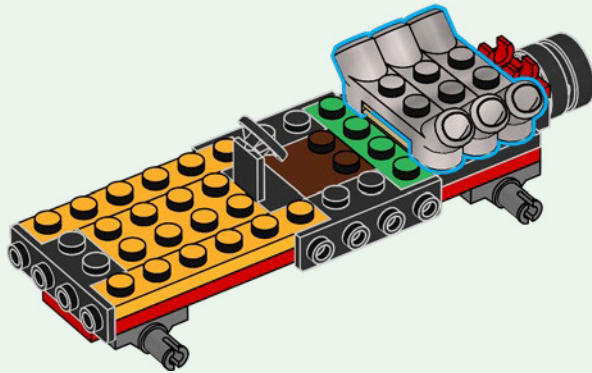



17

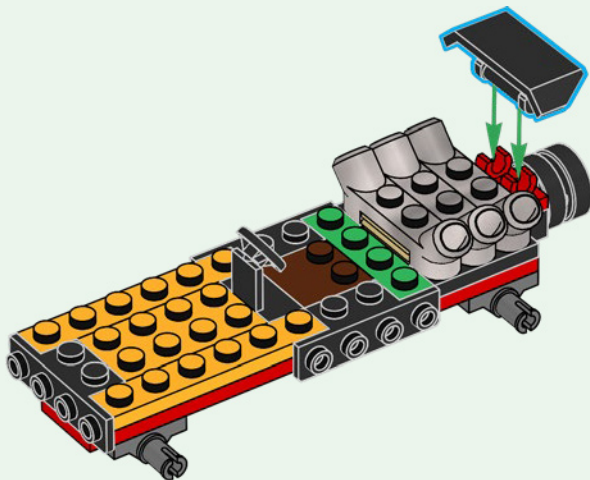

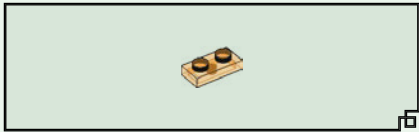

18

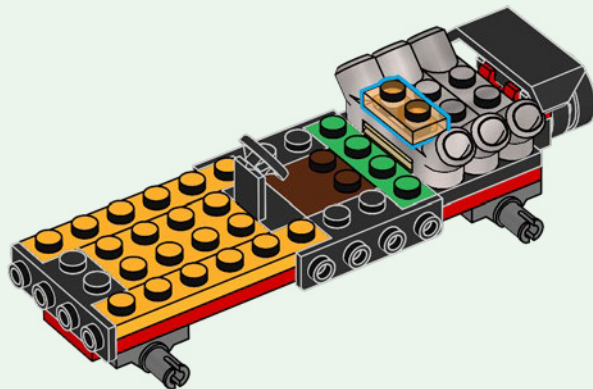

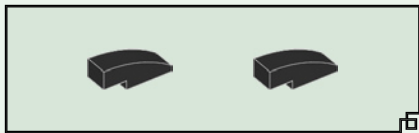

19

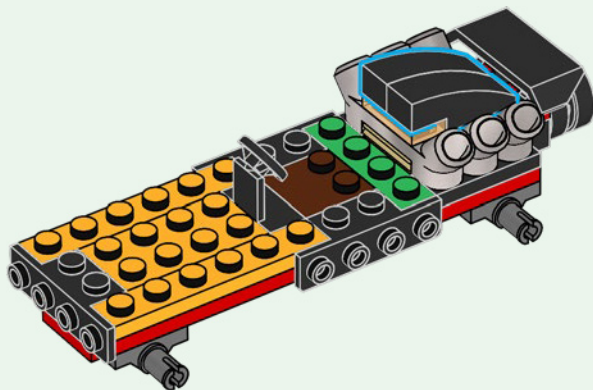

20





20

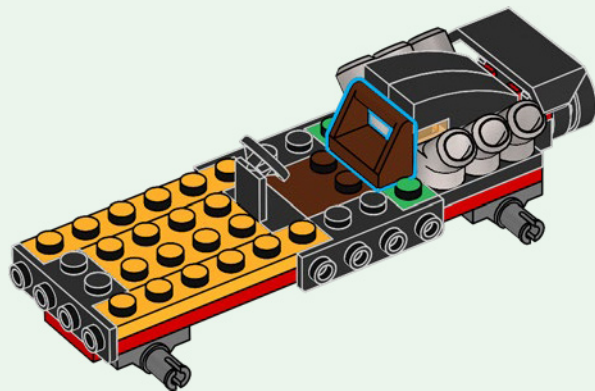

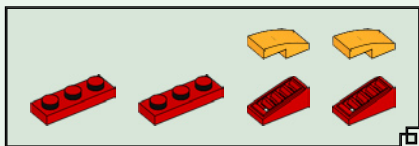
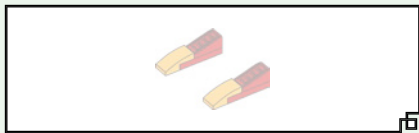

21

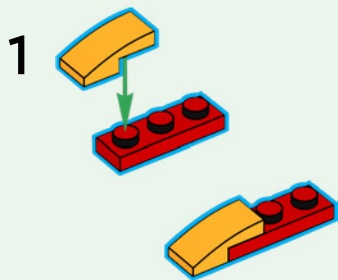

2

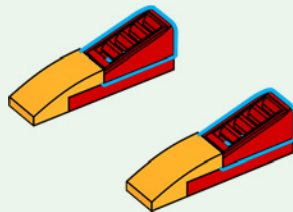

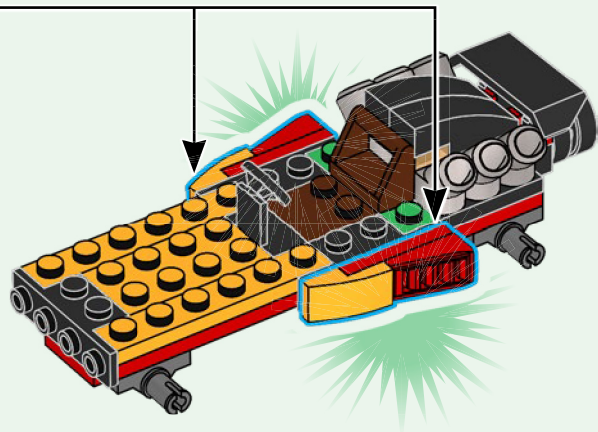

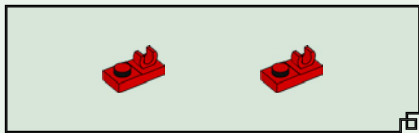

22

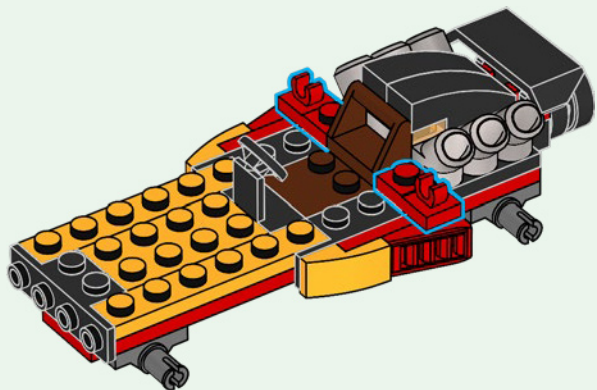

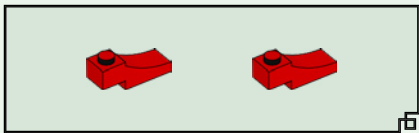

23

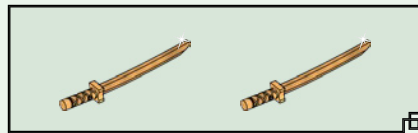
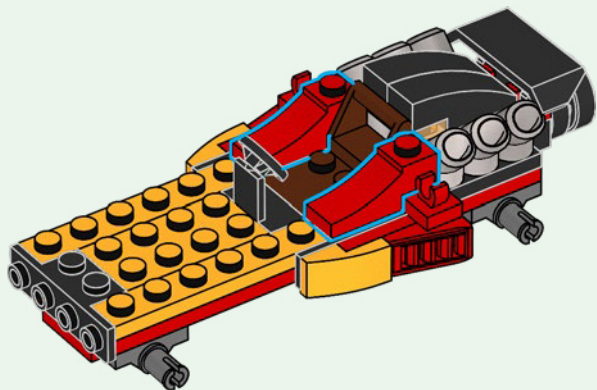

24

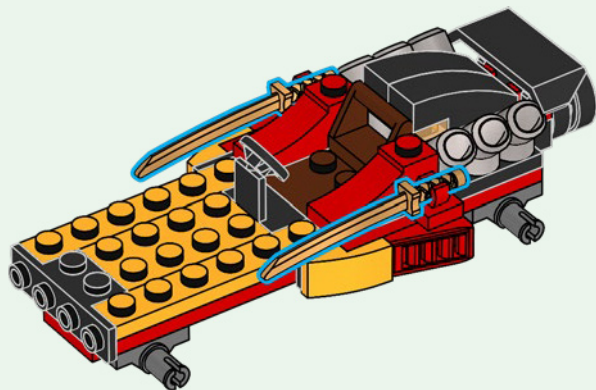

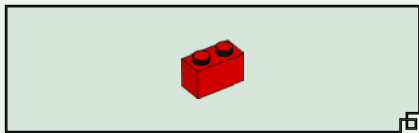

25

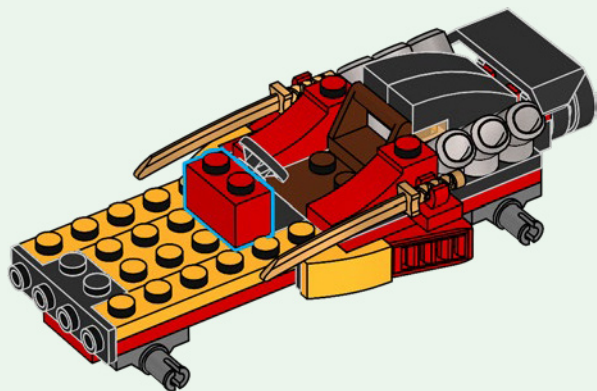

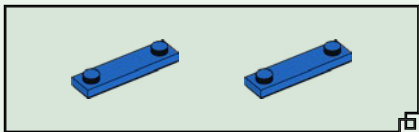

26

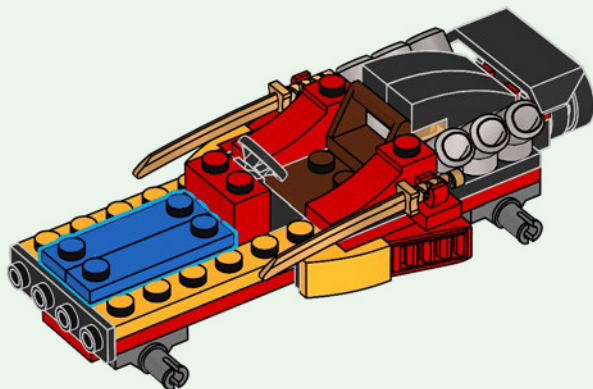

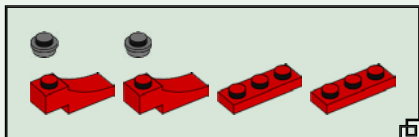
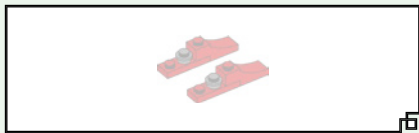

27

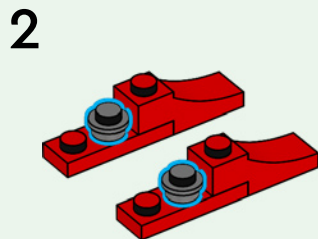
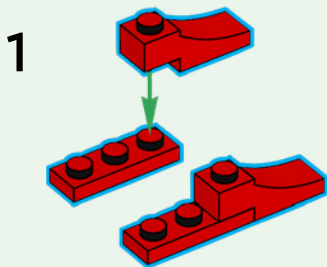

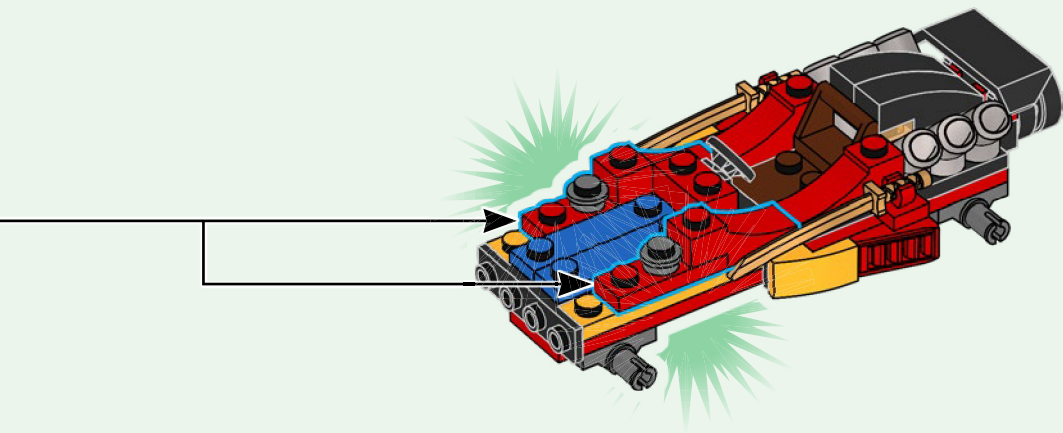



28

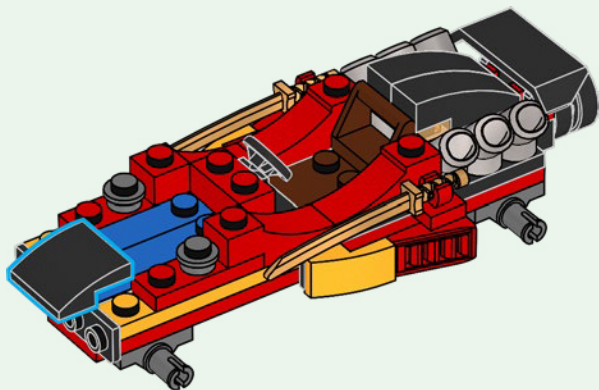

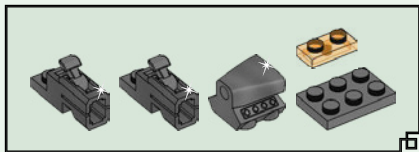

31



1

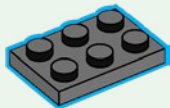

2



3

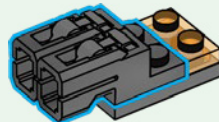

4

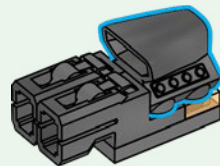

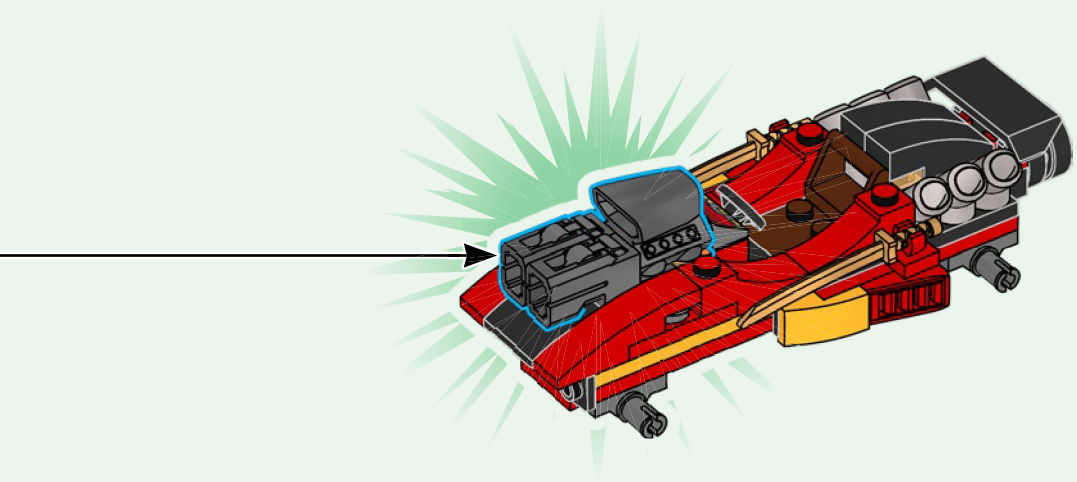

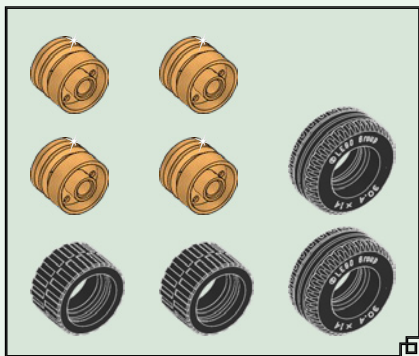
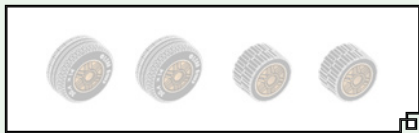

32

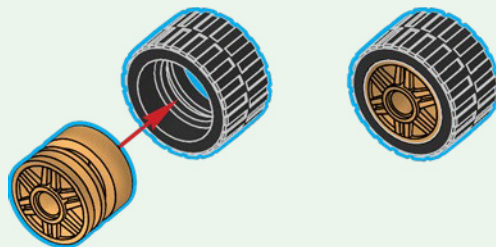
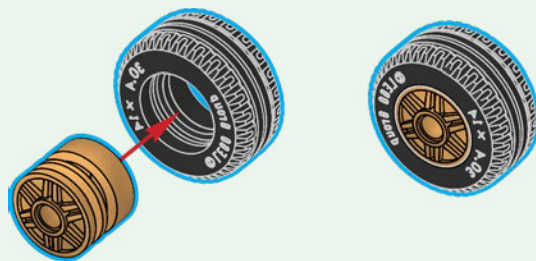

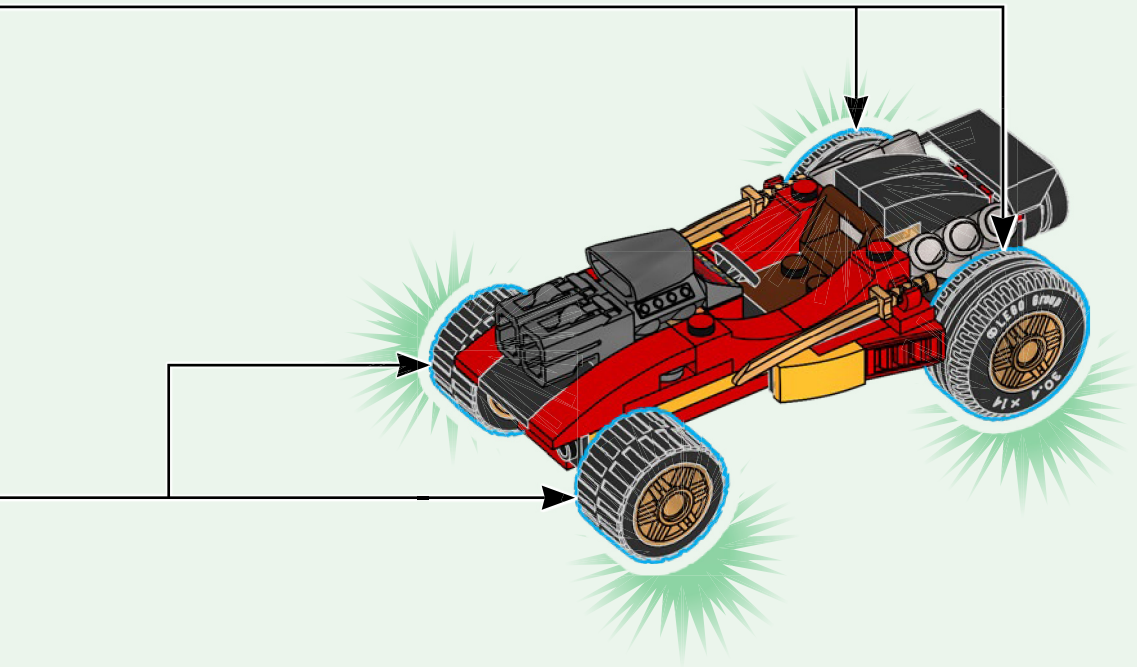

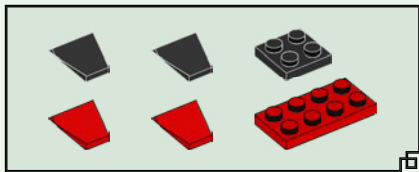

33

1

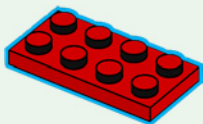

2

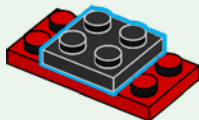

3

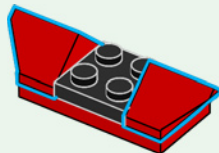

4

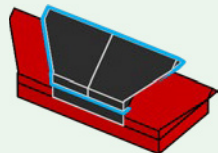

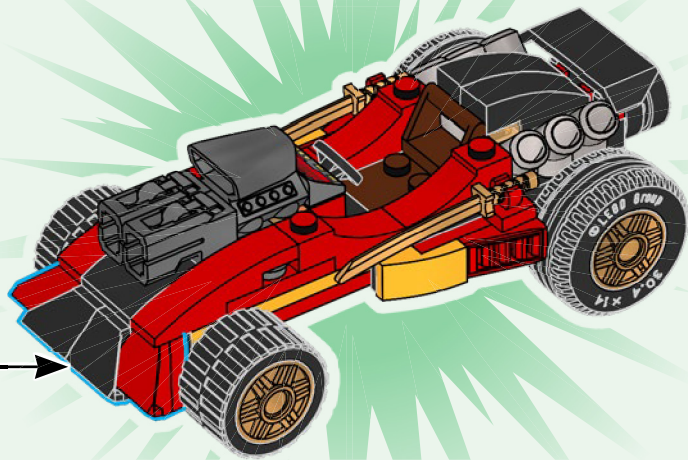

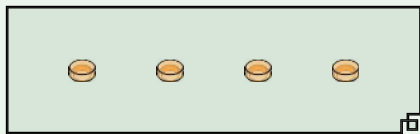

34

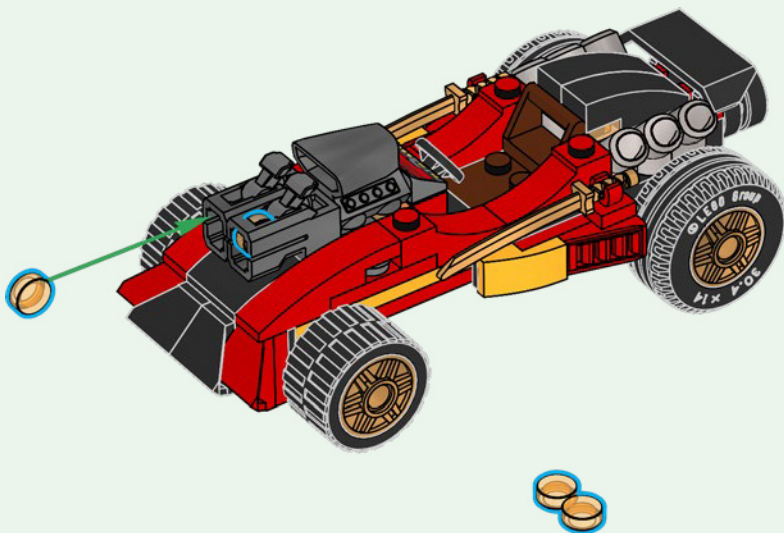

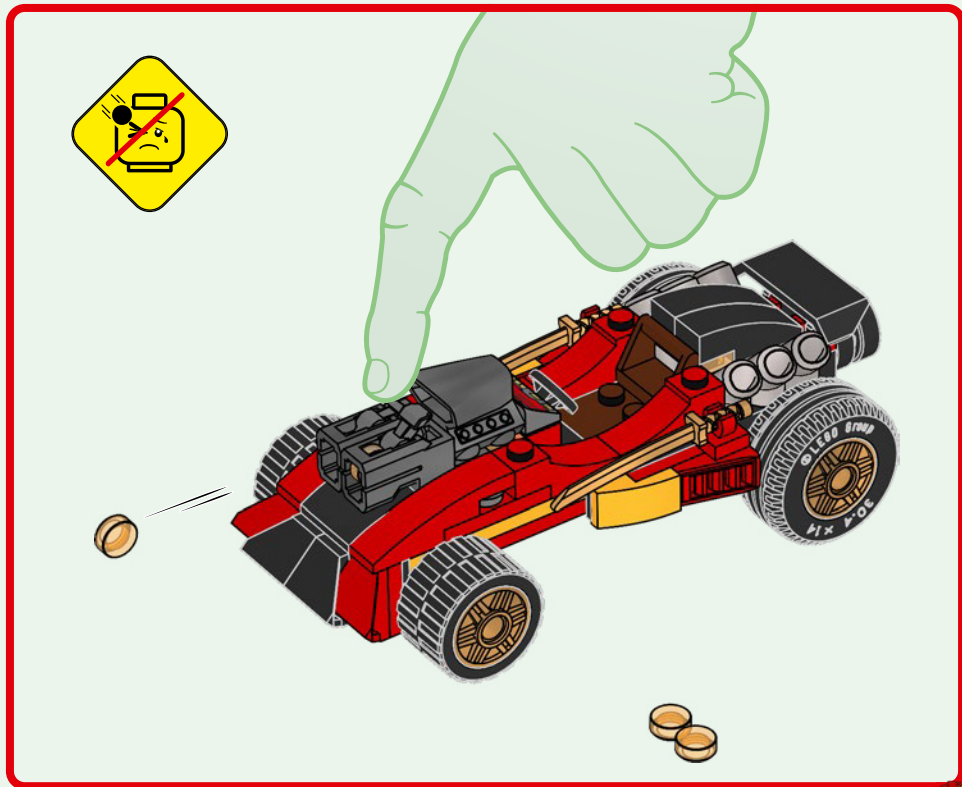

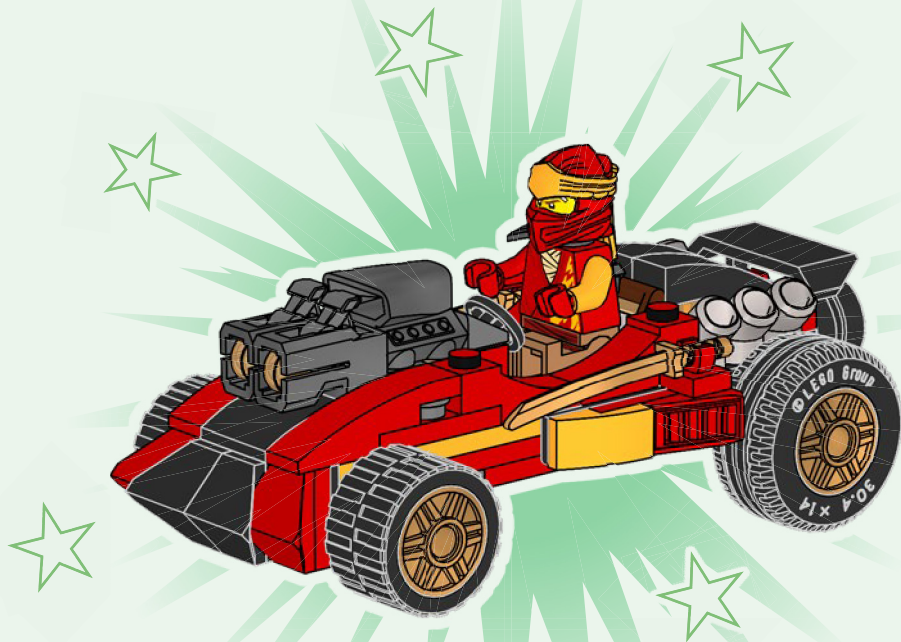

EXPLORE MORE!

Explore more / Mehr entdecken / En savoir plus / Esplora di più /
Explora más / Explora mais / 探索更多 / Узнайте больше /
Zobacz więcej / Objev více / Objav viac / Tudj meg többet! /
Descoperă mai multe / Разгледайте още / Uzzini vairāk /
Uuri lähemalt / Atrask daugiau



Blue-Ocean-AG.com/LEGONinjagoMagazine

Flag Illustrations: stockdevil - stock.adobe.com

Flag Illustrations / Abgebildete Flaggen / Illustrations de drapeaux / Illustrazioni delle bandiere /
Ilustraciones de banderas / Ilustrações de bandeiras / 旗帜插图 / Иллюстрации флагов /
Ilustracje — flagi / Obrazy vlajok / Obrázky vlajok / Záslo ilustráciok / Ilustrati cu steaguri /
Иллюстрации на знамена / Karogu atēli / Lippude pildid / Vėliavų iliustracijos

INSPIRATION BUILDS EXTEND THE FUN AND BUILD YOUR OWN CREATIONS!

Inspiration Builds – Extend the fun and build your own creations!

Bauideen – Baue deine eigenen Modelle für weitere Abenteuer!

Idées de construction – Prolonge le jeu en construisant tes propres créations !

Costruzioni ispiratrici – Continua il divertimento e realizza le tue creazioni!

Modelos para inspirarte – ¡Sigue divirtiéndote y construye tus propias creaciones!

Modelos de inspiração – Prolonga a diversão e constrói as tuas próprias criações!

创意模型 – 扩展乐趣，拼搭属于你自己的作品！

Модели для вдохновения – Еще больше удовольствия со сборкой собственных творений!

Inspirujące budowle – Baw się dłużej, budując własne modele!

Nápady na modely – Stavěj vlastní výtvary a užij si ještě více zábavy!

Nápady na modely – Postav si vlastné výtvary a užij si ešte viac zábavy!

Inspiráló építmények – A még izgalmasabb játékhoz építsd meg saját alkotásaidat!

Construcții care inspiră – Extinde distracția și construiește propriile tale creații!

Вдохновляющие конструкции – Создавайте свои собственные творения за още повече забавление!

Iedvesmojoši modeļi – Būvē pats savus modeļus un gūsti vēl vairāk prieka!

Inspireerivad mudelid – Suurenda rõõmu ja ehita oma looming!

Įkvėpiantys modeliai – Nevaržomai pramogauk ir konstruok savo kūrinčius!





YOU COULD
WIN



Scan this QR code or go to
LEGO.COM/PRODUCTFEEDBACK and give us
your short feedback about this LEGO® set for
a chance to win a cool LEGO prize.

Terms and Conditions apply*



DE: Du könntest GEWINNEN. Es gelten die Teilnahmebedingungen* **FR: Tu pourrais GAGNER.** Des conditions s'appliquent* **IT: Potresti VINCERE tu.** Termini e condizioni sono applicabili* **ES: Puedes GANAR.** Aplican términos y condiciones* **PT: Poderá GANHAR.** Aplicam-se termos e condições* **JA: プレゼント付き! 利用規約が適用されます*** **ZH: 轻松获奖. 条款和条件适用*** **KO: 상품의 주인이 되어보세요. 소정의 약관이 적용됩니다*** **RU: Вы можете ВЫИГРАТЬ.** Действуют положения и условия* **PL: Szansa na WYGRANĄ.** Obowiązują warunki korzystania* **CS: Máte šanci VYHRÁT.** Platí všeobecné smluvní podmínky* **SK: Máte šancu VYHRAŤ.** Platia všeobecné zmluvné podmienky* **HU: TE IS NYERHETSZ.** Felhasználási feltételek érvényesek* **RO: Ai putea CÂȘTIGA.** Se aplică termeni și condiții* **BG: Можете да СПЕЧЕЛИТЕ.** Има определени правила и условия* **LV: Tu vari LAIMĒT.** Ir spēkā noteikumi un nosacījumi.* **ET: Sul on võimalus VÕITA.** Kehtivad tingimused* **LT: Jūs galite LAIMĖTI.** Taikomos sąlygos*
*LEGO.com/productfeedback-terms