

ENG



**RECHARGEABLE HEADLIGHT**  
**AMPP800™**

HL-EL088RC  
**Manual**

**Before using the light, read this manual thoroughly and keep it for future reference.**

Design Pat. Pending  
Copyright © 2019 CATEYE Co., Ltd.  
HLEL088RC-190327 1



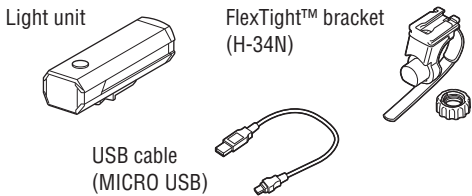

**! Before Initial Use**

This unit is shipped with small charge to check the light. Be sure to charge it before use, according to the instructions "HOW TO CHARGE" and "Cautions on recharging".

**! WARNING!!!**

- Be sure to direct the light beam downward so approaching car or pedestrian are not dazzled.
- Before your trip, please make sure the light is firmly mounted to the bracket and it lights up.
- Always pay attention to the remaining battery power by checking the indicator periodically while using the light.

**! CAUTION!**

- Keep the light away from children.
- Mounting the light unit too close to a wireless computer may adversely affect the reading of the computer.
- In preparation for unexpected shutoff, we recommend you carry a spare light.
- This product is water-resistant under normal daily use and can be used in the rain. However, do not intentionally submerge it in water.
- If the light unit or parts become dirty with mud, etc., clean with a soft cloth which is moistened with mild soap. Never apply paint thinner, benzene or alcohol; damage will result.

**! LITHIUM-ION BATTERIES**

**Cautions on recharging**

- Avoid charging in direct sunlight or in a vehicle parked under direct sunlight, and make sure to charge only when the ambient temperature is between 41°F and 104 °F (5 and 40°C).
- Before charging, be sure that no dust or other foreign objects are attached to the USB plug.
- Do not subject the light to vibrations while charging.
- Once charging is complete, be sure to disconnect the USB plug.

**Cautions on use**

- Charging, discharging, and storing in high temperatures will cause the rechargeable battery to deteriorate faster.
- Do not place the light inside a vehicle or near a heater.
- If the illumination time is significantly reduced even after proper charging, the rechargeable battery may be nearing the end of its service life. Dispose of the battery as described in "Cautions for disposal".

**Cautions on storage**



Cool and dry storage is recommended. For long period storage, it is important to charge the battery 30 minutes every 6 months.

**Cautions for dispose**

When disposing of the light unit, remove the internal rechargeable battery and dispose of it according to local regulations.

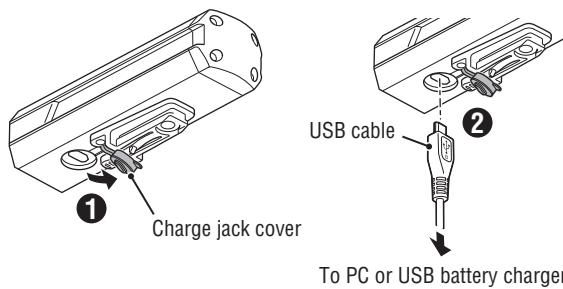
# 1 HOW TO CHARGE



Indicator		
	Steady red light	Charging
	Off	Charging is completed
Standard charging time		
Approx. <b>3-7h</b> (USB 2.0)		

1. Connect the light unit to your PC or a commercial USB battery charger using the USB cable. (Fig 1 ①-②). The indicator turns on and charging starts.
  - \* When your PC is in sleep state, the unit cannot be charged.
  - \* Use a USB battery charger of 500 mAh (USB2.0) or more. The light can be fast-charged with a high capacity USB battery charger.
2. Once charging is complete, be sure to disconnect the USB plug.
  - \* Charging and lighting times are approximate values, and will vary by environmental and use conditions.

# 2 HOW TO MOUNT TO A BICYCLE

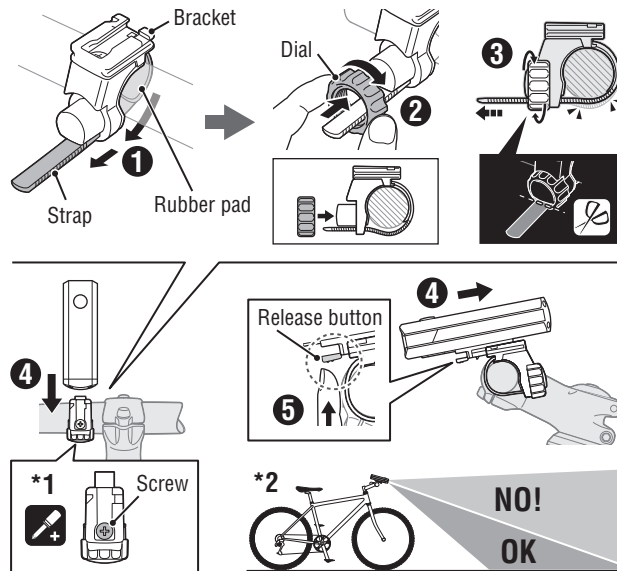

1. Mount the bracket to the handlebar. (Fig 2 ①-③)
  2. Insert the light unit into the bracket until it clicks, and adjust the beam angle. (④) (\*2)
  3. To remove the light unit, pull it forward while pressing down on the release button (⑤).
- \* To readjust the beam angle, loosen the dial and/or the screw enough to move the bracket, and firmly tighten them after adjustment.

**CAUTION!**

- Be sure to tighten the dial by hand. If tightened too hard with a tool, the screw thread may be stripped.
- Check the dial and screw (\*1) on the bracket periodically, to monitor for any loosening.
- Round off the cut edge of the bracket strap to prevent injury.

# 3 SWITCH OPERATION

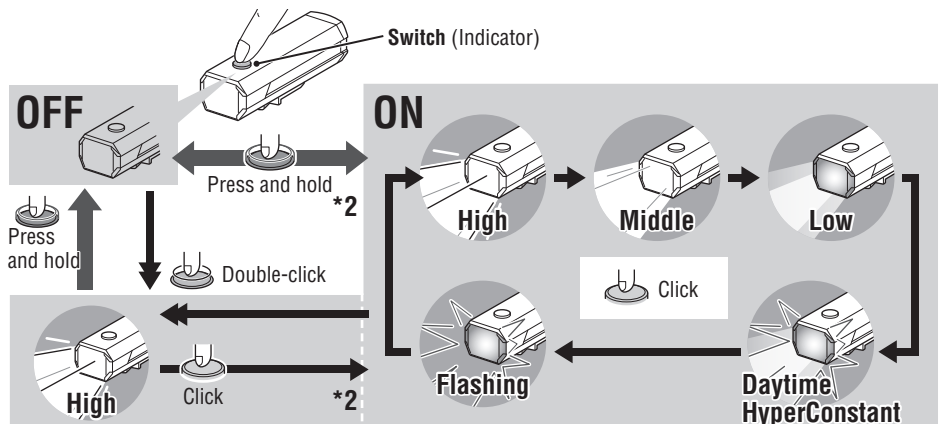

\*2 When turning the light on, it lights up in the mode that was used last time. (Mode memory function)

**Remaining battery capacity:**

When the switch is illuminated in red, there is little remaining battery power.

Indicator	Constant blue light	Constant yellow light	Constant red light
	Approx. 50% or more	Approx. 50-30%	Less than Approx. 30%
Remaining battery power			

## SPARE/OPTIONAL PARTS

### 5338827N

FlexTight™ bracket  
(H-34N)

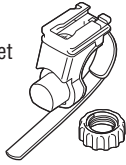

### 5342440

Center fork bracket  
(CFB-100)

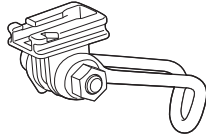

### 5341831N

Helmet mount

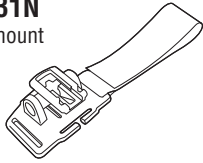

### 5342730

USB cable  
(MICRO USB)

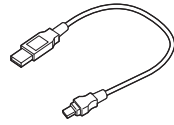

## SPECIFICATIONS

Light source	High-intensity LED x 1	
Battery	Li-ion 3.7 v 2500 mAh	
Charge	Micro USB plug	
Operating time	High	: Approx. 1.5 hours
	Middle	: Approx. 2 hours
	Low	: Approx. 4 hours
	Daytime HyperConstant	: Approx. 4 hours
	Flashing	: Approx. 30 hours
	* Average runtime at 20°C.	
Standard charging time	Approx. 3 – 7 hours	
Temperature range	Charging	: 41°F – 104°F (5°C – 40°C)
	Operating	: 14°F – 104°F (-10°C – 40°C)
Recharge/discharge number of times	About 300 times (until the rated capacity drops to 70%)	
	Dimensions/weight	1-17/64" x 4-1/64" x 1-19/64" (32 x 102 x 33 mm) / 4.8 oz (136 g)
	* The specifications and design are subject to change without notice.	

## LIMITED WARRANTY

### 2-year Warranty: Light unit only (excludes battery deterioration)

CatEye products are warranted to be free of defects from materials and workmanship for a period of 2 years from original purchase. If the product fails to work during normal use, CatEye will repair or replace the defect at no charge. Service must be performed by CatEye or an authorized retailer. To return the product, pack it carefully and enclose the warranty certificate (proof of purchase) with instruction for repair. Please write or type your name and address clearly on the warranty certificate. Insurance, handling and transportation charges to CatEye shall be borne by person desiring service. For UK and REPUBLIC OF IRELAND consumers, please return to the place of purchase. This does not affect your statutory rights.

## CAT EYE CO., LTD.

2-8-25, Kuwazu, Higashi Sumiyoshi-ku,  
Osaka 546-0041 Japan  
Attn: CATEYE Customer Service Section  
Phone : (06)6719-6863  
Fax : (06)6719-6033  
E-mail : support@cateye.co.jp  
URL : <https://www.cateye.com>

### [For US Customers]

CATEYE AMERICA, INC.  
2825 Wilderness Place Suite 1200, Boulder CO  
80301-5494 USA  
Phone : 303.443.4595 Toll Free : 800.5.CATEYE  
Fax : 303.473.0006 E-mail : [service@cateye.com](mailto:service@cateye.com)