

DENNIS 3-DEURS KAST

3-TÜRIG SCHRANK - ARMOIRE 3 PORTES - 3-DOORS WARDROBE

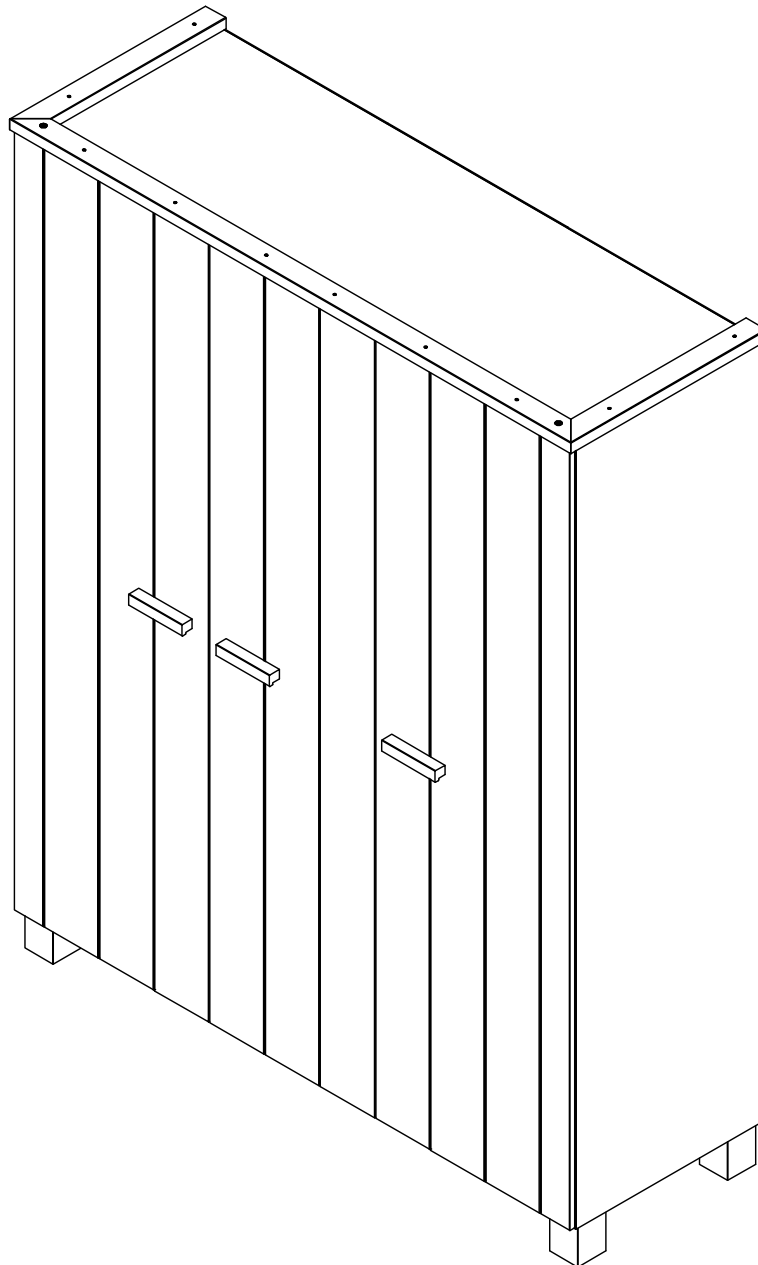

WOOD MADE BY

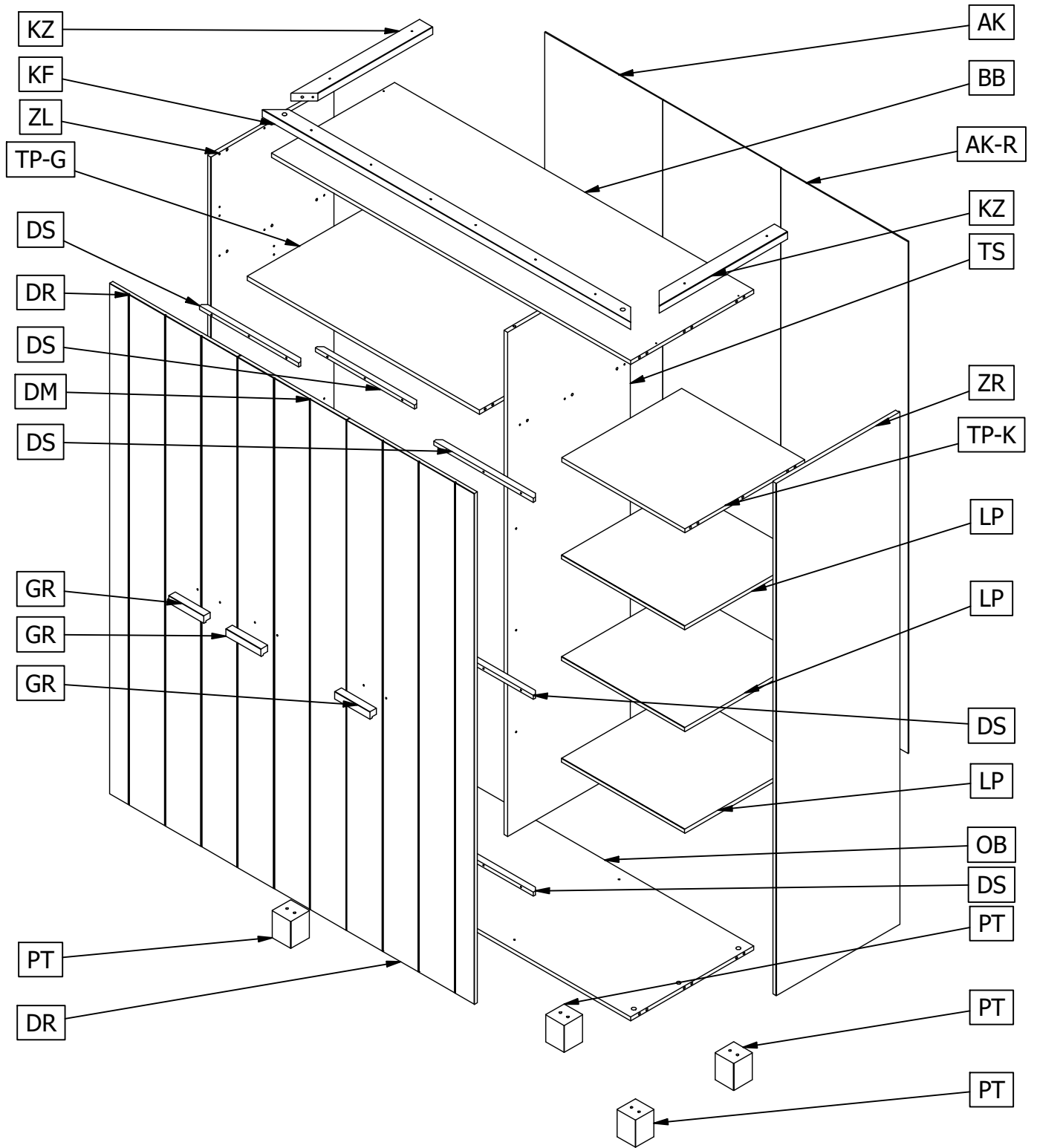

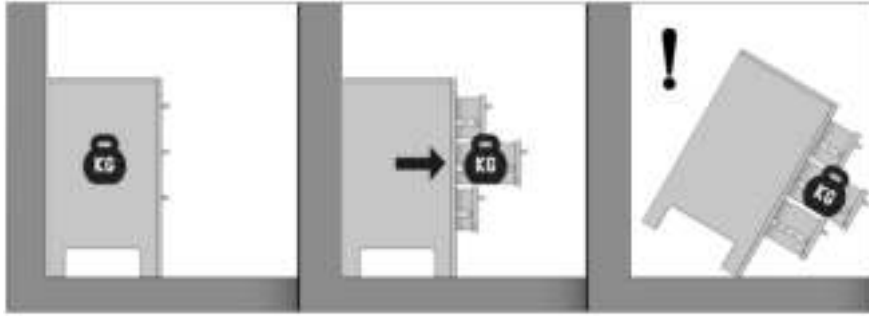

Nederlands

WAARSCHUWING.

Voorkom dat dit meubel omvalt. Meubels die omvallen kunnen ernstig of levensbedreigend letsel veroorzaken. Het meegeleverde kantelbeslag dient daarom BESLIST te worden gebruikt om het meubel te bevestigen aan de muur.

Sta niet toe dat kinderen klimmen op lades, deuren of planken.
Plaats zware voorwerpen altijd onderin.
Zet zware voorwerpen nooit op het meubel.

Norsk

ADVARSEL.

Unngå at dette møbelet faller. Møbler som faller kan forårsake alvorlige eller livstruende skader. Det medleverte beslaget skal derfor ABSOLUTT brukes for å feste møbelet til veggen.

Ikke tillat at barn klatrer på skuffer, dører eller planker.
Plasser tunge objekter alltid nederst.
Sett aldri tunge objekter på møbelet.

Deutsch

WARNHINWEIS.

Verhindern Sie, dass dieses Möbelstück umstürzt. Möbel, die umfallen, können schwere oder lebensbedrohliche Verletzungen verursachen. Zur Befestigung des Möbelstücks an der Wand sollte daher UNBEDINGT die mitgelieferte Kippsicherung verwendet werden.

Erlauben Sie Kindern nicht, auf Schubladen, Türen oder Regale zu klettern.
Stellen Sie schwere Gegenstände nur unten in das Möbelstück.
Stellen Sie niemals schwere Gegenstände auf das Möbelstück.

Français

ATTENTION.

Évitez que le meuble ne bascule. Les meubles qui basculent peuvent être à l'origine de blessures graves ou mortelles. La fixation anti-basculement fournie avec le meuble doit OBLIGATOIREMENT être utilisée pour fixer celui-ci au mur.

Ne laissez pas les enfants grimper sur les tiroirs, portes ou étagères.
Placez toujours les objets lourds dans le bas du meuble.
Ne placez jamais les objets lourds sur le meuble.

English

CAUTION.

Prevent this furniture from falling over. Falling furniture could cause severe or life-threatening injuries. Therefore, the included tip-over restraint HAS to be used to secure the furniture to the wall.

Do not allow children to climb on the drawers, doors or shelves.
Always place heavy objects at the bottom.
Never place heavy objects on top of the furniture.

Svenska

VARNING.

Förhindra att denna möbel välter. Möbler som välter kan orsaka allvarliga eller livshotande skador. Det medföljande tipskyddet MÅSTE därför användas för att förankra möbelen i väggen.

Låt inte barn klättra på lådor, dörrar eller hyllor.
Placera alltid tunga föremål längst ned.
Ställ aldrig tunga föremål på möbelen.

Polski

UWAGA.

Zabezpiecz meble przed przewróceniem. Przewrócenie się mebli może spowodować poważne lub śmiertelne obrażenia ciała. Dlatego załączone ograniczniki przechyli ZDECYDOWANIE powinny zostać wykorzystane do przymocowania mebla do ściany.



















Nie pozwalaj dzieciom wspinać się na szuflady, drzwiczki lub półki.
Zawsze umieszczaj ciężkie przedmioty w dolnej części.
Nigdy nie stawiaj na meblu ciężkich przedmiotów.

Español

ADVERTENCIA.

Evite que este mueble se caiga. Los muebles que se caen pueden ocasionar lesiones graves o potencialmente mortales. Por lo tanto, el herraje abatible suministrado debe utilizarse SIN LUGAR A DUDAS para fijar el mueble a la pared.

No permita que los niños se suban a los cajones, las puertas o los estantes.
Los objetos pesados siempre deben colocarse en la parte inferior.
Nunca coloque objetos pesados sobre el mueble.

30	Ø15mm	AC000102 	6	Ø35 0mm	AC000423 
30	24mm	AC000103 	9	2MM	AC000448 
6	3x15mm	AC000201 	38	8x35mm	AC000601 
10	3.5x40mm	AC000203 	1	L=987	AC000902 
20	4x16mm	AC000204 	1	Safety	AC000356 
33	3.5x35mm	AC000219 	1	Glue	AC000607 
50	Ø1.4x25mm	AC000316 	28	Ø14	AC000369-* 
2	15x22mm	AC000335 			
12	Ø5MM	AC000349 			
6	19x14mm	AC000371 			
3	Ø35 9mm	AC000418 			

1

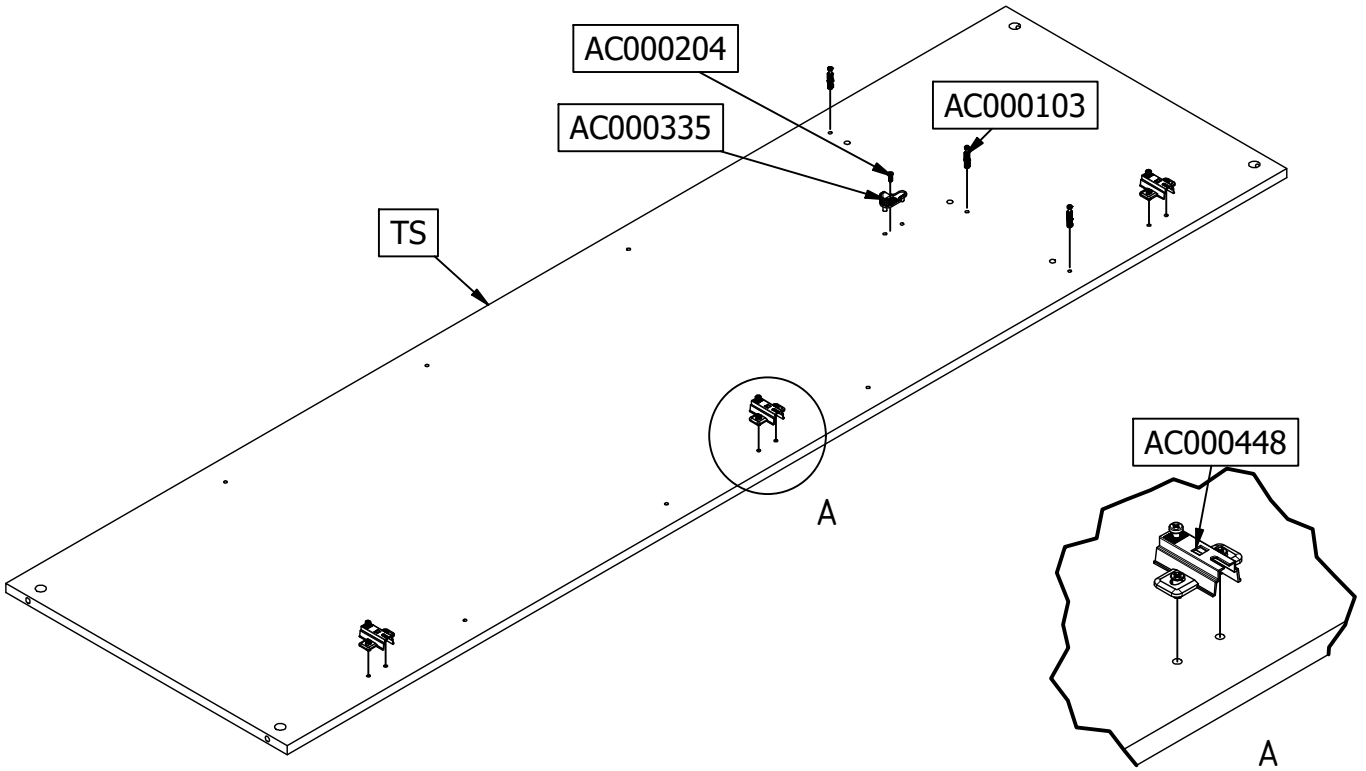
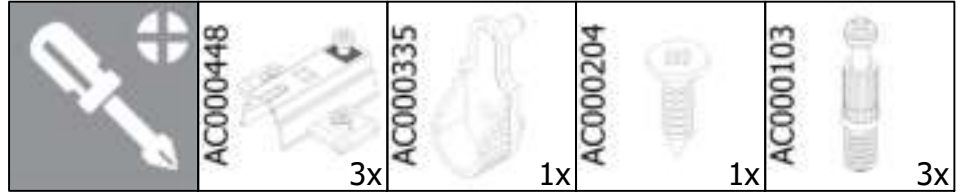

2

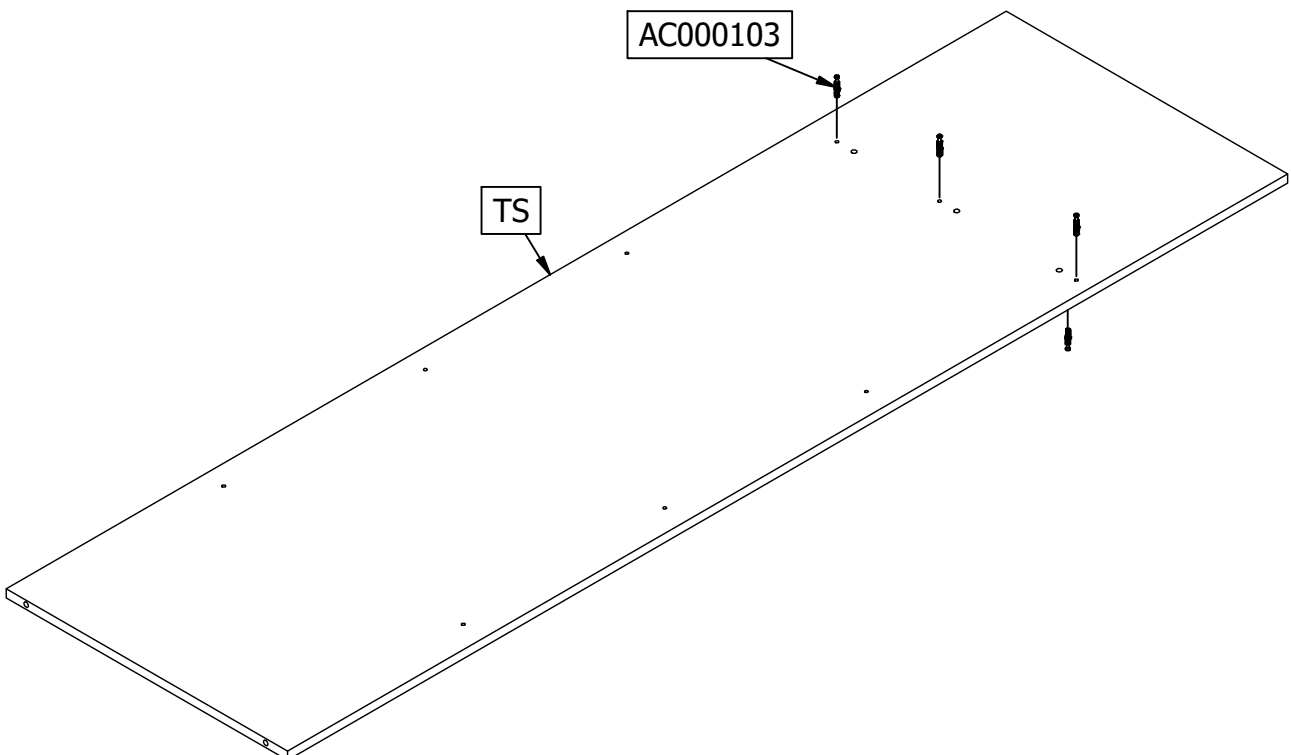
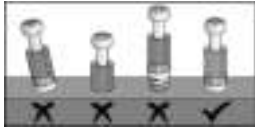

3

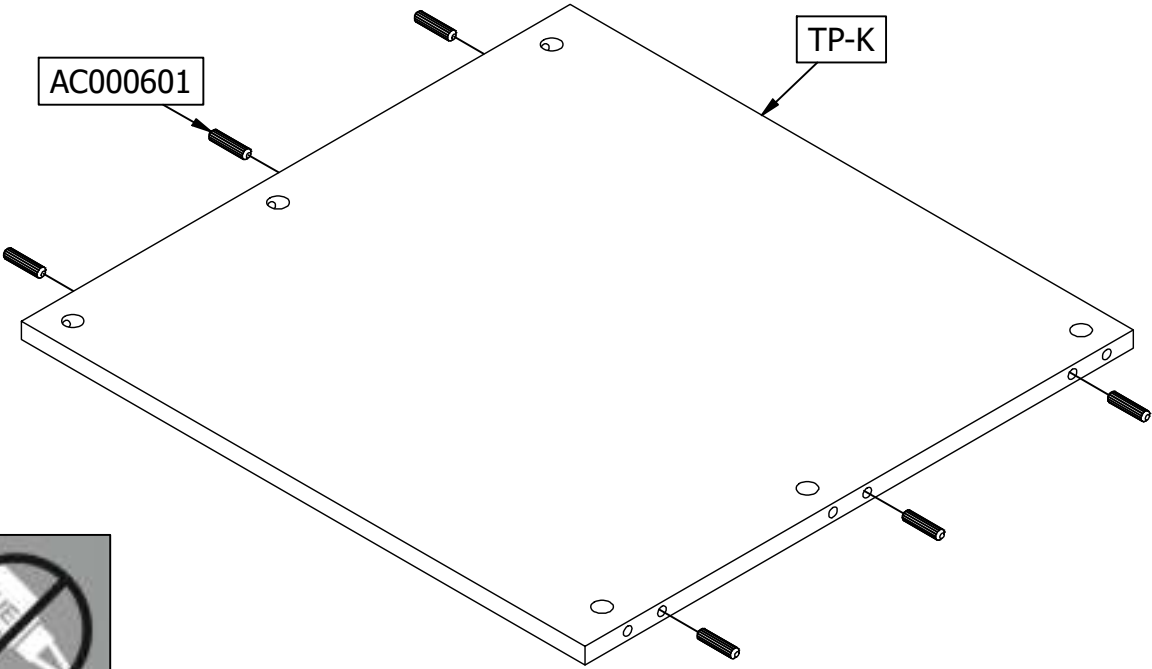
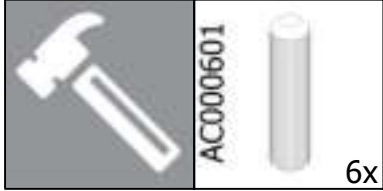

4

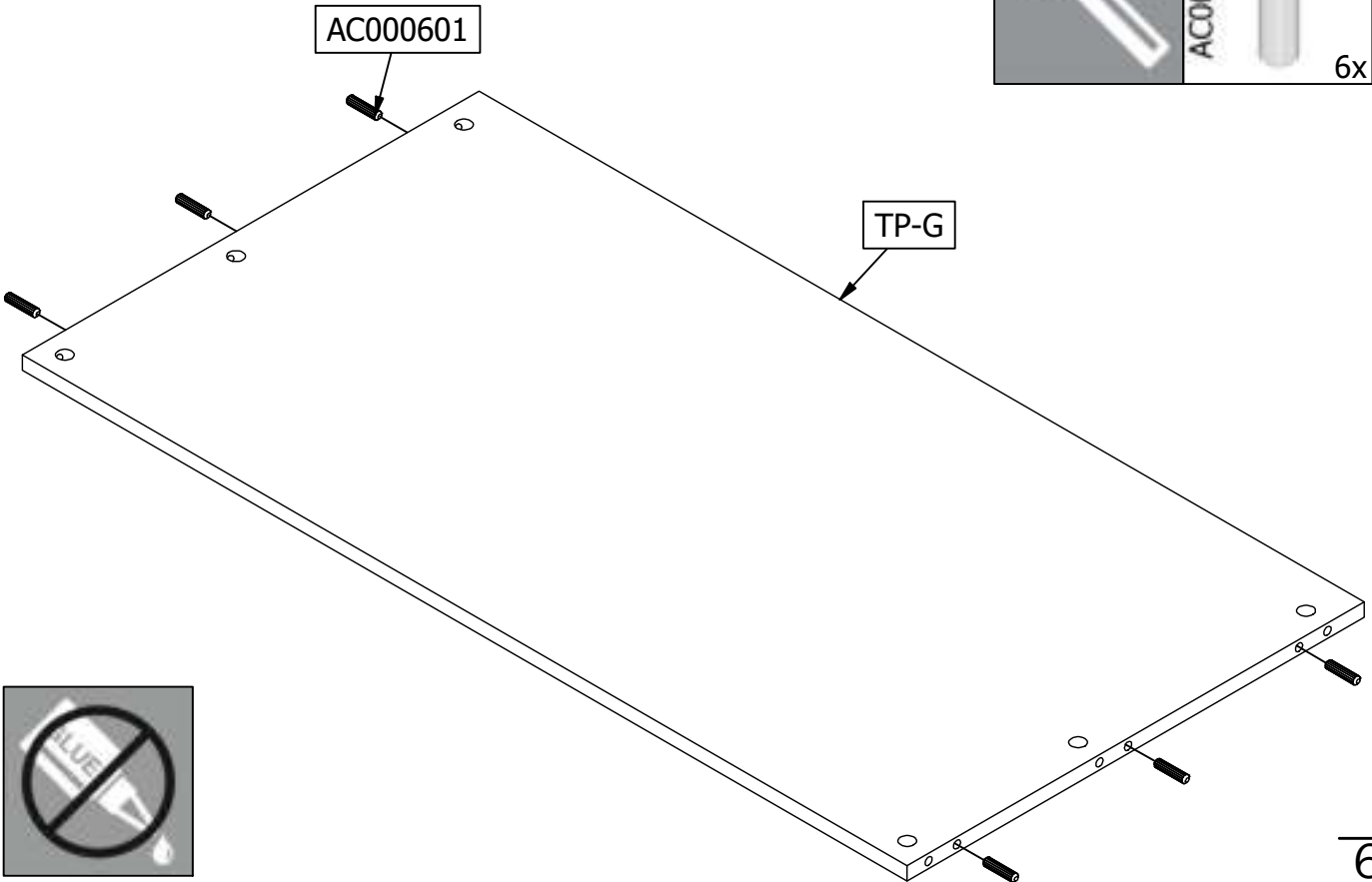
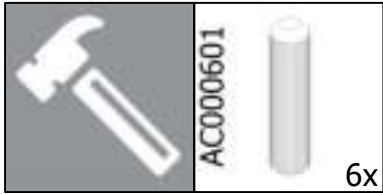

5

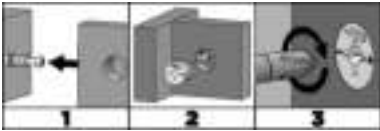
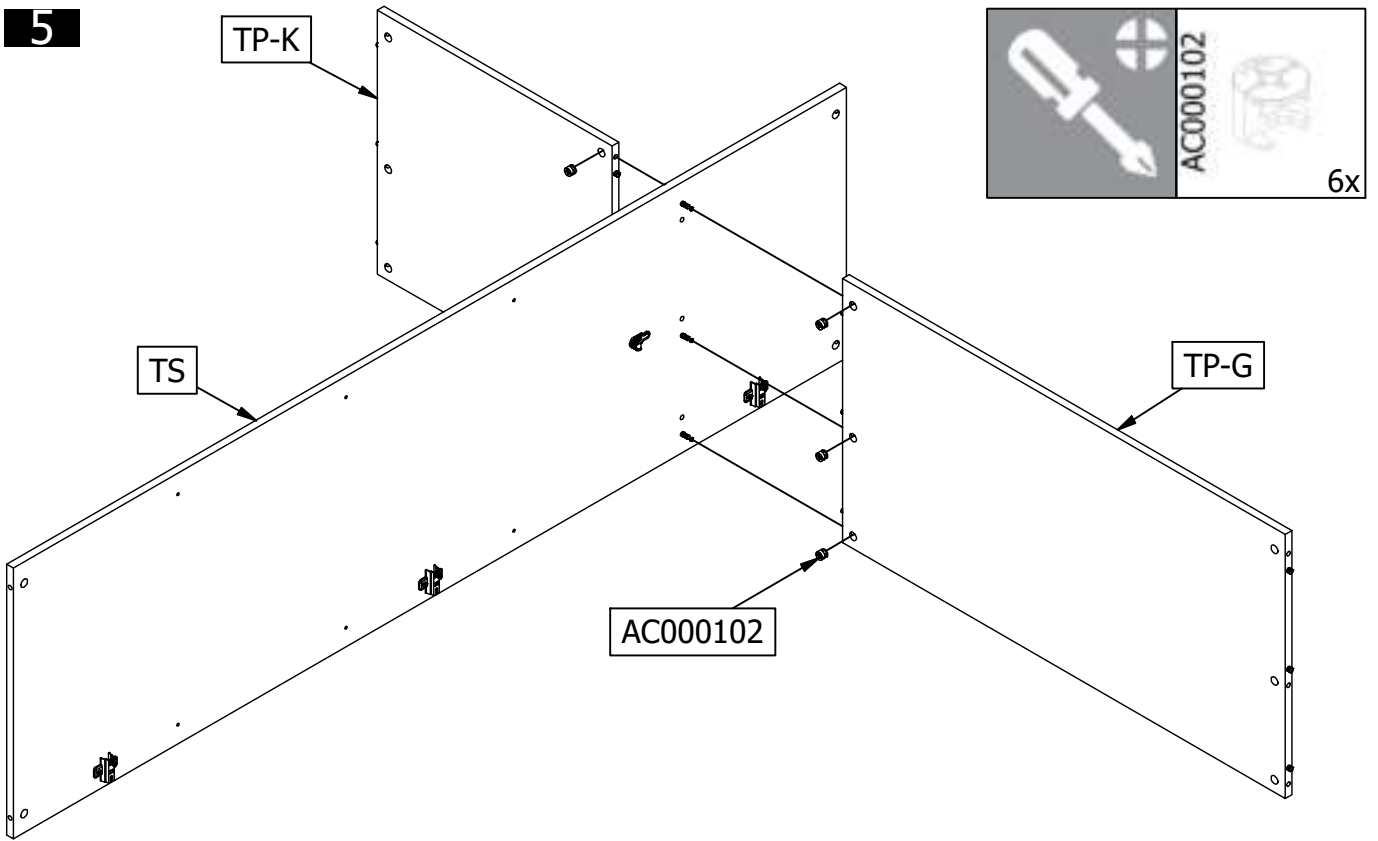

6

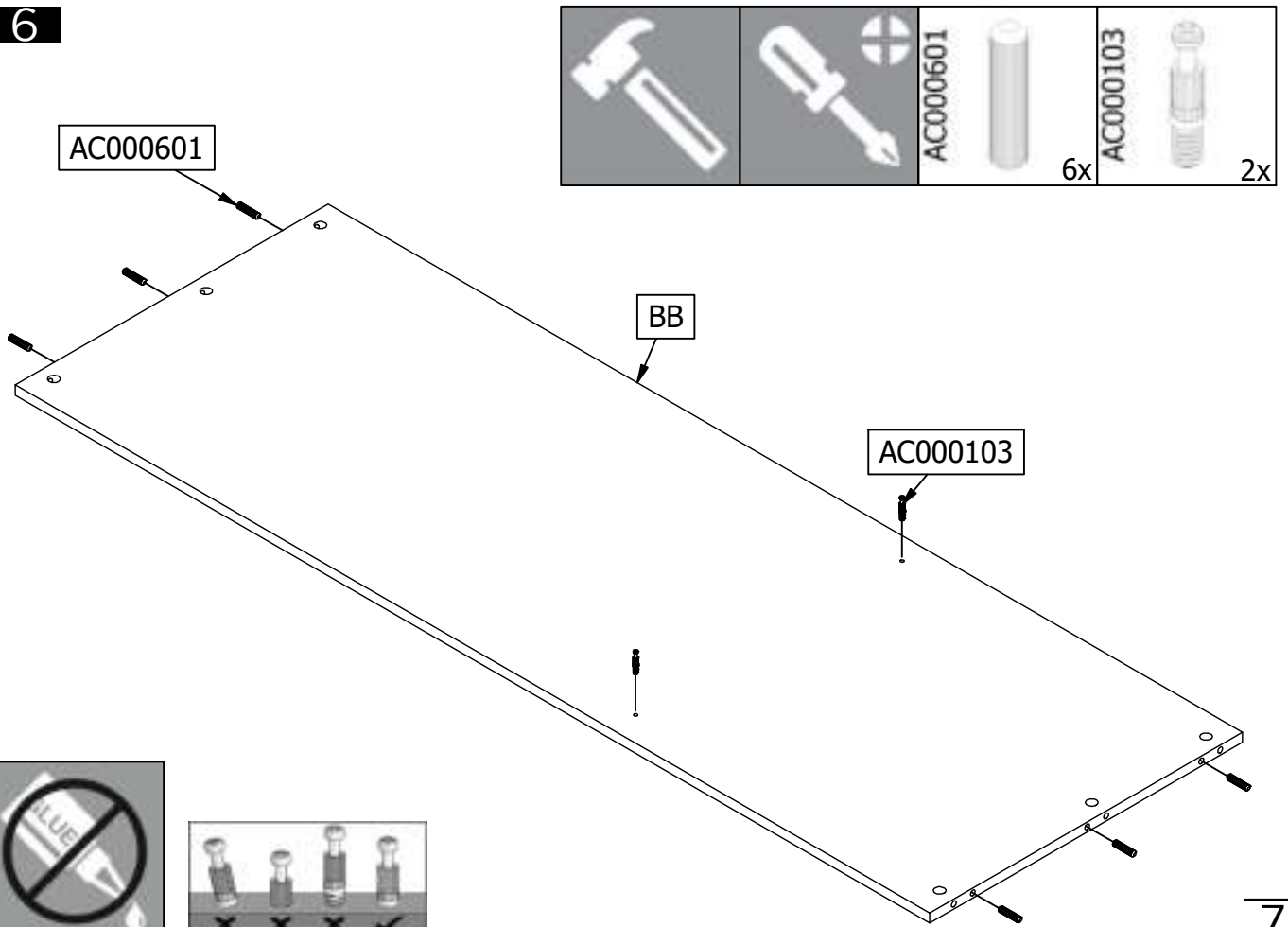

7

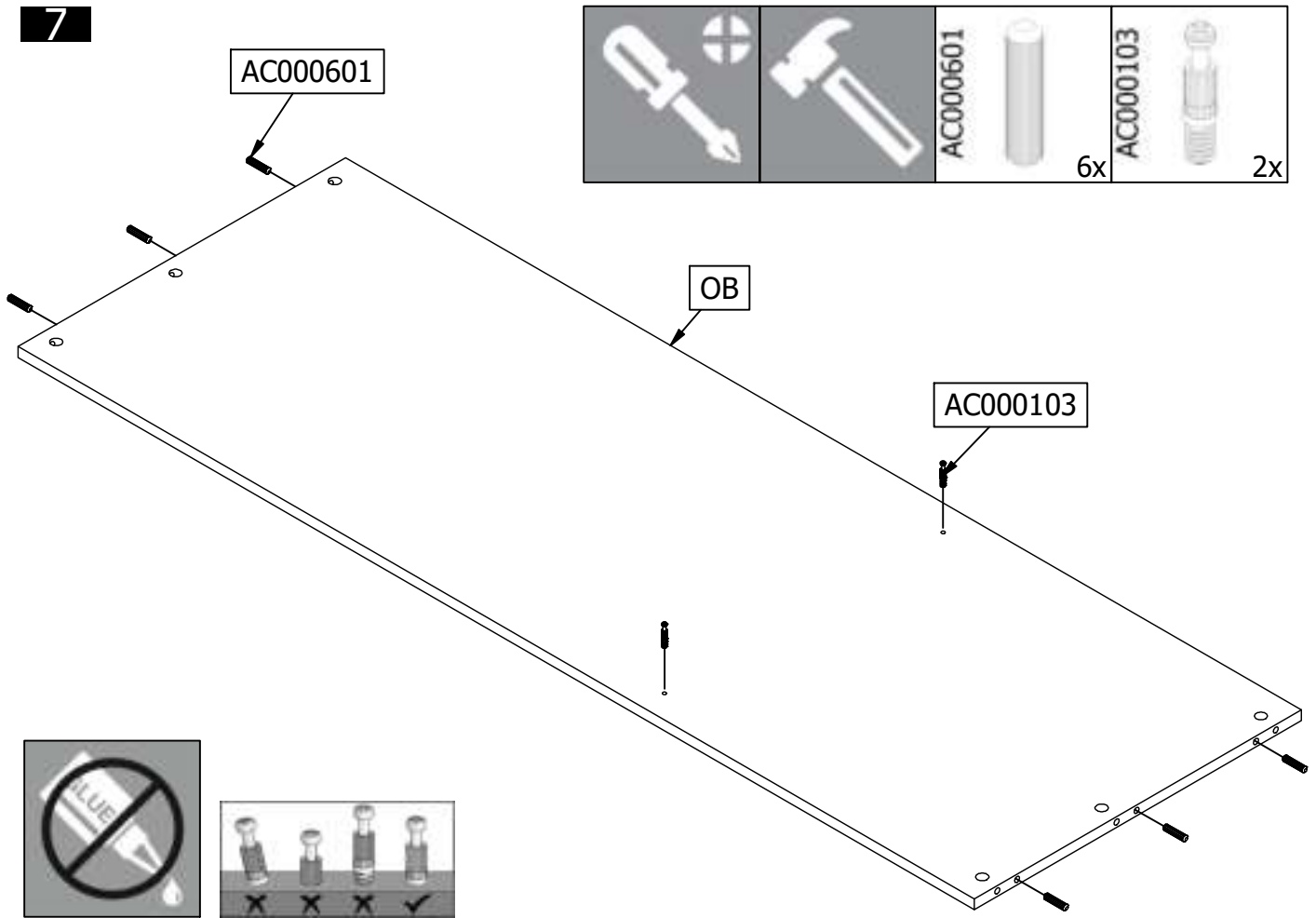

8

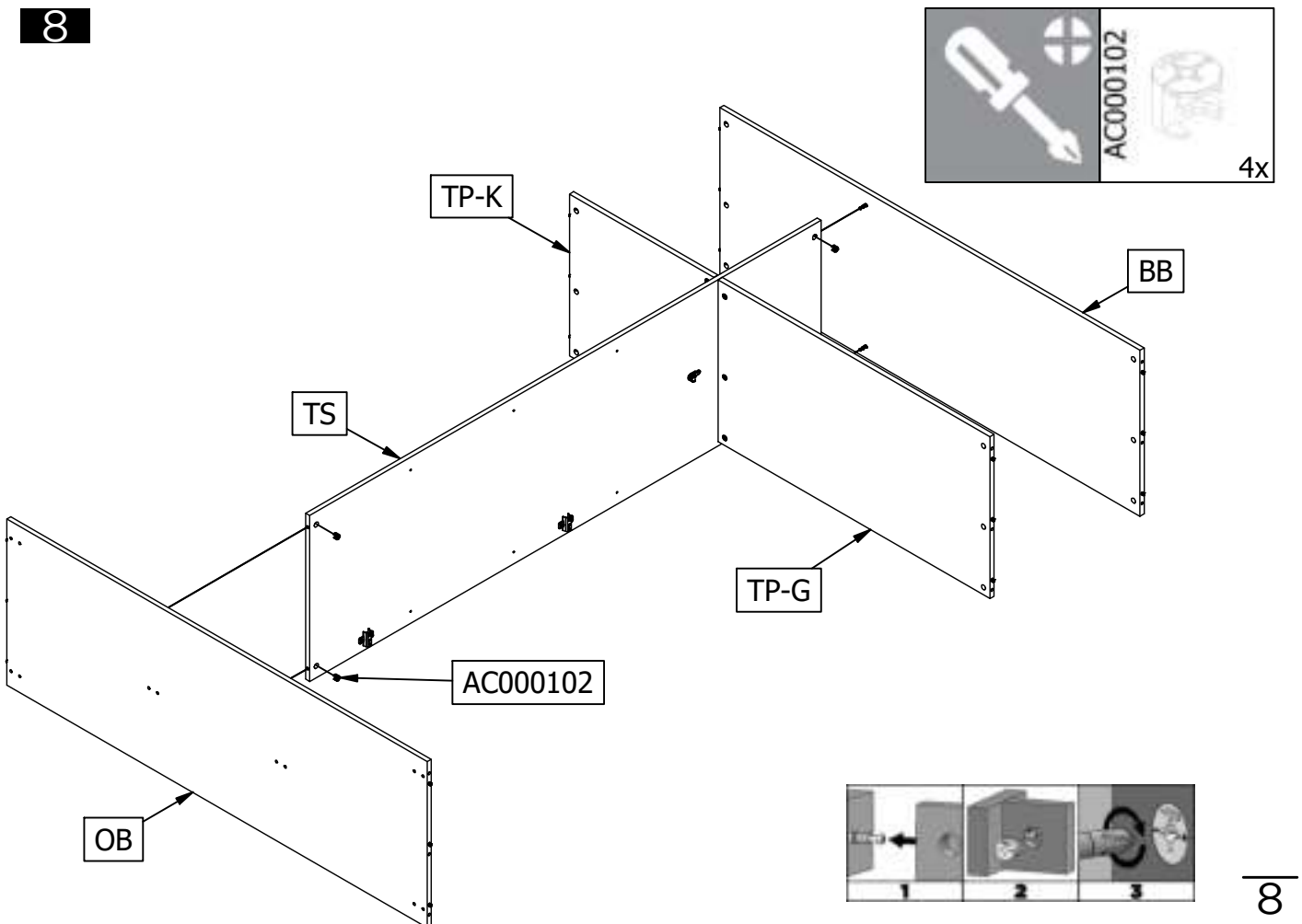

9

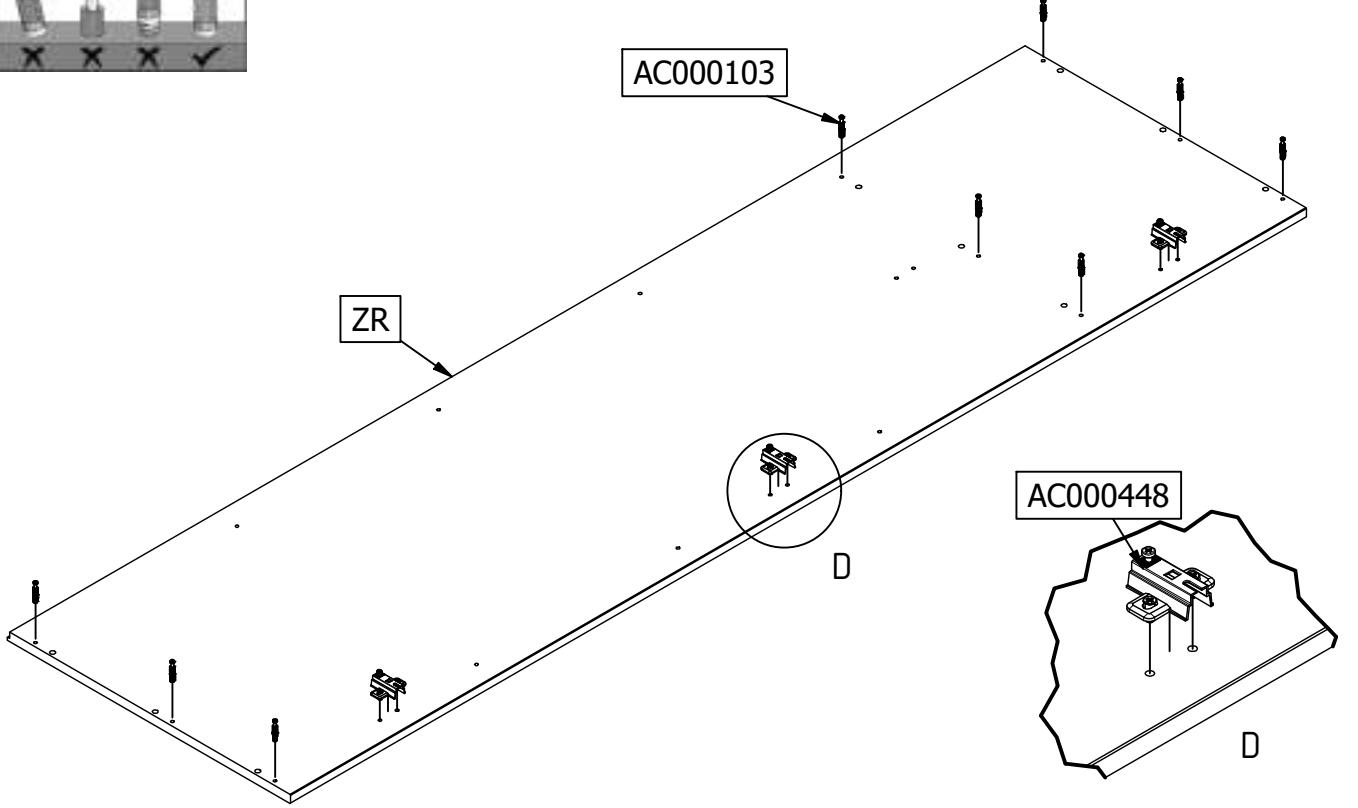
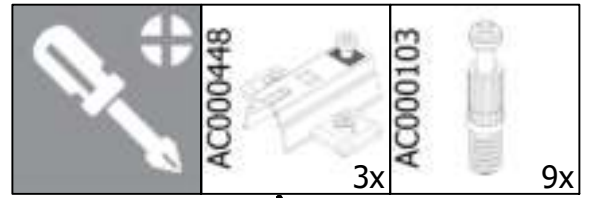
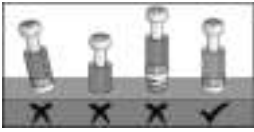

10

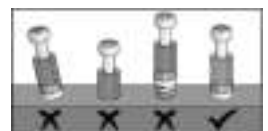
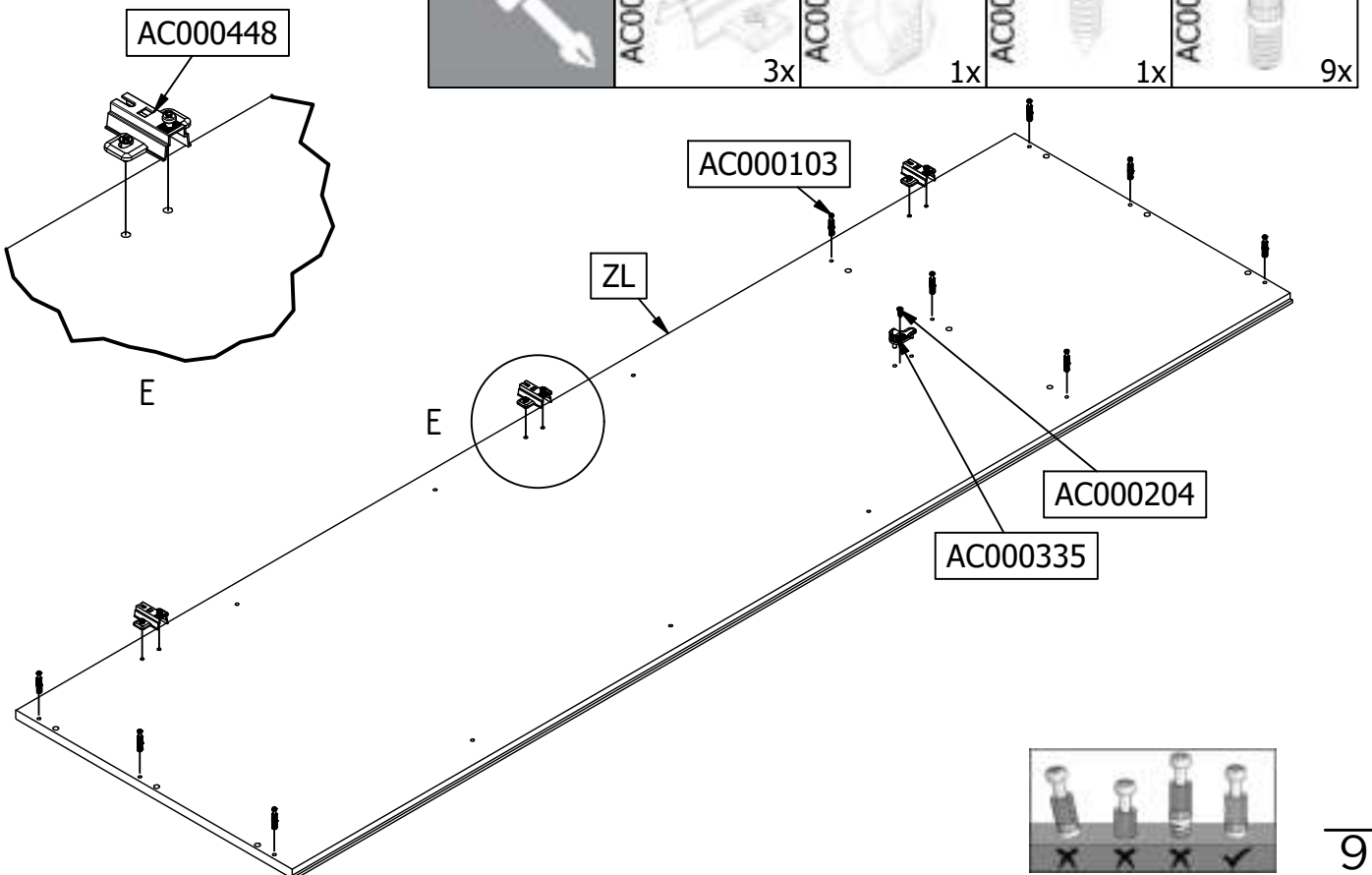
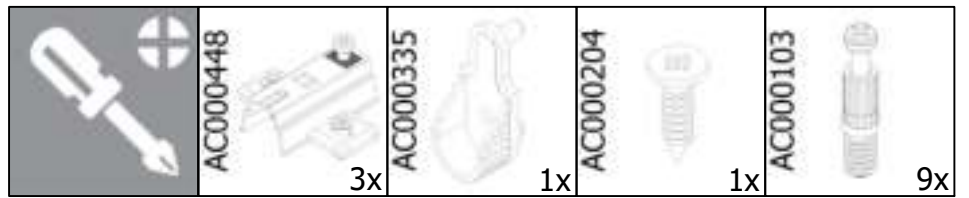

11

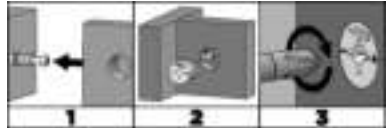
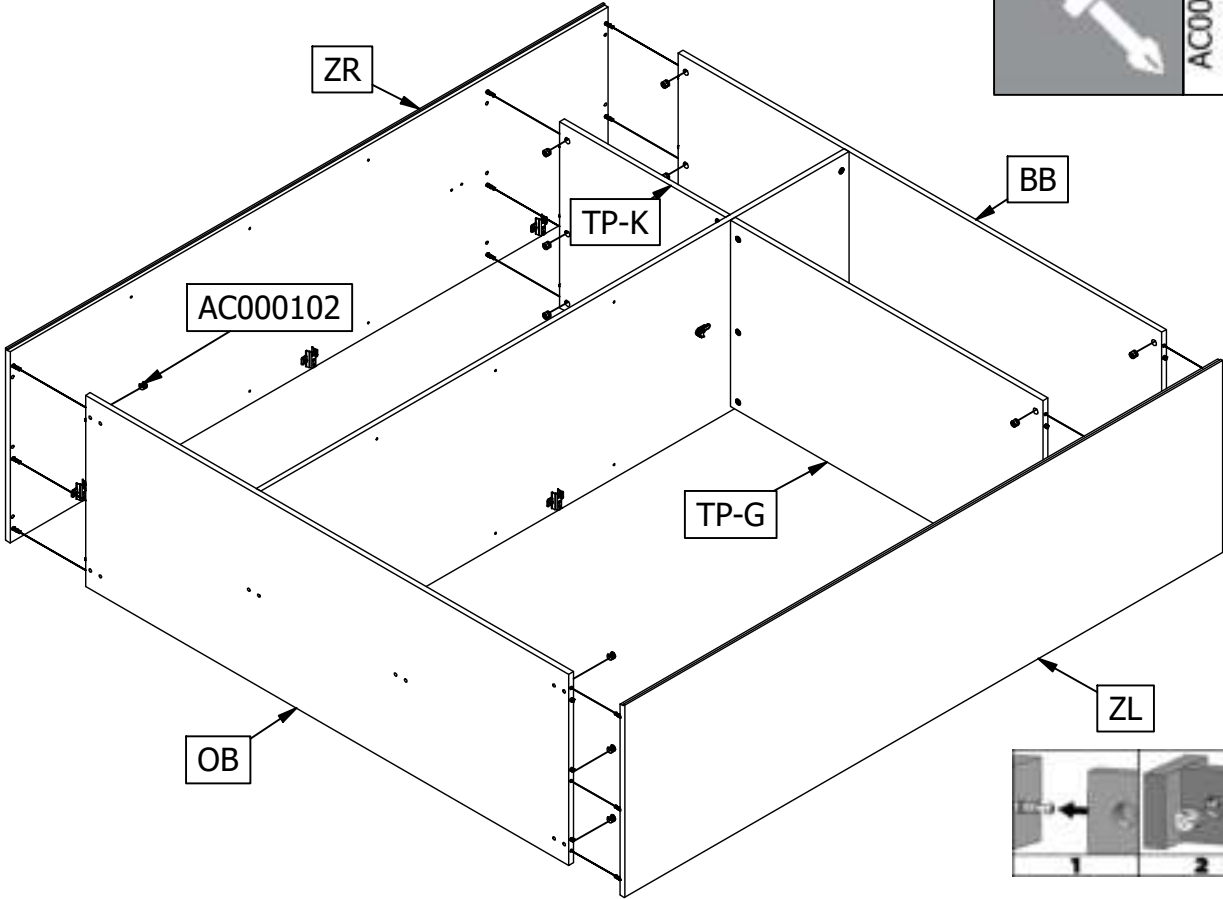
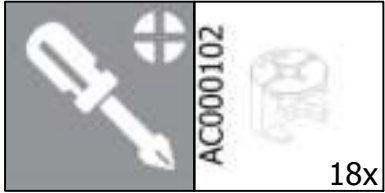

12

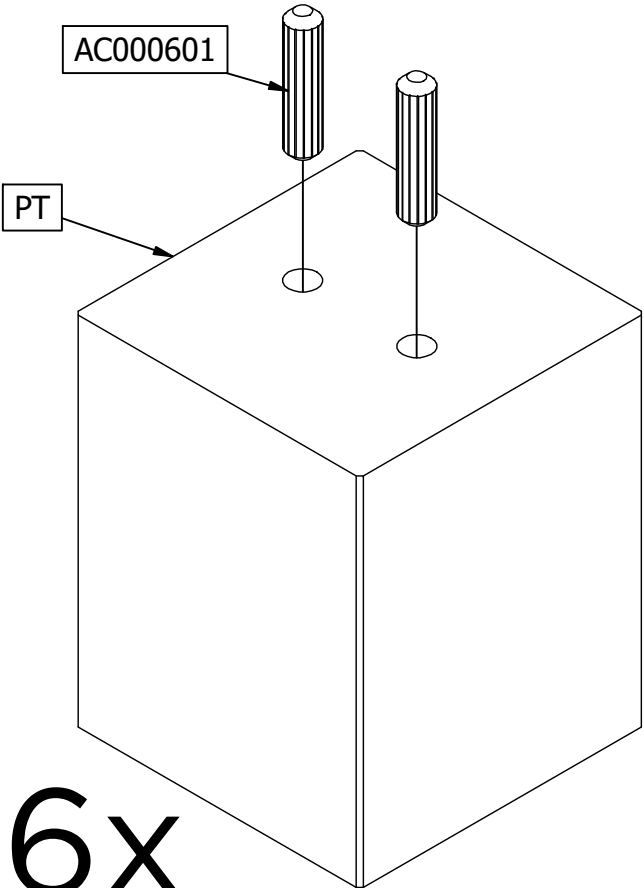
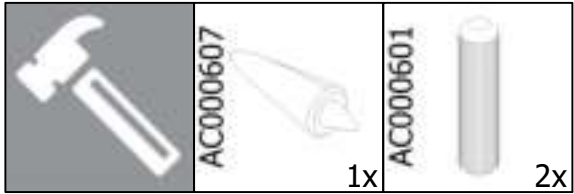

Het gebruik van een klein beetje houtlijm is noodzakelijk voor een goede verbinding
 Für eine stabile Verbindung ist ein bisschen Holzleim erforderlich
 Un peu de colle à bois est nécessaire pour un assemblage solide
 The use of a little wood glue is necessary for proper connection

6x

13

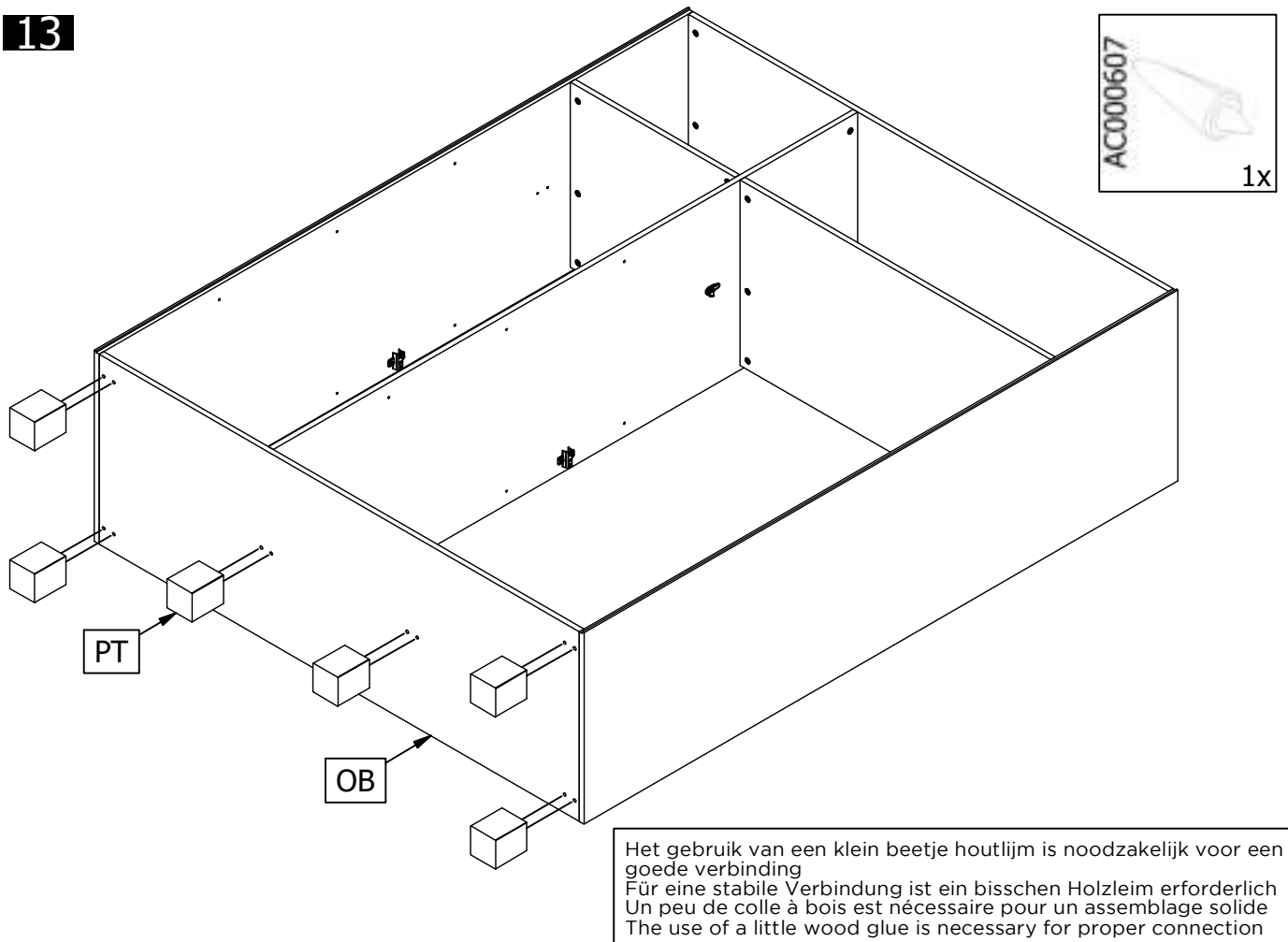

14

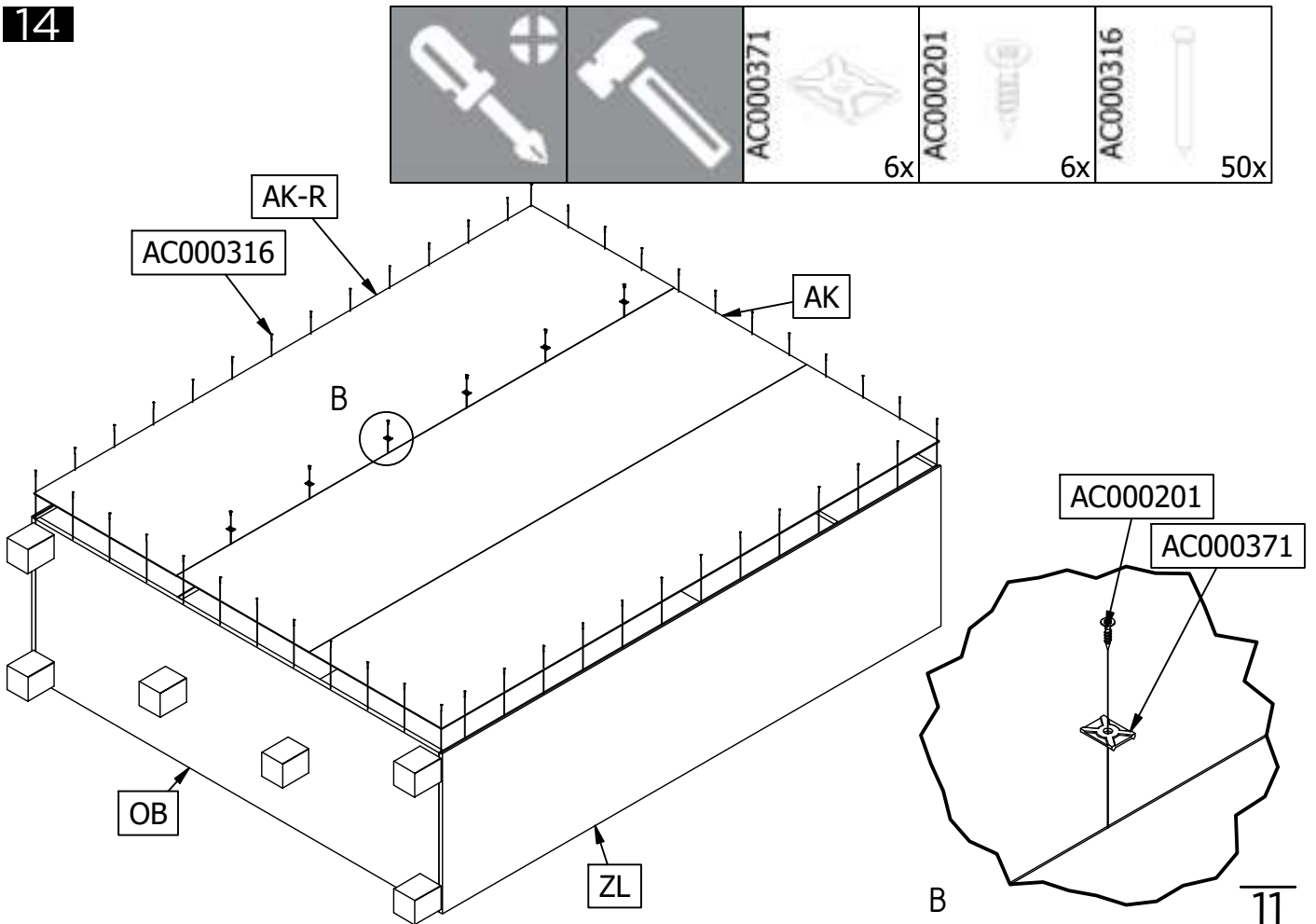

15

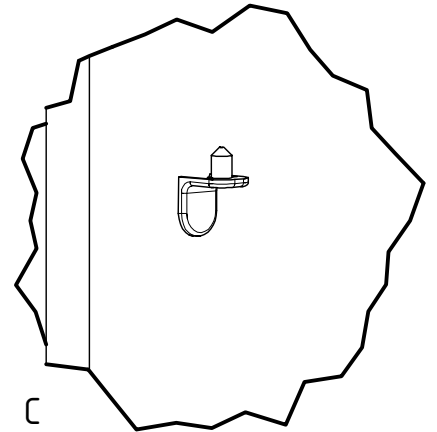
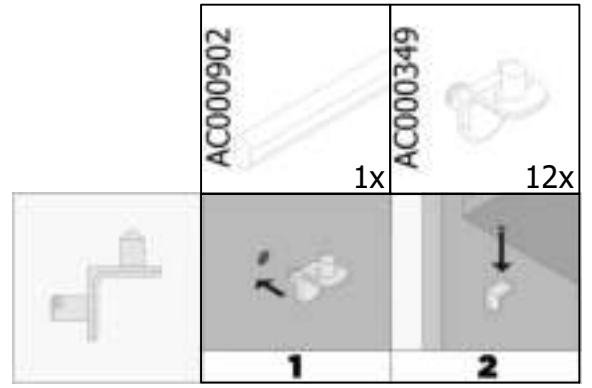
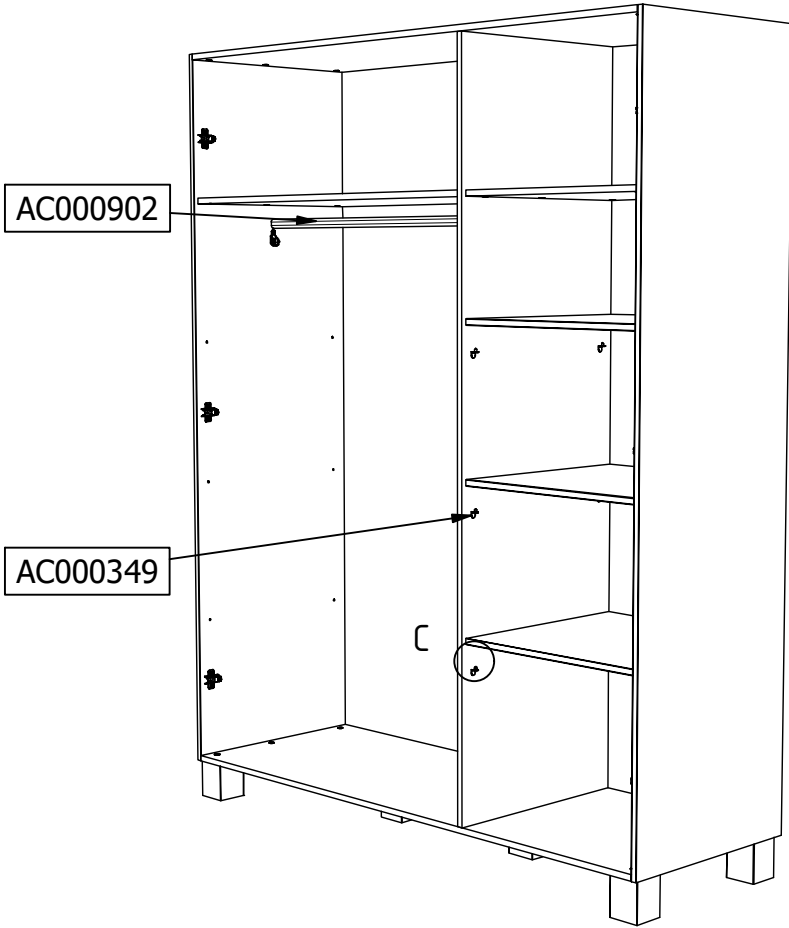

16

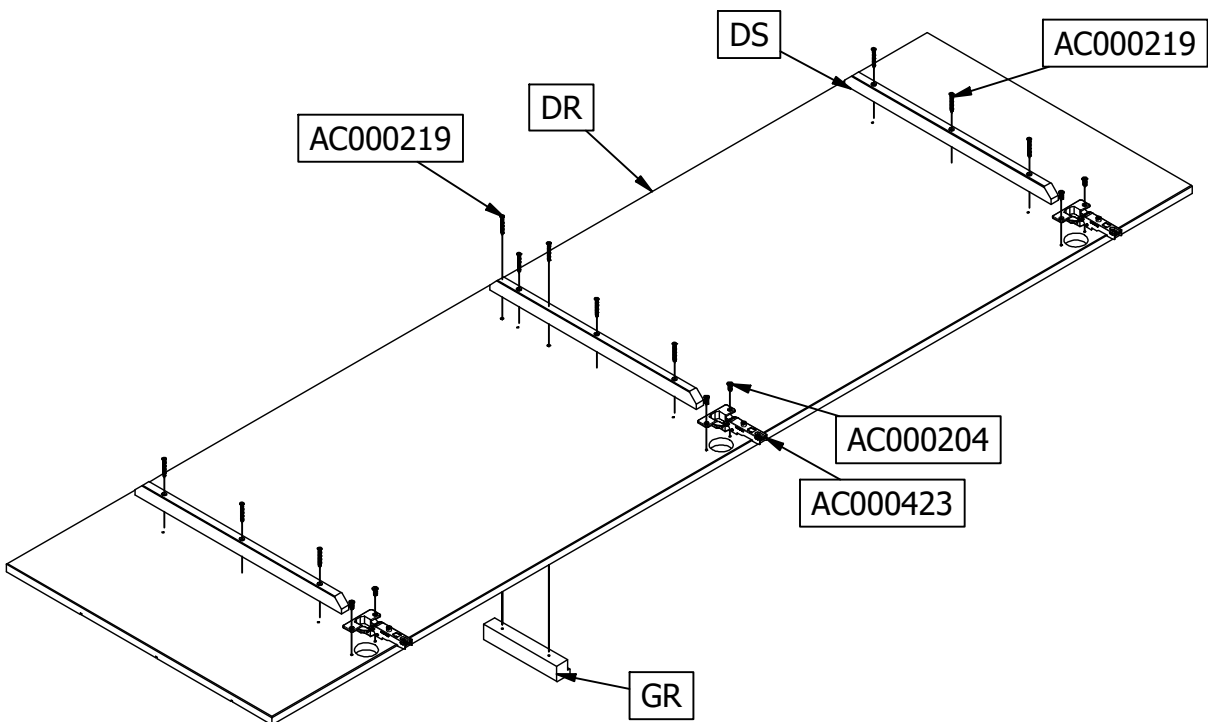
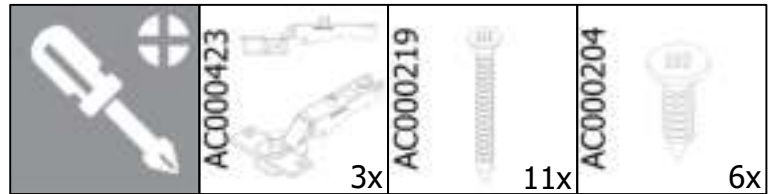

17

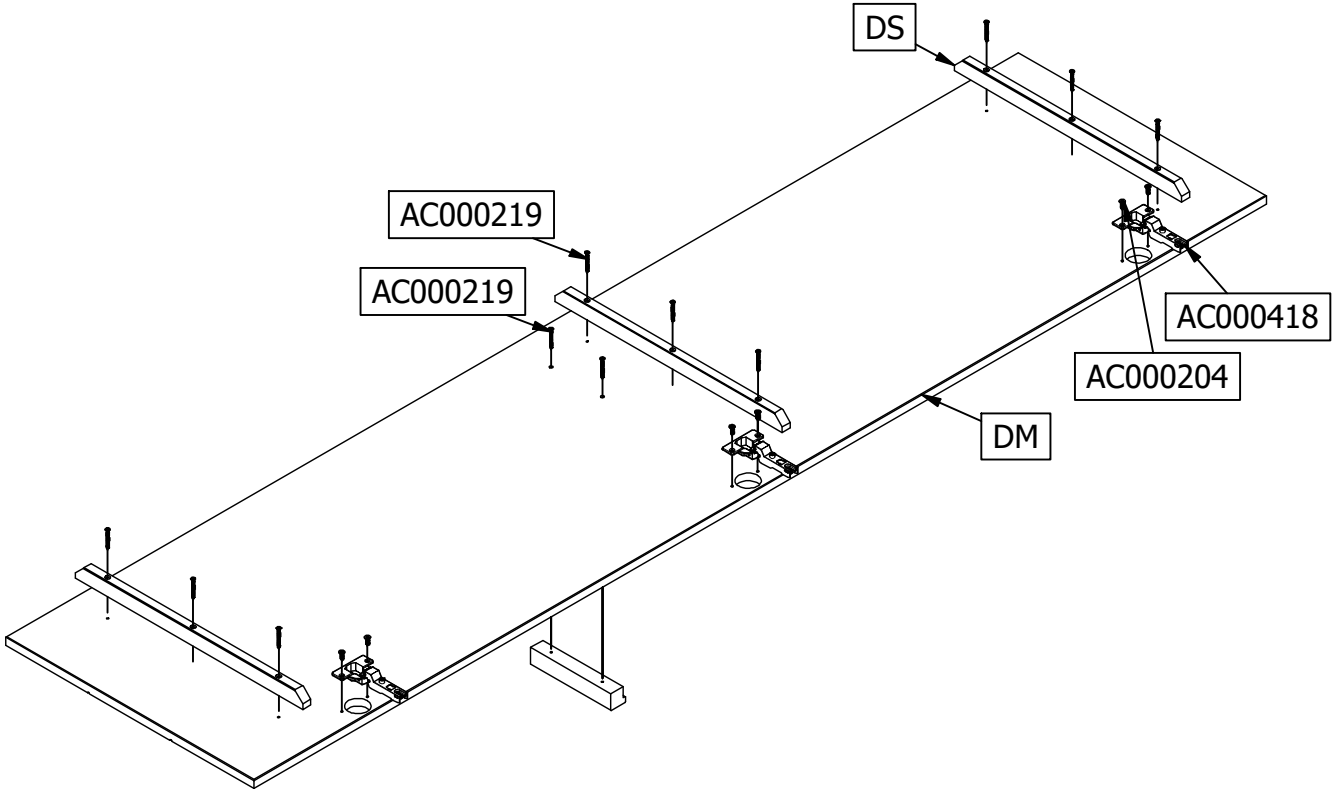
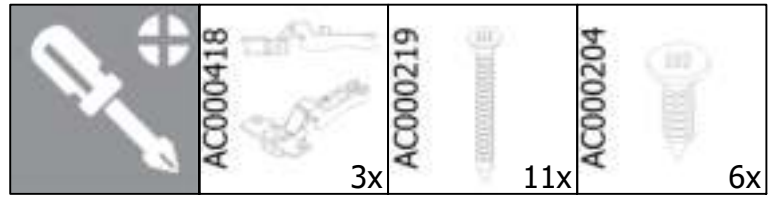

18

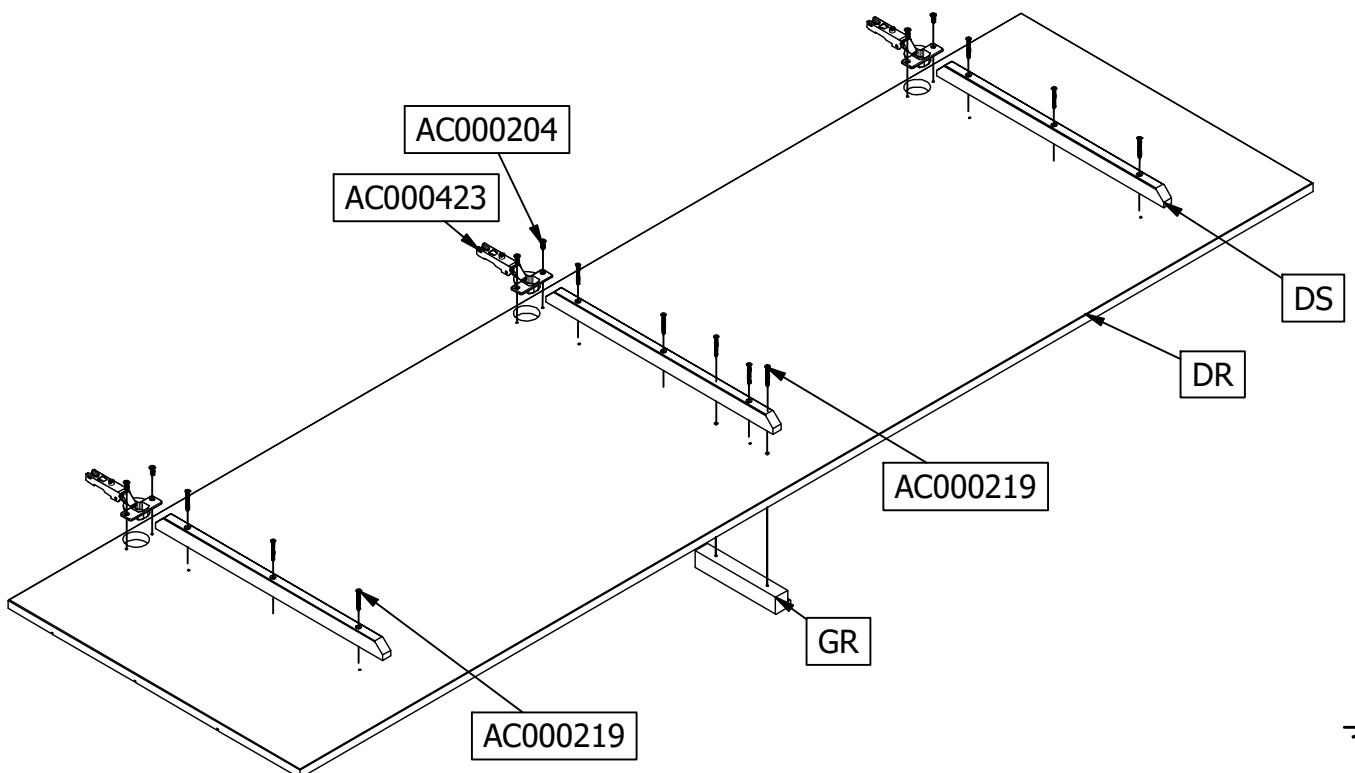
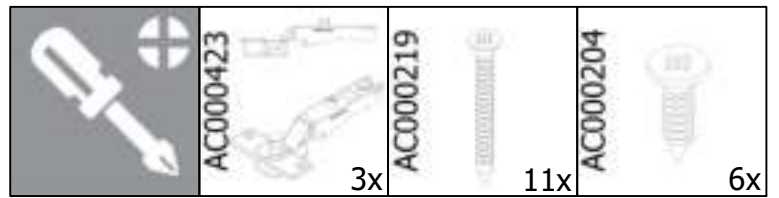

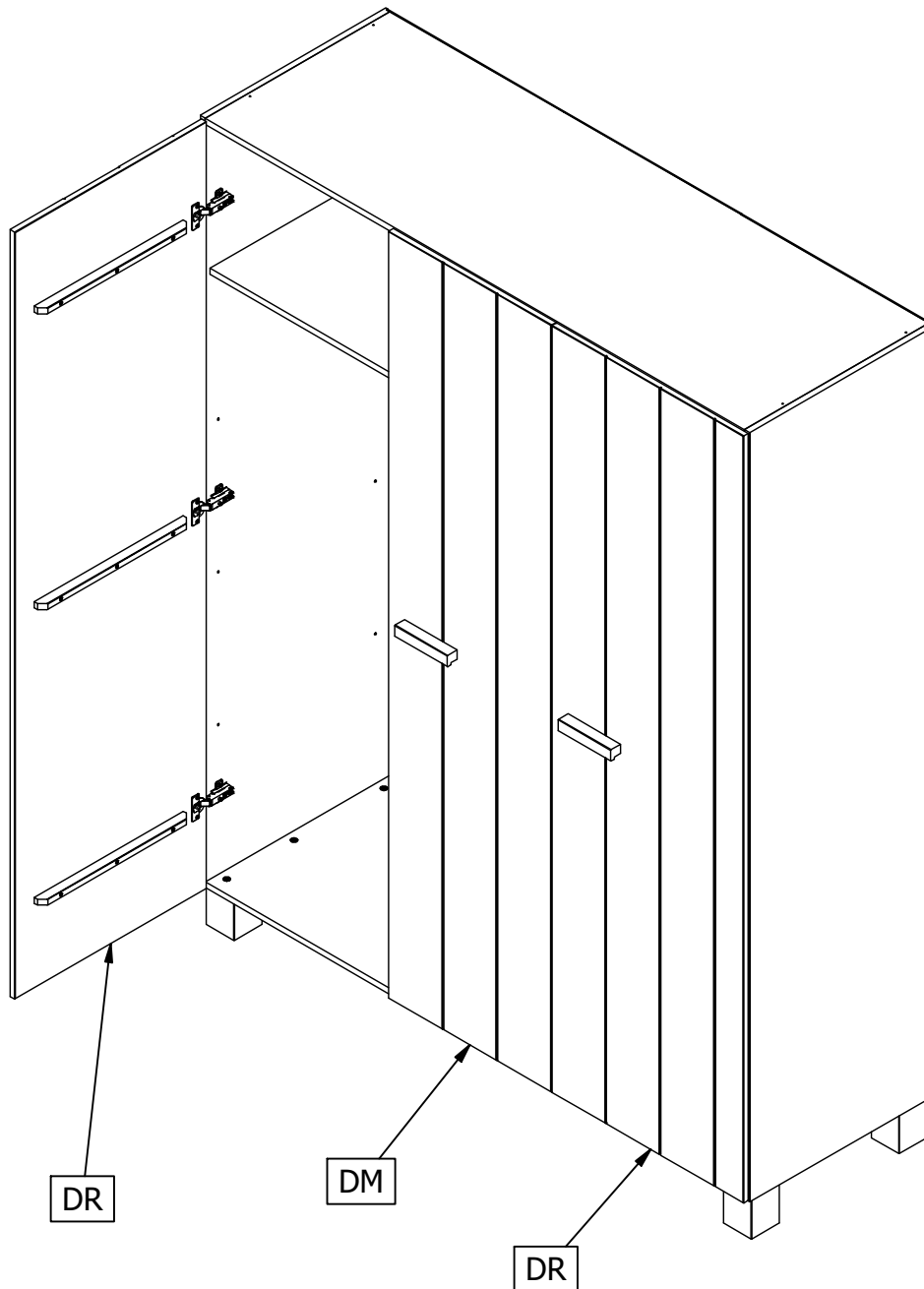

- A. Deze schroef gebruiken wanneer u de kieren tussen de deuren en beide zijden groter of kleiner wilt hebben.
 B. Door deze schroeven iets los te draaien kunt u de scharnierplaatjes verstellen zodat de deuren hoger of lager bevestigd kunnen worden.
 C. Met deze schroef draait u de deur vast.

- A. Diese Schraube benutzen, wenn der Spalt Zwischen der Tür und den Seiten größer oder kleiner sein soll.
 B. Wenn Sie diese Schrauben ein wenig lösen, können Sie die Scharnierplatten verstellen, um so die Tür höher oder niedriger zu befestigen.
 C. Mit dieser Schraube befestigen Sie die Tür.

- A. Utilisez cette vis, si vous voulez agrandir ou réduire la fente entre la porte et les deux côtés de l'armoire.
 B. En dévissant ces vis quelque peu, vous pouvez régler les charnières pour accrocher ensuite la porte plus haute ou plus basse.
 C. Fixez la porte à l'aide de cette vis.

- A. Adjusting this screw will position doors horizontally (changes gap between doors)
 B. By releasing this screw the position of mounting plates of the hinges can be repositioned so that vertical position of doors can be adjusted (higher//lower)
 C. This screw fixes the door.

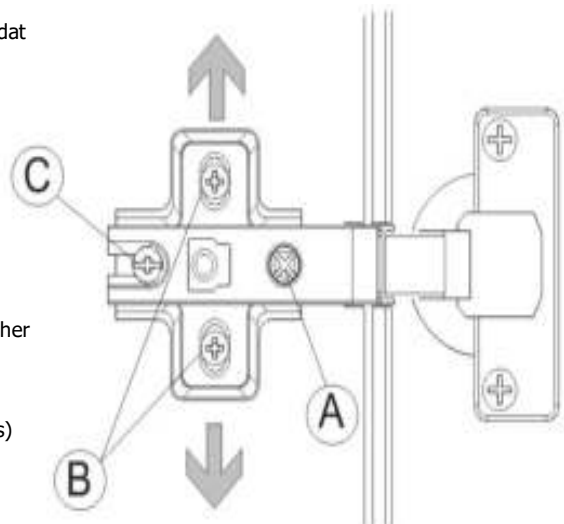

20

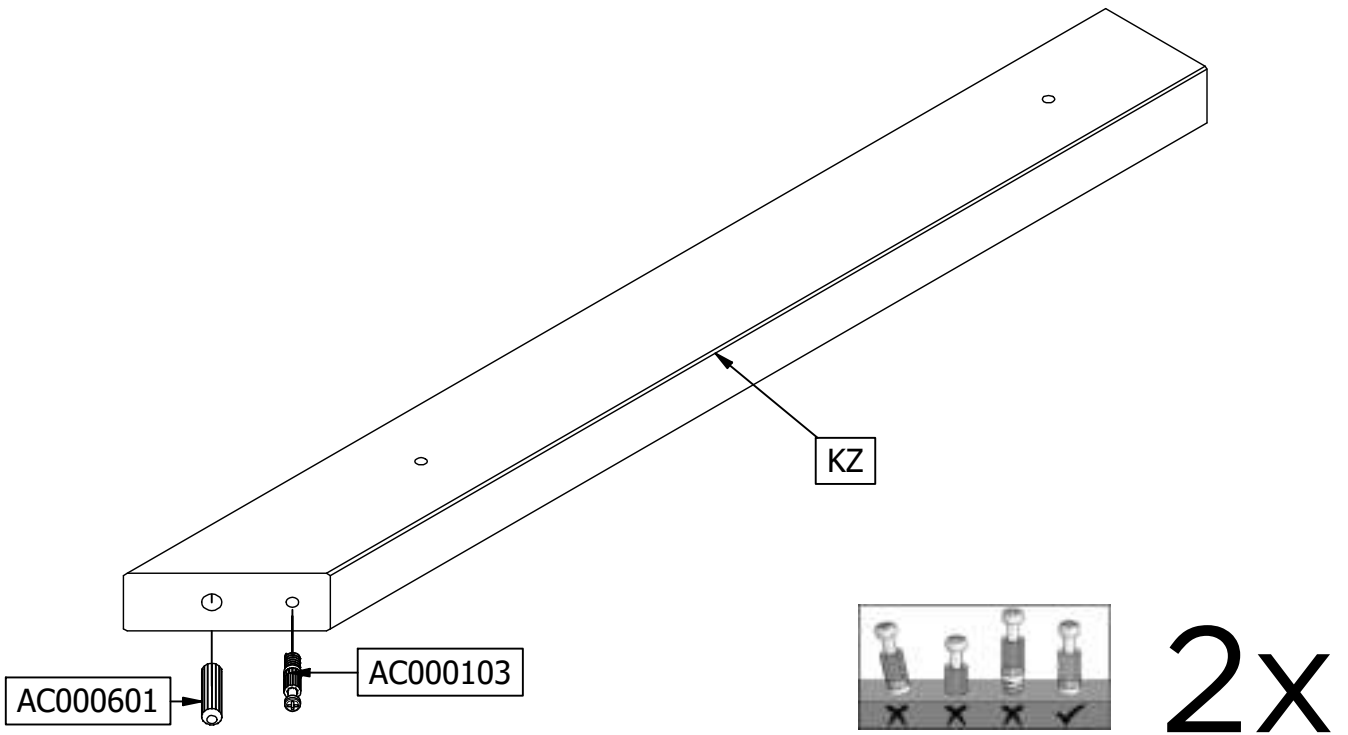

21

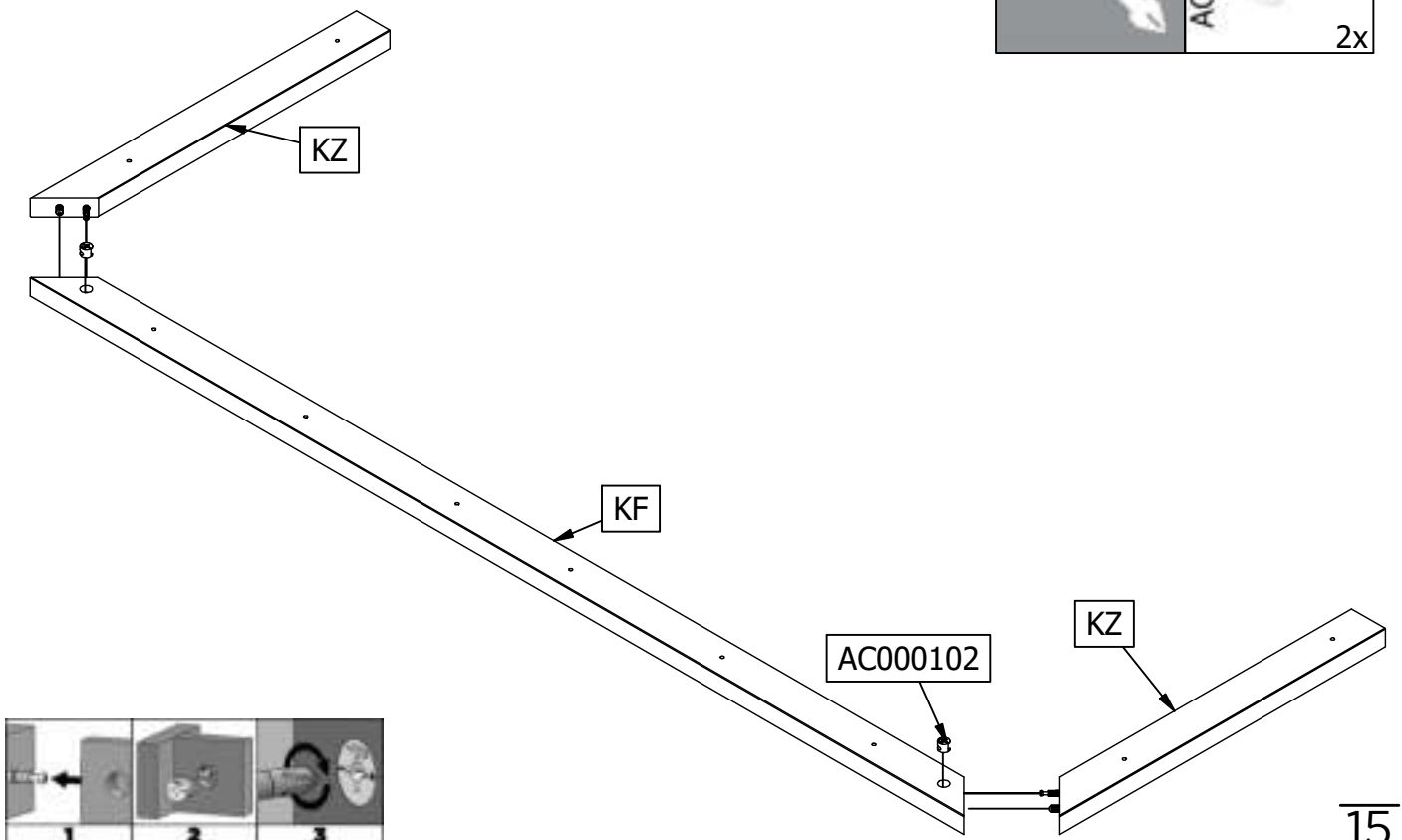
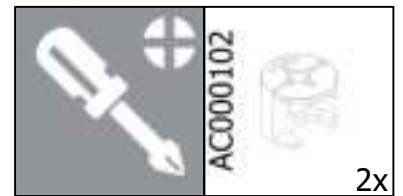

22

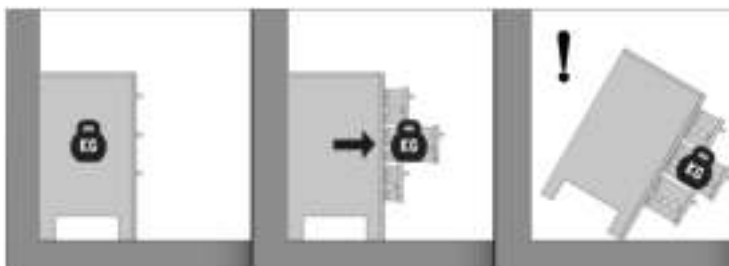
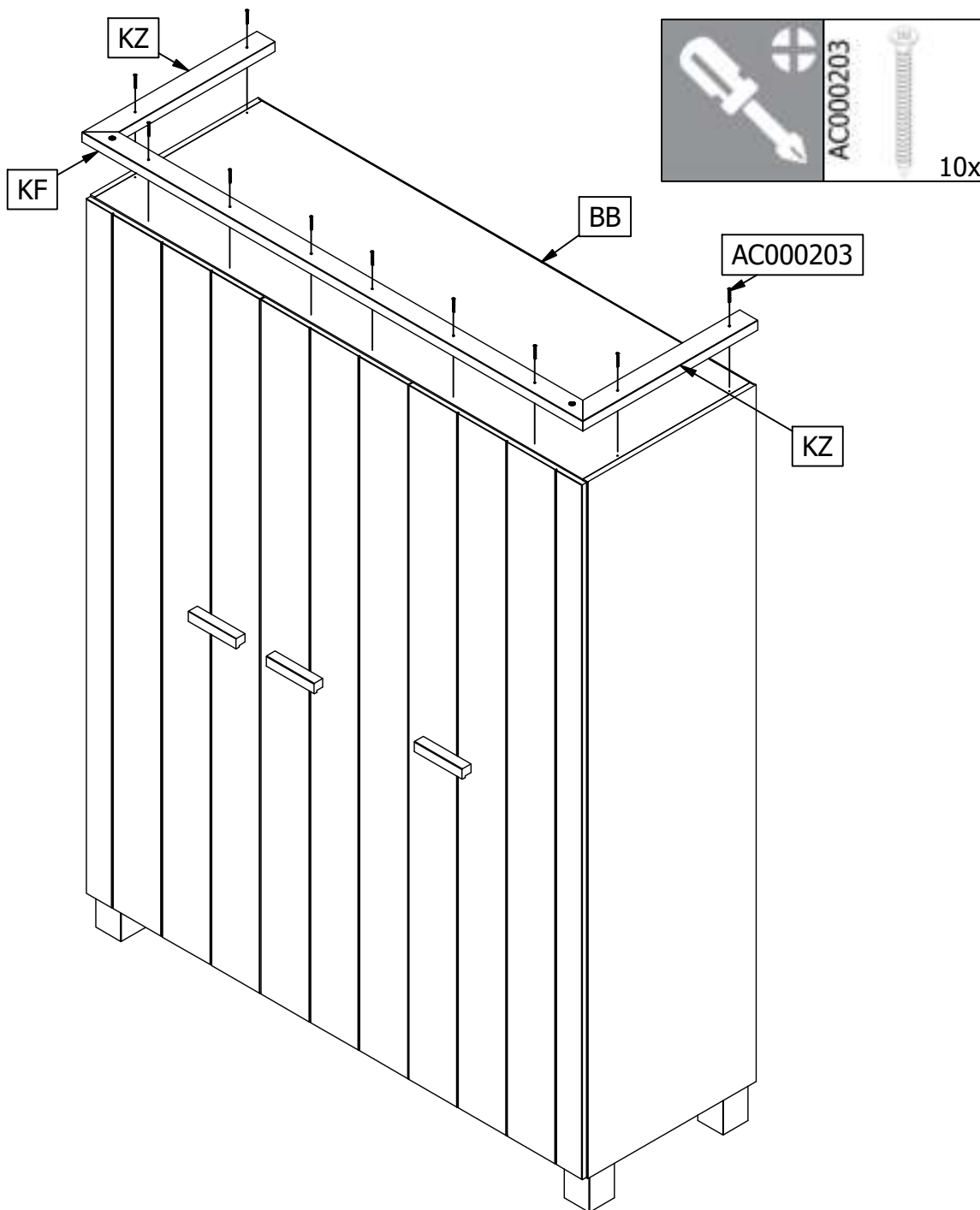

SOCIAL MEDIA

We zijn benieuwd naar het resultaat! Mocht je het met ons willen delen, gebruik #WOOOD op social media.
 We are curious about the result! Would you like to share it with us? Use #WOOOD on social media.
 Wir sind gespannt auf das Ergebnis! Möchten Sie es mit uns teilen? Benutzen Sie #WOOOD in Social Media.
 Nous sommes impatient de connaître le résultat. Souhaitez-vous le partager avec nous? Utilisez #WOOOD sur les médias sociaux.



facebook.com/wood.nl
 instagram.com/madebywood
 pinterest.com/madebywood