

## WEAPONS STORAGE

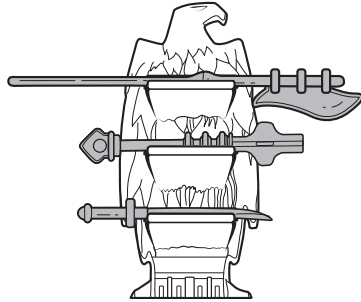

## TO CLOSE CASTLE

1.

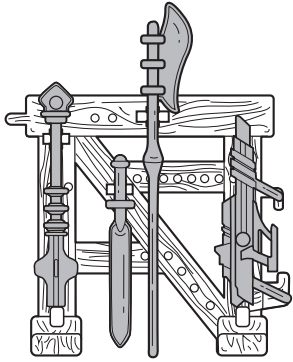
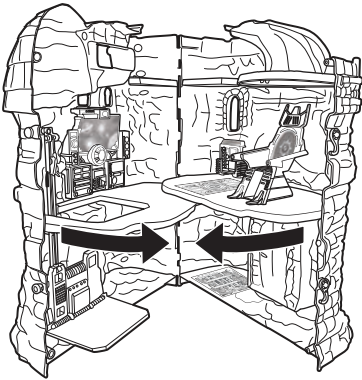

2.

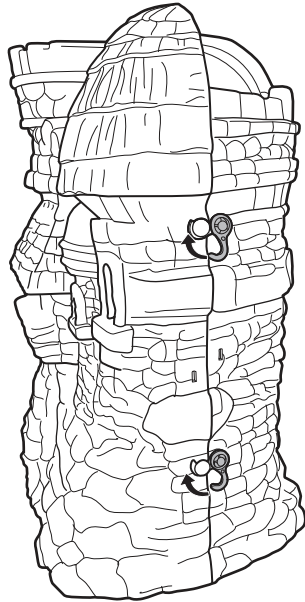

6+

## CASTLE GRAYSKULL®

FORTRESS OF MYSTERY AND POWER  
FOR HE-MAN AND HIS FOES

## INSTRUCTIONS

Keep these instructions for future reference as they contain important information.

## CONTENTS

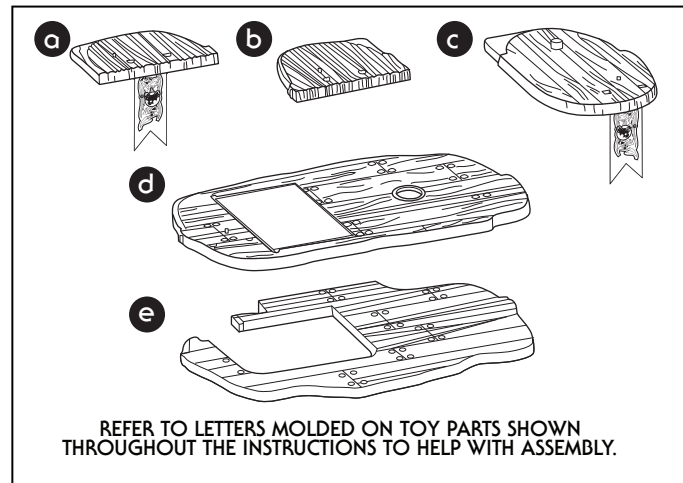
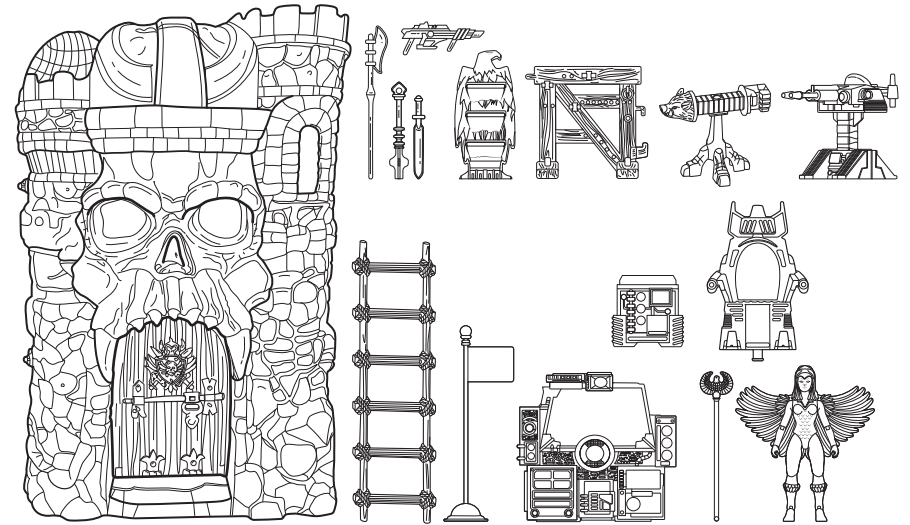

REFER TO LETTERS MOLDED ON TOY PARTS SHOWN  
THROUGHOUT THE INSTRUCTIONS TO HELP WITH ASSEMBLY.

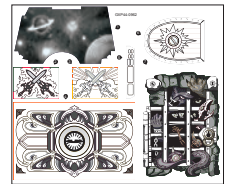

GXP44\_0970G1  
1102582860\_DOM



# 1. APPLY LABELS

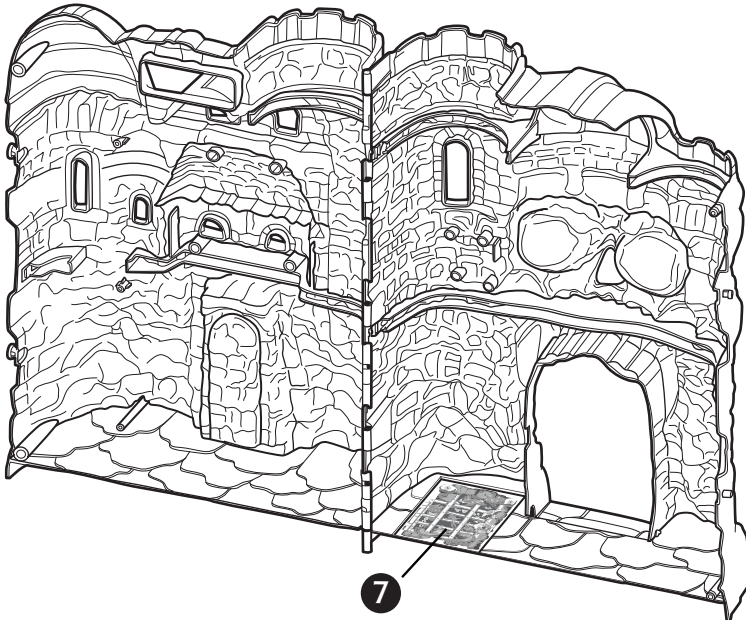
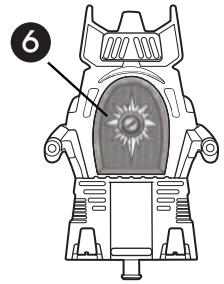
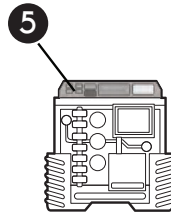
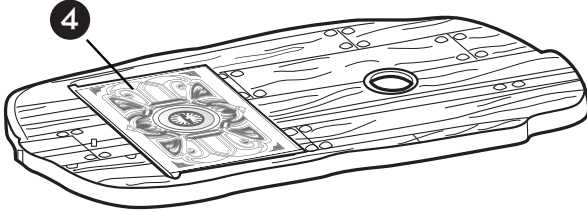
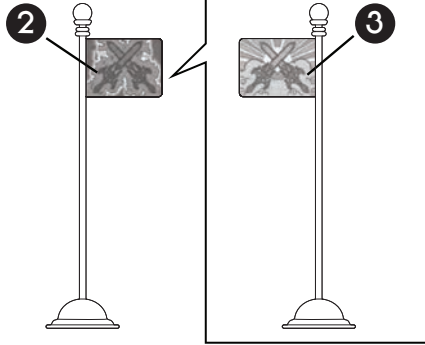
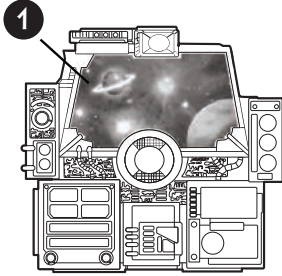

## 2. ASSEMBLY

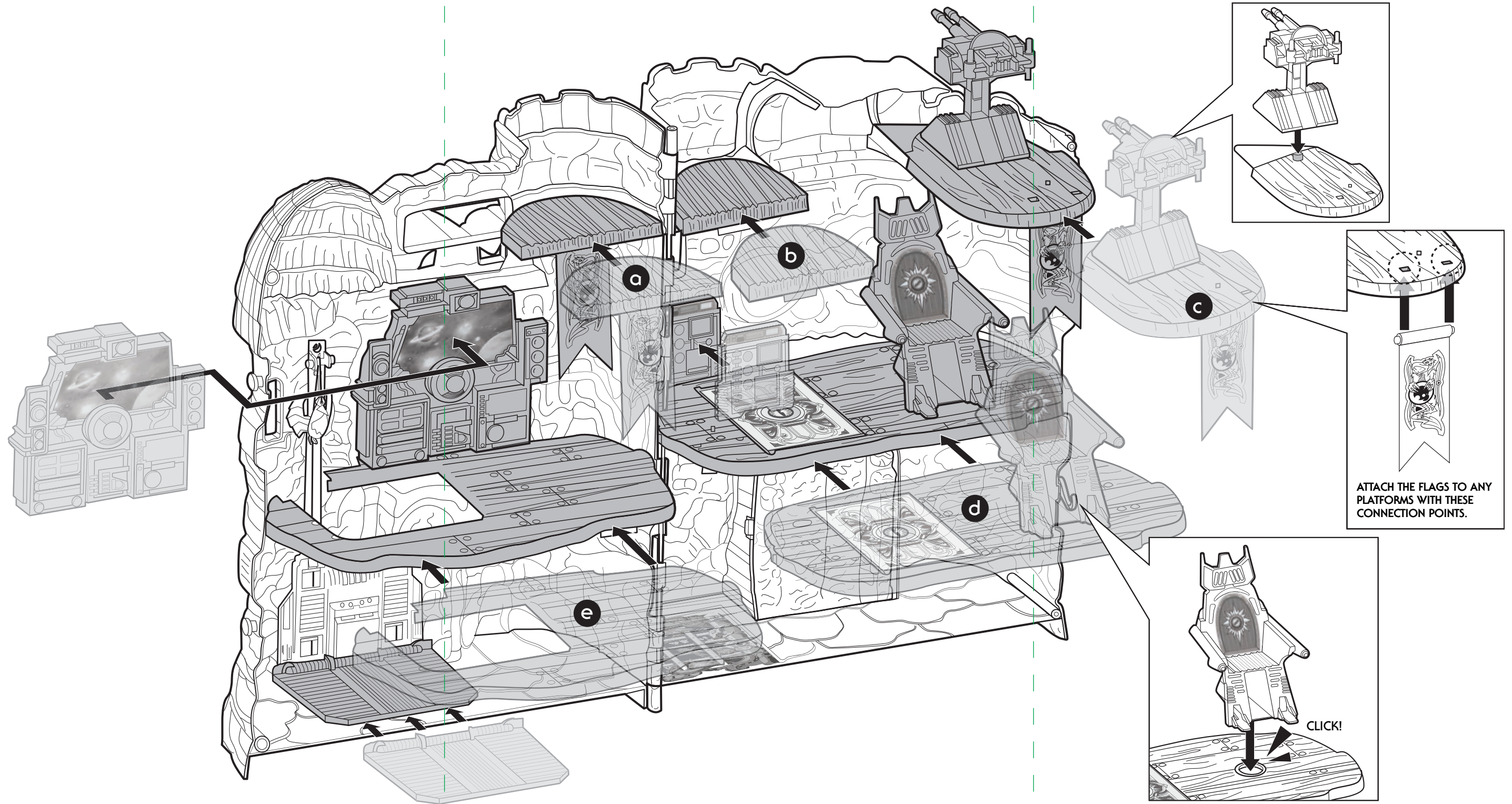

### 3. TO PLAY

PULL OR RELEASE STRING TO GO BETWEEN FLOORS ON THE ELEVATOR.

1. ACTIVATE THE TRAP DOOR BY ROTATING THE THRONE.

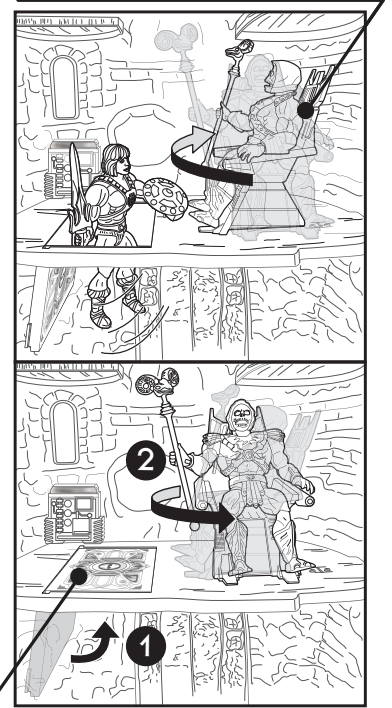

2. CLOSE THE TRAP DOOR, THEN ROTATE THE THRONE TO RESET.

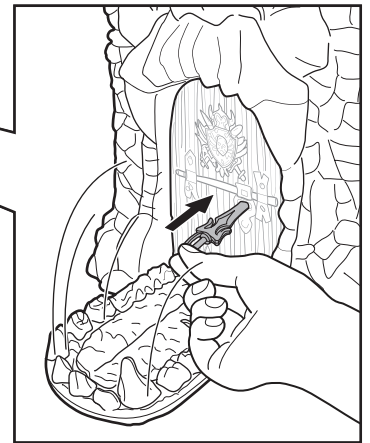

INSERT SWORD TO OPEN THE JAWBRIDGE.

NOT FOR USE WITH SOME MASTERS OF THE UNIVERSE® ORIGINS FIGURES.

INCLUDES SORCERESS FIGURE.  
ADDITIONAL FIGURES AND ACCESSORIES NOT INCLUDED, SUBJECT TO AVAILABILITY.

