

K'nex

CLASSIC CONSTRUCTIONS

Building Set

CONSTRUCTIONS CLASSIQUES

Jeu de construction

70

BUILDS MODÈLES*

Ages

7-12

17435



WARNING:

CHOKING HAZARD – Small parts.
Not for children under 3 years.



ATTENTION :

RISQUE D'ÉTOUFFEMENT – Pièces de petite taille.
Ne convient pas aux enfants de moins de 3 ans.

IMAGINE™



* Modelos
Modelle
Modelli
Modelo
Modellen

(EN) CONTENTS

Fishing Pole	4	Pick-Up Truck	16
Whale	5	Four Wheeler	18
Lobster	6	Megaphone	20
Surfer	7	Camera	23
Hammock	8	Waverunner	26
Horse	10	Muscle Car	30
Picture Frame	12	Building Ideas	34
Treasure Chest	14		

K'nex Building Basics

Start Building

To begin your model, find the **1** and follow the numbers. Each piece has its own shape and color. Just look at the pictures, find the pieces in your set that match and then connect them together. Try to face your model in the same direction as the instructions while you build. The arrows show you where the parts connect, but not all connection points have arrows. Faded colors show you this section is already built.

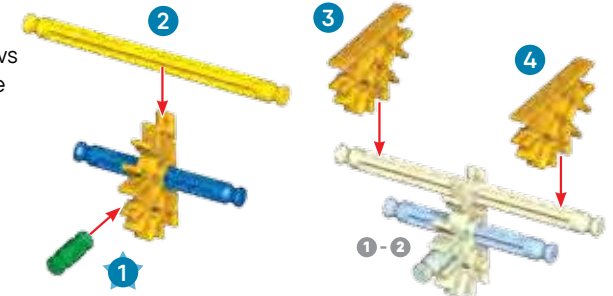

Parts List

Before you start building, be sure to compare the parts in your set with the parts list here. If anything is missing, call or write to us using the information on the back cover. We are here to help you!



Spacers

There are places in your model where you need to use spacers. Be sure to use the correct number of spacers shown in the instructions.



Connectors

You can slide these special connectors together. Push tightly until you hear a "click". Pay close attention to the instructions and position them horizontally or vertically exactly as they are shown.

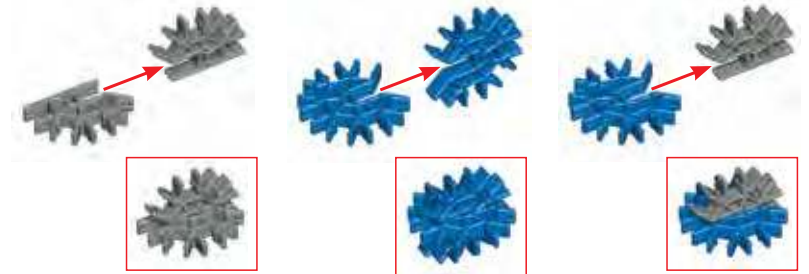

Flexi-rod

A Flexi-rod is a rod that you bend to make curves. It will be easier to attach to your model if you bend it back and forth first.



Esenciales de construcción K'NEX

(FR) CONTENUS

Démarrer la construction

Pour commencer le modèle, trouver l'étape numérotée 1 trouver les numéros. Chaque pièce a sa propre forme et sa propre couleur. Regarder les illustrations, trouve les pièces qui correspondent à l'illustration et les assembler. Pour vous faciliter la tâche, orienter le modèle dans le même sens que les instructions.

Les flèches indiquent où les pièces s'assemblent, mais les points de raccordement n'ont pas tous des flèches. Les pièces de couleur délavées sont celles déjà assemblées.

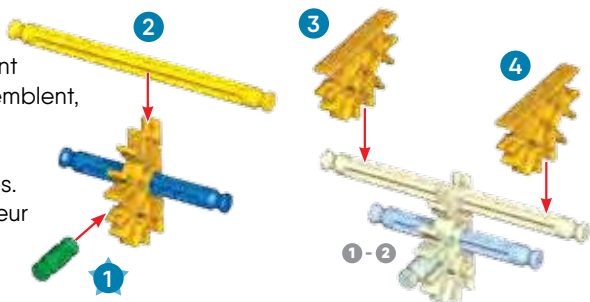

Espaceurs

Il y a des endroits sur le modèle où des espaceurs sont nécessaires. S'assurer d'utiliser la bonne couleur et le nombre d'espaceurs indiqué sur les instructions.



Connecteurs

Vous pouvez assembler ces connecteurs tout à fait uniques en les faisant glisser l'un dans l'autre. Pousser fort jusqu'au « clic ». Lire les instructions attentivement et les positionner horizontalement ou verticalement, en suivant exactement les illustrations.

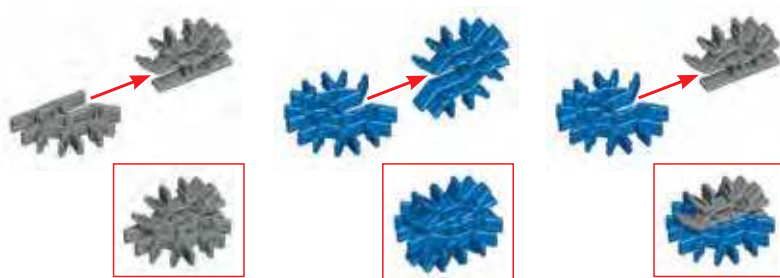

Tiges Flexibles

Un Tiges Flexibles est une tige que tu peux courber pour faire des courbes. Elle pourra être attachée plus aisément à ton modèle si tu la plies en avant et en arrière plusieurs fois.



Canne à Pêche	4	Camion de Collecte	16
Baleine	5	Vehicule a quatre	
Homard.....	6	roues	18
Surfer.....	7	Porte-voix	20
Hamac	8	Caméra.....	23
Cheval	10	Surfer	26
Cadre Photo	12	Grosse Cylindree	30
Coffre au Trésor	14	Idées de Construction..	34

Liste des pièces

Avant de commencer, s'assurer de comparer les pièces dans la boîte à la liste de pièces fournie ici. S'il manque quelque chose, nous téléphoner ou nous écrire en vous servant des informations figurant au verso de la notice. Nous sommes là pour vous aider.

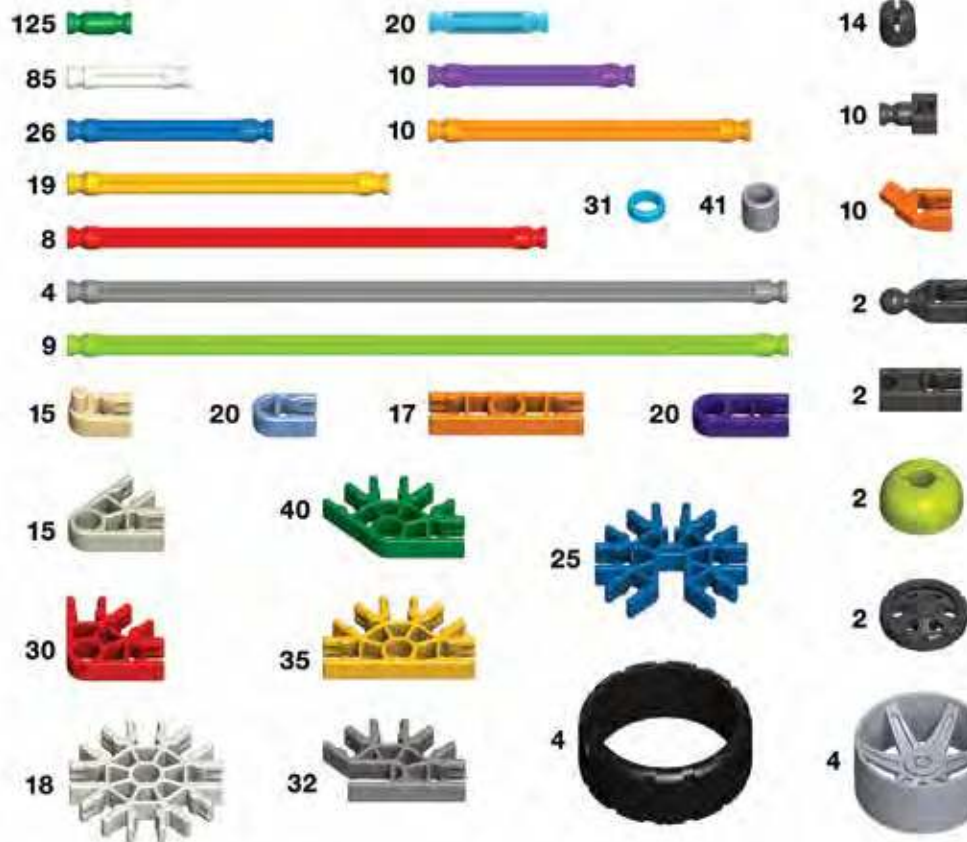

Fishing Pole

Canne à Pêche

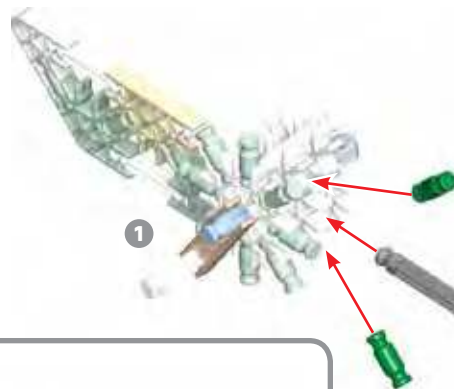
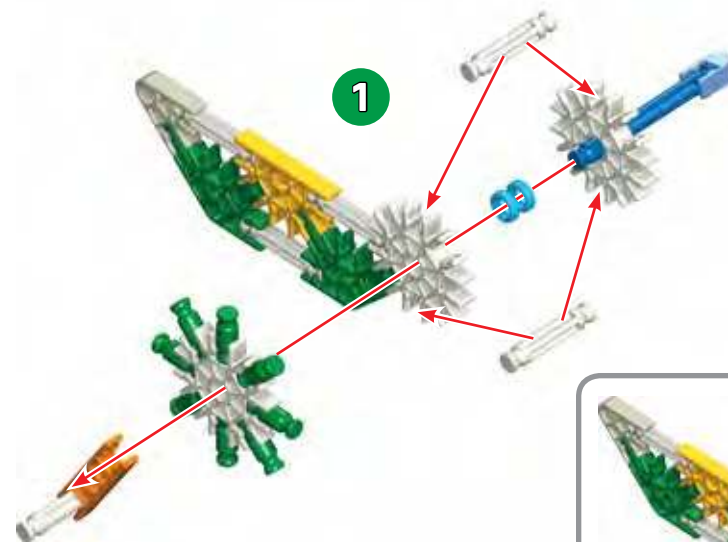

2

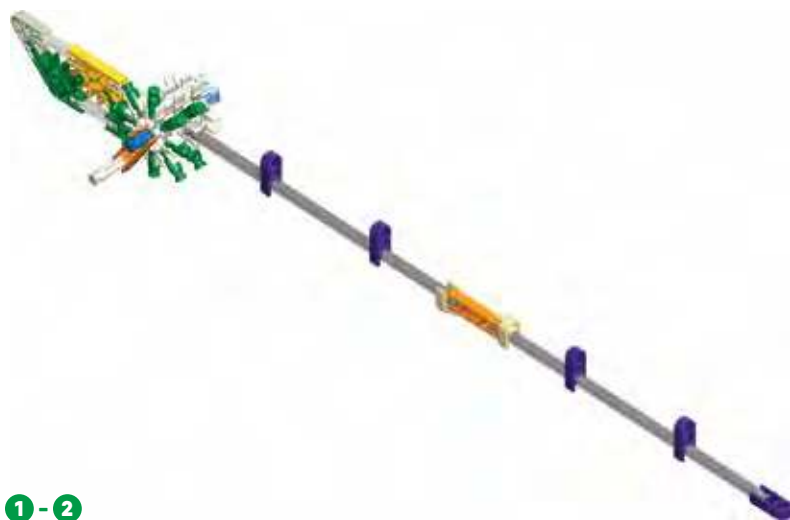

1 - 2

CAUTION: Keep hands, face, hair and clothing away from all moving parts.

ATTENTION : Gardez les cheveux, les doigts, la figure et les vêtements à l'écart de toutes les pièces mobiles.

PRECAUCIÓN: Mantén el cabello, los dedos, la cara y la ropa alejada de las piezas móviles.

VORSICHT: Haare, Finger, Gesicht und Kleidungsstücke nicht mit beweglichen Teilen in Berührung kommen lassen.

ATTENZIONE: Tenere i capelli, le dita, il viso e i vestiti lontano da tutte le parti in movimento.

CUIDADO: Mantém o cabelo, os dedos, a cara e a roupa afastados de todas as peças móveis.

LET OP: Hou het haar, de vingers, het gezicht en kledij verwijderd van alle bewegende onderdelen.

WARNING: CHOKING HAZARD – Small parts. Not for children under 3 years.

ATTENTION : RISQUE D'ÉTOUFFEMENT – Pièces de petite taille. Ne convient pas aux enfants de moins de 3 ans.

ADVERTENCIA: PELIGRO DE ASFIXIA – Piezas pequeñas. No para niños menores de 3 años.

ACHTUNG: ERSTICKUNGSGEFAHR – Kleinteile. Nicht geeignet für Kinder unter 3 Jahren.

AVVISO: PERICOLO DI SOFFOCARE – Pezzi piccoli. Non adatto per bambini sotto 3 anni.

AVISO: PERIGO DE SUFOCAÇÃO – Peças pequenas. Não se destina a crianças com menos de 3 anos de idade.

WAARSCHUWING: INSLIKKINGSGEVAAR – Kleine onderdelen. Niet geschikt voor kinderen jonger dan 3 jaar.

Whale Baleine

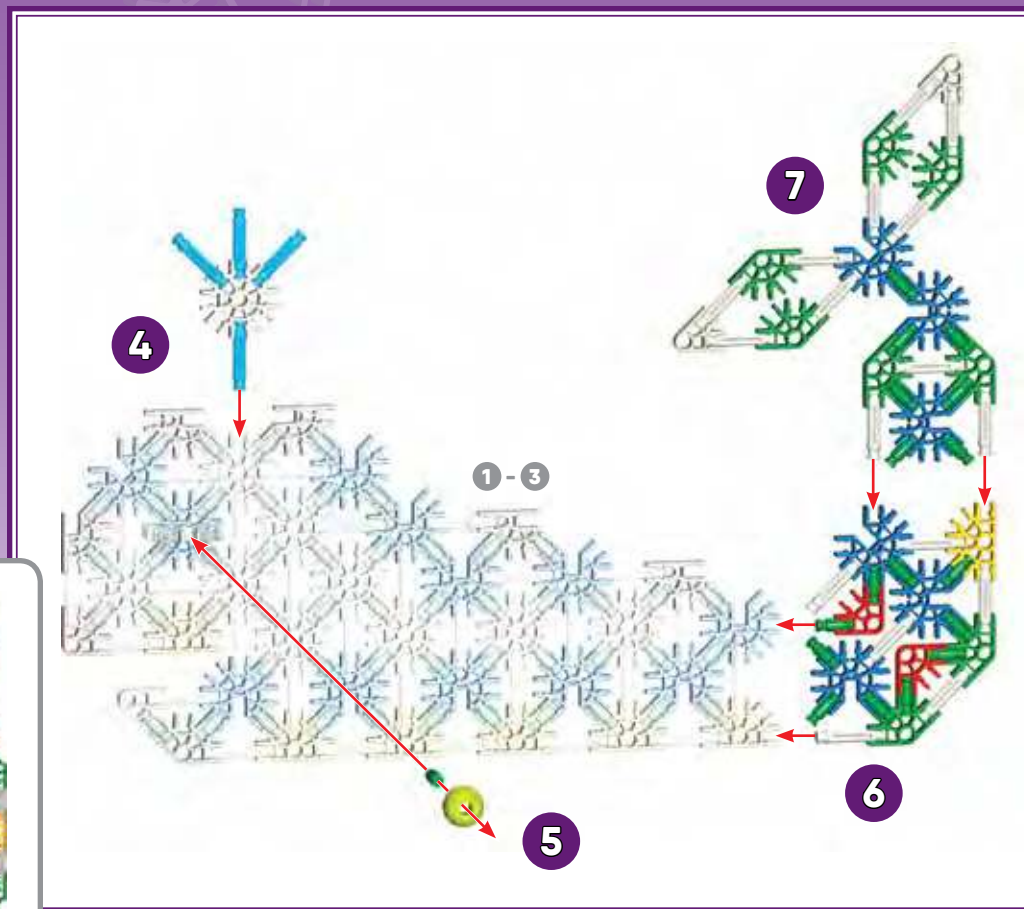
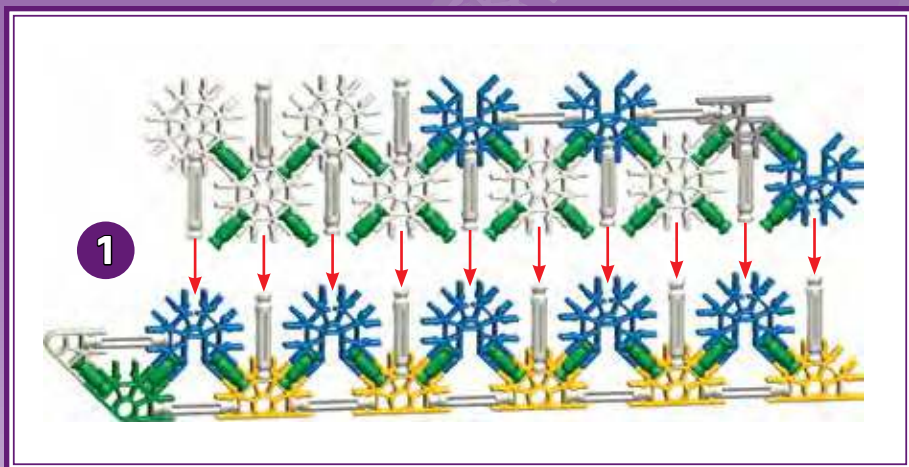
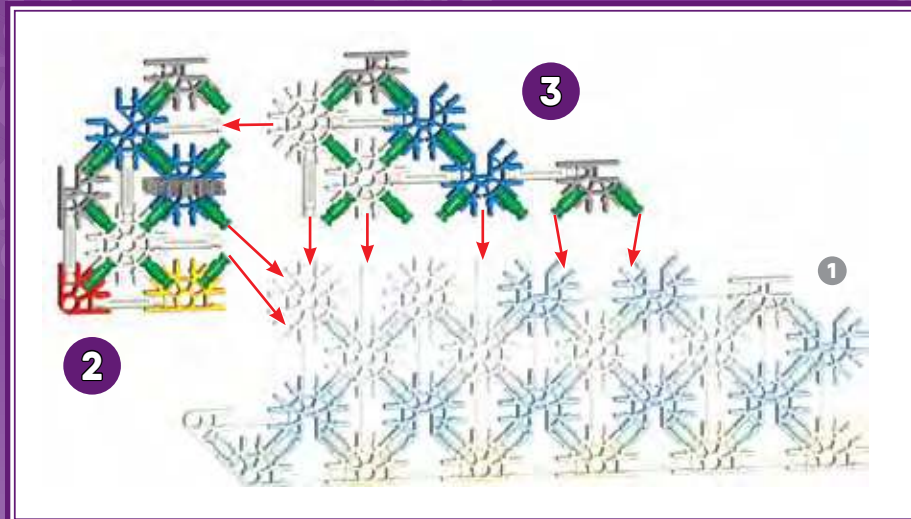

Lobster Homard

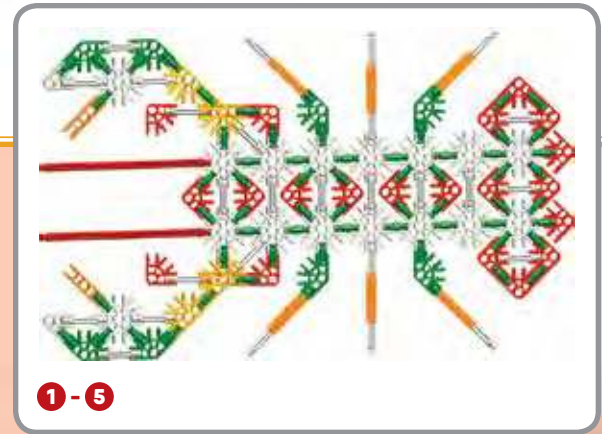
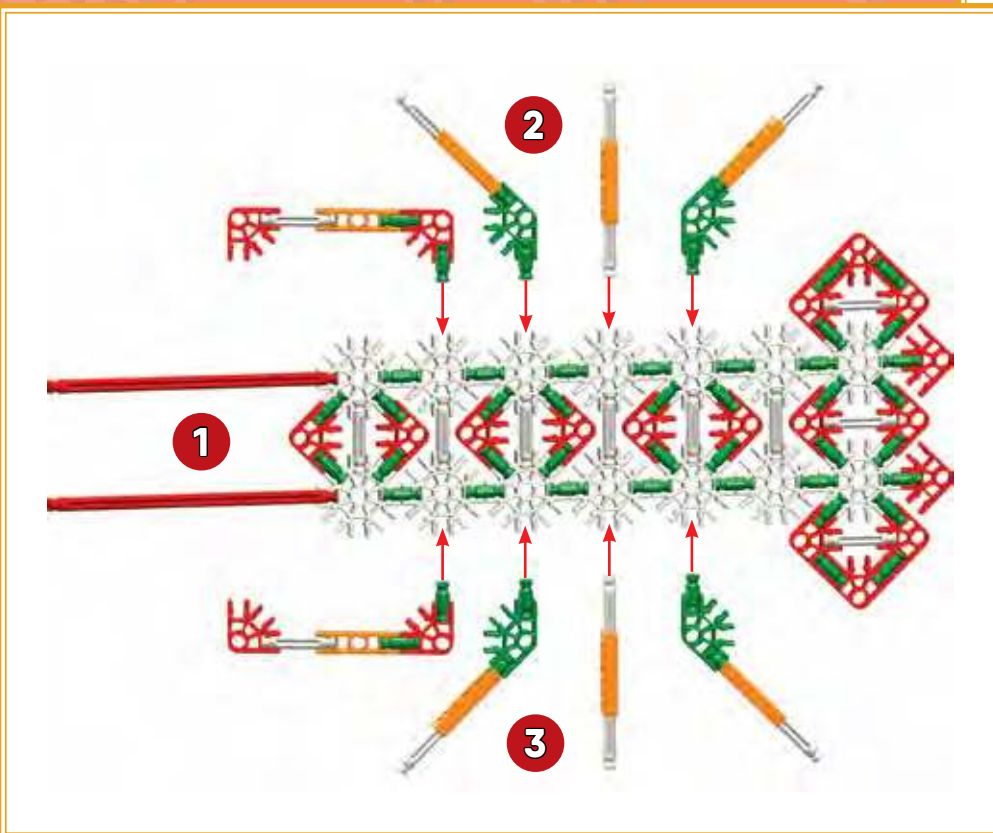
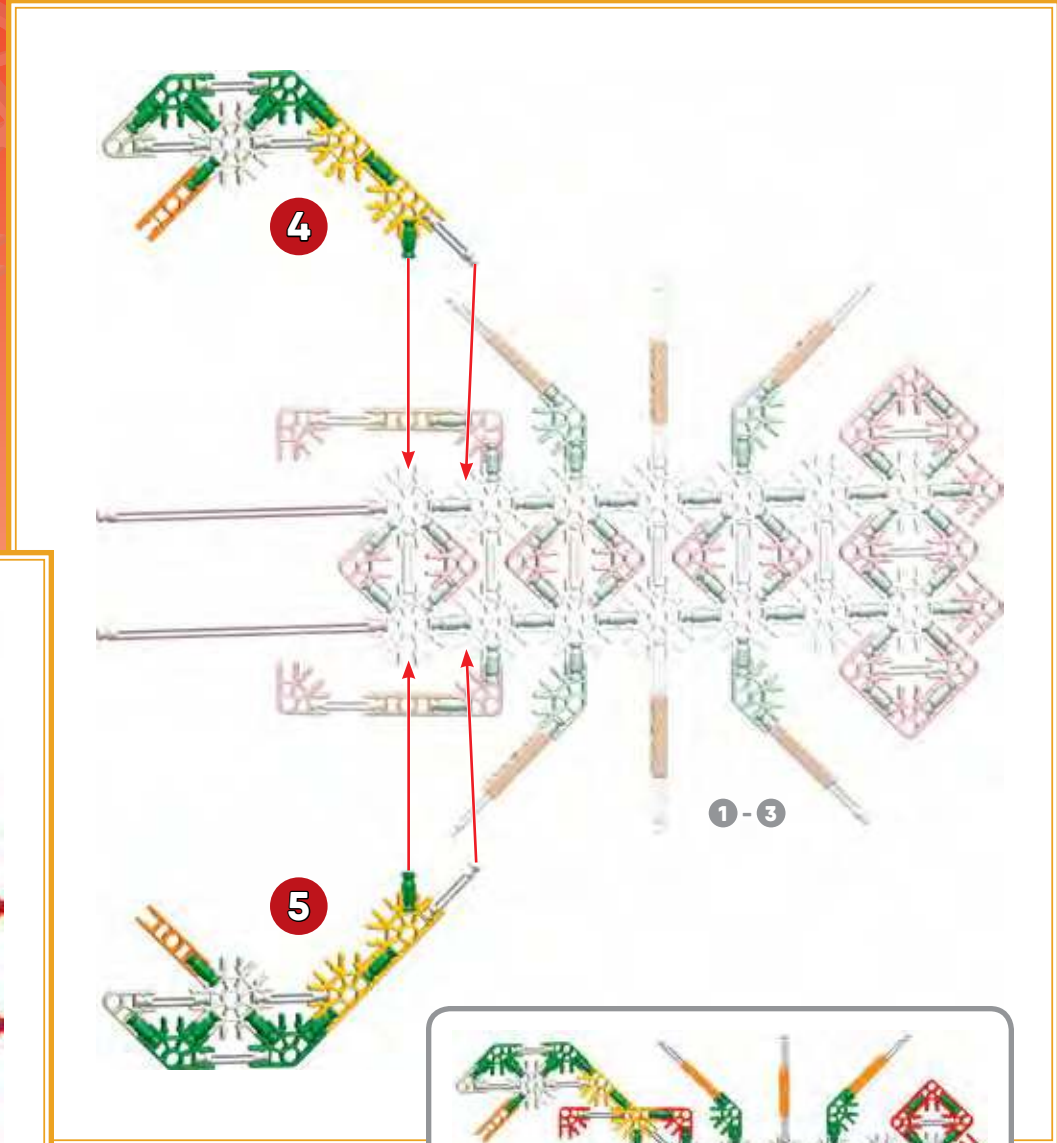

Surfer Surfer

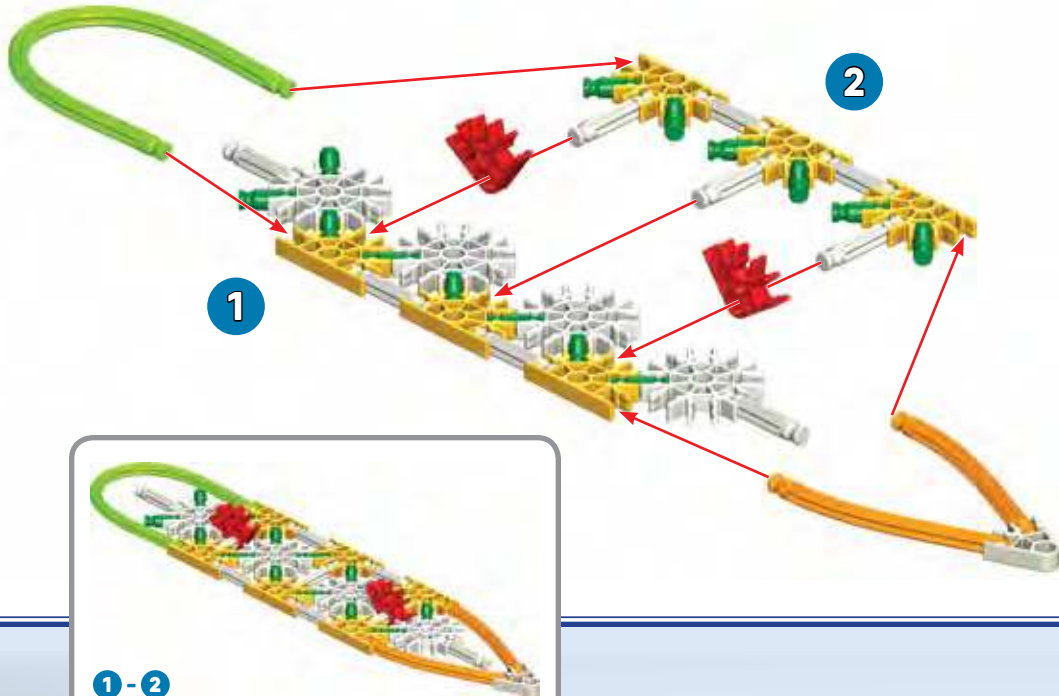

Hammock Hamac

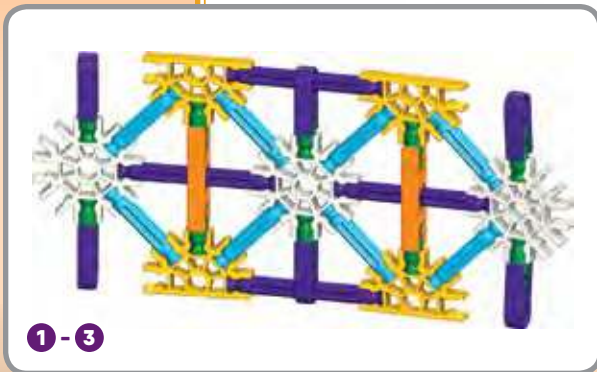
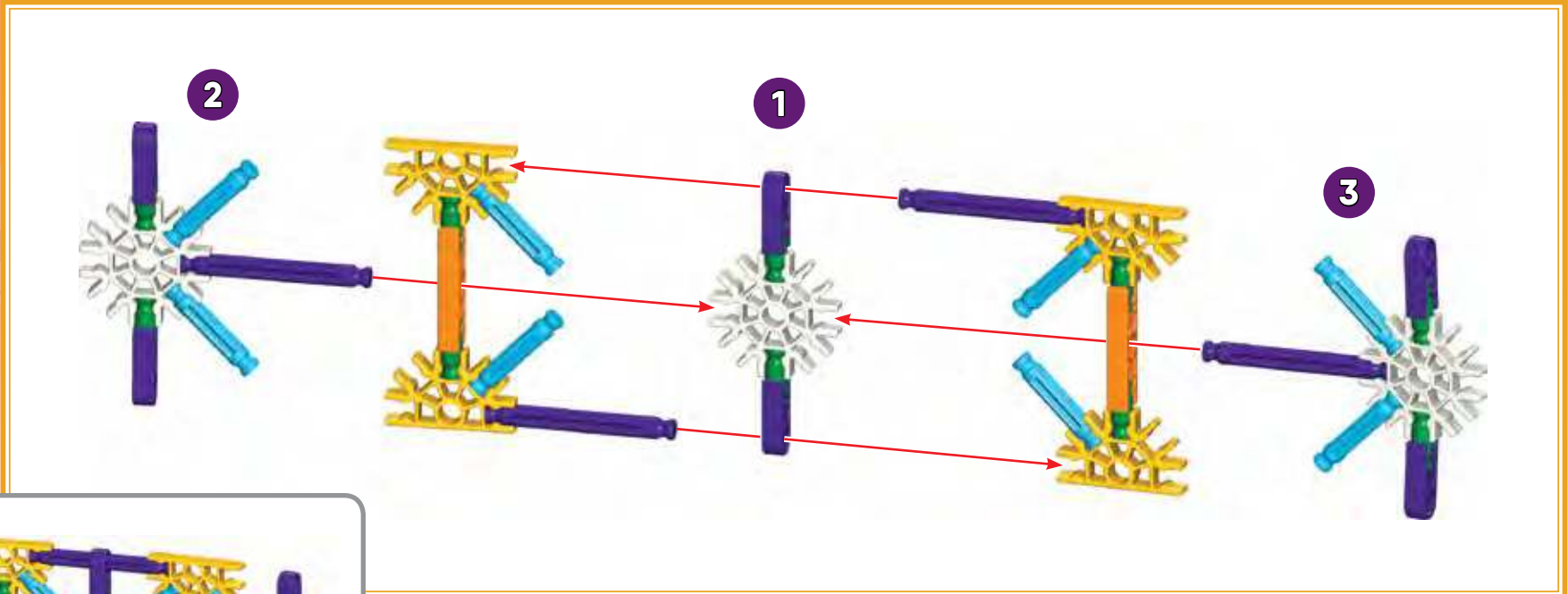

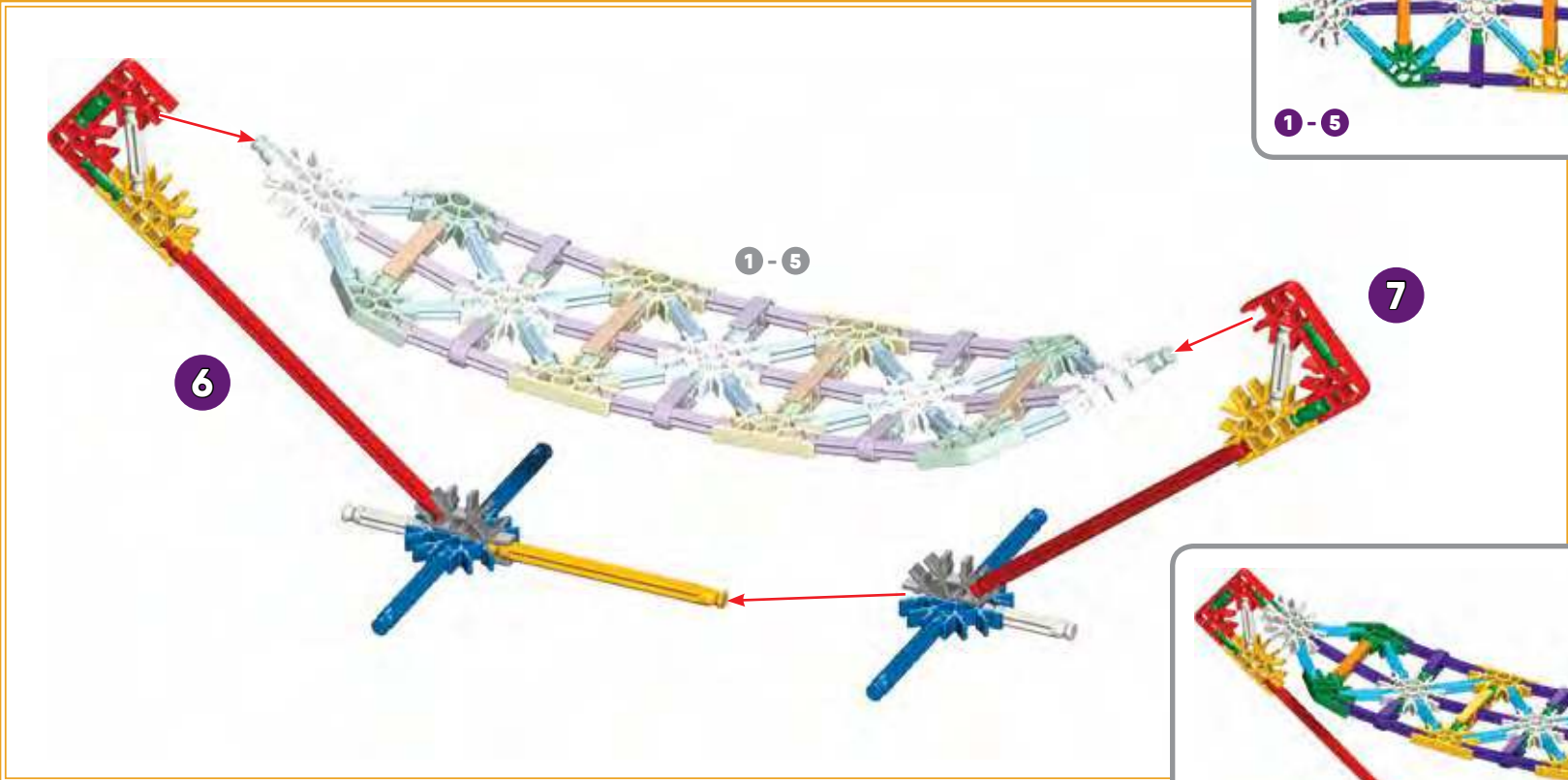
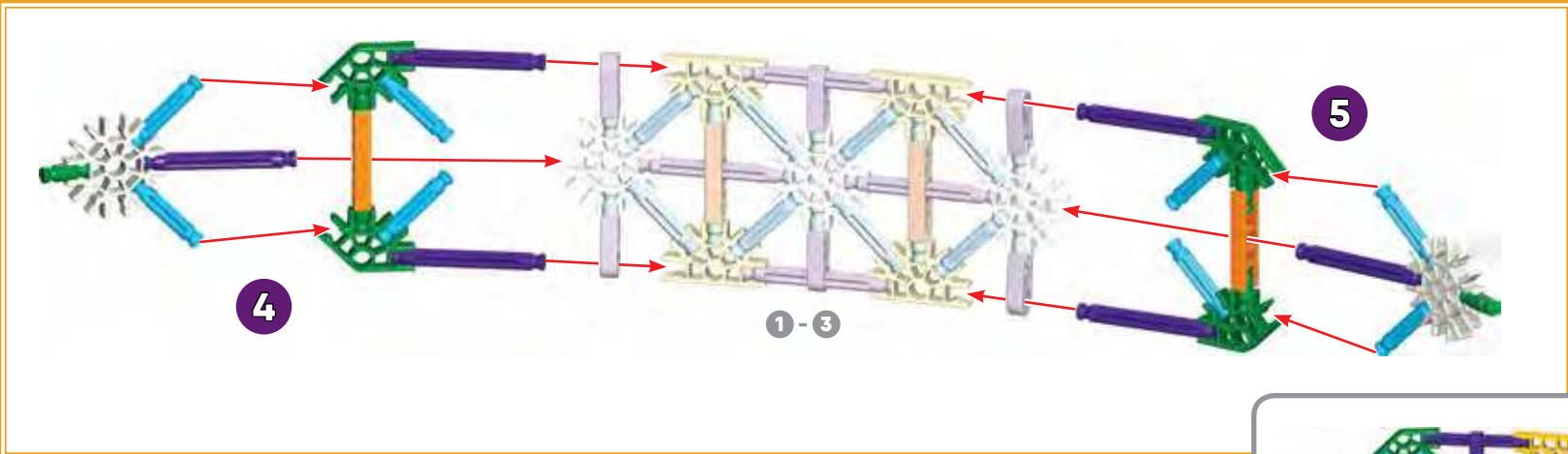

Hammock
Hamac

Horse Cheval

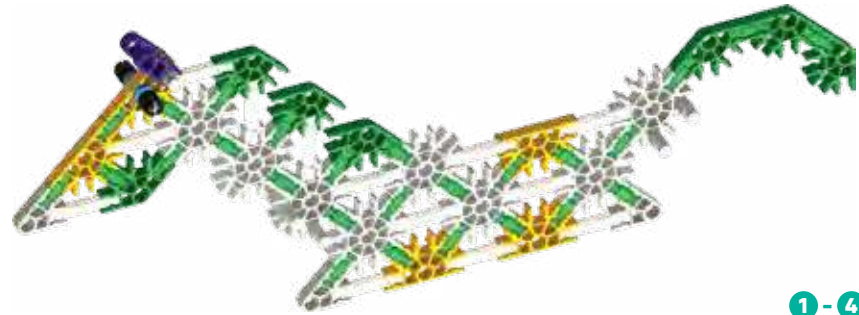

1-4

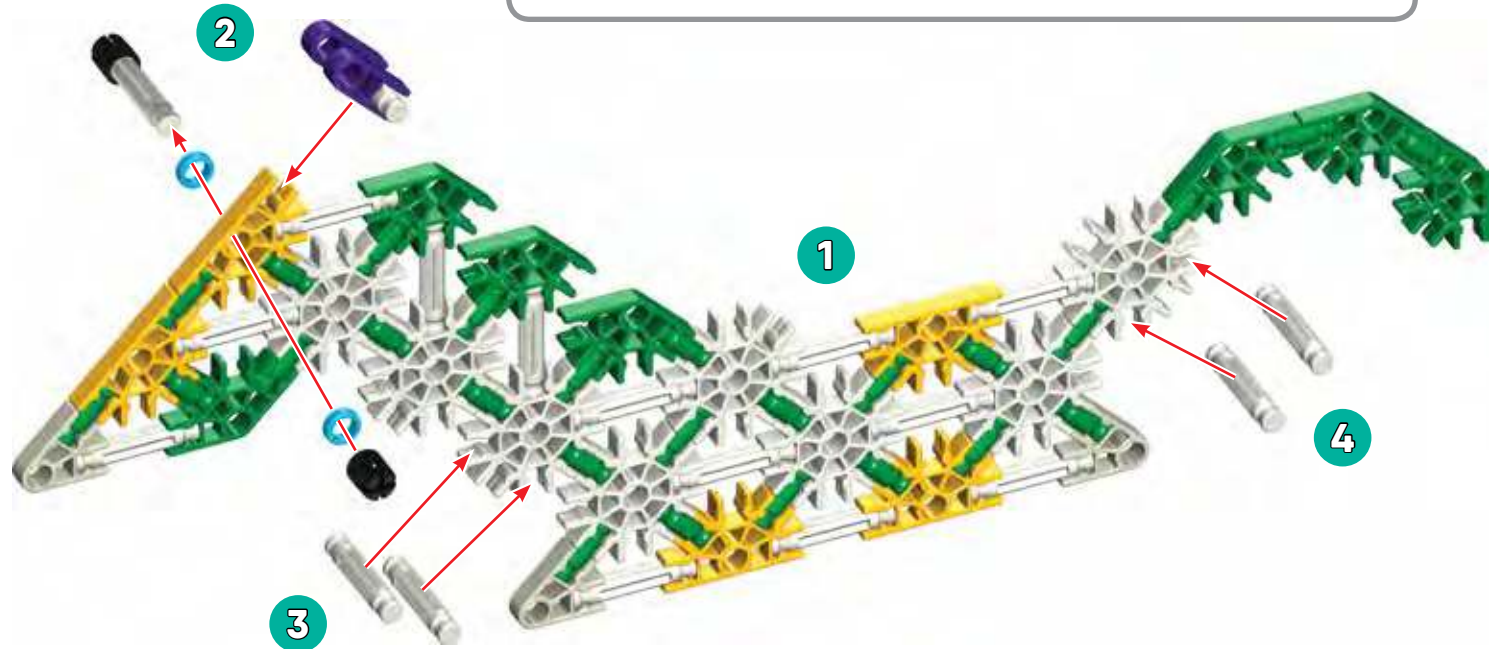

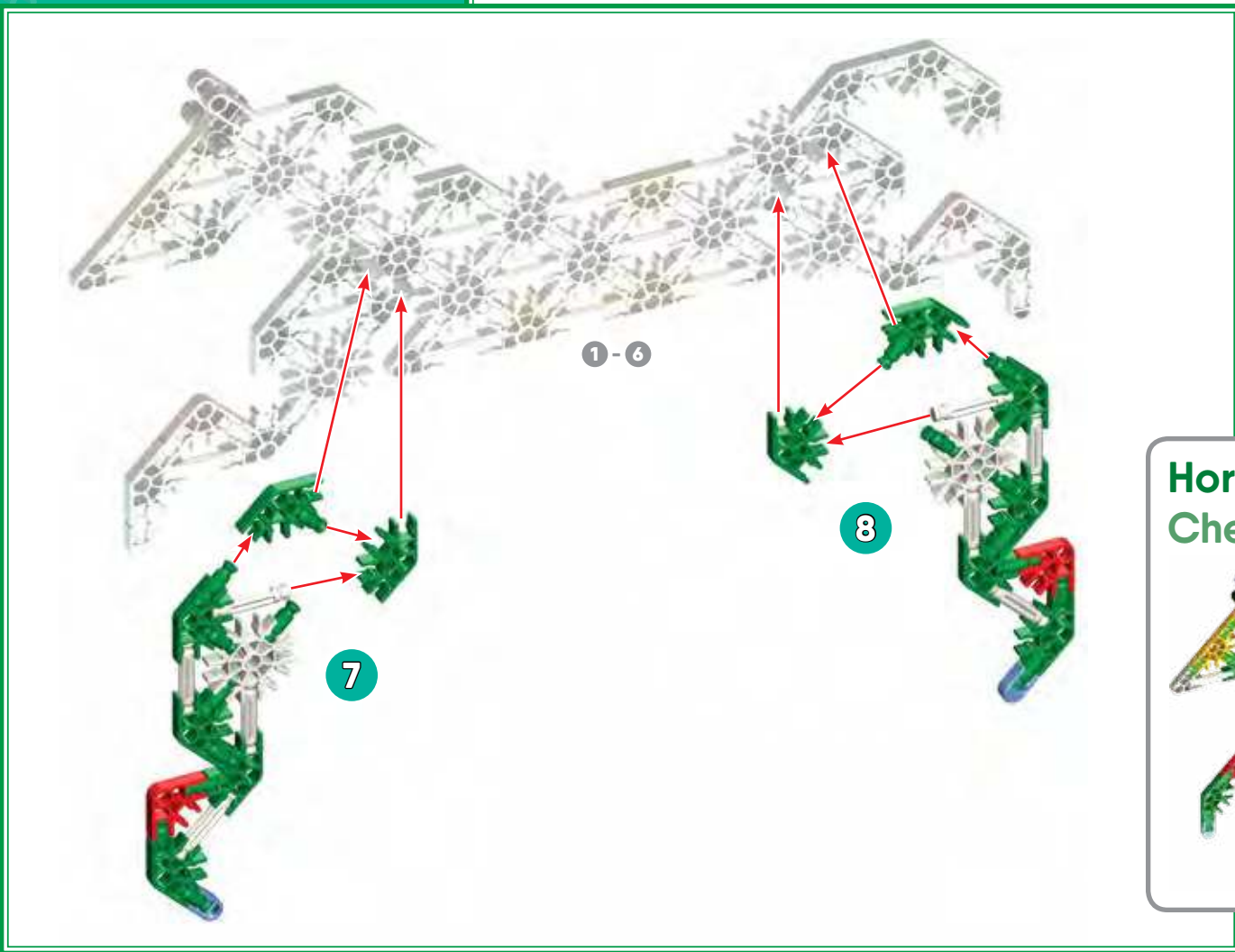
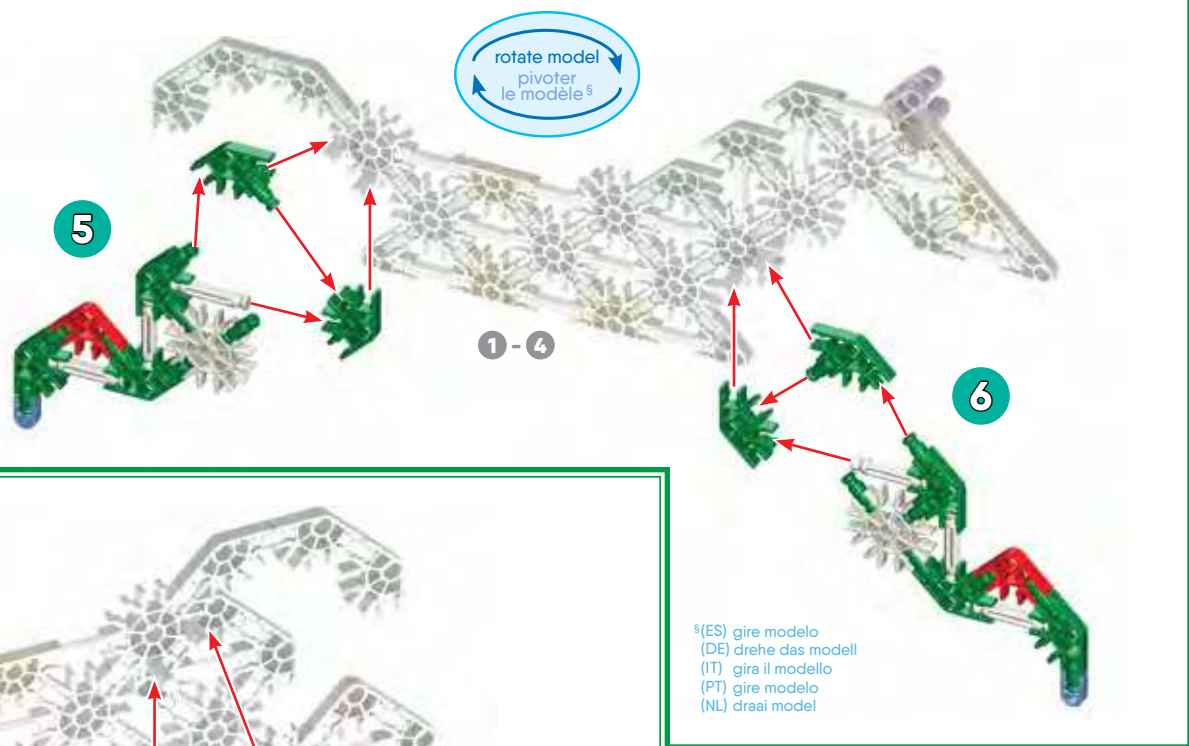
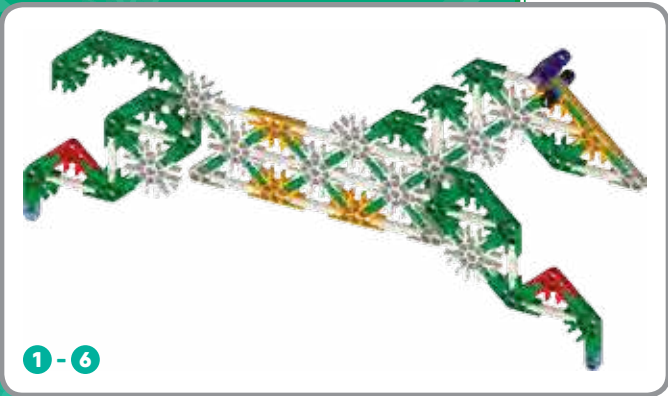

Picture
Frame
Cadre
Photo

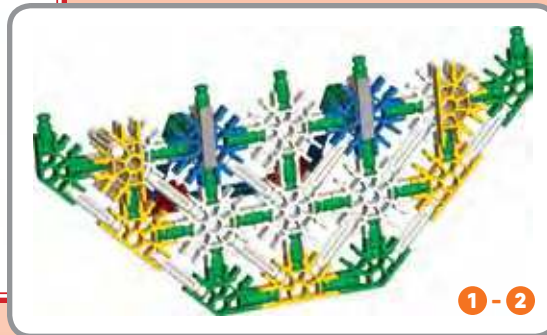
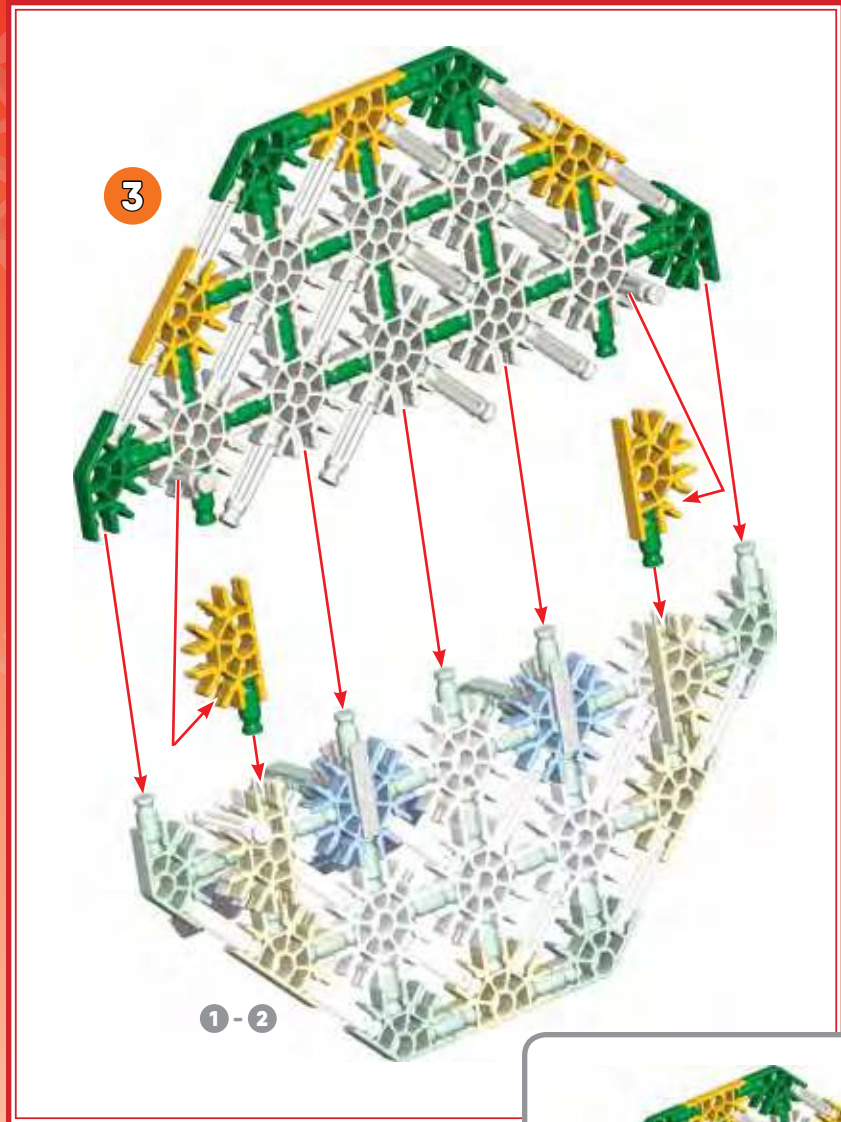
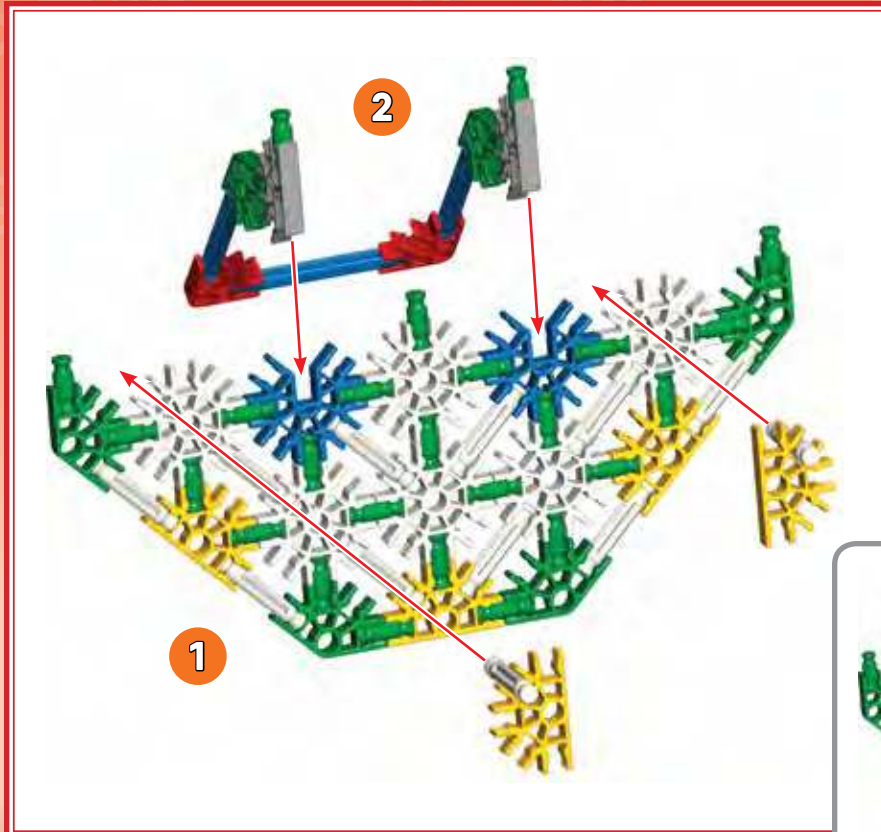
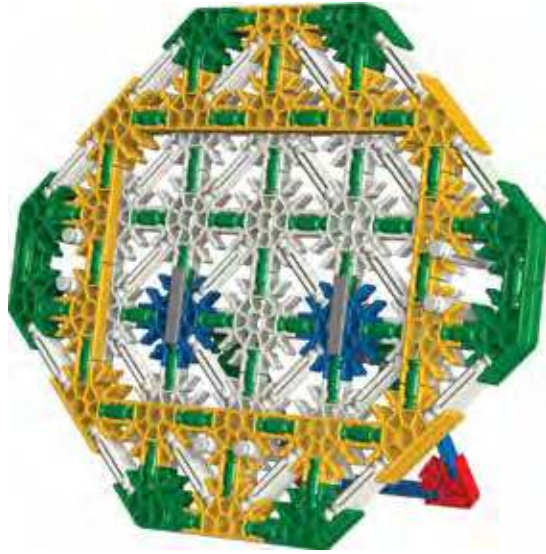

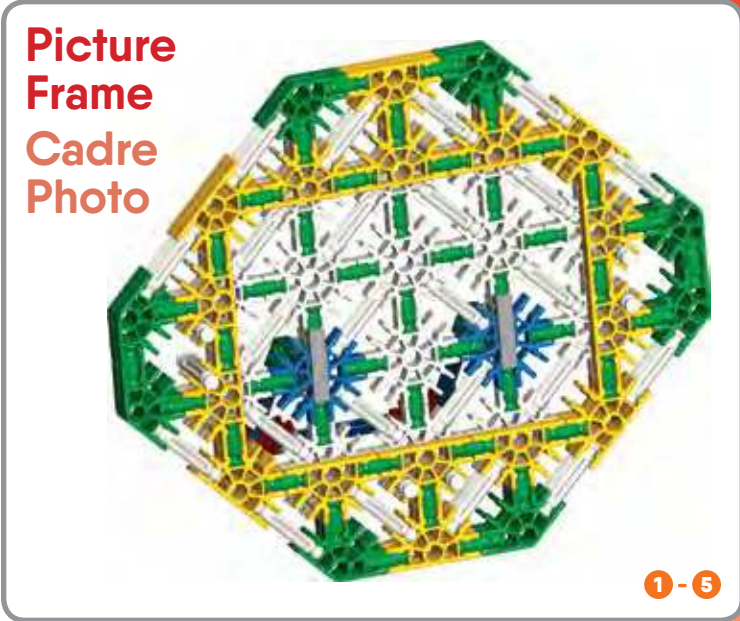
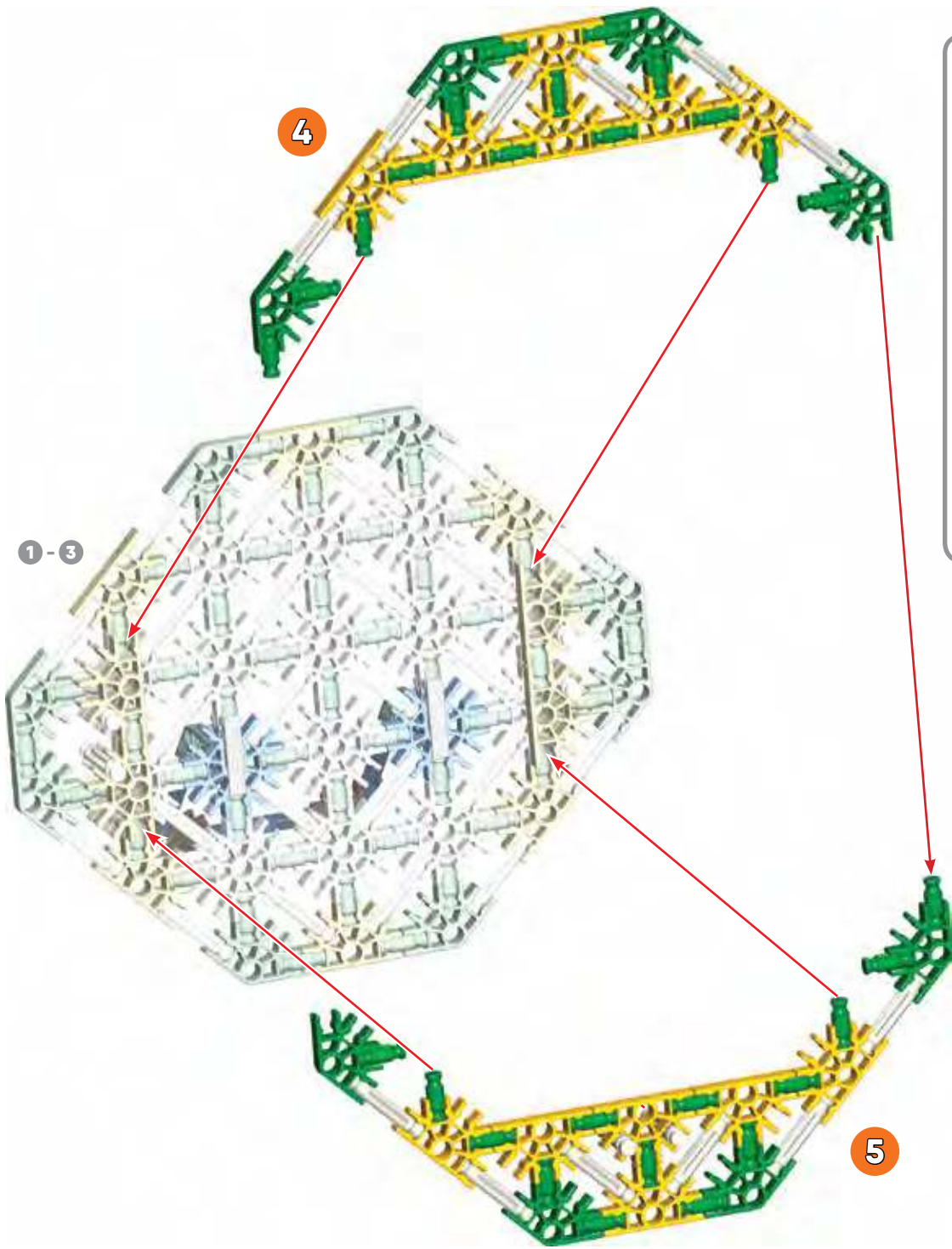

Treasure Chest Coffre au Trésor

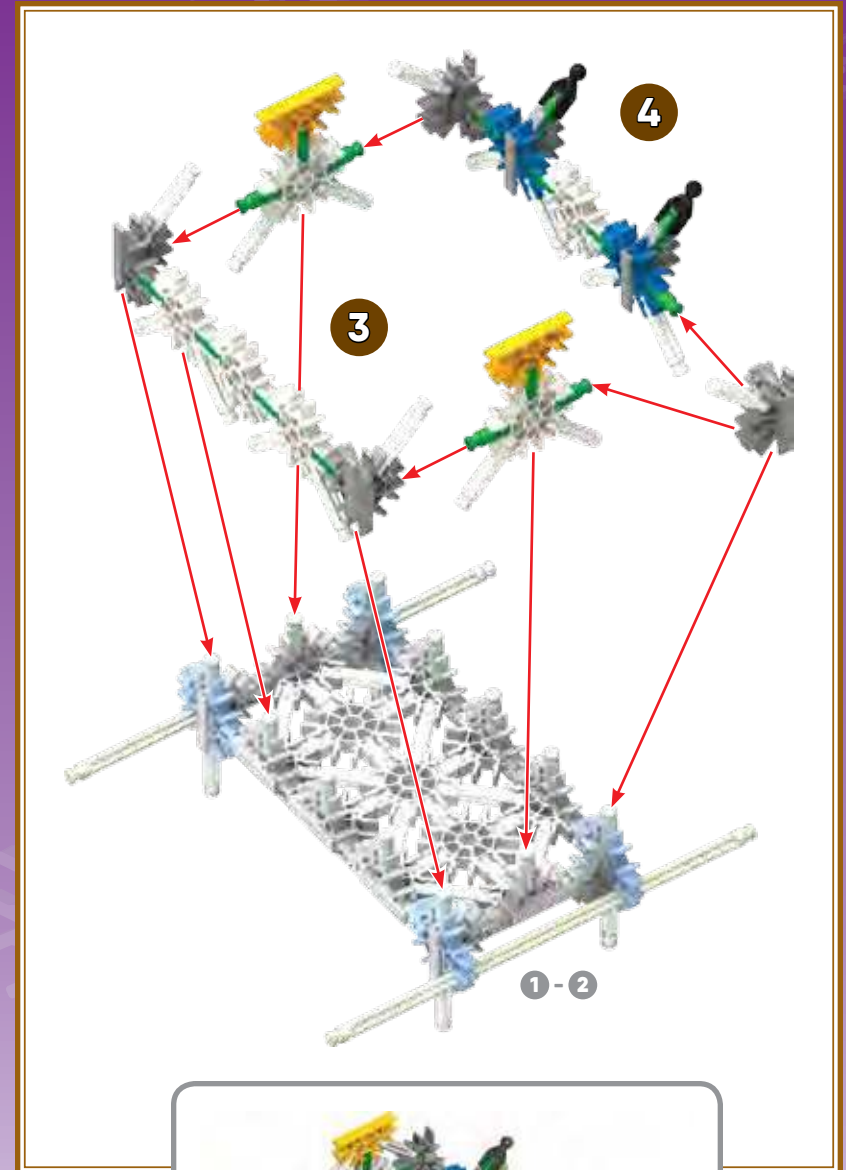
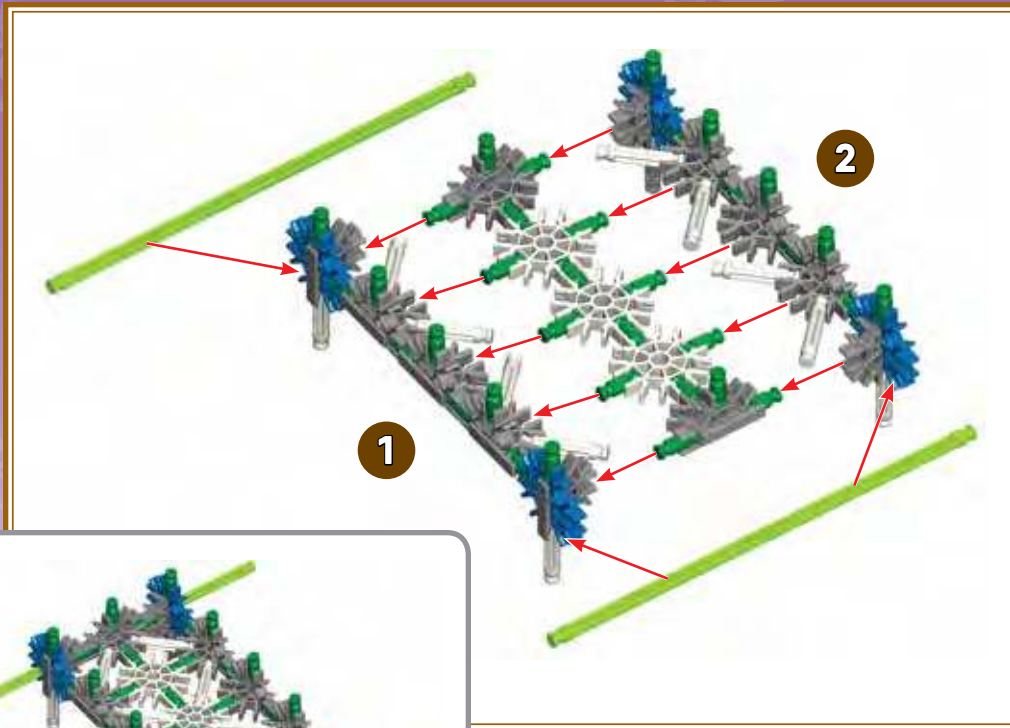

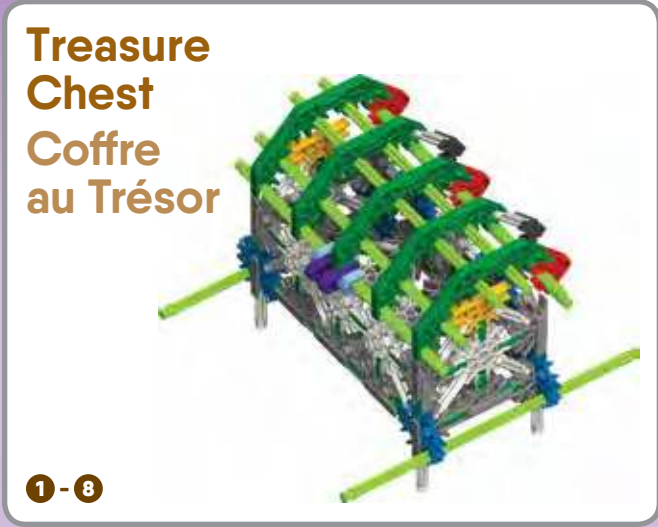
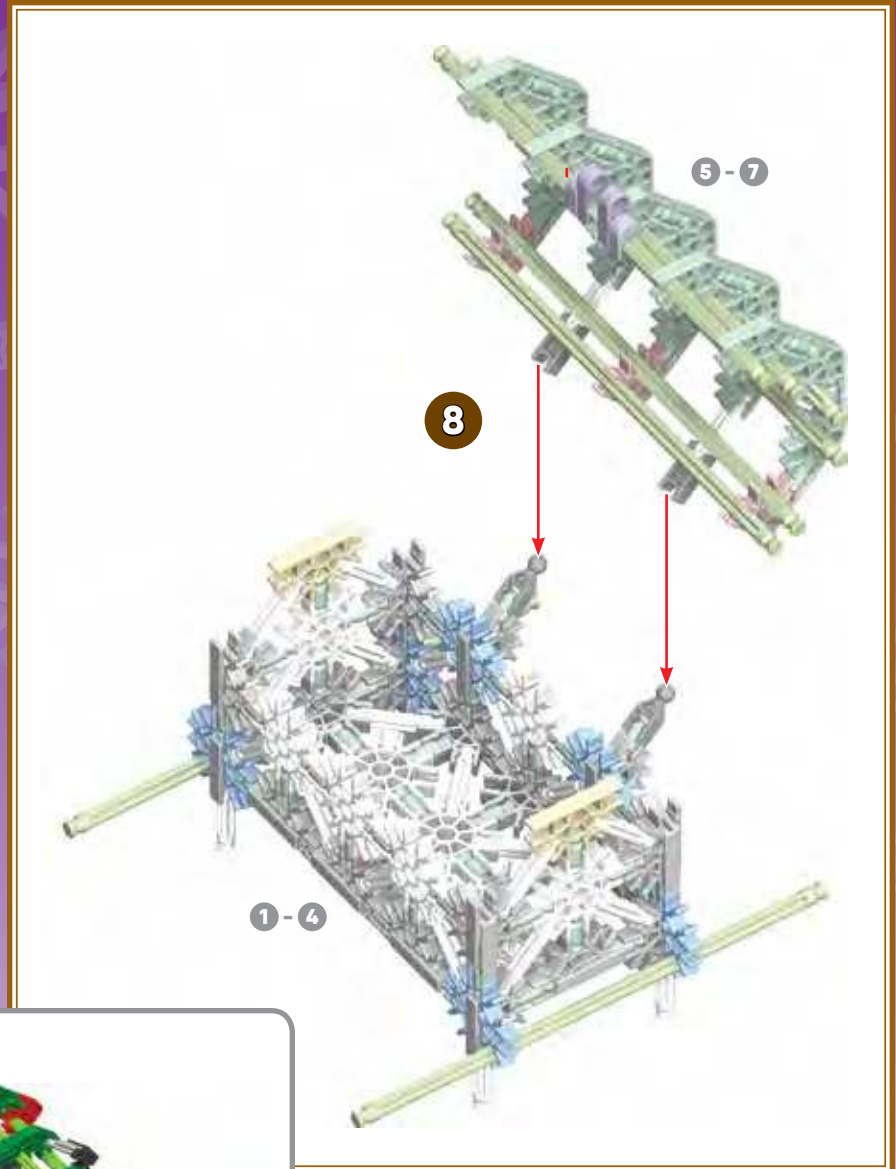
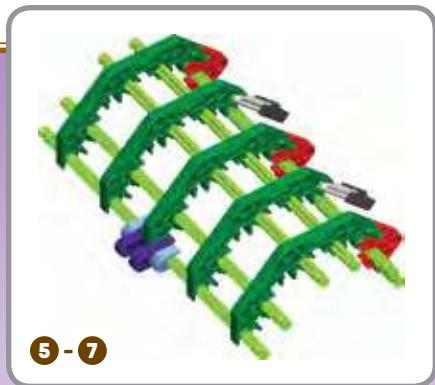
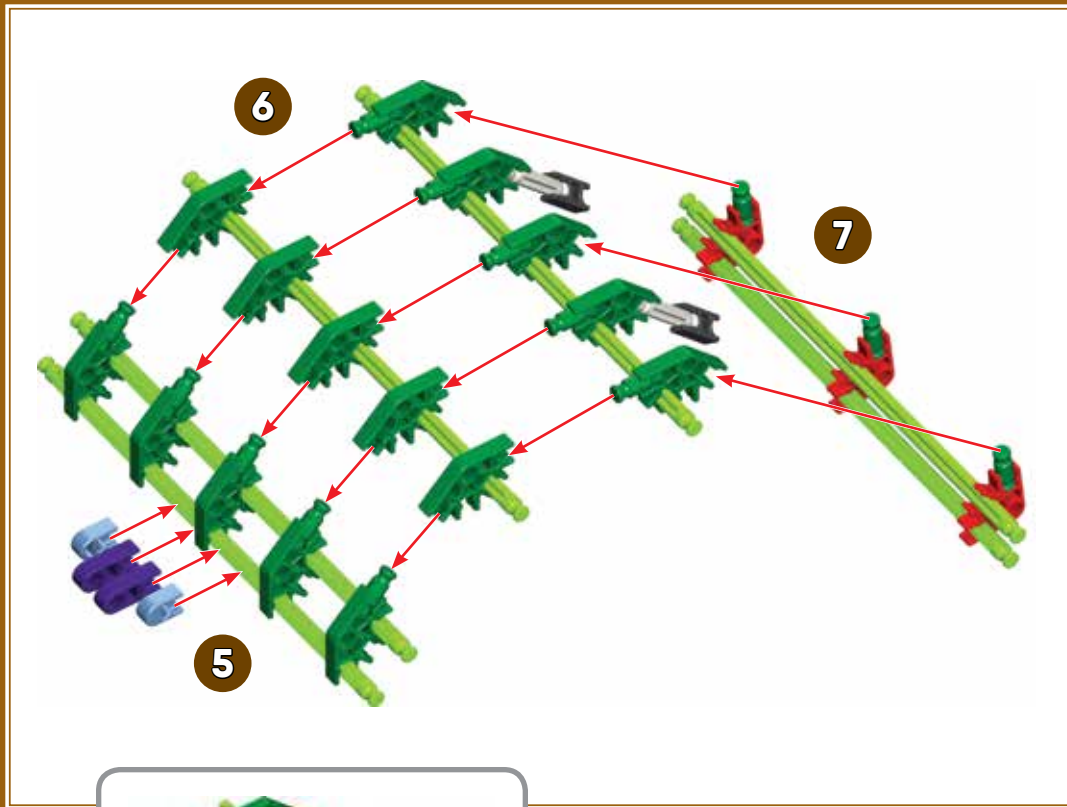

Pick-Up Truck

Camion de Collecte

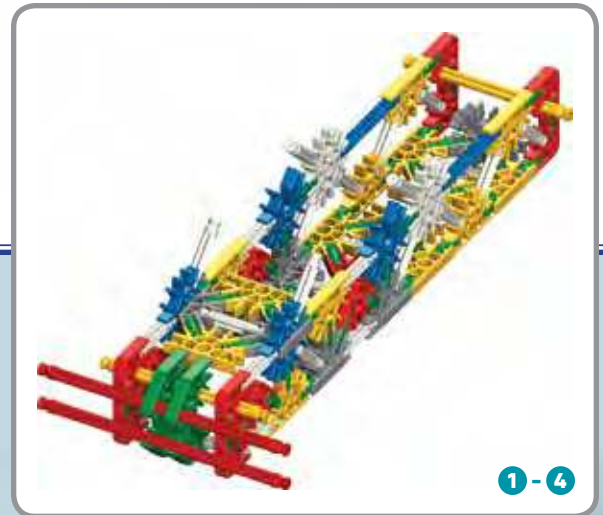
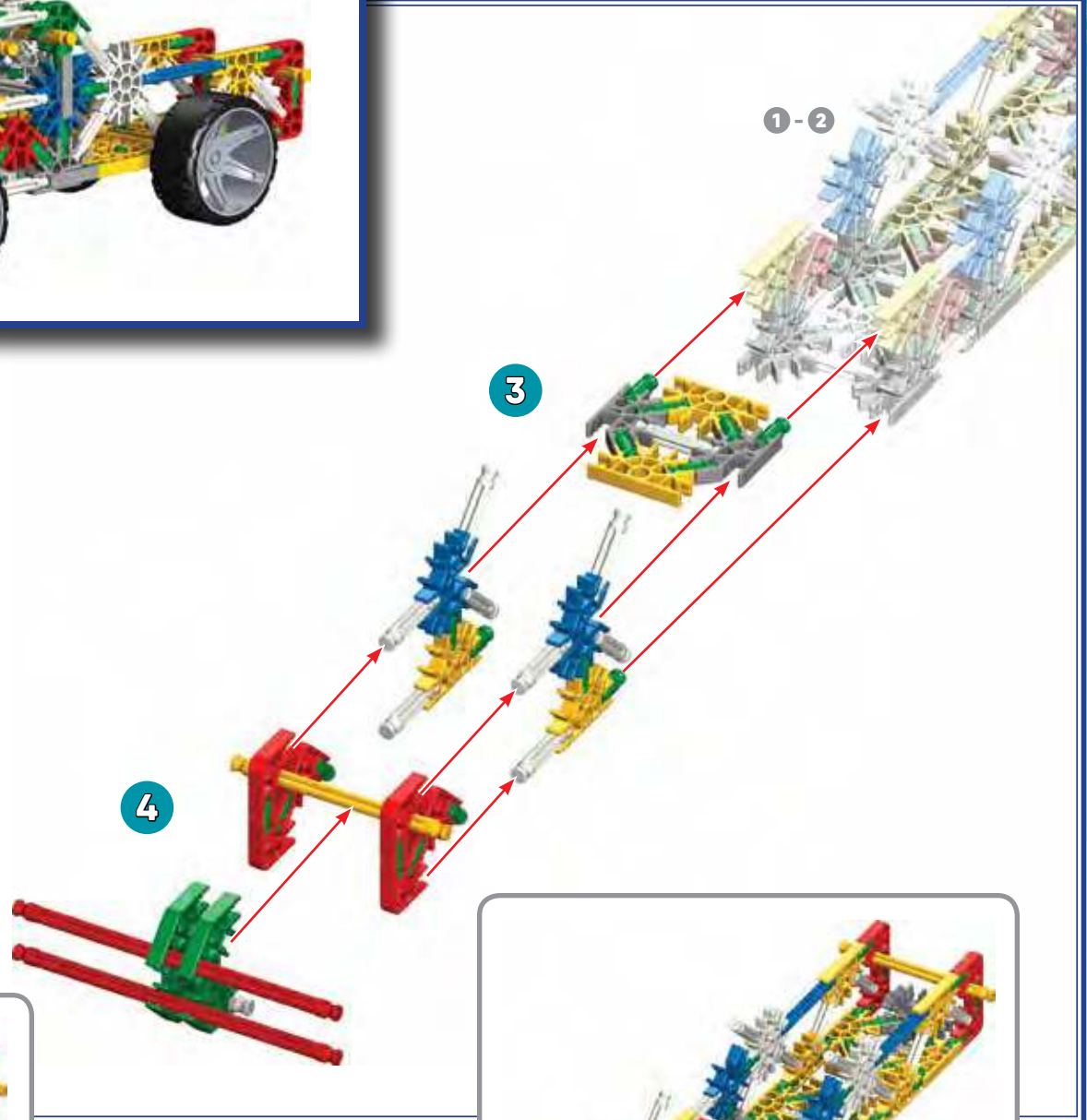
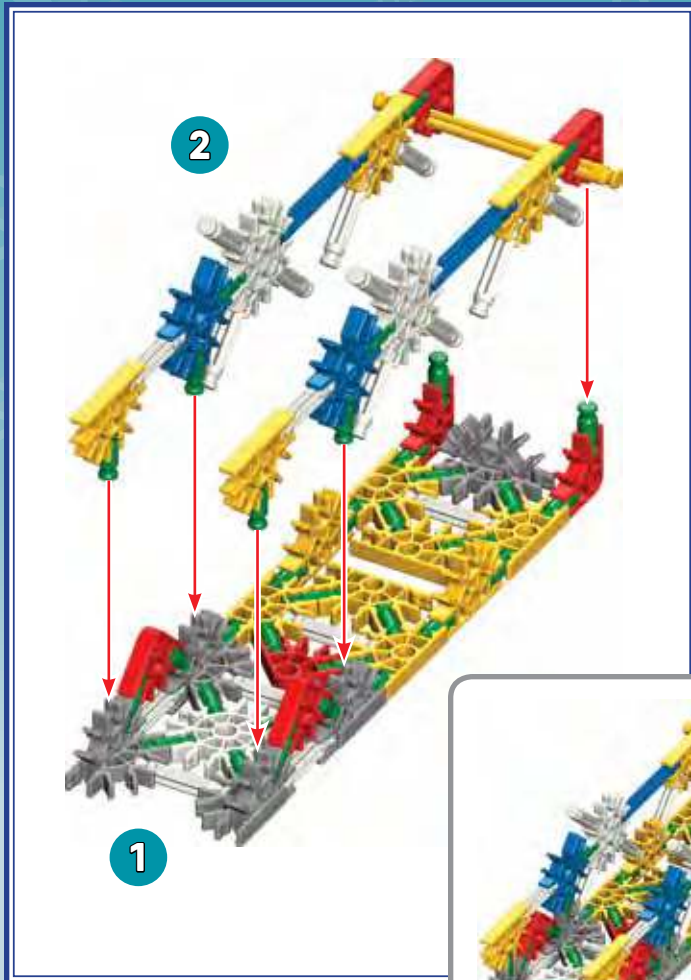

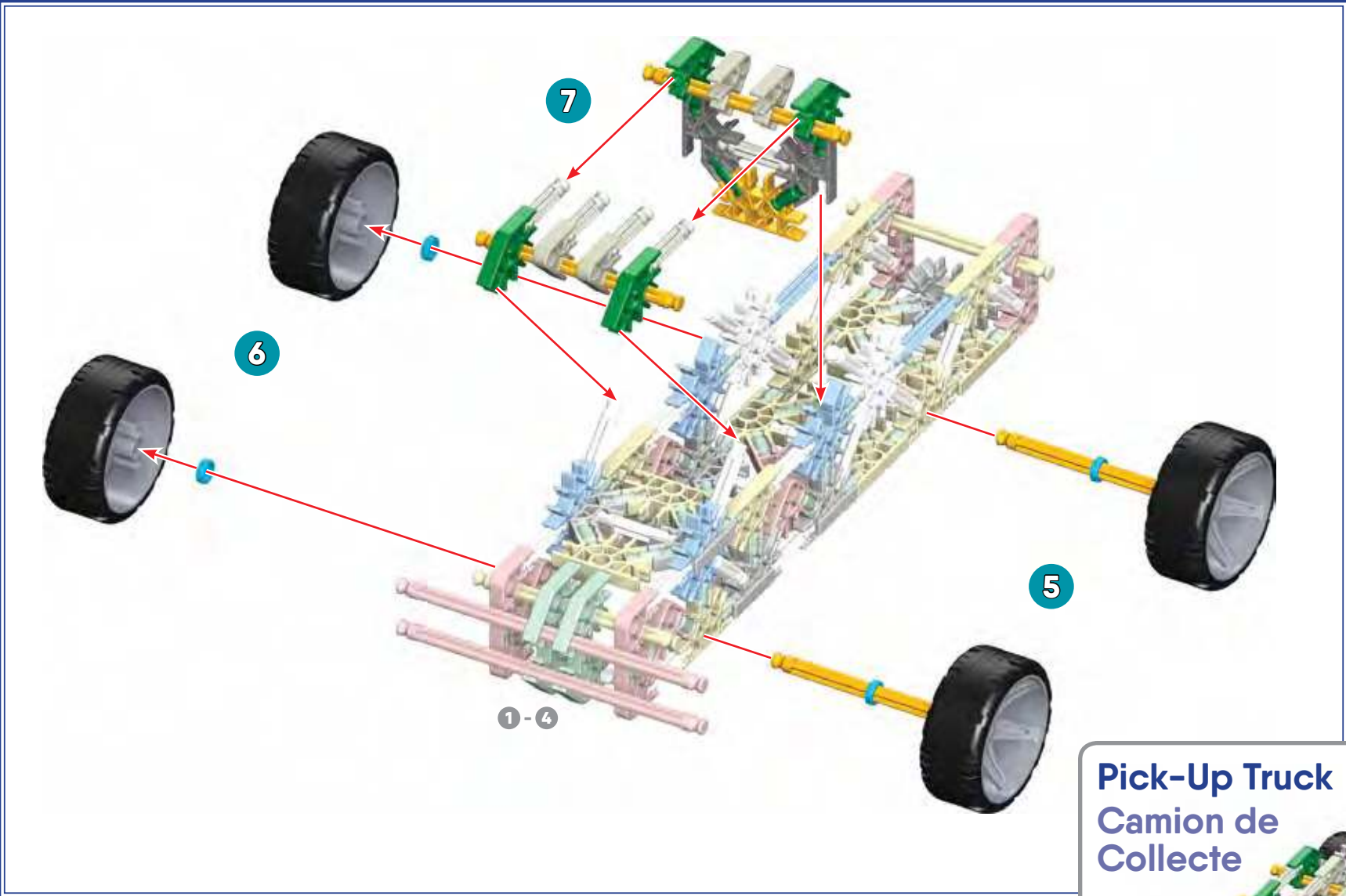

1-7

Four Wheeler Vehicule a quatre roues

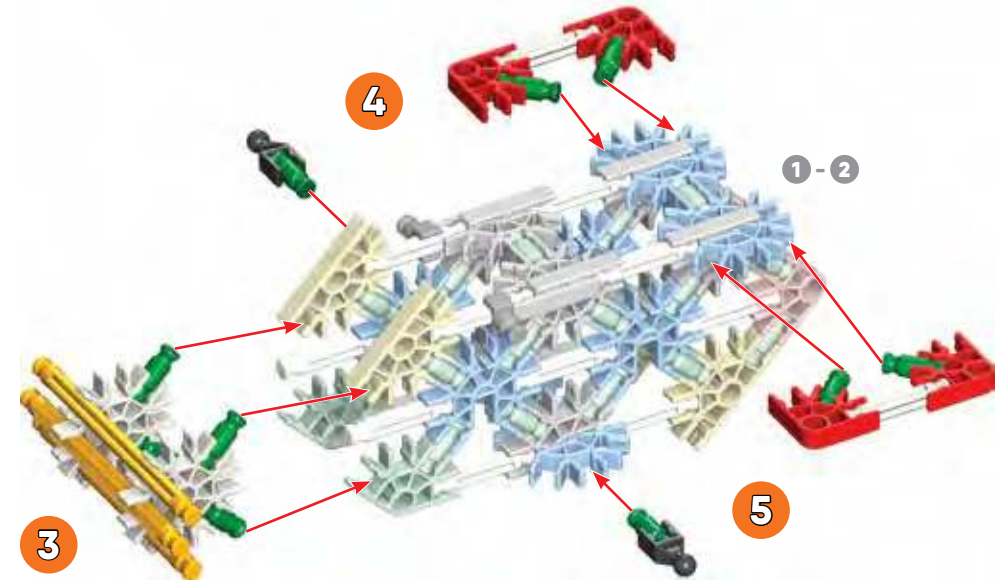
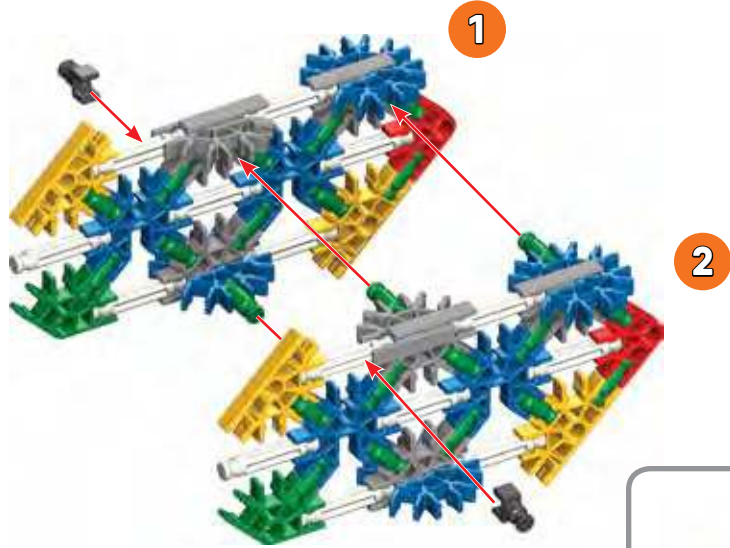

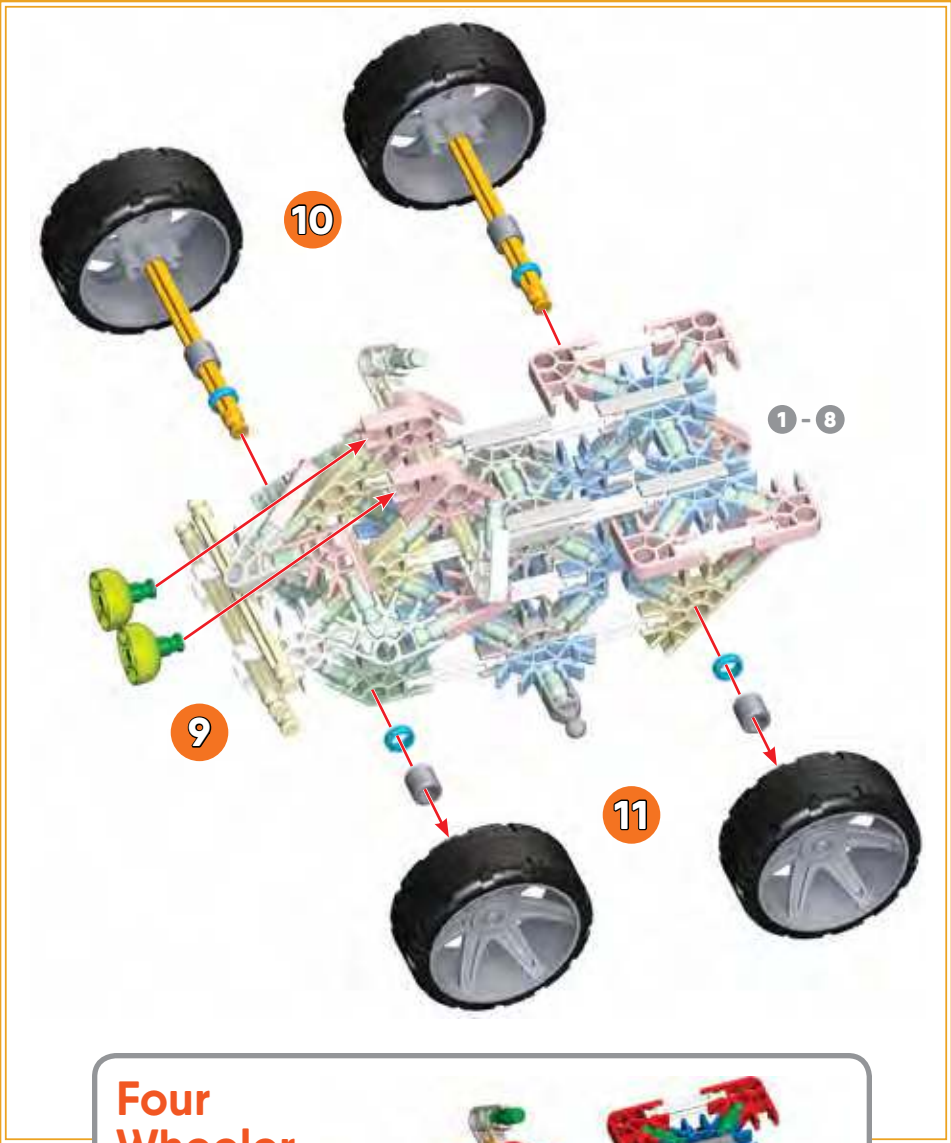
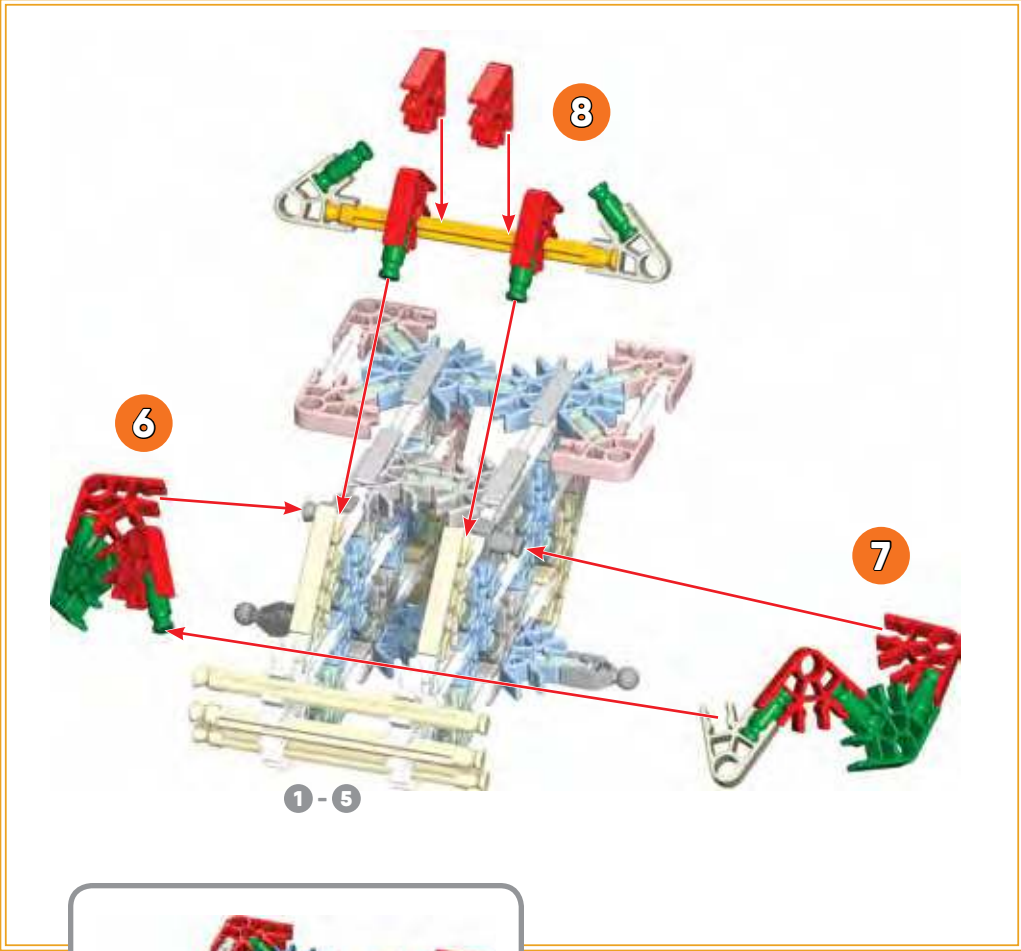

Megaphone

Porte-voix

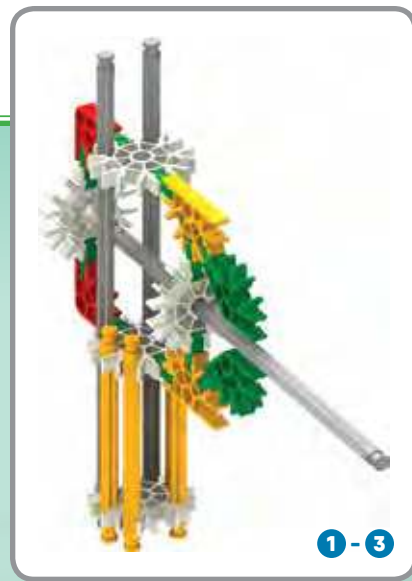
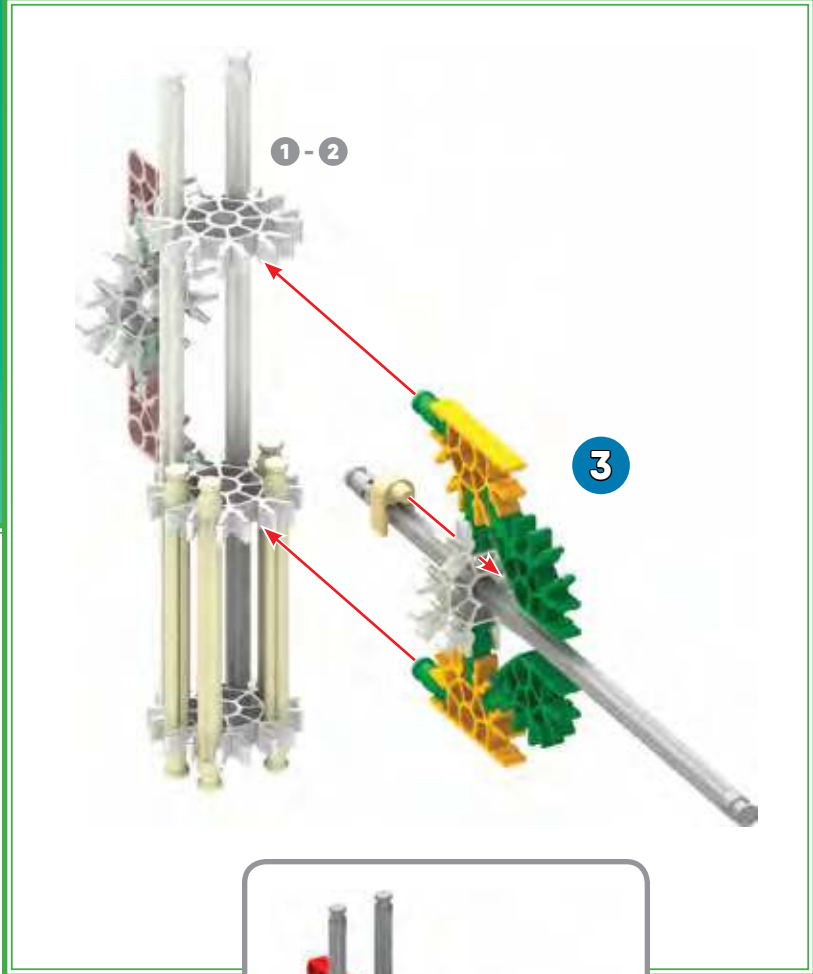
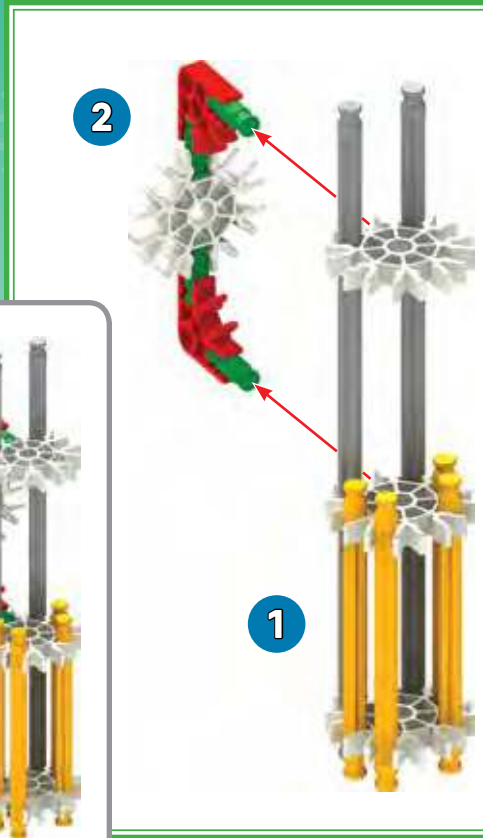
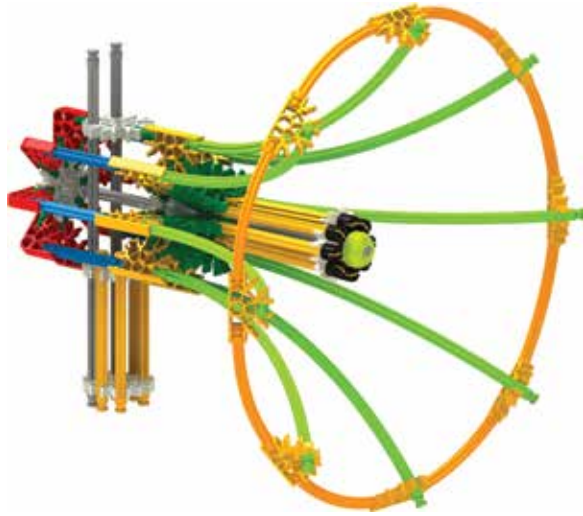

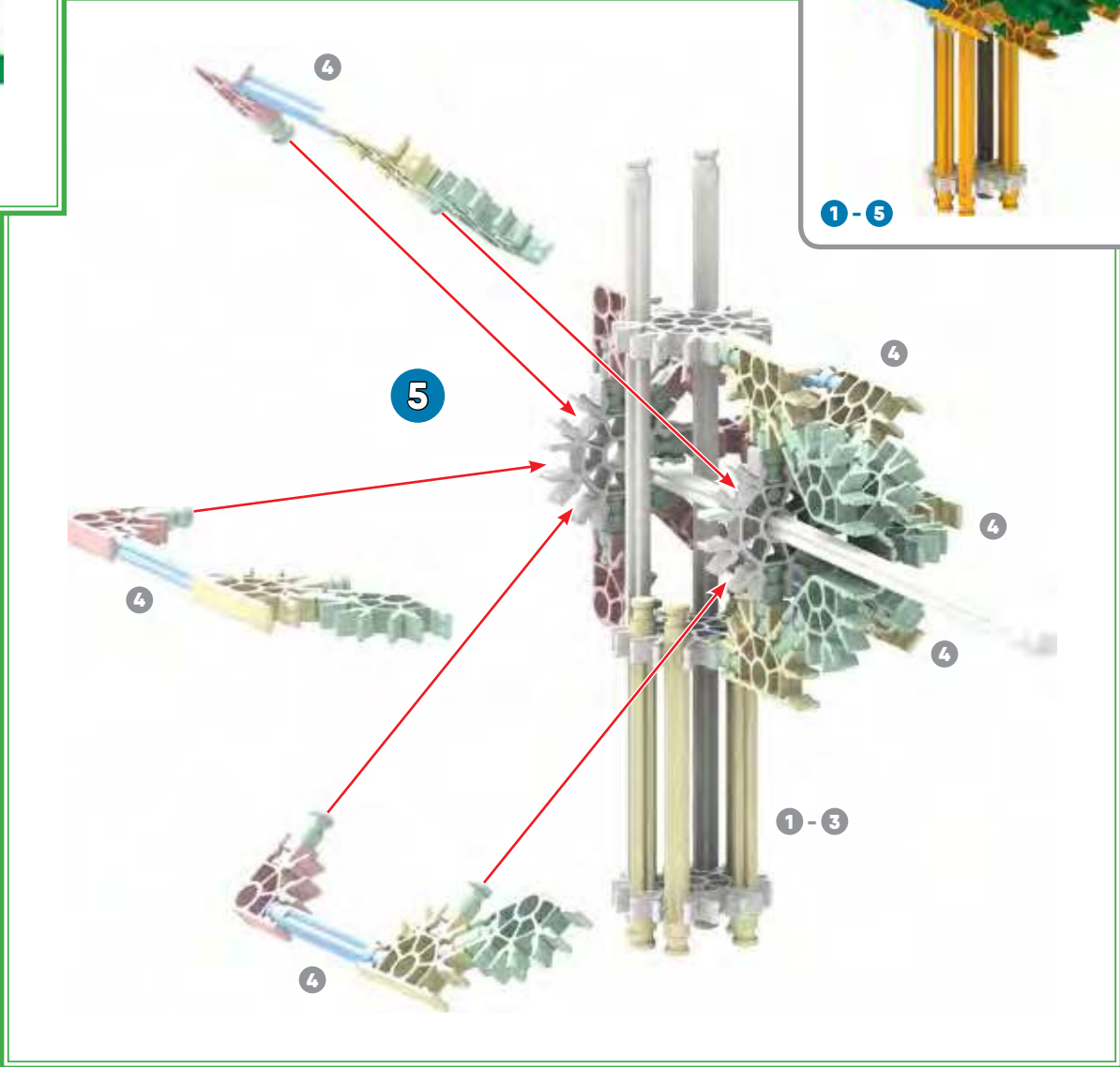
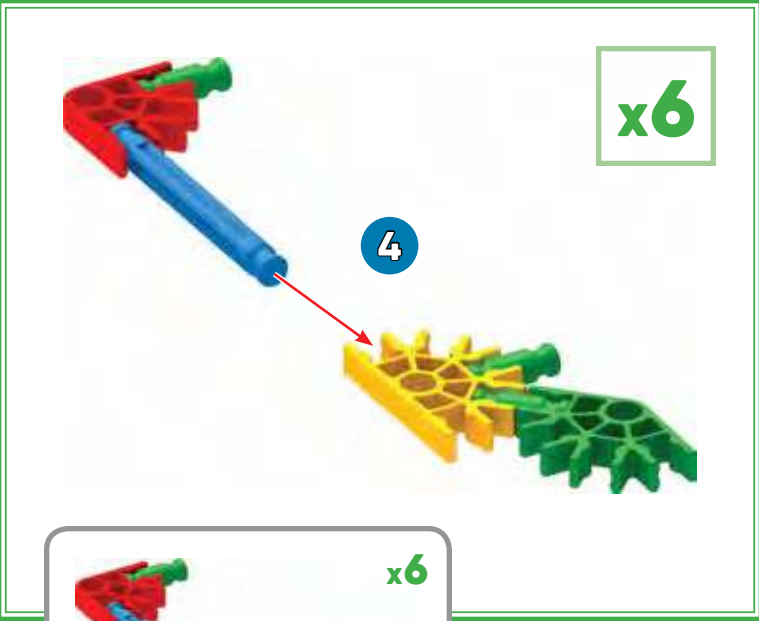

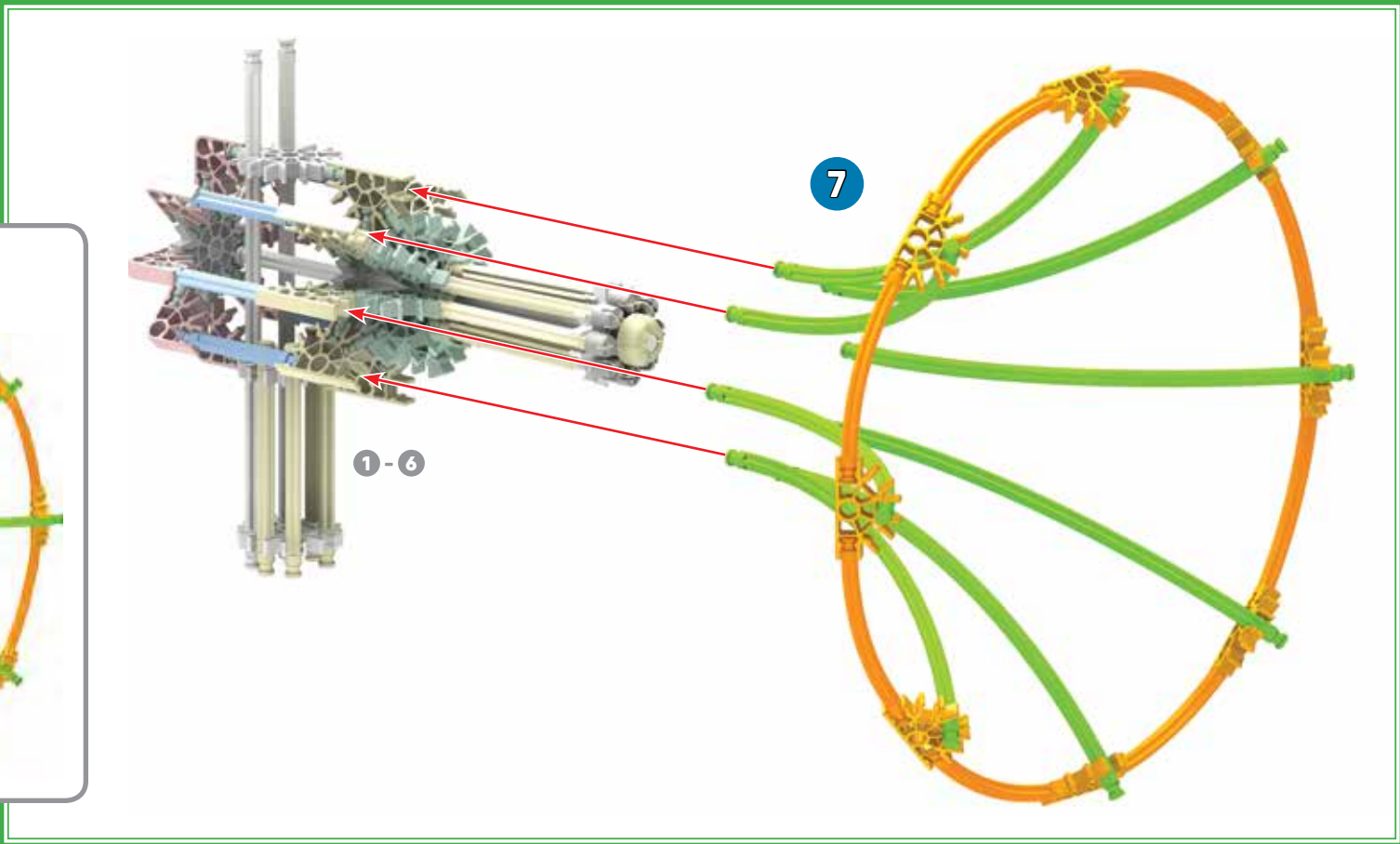
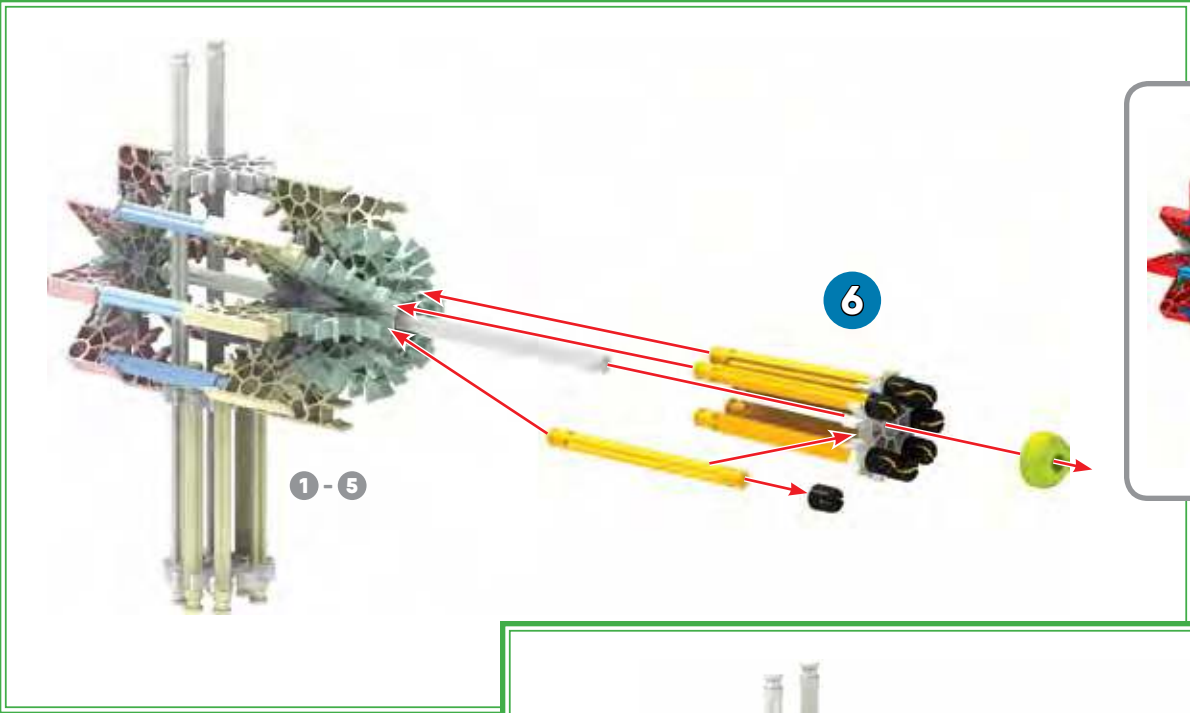

Camera Caméra

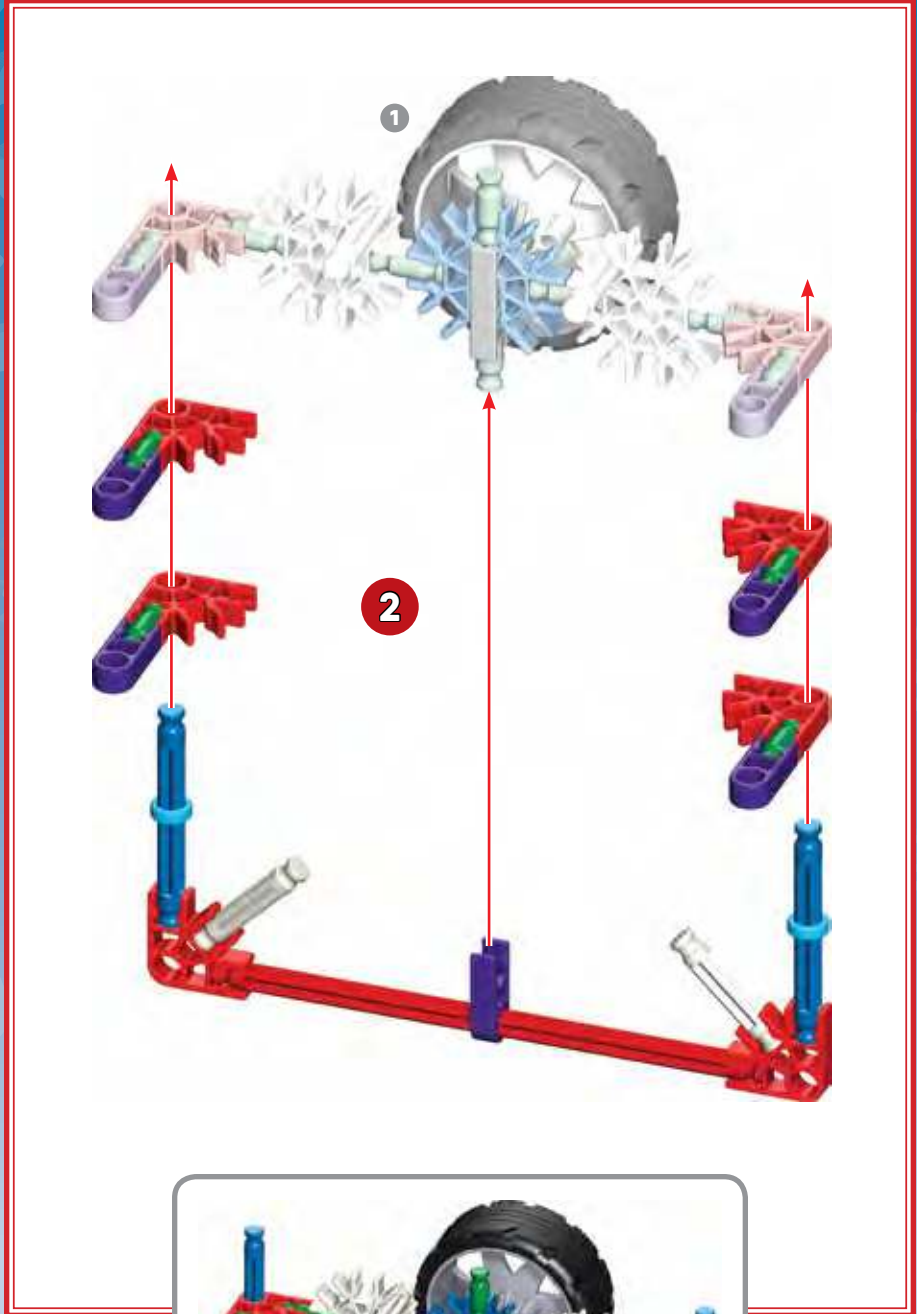
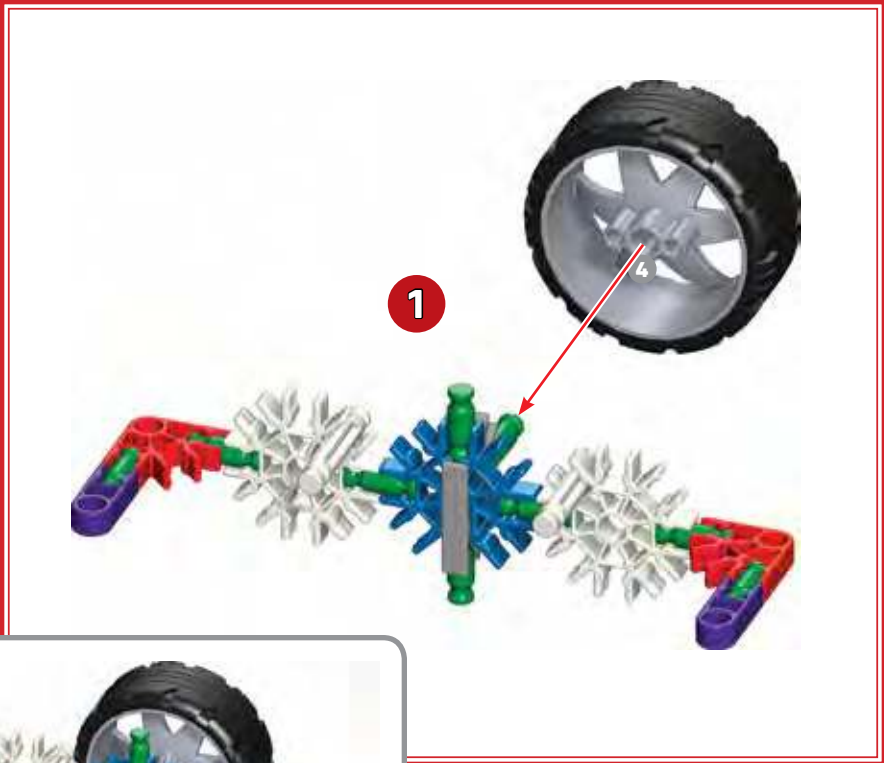
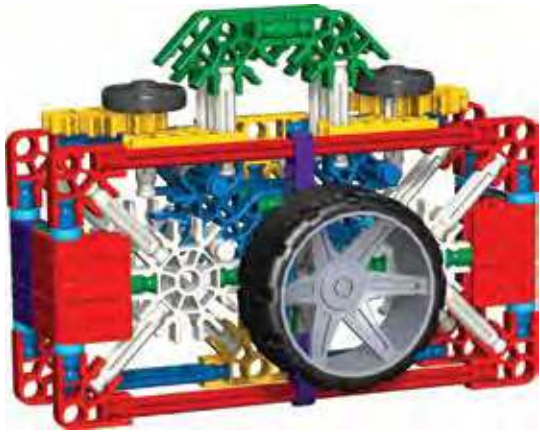

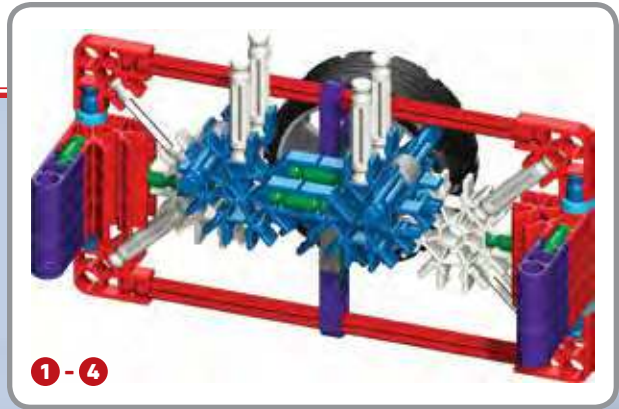
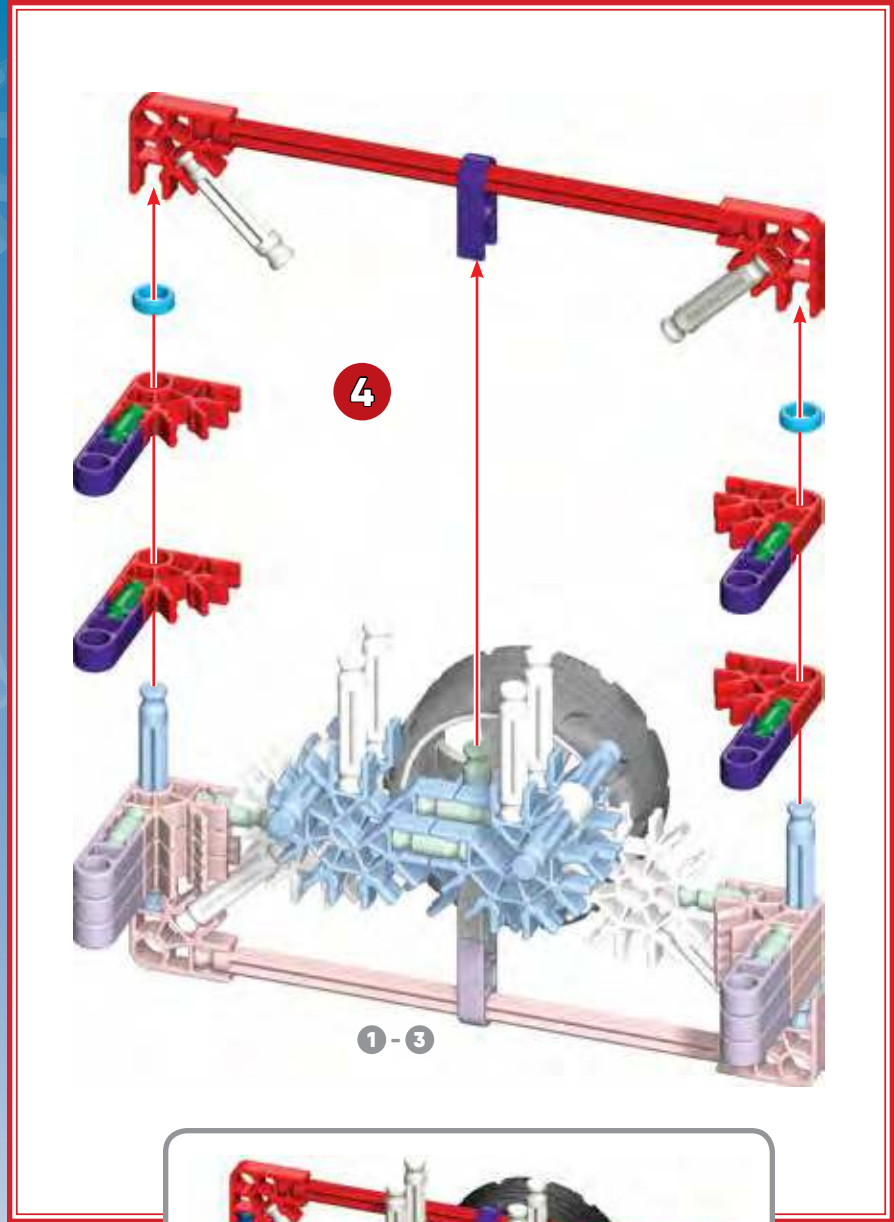
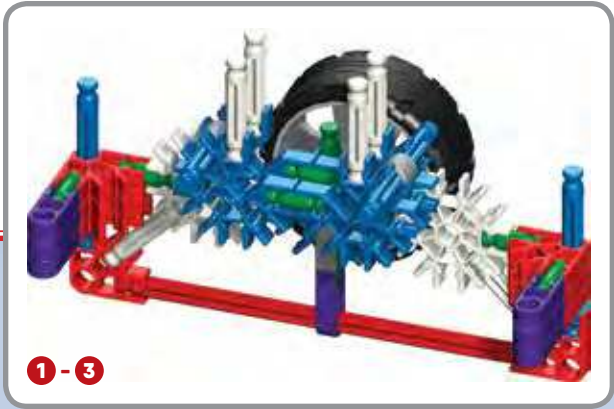
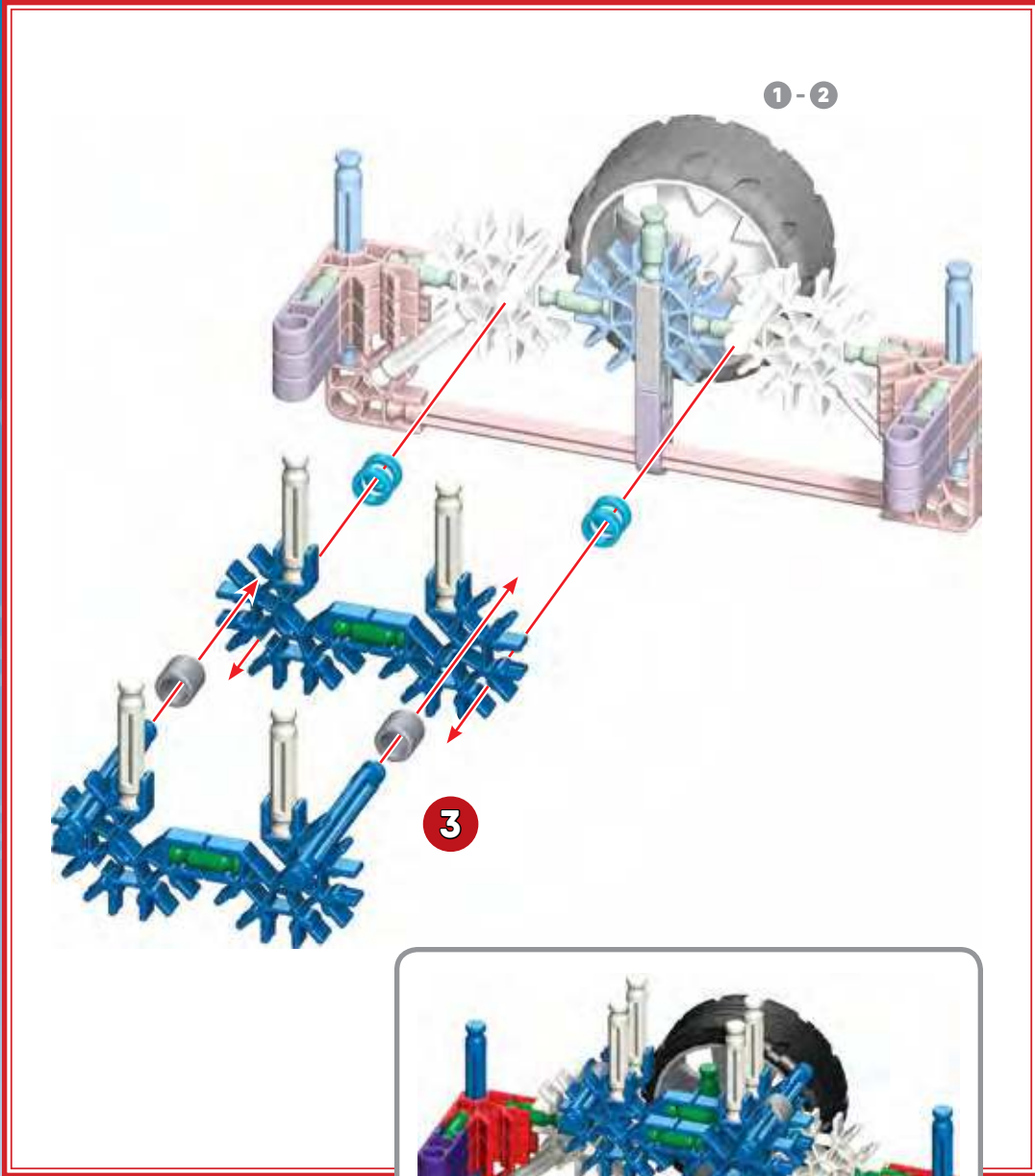

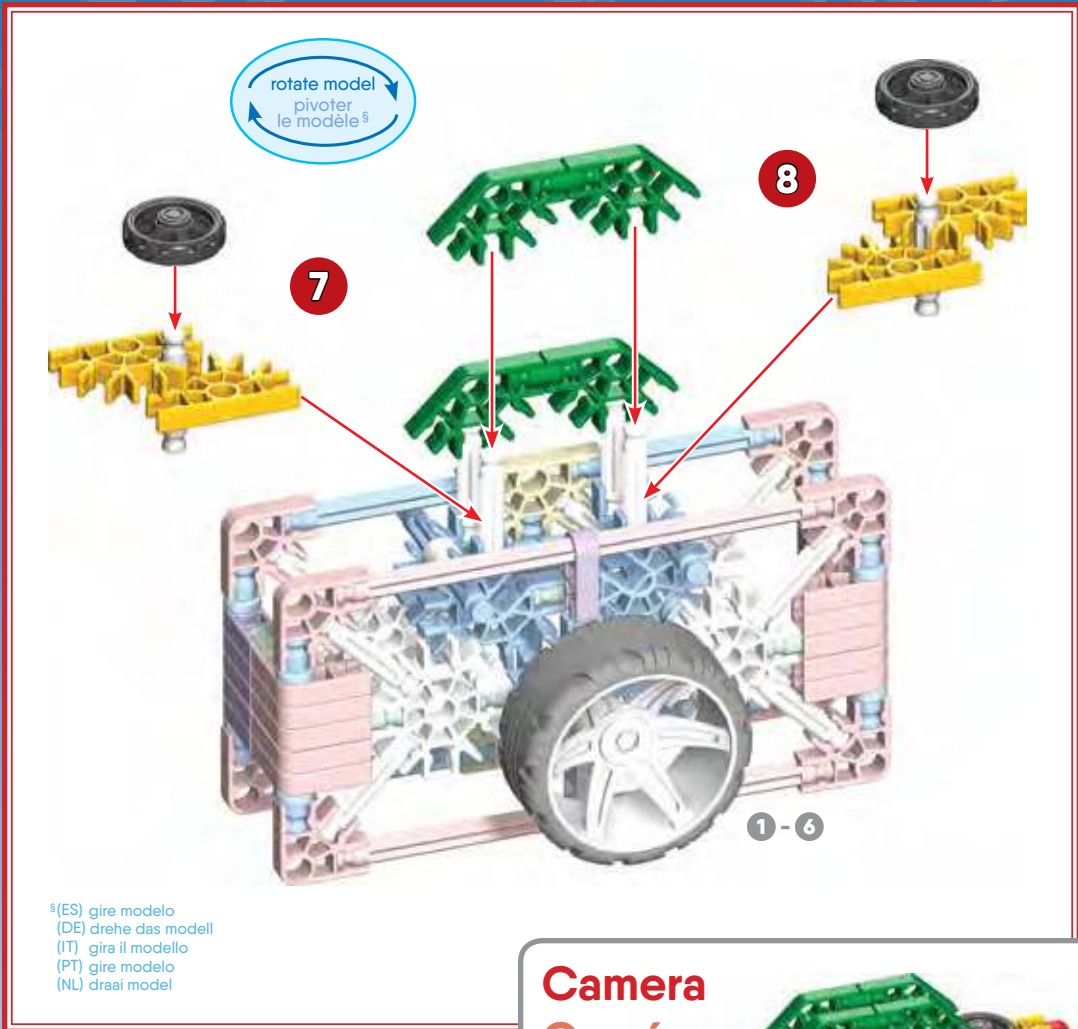
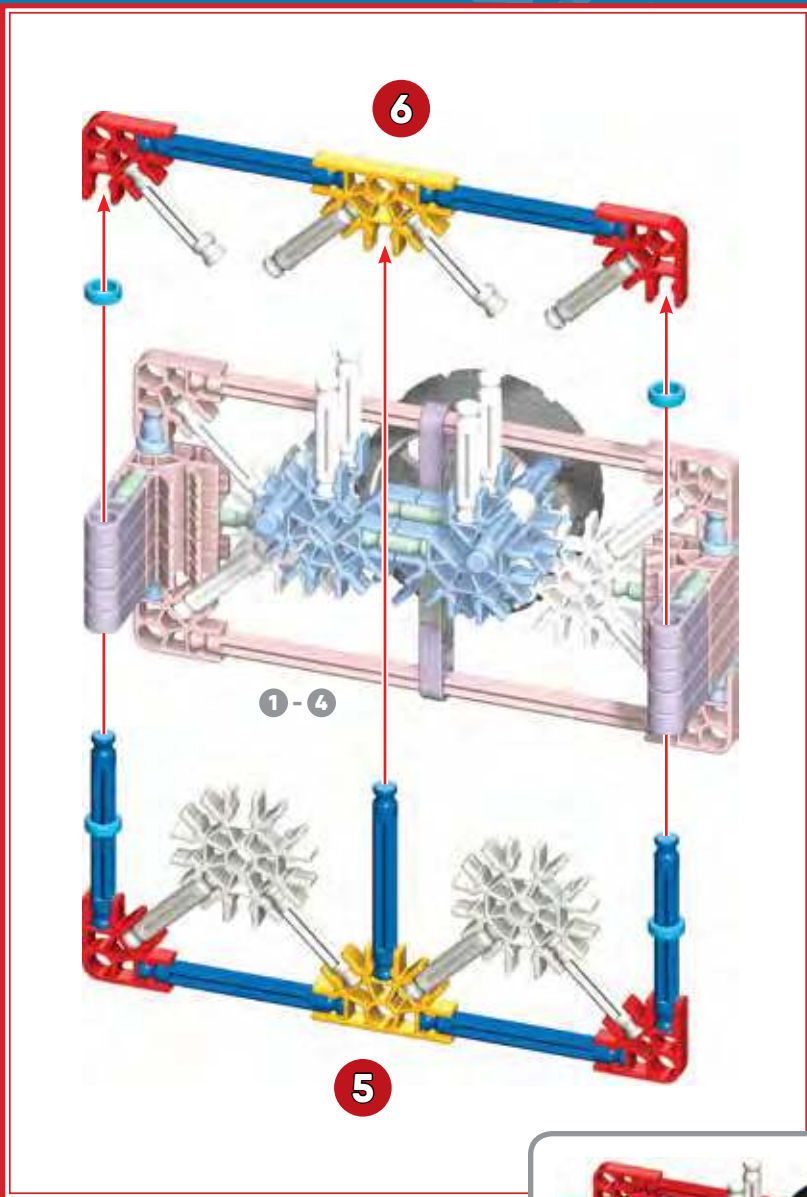

Waverunner Surfer

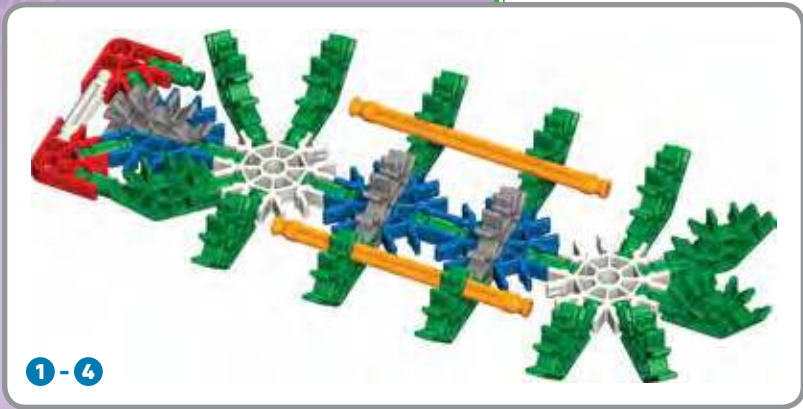
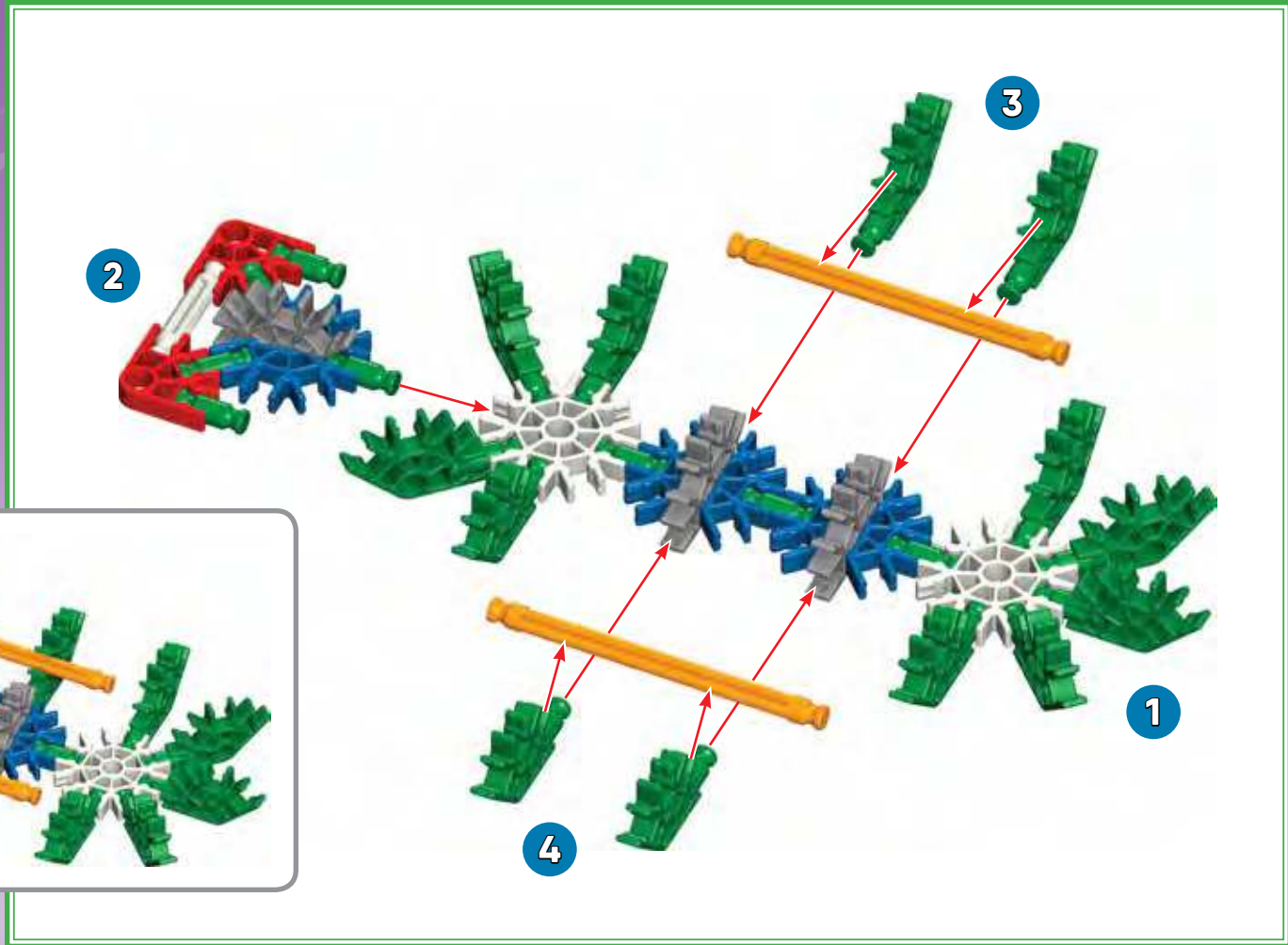

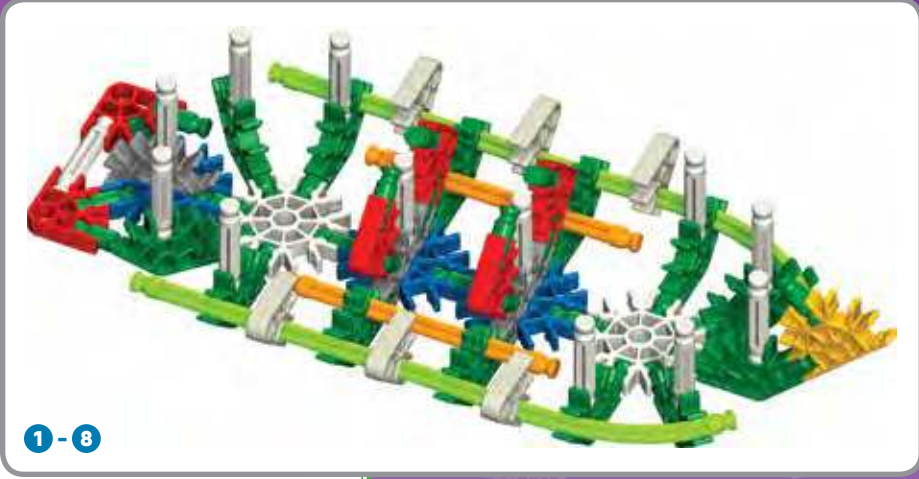
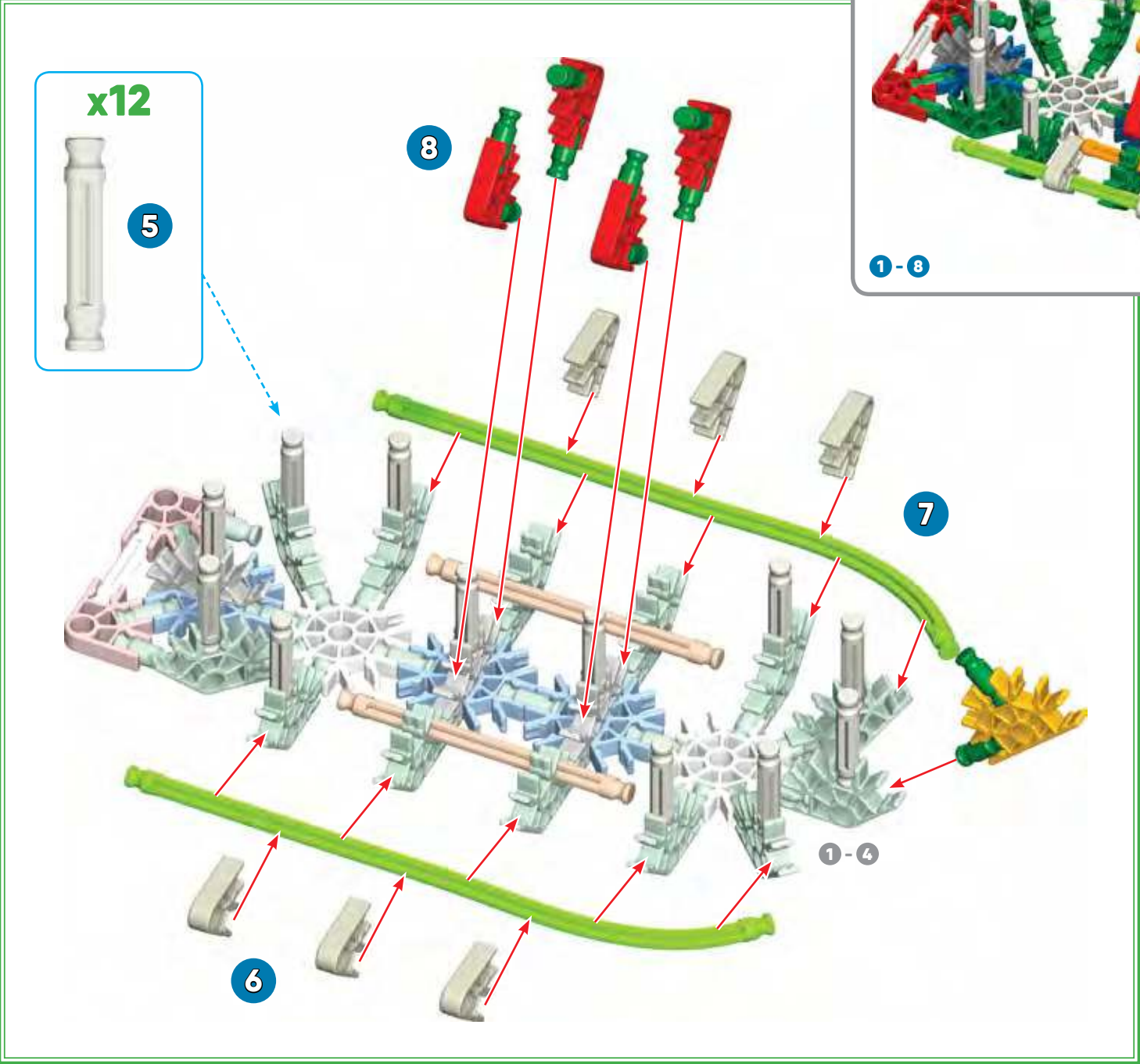

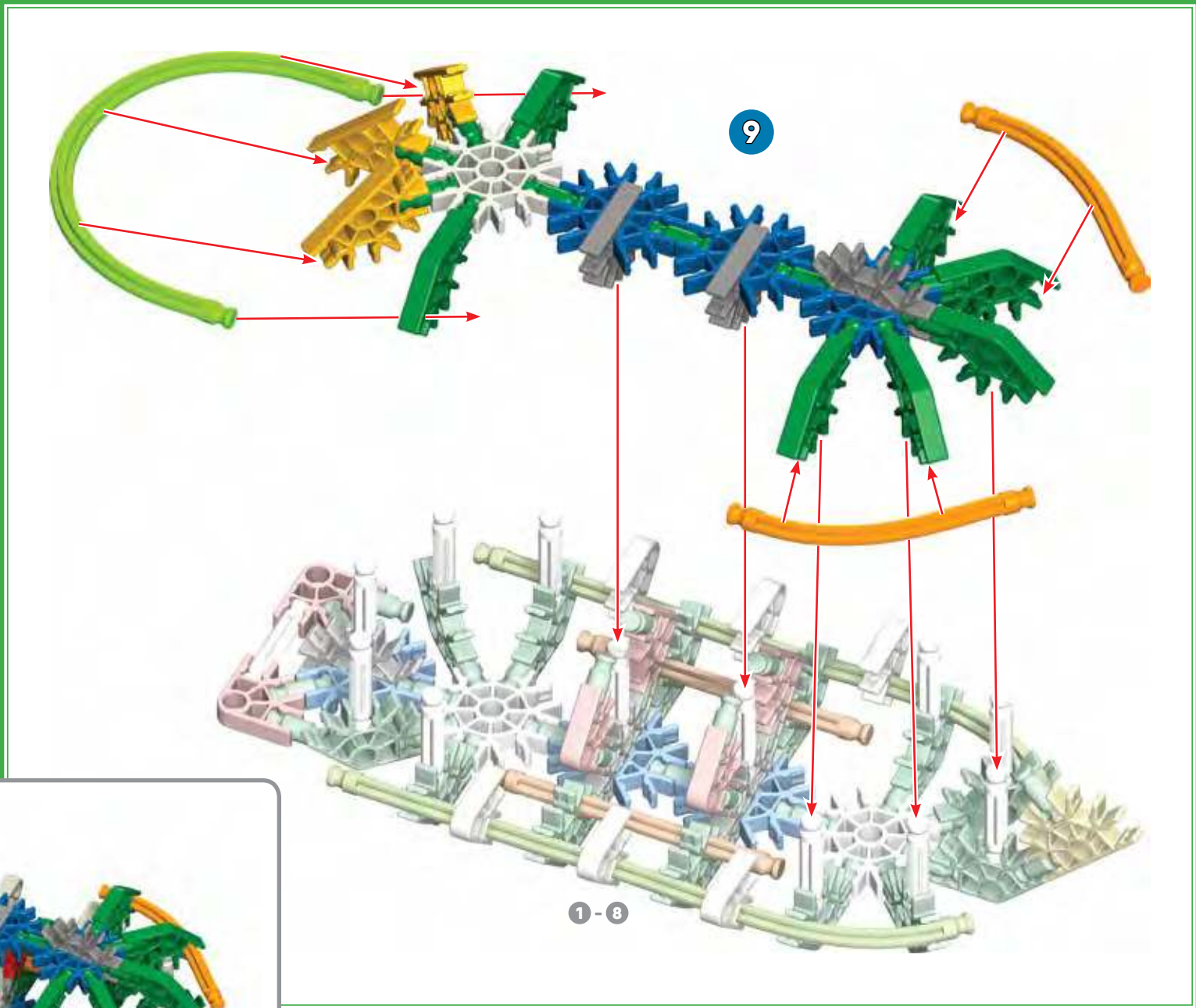

Waverunner Surfer



1-10

10

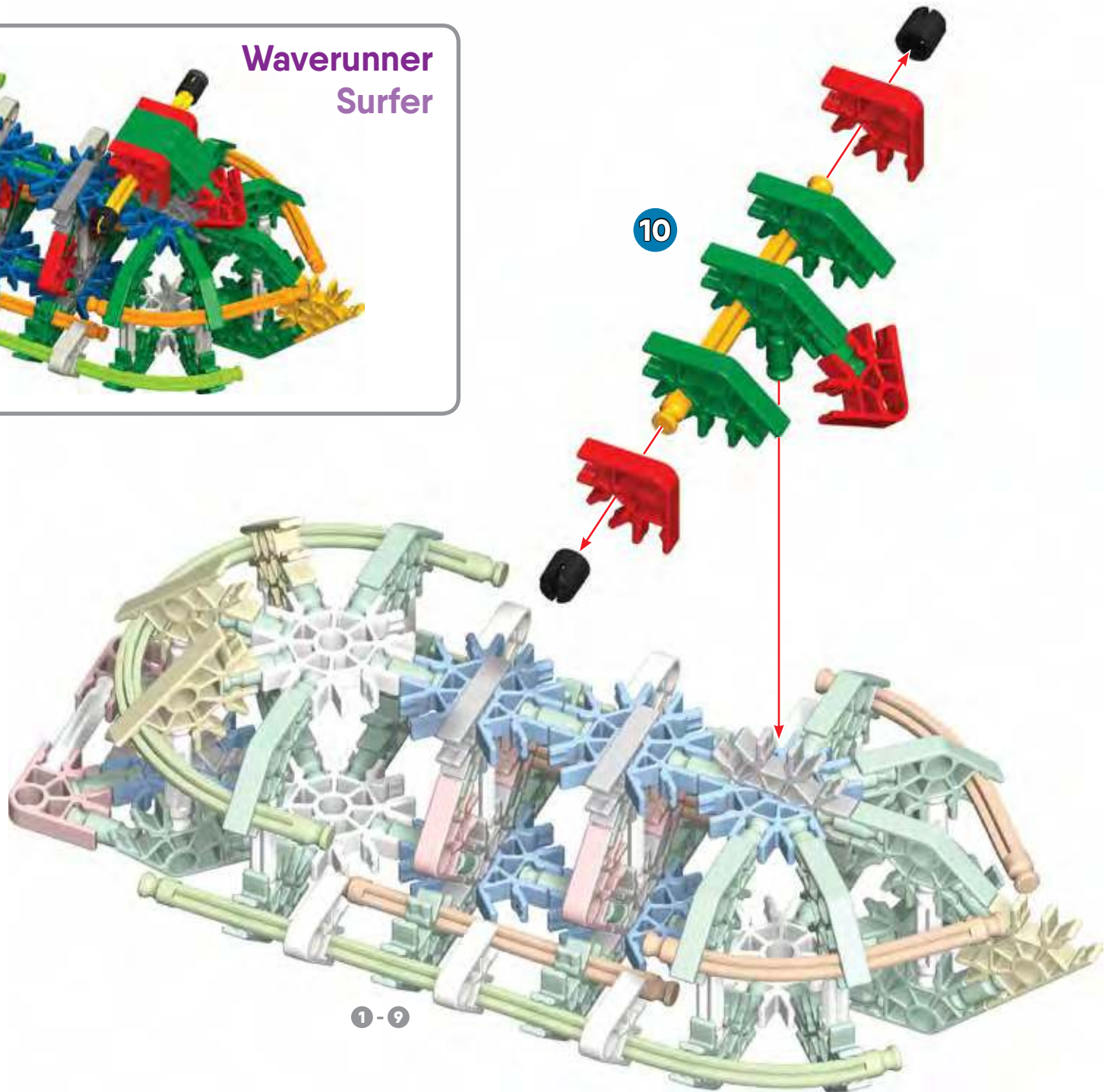

1-9

Muscle Car

Grosse Cylindree

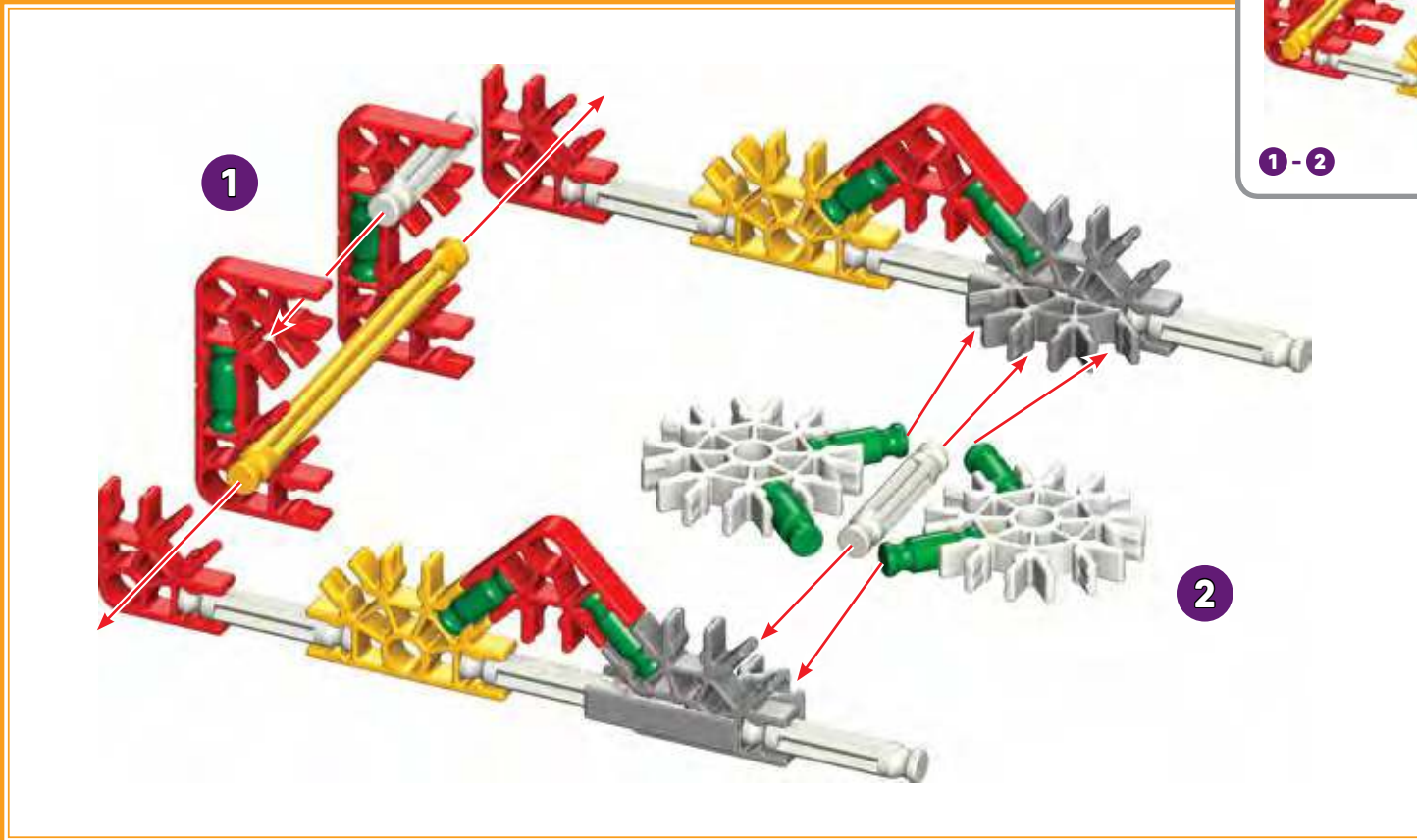
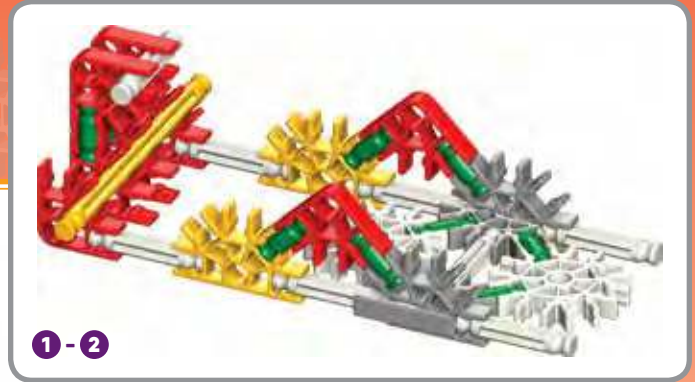

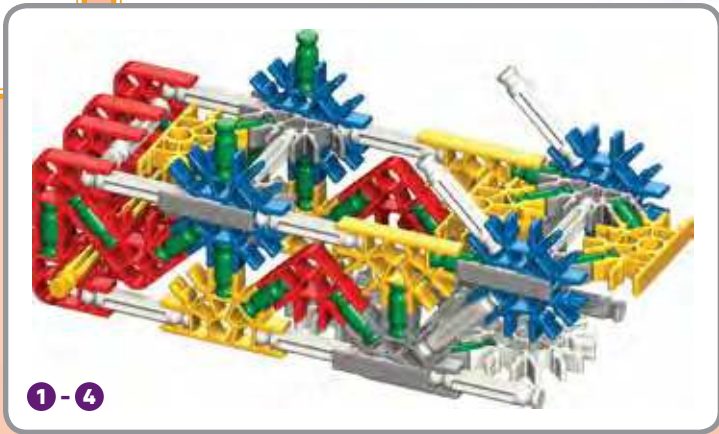
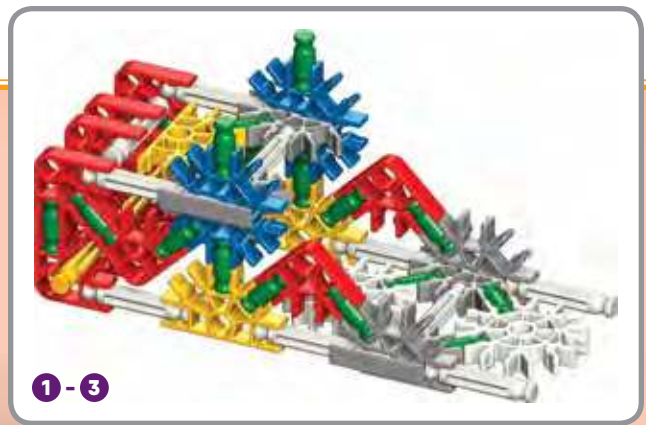
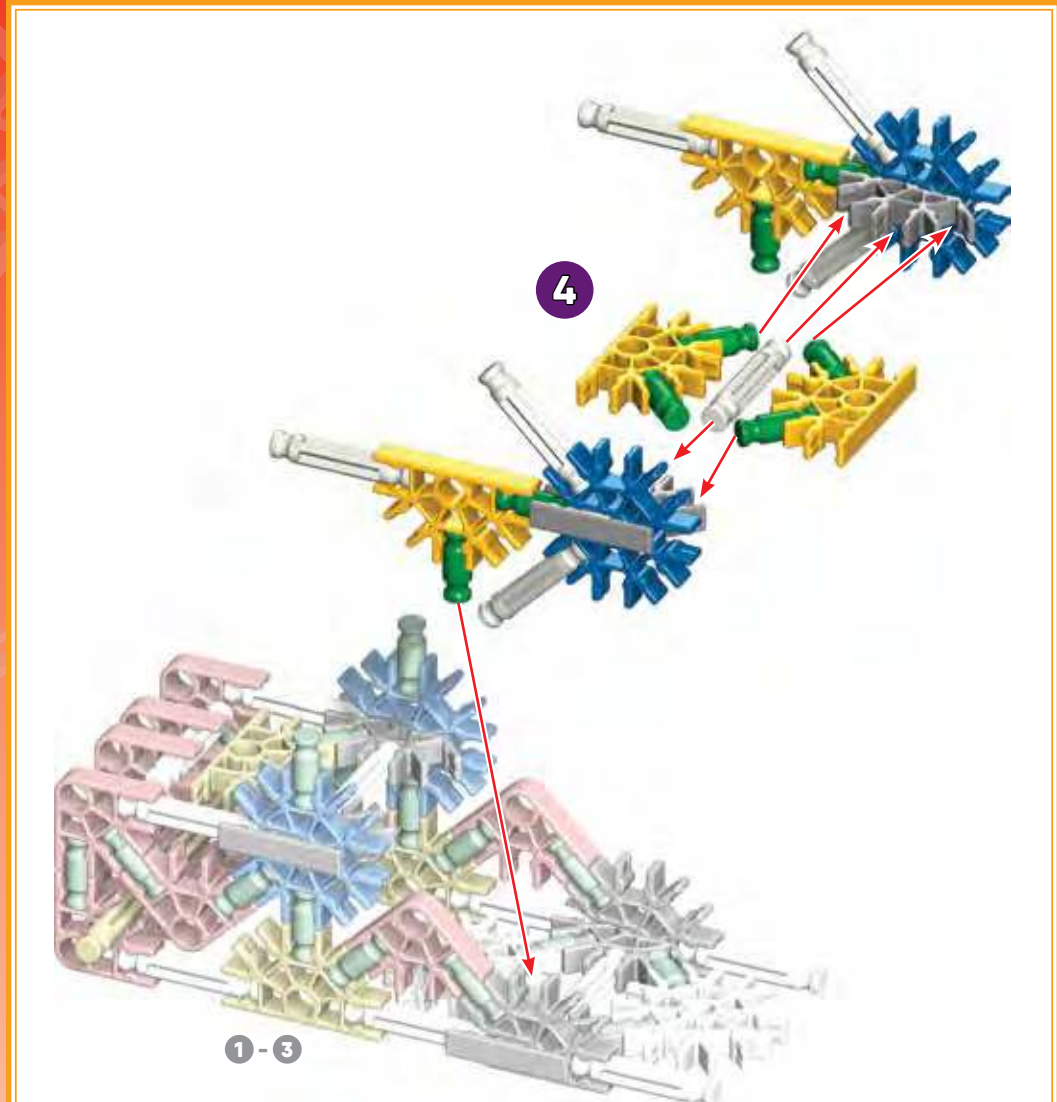
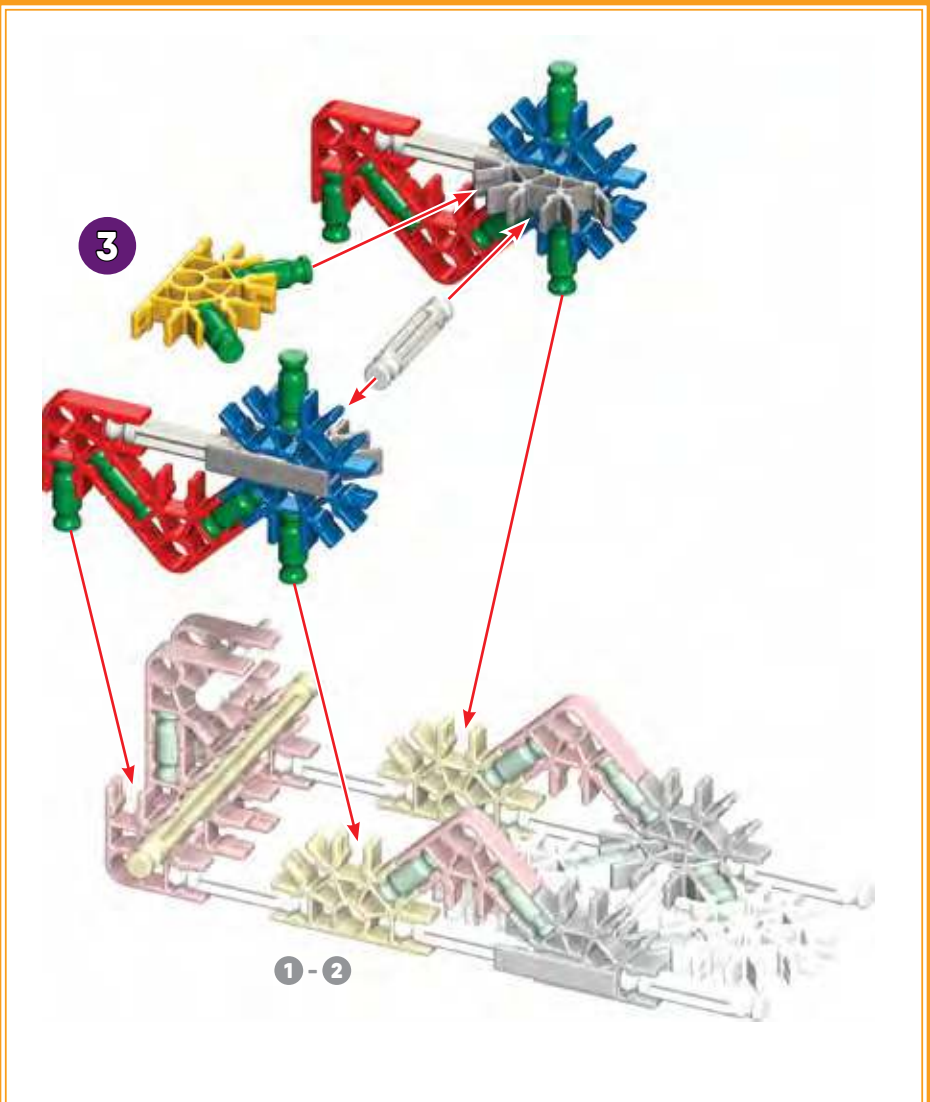

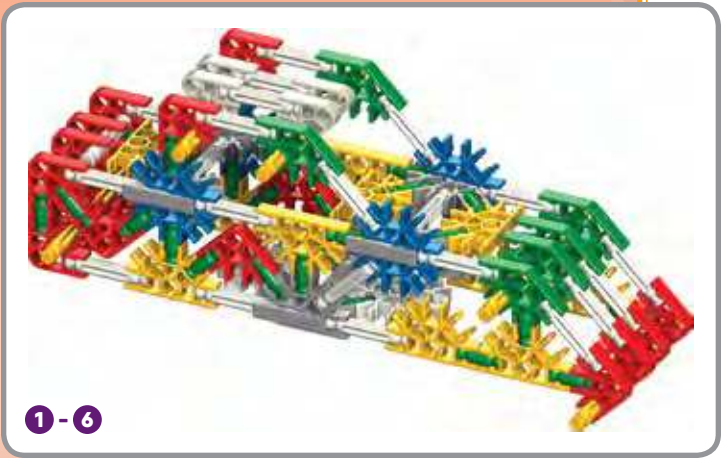
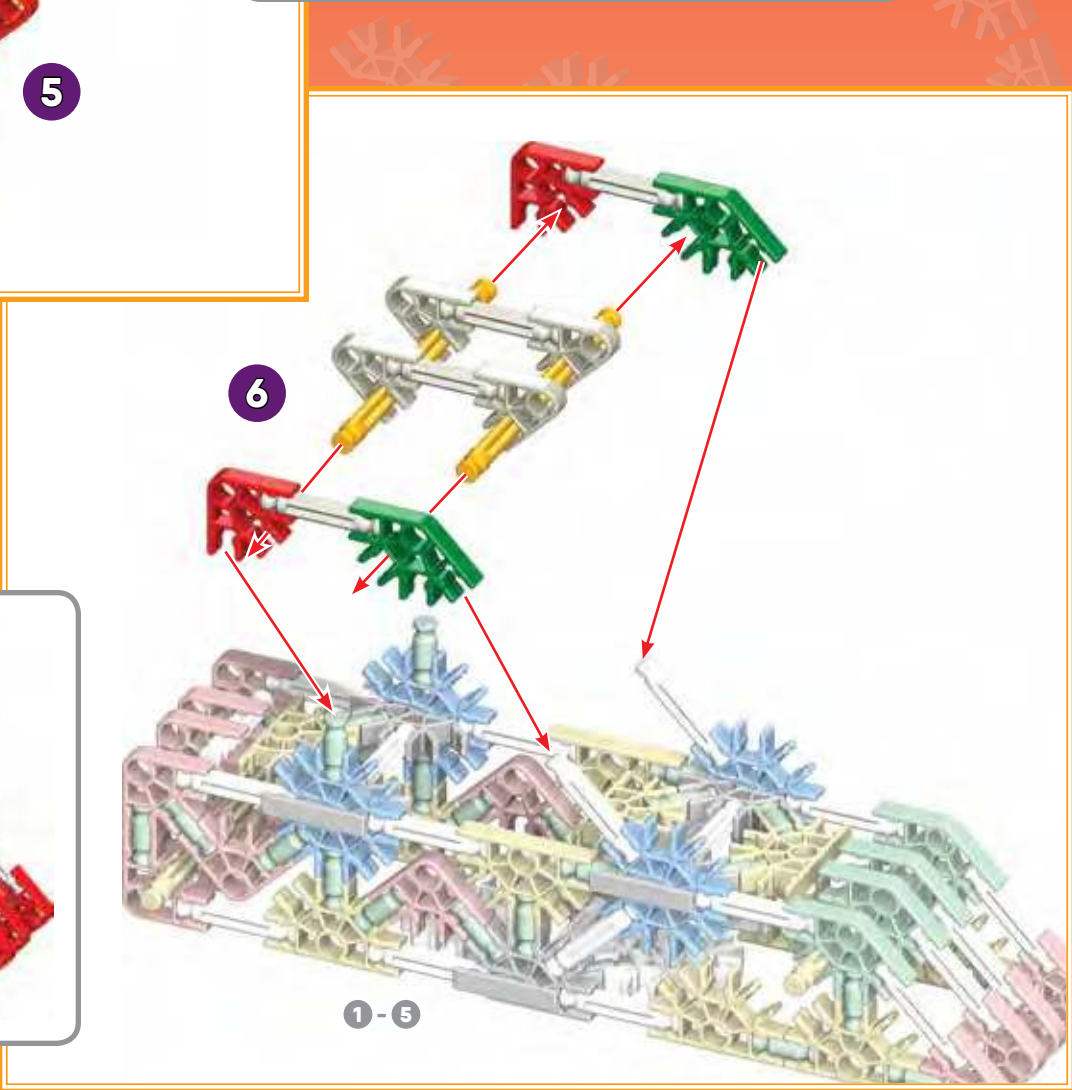
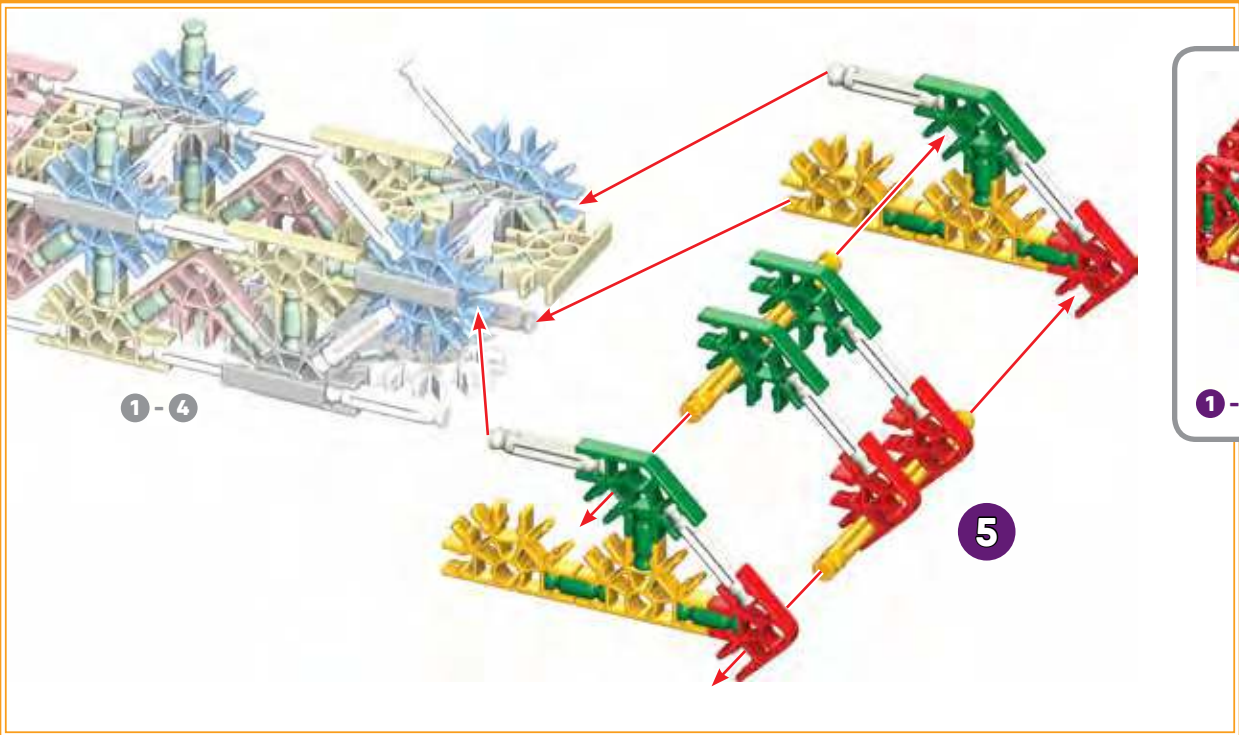

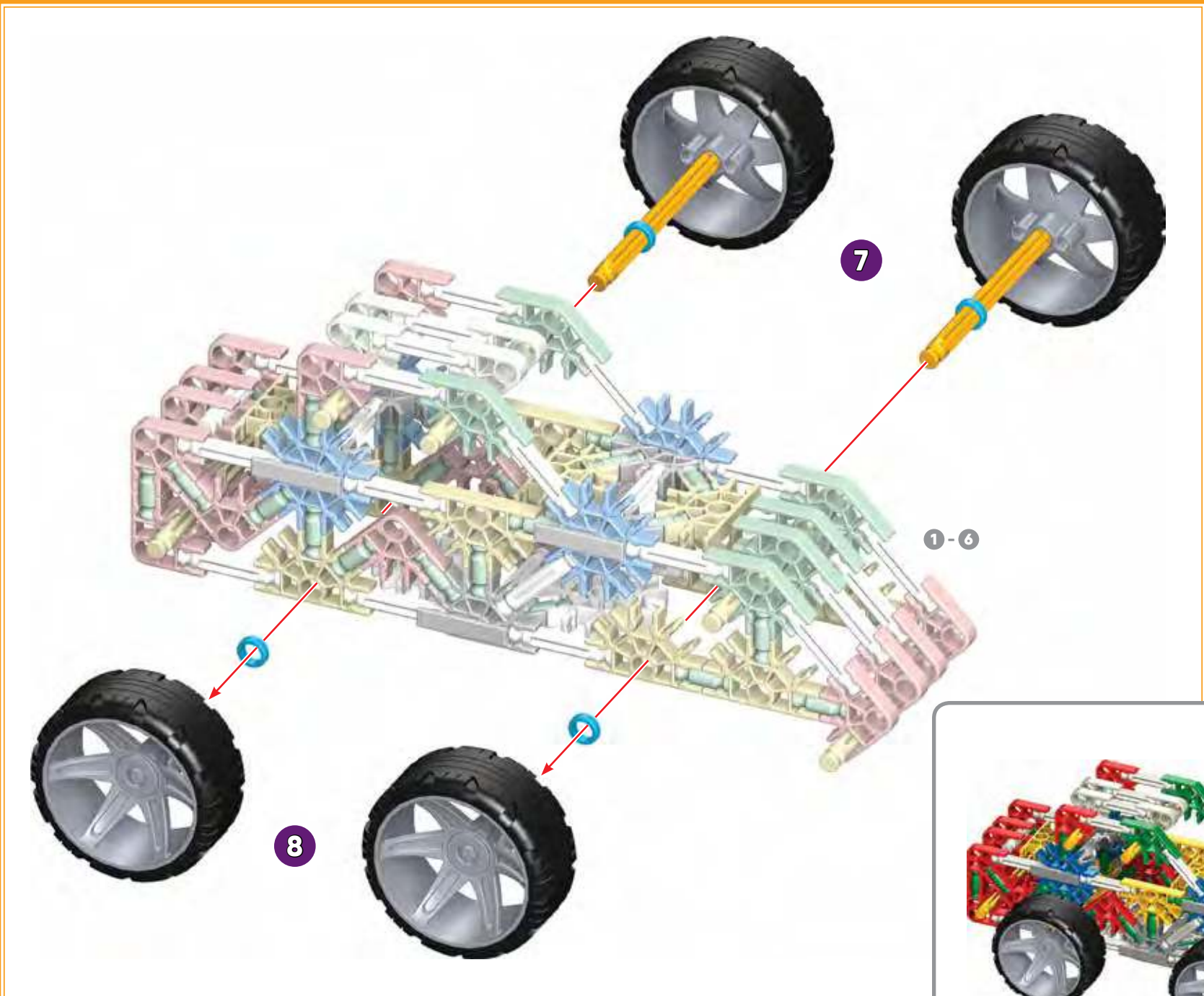

BUILDING IDEAS

For instructions of these models go to www.knex.com/instructions and enter code 17435.

IDÉES DE CONSTRUCTION

Pour les instructions de ces modèles vont à www.knex.com/instructions et entrez dans le code 17435.





BUILDING IDEAS

For instructions of these models go to www.knex.com/instructions and enter code **17435**.

IDÉES DE CONSTRUCTION

Pour les instructions de ces modèles vont à www.knex.com/instructions et entrez dans le code **17435**.

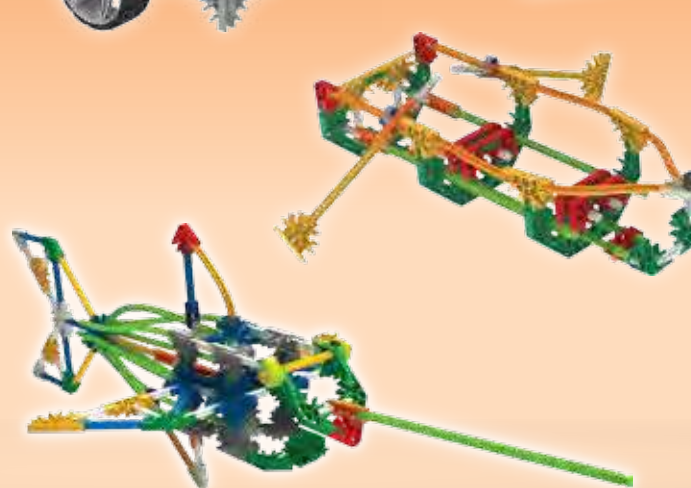
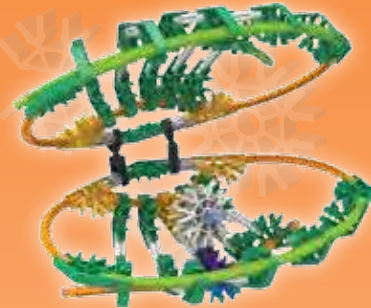
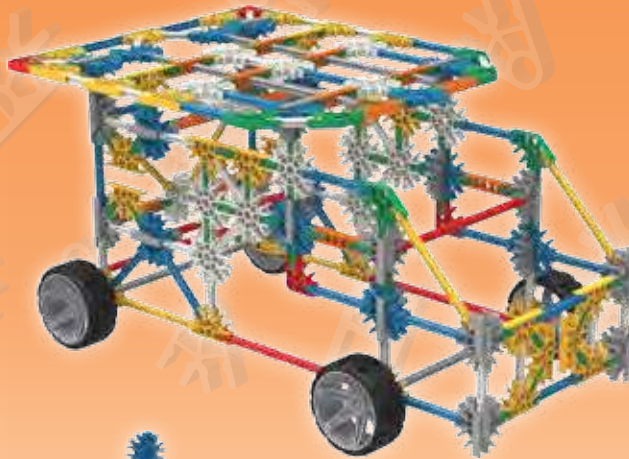



(ES) Español

(Página 2)

Lista de piezas

Antes de comenzar a construir, compare las piezas de su juego con las que se enumeran aquí. Si falta algo, llámenos o escribanos utilizando la información que se encuentra en el reverso. ¡Estamos aquí para ayudarle!

Esenciales de construcción K'NEX

Para comenzar a construir

Para comenzar el modelo, encuentre el número 1 del paso y siga los números. Cada pieza tiene su propia forma y color. Observe las imágenes, encuentre las piezas que sean iguales a las que se muestran y conéctelas. Colocar el modelo en la misma dirección que se encuentra en las instrucciones le facilitará la construcción. Las flechas muestran en dónde se conectan las piezas, pero no todos los puntos de conexión tienen flechas. Las partes de color tenue son las que ya armó.

Separadores

Hay lugares en su modelo donde usted necesita utilizar espaciadores. Asegúrese de usar el color correcto y el número de espaciadores que se muestra en las instrucciones.

Conectores

Usted puede deslizar estos conectores especiales juntos. Empuje firmemente hasta que oiga un "clic". Preste atención a las instrucciones y la posición horizontal o verticalmente, exactamente como se muestran.

Varillas flexibles

Una Varilla Flexible es una Varilla que se puede doblar para formar curvas. Serán más fáciles de conectar a tu modelo si primero las doblas hacia atrás y hacia adelante.

(Página 34, 36)

IDEAS DE CONSTRUCCIÓN

Para obtener instrucciones de los estos modelos vaya a www.knex.com/instructions y entre en el código 17435.

(DE) Deutsch

(Seite 2)

Teileliste

Bevor du mit dem Bauen anfängst, solltest du prüfen ob die Teile in deinem Bausatz mit denen auf dieser Teileliste übereinstimmen. Falls etwas fehlt, rufe uns an oder schreibe uns (siehe Rückseite). Wir sind für dich da!

Grundlegende Bauanleitungen für K'NEX

Los geht's mit dem Bauen

Um mit dem Bauen deines Modells zu beginnen, suche die Nummer 1 und folge den laufenden Nummern. Jedes Teil hat seine eigene Form und Farbe. Schau dir einfach die Abbildungen an, such

die Teile in deinem Bausatz, die so aussehen wie das, was du auf der Abbildung siehst und steck sie ineinander. Versuche, dein Modell beim Zusammenbauen so zu orientieren, dass es in die gleiche Richtung weist, wie es in den Anleitungen beschrieben und gezeigt wird. Blasser Farben weisen darauf hin, dass dieser Streckenabschnitt bereits zusammengebaut ist.

Abstandsstücke

An manchen Stellen in deinem Modell musst du Abstandsstücke einbauen. Achte darauf, die richtige Farbe und Anzahl von Abstandsstücken wie in der Anleitung gezeigt zu verwenden.

Verbindungsstücke

Verbindungsstücke haben besonders lange Schlitze. Wie du auf der Abbildung sehen kannst, lassen sie sich ineinander schieben. Achte beim Aneinanderfügen dieser Teile darauf, dass du ein Klickgeräusch hörst. Erst dann sind die Teile fest miteinander verbunden.

Flexi-Laschen

Eine Flexi-Lasche ist eine Lasche, die du zu einer Kurve zurechtbiegen kannst. Sie lassen sich leichter an dein Modell anschließen, wenn du sie mehrmals hin- und herbiegst, um sie flexibler zu machen, bevor du sie das erste Mal benutzt.

(Seite 34, 36)

BAUVORSCHLÄGE

Für Anweisungen dieser Modelle gehen sie zu www.knex.com/instructions und geben sie Code 17435 ein.

(IT) Italiano

(Pagina 2)

Elenco delle parti

Prima di cominciare a costruire, accertati di confrontare le parti che sono nel tuo set con l'elenco delle parti qui. Se ne manca una chiamaci o scrivici usando le informazioni che sono nella retrocopertina. Noi siamo qui per aiutarvi!

Istruzioni di base per costruire con K'NEX

Comincia a costruire

Per iniziare il modello, cerca il numero 1 e segui i numeri. Ogni pezzo ha una sua forma e un suo colore. Guarda la figura, trova i pezzi corrispondenti nel set e mettili insieme. Cerca di tenere il modello nella stessa direzione della figura e in tal modo sarà più semplice attaccare i pezzi nei posti giusti. I colori spenti ti dicono che questa sezione è già stata costruita. Dovrai collegare la nuova sezione al punto indicato dalla punta della freccia.

Spaziatori

Ci sono punti nel tuo modello a cui dovrai aggiungere spaziatori blu e argento. Accertati di contarli attentamente.

Connettori

Poi scorrere questi speciale connettori insieme. Spingi con forza finché senti un "clic". Fare molta attenzione all'istruzione e posizionare questi orizzontale o in verticale esattamente come sono mostrati.

Flexi-stangen

Een Flexi-stangen is een stang die kan gebogen worden om bochten of curves te maken. Ze maken zich gemakkelijker vast aan je model wanneer je ze eerst een paar keer heen en weer buigt.

(Pagina 34, 36)

IDEE DI COSTRUZIONE

Per istruzioni di questi modelli vai a www.knex.com/instructions inserire il codice **17435**.

(PT) Português

(Página 2)

Lista das peças

Antes de começar a montar, compare as partes do seu conjunto com as partes enumeradas aqui. Se houver algo que estiver faltando, ligue ou escreva para nós usando as informações na capa de trás. Estamos aqui para servir e ajudar.

Instruções básicas para montar o K'NEX

Comece a montar

É muito importante que posicione os conectores numa direção específica. Junta as partes simultaneamente e com firmeza até ouvires um "estalido". Presta muita atenção às instruções e coloca estes conectores horizontal ou verticalmente, exactamente conforme se mostra nas ilustrações.

Separadores

Existirão certos pontos no teu modelo que necessitam a colocação de espaçadores. Assegura-te que os contas cuidadosamente.

Conectores

Você pode fazer com que estes conectores se deslizem e se conectem. Empurre até ouvires um "clique". Preste atenção às instruções e posicione-os horizontal ou verticalmente exatamente conforme a ilustração.

Varetas flexíveis

Uma vareta flexível é uma vareta que podes dobrar para formar curvas. Para montares no teu modelo, será mais fácil se dobrares primeiro a vareta para trás e para a frente.

(Página 34, 36)

IDEIAS DE CONSTRUÇÃO

Para obter instruções destes modelos vá em www.knex.com/instructions e digite o código **17435**.

(NL) Nederlands

(Bladzijde 2)

Onderdelen Lijst

Voordat u begint met bouwen, moet u de onderdelen vergelijken de set met de onderdelen lijst hier. Als er iets ontbreekt, bel of schrijf ons gebruik van de informatie op de achterkant. We zijn hier om u te helpen!

Basisstappen voor K'NEX bouwen

Begin te bouwen

Om met je model te beginnen, vind eerst het nummer 1 en volg de nummers. Elk stuk heeft zijn eigen vorm en kleur. Kijk gewoonweg naar de afbeeldingen, vind de overeenstemmende stukken terug in je geheel en maak e aan mekaar vast. Tracht je model in dezelfde richting te plaatsen als de aanwijzingen terwijl je bouwt en monteert. De vervaagde kleuren duiden aan dat dit deel reeds is opgebouwd. Gelieve het nieuwe deel vast te koppelen op de plaats aangeduid door de pijlen.

Tussenstukken

Op bepaalde plekken van je model moet je afstandhouders gebruiken. Zorg dat je het juiste aantal afstandhouders gebruikt, zoals wordt getoond in de instructies.

Koppelstukken

Je kunt deze speciale verbindingstukken in elkaar steken. Duw ze stevig tegen elkaar aan tot je een 'klik' hoort. Let goed op de instructies en plaats ze horizontaal en verticaal, precies zoals wordt getoond.

Flexi-stangen

Een Flexi-stangen is een stang die kan gebogen worden om bochten of curves te maken. Ze maken zich gemakkelijker vast aan je model wanneer je ze eerst een paar keer heen en weer buigt.

(Bladzijde 34, 36)

BOUWIDEEËN

Voor instructies van deze modellen naar www.knex.com/instructions en vul de code **17435**.



CLASSIC CONSTRUCTIONS
Building Set
CONSTRUCTION CLASSIQUES
Jeu de construction

knex.com

@knexbrands

facebook.com/knex



SCIENCE/SCIENCE
TECHNOLOGY/TECHNOLOGIE
ENGINEERING/INGÉNIERIE
ART & DESIGN/CONCEPTION & D'ART
MATH/MATHÉMATIQUES #



Download Our App

Téléchargez notre application

Descargue nuestra aplicación

Lade unser App

Scarica il nostro App

Faça o download do nosso aplicativo

Download onze app



CREATION ZONE**
Building Set
ZONE DE CREATION
Jeu de construction



25th Anniversary
Ultimate Builder's Case**
25ème Anniversaire
Ultime Cas de Constructeur

[§] Juego inspirado
 Inspiriertes Spiel
 Ha ispirato il gioco
 Inspirou o jogo
 Geïnspireerd spel

^{*} Ciencia/Wissenschaft/
 Scienza/Ciência/Wetenschap
 Tecnología/Technologie/
 Tecnologia/Tecnologia/
 Technologie
 Ingeniería/Ingenieurwesen/
 Ingegneria/Engenharia/
 Bouwkunde
 Arte Y Diseño/Kunstdesign/
 Arte E Design/Design de arte/
 kunst En Ontwerp
 Matemáticas/Mathematik/
 Matematica/Matemática/
 Wiskunde

****Sold separately**
 Vendus séparément
 Se venden por separado
 Separat erhältlich
 Venduti separatamente
 Vendidos separadamente
 Afzonderlijk verkrijgbaar

©2017 K'NEX Limited Partnership Group, P.O. Box 700, Hatfield, PA 19440-0700; 1-800-KID-KNEX (USA/Canada/États-Unis/EE.UU.); email@knex.com; knex.com. K'NEX UK Ltd, 200 Brook Drive, Green Park, Reading, RG6 2UB England; K'NEX France, 24 rue du Quatre Septembre, 75002 Paris, France. For customers outside the USA/Canada please contact your local distributor at www.knex.com/distributors.

(FR) Pour les clients en dehors du Canada et des États-Unis, veuillez contacter votre distributeur local que vous pouvez trouver sur www.knex.com/distributors.

(ES) El cliente que no vive en EE.UU./Canadá se pone en contacto con el distribuidor local. Encuentre la información para el distribuidor local en www.knex.com/distributors.

(EN) K'NEX is a registered trademark and Imagine and Steamagination are trademarks of K'NEX Limited Partnership Group.

(FR) K'NEX est une marque déposée et Imagine et Steamagination sont une marque de K'NEX Limited Partnership Group.

(ES) K'NEX es una marca registrada y Imagine y Steamagination son marcas de K'NEX Limited Partnership Group.

(EN) Product & colors may vary. Most models can be built one at a time.

(FR) Le produit et ses couleurs peuvent varier. Les différents modèles ne peuvent être construits qu'un par un.

(ES) El producto y los colores pueden variar. La mayoría de los modelos se pueden construir uno a la vez.

(DE) Produkte und Farben können abweichen. Die meisten Modelle können immer nur einzeln gebaut werden.

(IT) Prodotti e colori possono differire. La maggior parte dei modelli si può costruire autonomamente. Istruzioni accluse.

(PT) O produto e as cores podem variar. A maioria dos modelos pode ser montado um de cada vez.

(NL) Product en kleuren kunnen variëren. De meeste modellen kunnen uitsluitend een voor een worden gebouwd.

