

# FR Mode d'emploi

## DOCK : CHARGE + VIDEO

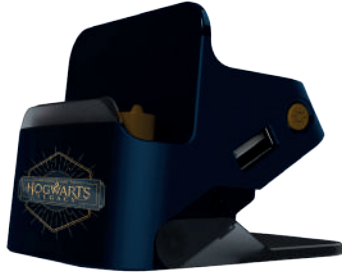

### Comment l'utiliser

#### EN INTÉRIEUR

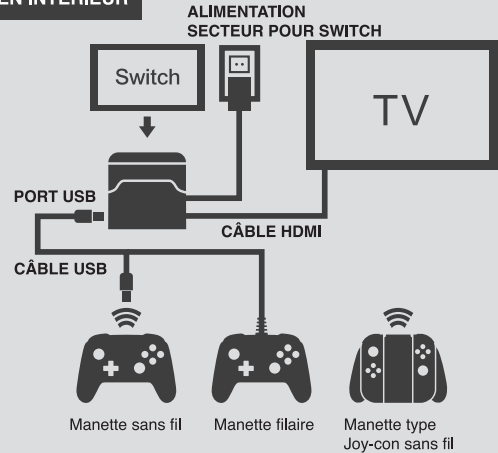

- Appuyer sur le bouton pour projeter l'écran de la console sur la TV

- L'angle de vue du dock est réglable : 3 crans pour une vue optimale

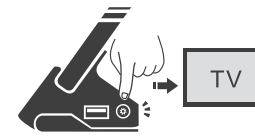

#### ATTENTION

- Pour connecter la station à votre TV, vous devez brancher la station à une prise de courant à l'aide de l'alimentation Type-C et la station à votre TV via le câble HDMI.

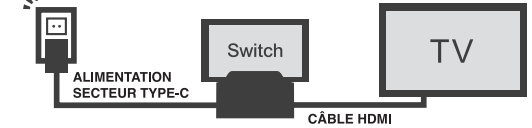

- Au moment où vous appuyez sur le bouton pour projeter l'écran de la console sur la TV, il est possible que votre manette compatible filaire se déconnecte. Vous devrez la débrancher et la rebrancher pour qu'elle se connecte.

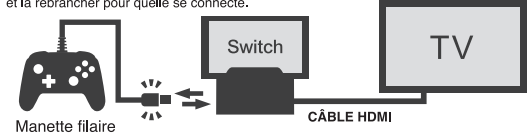

### Détails



|   |                             |   |                                      |
|---|-----------------------------|---|--------------------------------------|
| 1 | Port Type-C pour la console | 6 | Port d'alimentation Type-C           |
| 2 | Port USB                    | 7 | Port USB                             |
| 3 | Bouton affichage console/TV | 8 | Crans de réglage pour l'angle de vue |
| 4 | Port HDMI                   |   |                                      |
| 5 | Port USB 3.0                |   |                                      |

### Comment l'utiliser

#### EN EXTÉRIEUR

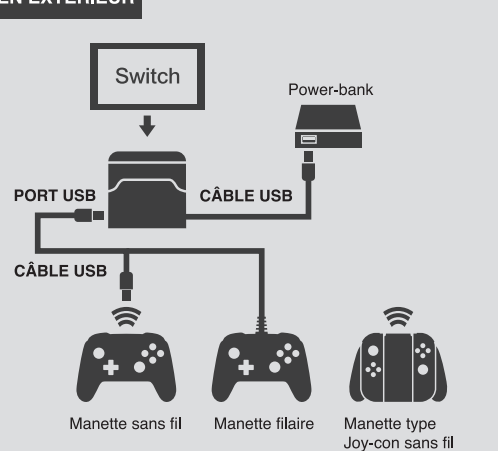

### Sécurité

- Veillez lire les informations sur la santé et la sécurité et vous y conformer. Le non-respect des précautions indiquées peut entraîner des blessures ou des dégâts matériels. L'utilisation de ce produit par des enfants doit se faire sous la supervision d'un adulte.
- N'exposez pas ce produit à des micro-ondes, à des températures élevées ou à la lumière directe du soleil.
  - Ne laissez pas ce produit entrer en contact avec des liquides et ne le manipulez pas avec des mains humides ou grasses. Si du liquide pénètre à l'intérieur de ce produit, cessez de l'utiliser.
  - Ne soumettez pas ce produit à une force excessive. Ne touchez pas ce produit lorsqu'il est en charge pendant un orage.
  - Si vous entendez un bruit suspect, que vous voyez de la fumée ou que vous sentez une odeur étrange, cessez d'utiliser ce produit.
  - N'essayez pas de démonter ou de réparer ce produit.
  - Ne touchez pas les parties endommagées. Évitez d'entrer en contact avec tout liquide s'échappant du produit.
  - Gardez les éléments d'emballage hors de portée des jeunes enfants car ils pourraient être ingérés.
  - Si le produit est sale, essuyez-le à l'aide d'un chiffon doux et sec. Évitez l'utilisation d'alcool, de diluant ou de tout autre solvant.

SUPPORT ET INFOS TECHNIQUES [WWW.FREAKSANDGEEKS.FR](http://WWW.FREAKSANDGEEKS.FR)

Freaks and Geeks® is a registered trademark of Trade Invaders®. Produced and imported by Trade Invaders, 28 av. Ricardo Mazza, 34630 Saint-Thibéry, France. [www.trade-invaders.com](http://www.trade-invaders.com). All trademarks are property of their respective owners. These owners didn't design, manufacture, sponsor or endorse this product.

# ES Instrucciones de uso

## DOCK : CHARGE + VIDEO



### Cómo utilizarlo

#### EN EL INTERIOR

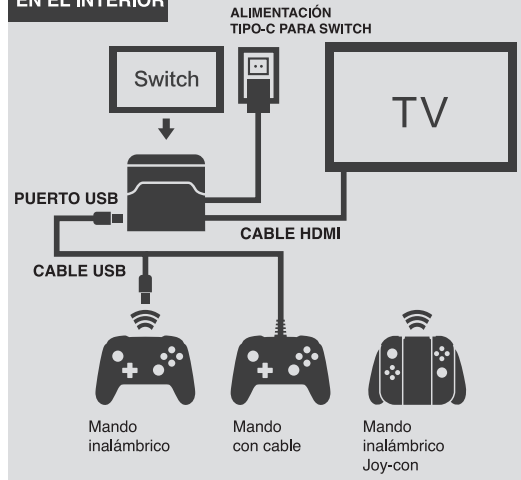

■ Pulse el botón para proyectar la pantalla de la consola en el televisor

■ El ángulo de visión de la base es ajustable: 3 niveles para una visión óptima



#### PRECAUCIÓN

■ Para conectar la base a su televisor, debe conectar la base a una toma de corriente utilizando la fuente de alimentación Tipo-C y la base a su televisor a través del cable HDMI.

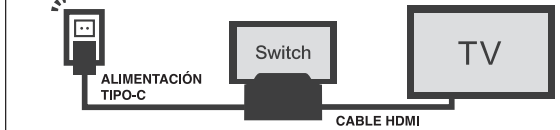

■ En el momento en que se pulsa el botón para proyectar la pantalla de la consola en el televisor, su mando con cable compatible puede desconectarse. Tendrás que desconectarlo y volver a enchufarlo para que se conecte.

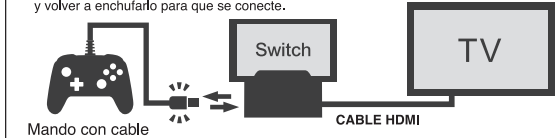

### Detalles



|   |   |
|---|---|
| 1 Puerto tipo C para la consola           | 6 Puerto alimentación tipo C              |
| 2 Puerto USB                              | 7 Puerto USB                              |
| 3 Botón de visualización de la consola/TV | 8 Muecas para ajustar el ángulo de visión |
| 4 Puerto HDMI                             |   |
| 5 Puerto USB 3.0                          |   |

### Cómo utilizarlo

#### AL AIRE LIBRE

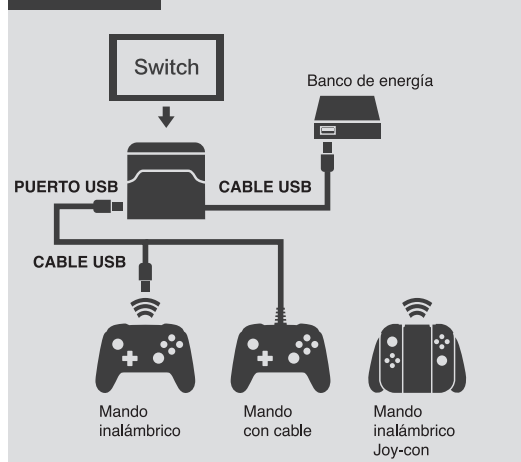

### Seguridad

Por favor, lea y respete la información sobre salud y seguridad. El incumplimiento de las precauciones indicadas puede provocar daños personales o materiales. El uso de este producto por parte de los niños debe hacerse bajo la supervisión de un adulto.

- No exponga este producto a microondas, altas temperaturas o a la luz solar directa.
- No permita que este producto entre en contacto con líquidos y no lo manipule con las manos mojadas o grasosas. Si el líquido entra en este producto, interrumpa su uso inmediatamente.
- No someta este producto a una fuerza excesiva. No toque este producto mientras se está cargando durante una tormenta.
- Si oye un ruido extraño, ve humo o huele un olor extraño, deje de usar este producto.
- No intente desmontar o reparar este producto.
- No toque las piezas dañadas. Evite el contacto con cualquier líquido que salga del producto.
- Mantenga los materiales de embalaje fuera del alcance de los niños pequeños, ya que pueden ser ingeridos.
- Si el producto está sucio, límpielo con un paño suave y seco. Evite utilizar alcohol, diluyente o cualquier otro disolvente

ASISTENCIA E INFORMACIÓN TÉCNICA: [WWW.FREAKSANDGEEKS.FR](http://WWW.FREAKSANDGEEKS.FR)

Freaks and Geeks® is a registered trademark of Trade Invaders®. Produced and imported by Trade Invaders, 28 av. Ricardo Mazza, 34630 Saint-Thibéry, France. [www.trade-invaders.com](http://www.trade-invaders.com). All trademarks are property of their respective owners. These owners didn't design, manufacture, sponsor or endorse this product.

# EN User Manual

## DOCK : CHARGE + VIDEO

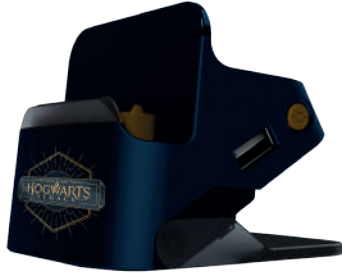

### How to use

#### INDOOR

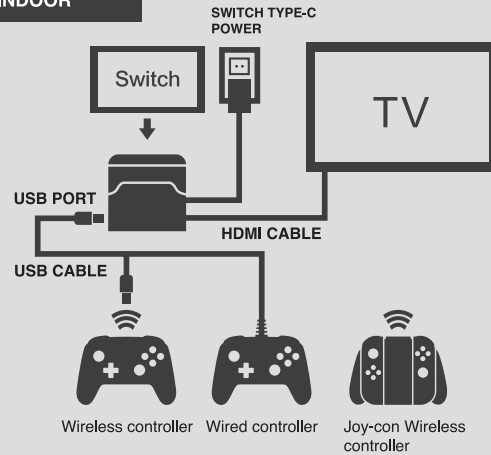

- Press button to transfer your screen to TV.
- Three-stage adjustable angle for the best view.



#### WARNING

- To connect a TV, you must connect TYPE-C power supply, and the dock to TV with the HDMI cable.

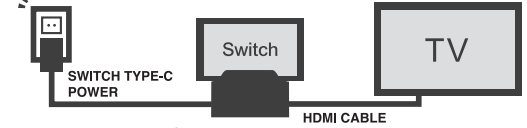

- When you press the button to transfer your screen to TV, if the (third-party) wired controller disconnect, you must re-plug it.

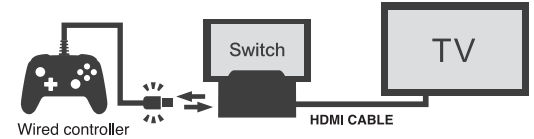

### Overview



|   |                                |   |                                |
|---|--------------------------------|---|--------------------------------|
| 1 | Type-C Port for Switch console | 6 | Type-C power supply port       |
| 2 | USB port                       | 7 | USB port                       |
| 3 | HDMI screen switching button   | 8 | Multi-angle adjustable bracket |
| 4 | HDMI port                      |   |                                |
| 5 | USB 3.0 port                   |   |                                |

### How to use

#### OUTDOOR

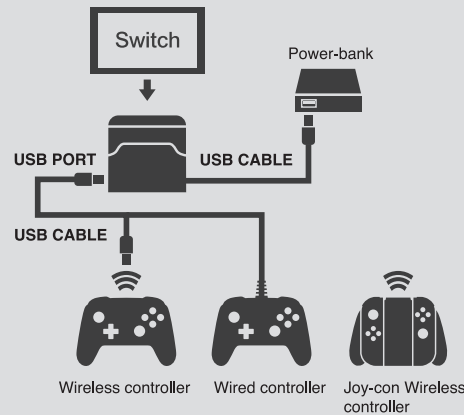

### Security

Please read and comply with the health and safety information. Failure to follow the precautions indicated may result in injury or property damage. The use of this product by children should be under adult supervision.

- Do not expose this product to microwaves, high temperatures or direct sunlight.
- Do not allow this product to come into contact with liquids and do not handle it with wet or greasy hands. If liquid enters this product, discontinue use.
- Do not subject this product to excessive force. Do not touch this product while it is charging under a thunderstorm.
- If you hear a suspicious noise, see smoke, or smell a strange odor, stop using this product.
- Do not attempt to disassemble or repair this product.
- Do not touch damaged parts. Avoid contact with any liquid leaking from the product.
- Keep packaging materials out of the reach of small children as they may be swallowed.
- If the product is dirty, wipe it with a soft, dry cloth. Avoid using alcohol, thinner or any other solvent.

INFORMATIONS & TECHNICAL SUPPORT [WWW.FREAKSANDGEEKS.FR](http://WWW.FREAKSANDGEEKS.FR)

Freaks and Geeks® is a registered trademark of Trade Invaders®. Produced and imported by Trade Invaders, 28 av. Ricardo Mazza, 34630 Saint-Thibéry, France. [www.trade-invaders.com](http://www.trade-invaders.com). All trademarks are property of their respective owners. These owners didn't design, manufacture, sponsor or endorse this product.

# IT Istruzioni per l'uso

## DOCK : CHARGE + VIDEO



### Come usarlo

#### ALL'INTERNO

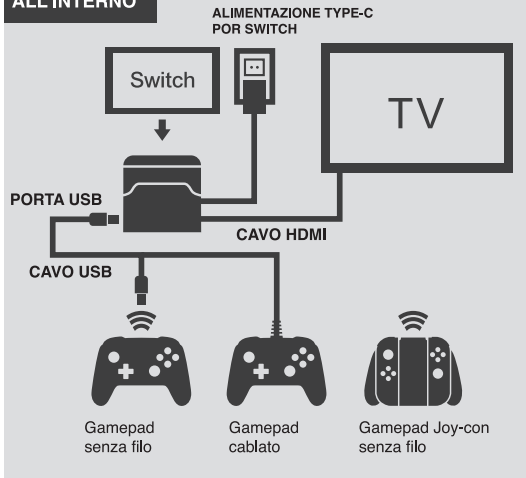

■ Premere il pulsante (⊕) per proiettare lo schermo della console sulla TV

■ L'angolo di visione del dock è regolabile: 3 tacche per una visione ottimale

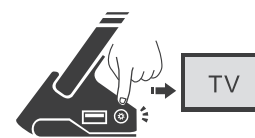

#### ATTENZIONE

■ Per collegare il dock alla TV, è necessario collegare il dock a una presa di corrente utilizzando l'alimentatore Type-C e il dock alla TV tramite il cavo HDMI

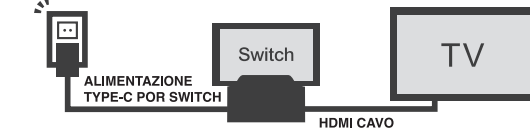

■ Nel momento in cui si preme il pulsante (⊕) per proiettare lo schermo della console sulla TV, il vostro controller cablato compatibile potrebbe discollegarsi. È necessario staccare la spina e ricollegarlo per farlo connettere.

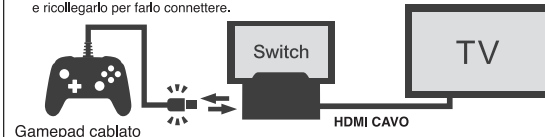

### Dettagli



|   |                                       |   |  |
|---|---------------------------------------|---|--|
| 1 | Porta Type-C per la console           | 6 | Porta di alimentazione Type-C                    |
| 2 | Porta USB                             | 7 | Porta USB  |
| 3 | Pulsante del display della console/TV | 8 | Tacche per la regolazione dell'angolo di visione |
| 4 | Porta HDMI                            |   |  |
| 5 | Porta USB 3.0                         |   |  |

### Come usarlo

#### ALL'APERTO

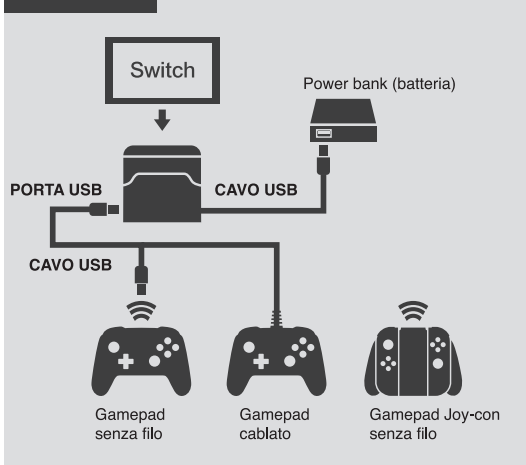

### Security

Si prega di leggere e rispettare le informazioni sulla salute e la sicurezza. Il mancato rispetto delle precauzioni elencate può provocare lesioni personali o danni materiali. L'uso di questo prodotto da parte dei bambini deve avvenire sotto la supervisione di un adulto.

- Non esporre questo prodotto a microonde, alte temperature o alla luce del direttamente.
- Non permettere che questo prodotto entri in contatto con liquidi e non usarlo con mani bagnate o unte. Se il liquido entra in questo prodotto, interrompere l'uso.
- Non sottoporre questo prodotto a una forza eccessiva. Non toccare questo prodotto mentre è in carica durante un temporale.
- Se senti un rumore strano, del fumo o senti un odore strano, smetti di usare questo prodotto.
- Non tentare di smontare o riparare questo prodotto.
- Non toccare le parti danneggiate. Evitare il contatto con qualsiasi liquido che fuoriesce dal prodotto.
- Tenere i materiali d'imballaggio fuori dalla portata dei bambini piccoli, in quanto possono essere ingeriti.
- Se il prodotto è sporco, pulirlo con un panno morbido e asciutto. Evitare l'uso di alcool, diluente o qualsiasi altro solvente.

SUPPORTO E INFORMAZIONI TECNICHE [WWW.FREAKSANDGEEKS.FR](http://WWW.FREAKSANDGEEKS.FR)

Freaks and Geeks® is a registered trademark of Trade Invaders®. Produced and imported by Trade Invaders, 28 av. Ricardo Mazza, 34630 Saint-Thibéry, France. [www.trade-invaders.com](http://www.trade-invaders.com). All trademarks are property of their respective owners. These owners didn't design, manufacture, sponsor or endorse this product.

# PT Instruções de utilização

## DOCK : CHARGE + VIDEO



### Como utilizar

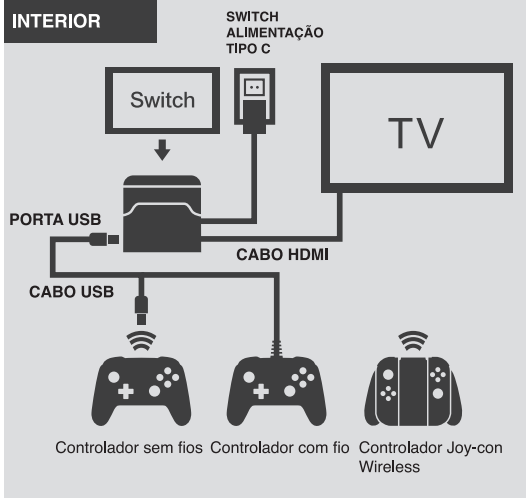

- Prima o botão para transferir o seu ecrã para a TV.
- Ângulo ajustável em três fases para a melhor visualização.



- Para ligar uma televisão, é necessário ligar a fonte de alimentação TYPE-C, e a doca à TV com o cabo HDMI.

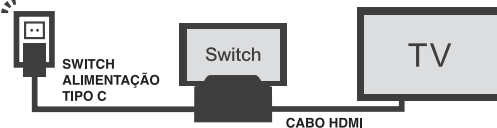

- Ao premir o botão para transferir o seu ecrã para a TV, se o controlador USB (de terceiros) com fio se desligar, deve voltar a ligá-lo à tomada.

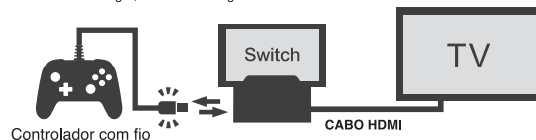

### Visão geral



|   |                                  |   |   |
|---|----------------------------------|---|---|
| 1 | Porta Tipo C para consola Switch | 6 | Porta de fornecimento de energia tipo C |
| 2 | porta USB                        | 7 | porta USB                               |
| 3 | Botão de comutação do ecrã HDMI  | 8 | Suporte multi-ângulo ajustável          |
| 4 | porta HDMI                       |   |   |
| 5 | porta USB 3.0                    |   |   |

### Como utilizar

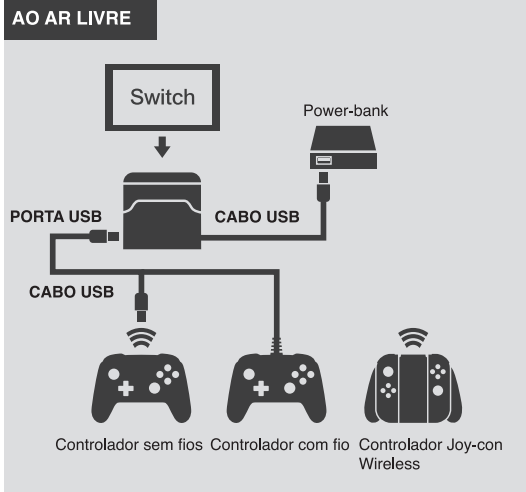

### Segurança

Por favor, leia e cumpra as informações sobre saúde e segurança. O não cumprimento das precauções indicadas pode resultar em lesões ou danos materiais. A utilização deste produto por crianças deve estar sob supervisão de um adulto.

- Não expor este produto a micro-ondas, altas temperaturas ou luz solar directa.
- Não permitir que este produto entre em contacto com líquidos e não o manusear com as mãos molhadas ou gordurosas. Se entrar líquido neste produto, descontinuar a sua utilização.
- Não sujeitar este produto a força excessiva. Não tocar neste produto enquanto ele estiver a carregar durante uma trovoadas.
- Se ouvir um ruído suspeito, ver fumo, ou cheirar um odor estranho, parar de usar este produto.
- Não tentar desmontar ou reparar este produto.
- Não tocar em peças danificadas. Evitar o contacto com qualquer fuga de líquido do produto.
- Manter os materiais de embalagem fora do alcance das crianças pequenas, pois podem ser engolidos.
- Se o produto estiver sujo, limpe-o com um pano macio e seco. Evitar usar álcool, diluente ou qualquer outro solvente.

INFORMAÇÕES & APOIO TÉCNICO [WWW.FREAKSANDGEEKS.FR](http://WWW.FREAKSANDGEEKS.FR)

Freaks and Geeks® is a registered trademark of Trade Invaders®. Produced and imported by Trade Invaders, 28 av. Ricardo Mazza, 34630 Saint-Thibéry, France. [www.trade-invaders.com](http://www.trade-invaders.com). All trademarks are property of their respective owners. These owners didn't design, manufacture, sponsor or endorse this product.

# NL Instructies voor gebruik

## DOCK : CHARGE + VIDEO



### Hoe te gebruiken

#### BINNEN

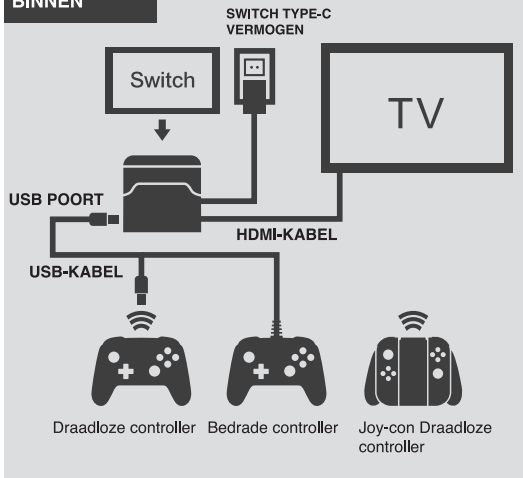

■ Druk op de knop (⊕) om uw scherm naar de TV over te brengen.

■ In drie standen instelbare hoek voor het beste zicht.



■ Om een TV aan te sluiten, moet u de TYPE-C voeding aansluiten en het dock met de HDMI-kabel op de TV aansluiten.

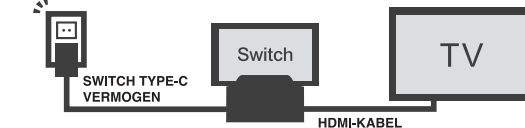

■ Wanneer u op de knop (⊕) drukt om uw scherm naar de TV over te brengen, moet u de bedrade USB-controller (van derden) opnieuw aansluiten als de verbinding wordt verbroken.

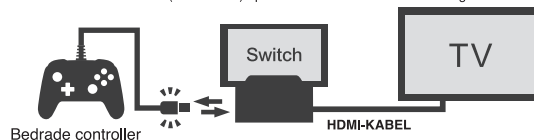

### Overzicht



|   |                                  |   |                                |
|---|----------------------------------|---|--------------------------------|
| 1 | Type-C-poort voor schakelconsole | 6 | Type-C stroomvoorzieningspoort |
| 2 | USB-poort                        | 7 | USB-poort                      |
| 3 | HDMI-schermomschakelingstoets    | 8 | Multi-hoek verstelbare beugel  |
| 4 | HDMI-poort                       |   |                                |
| 5 | USB 3.0 poort                    |   |                                |

### Hoe te gebruiken

#### BUITEN

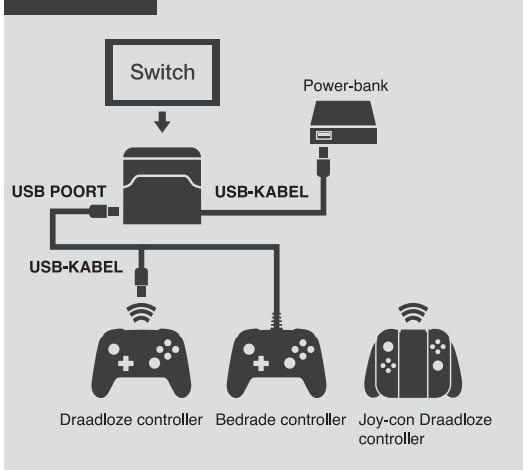

### Beveiliging

Lees de gezondheids- en veiligheidsinformatie en neem deze in acht. Het niet opvolgen van de aangegeven voorzorgsmaatregelen kan leiden tot letsel of schade aan eigendommen. Het gebruik van dit product door kinderen dient onder toezicht van een volwassene te geschieden.

- Stel dit product niet bloot aan microgolven, hoge temperaturen of direct zonlicht.
- Laat dit product niet in contact komen met vloeistoffen en hanteer het niet met natte of vette handen. Als er vloeistof in dit product terecht komt, stop dan met het gebruik.
- Oefen geen overmatige druk uit op dit product. Raak dit product niet aan terwijl het wordt opgeladen tijdens onweer.
- Indien u een verdacht geluid hoort, rook ziet of een vreemde geur ruikt, stop dan met het gebruik van dit product.
- Probeer dit product niet uit elkaar te halen of te repareren.
- Raak geen beschadigde onderdelen aan. Vermijd contact met een vloeistof die uit het product lekt.
- Houd verpakkingsmateriaal buiten het bereik van kleine kinderen, omdat het kan worden ingeslikt.
- Als het product vuil is, veeg het dan af met een zachte, droge doek. Vermijd het gebruik van alcohol, thinner of andere oplosmiddelen.

INFORMATIE & TECHNISCHE ONDERSTEUNING [WWW.FREAKSANDGEEKS.FR](http://WWW.FREAKSANDGEEKS.FR)

Freaks and Geeks® is a registered trademark of Trade Invaders®. Produced and imported by Trade Invaders, 28 av. Ricardo Mazza, 34630 Saint-Thibéry, France. [www.trade-invaders.com](http://www.trade-invaders.com). All trademarks are property of their respective owners. These owners didn't design, manufacture, sponsor or endorse this product.

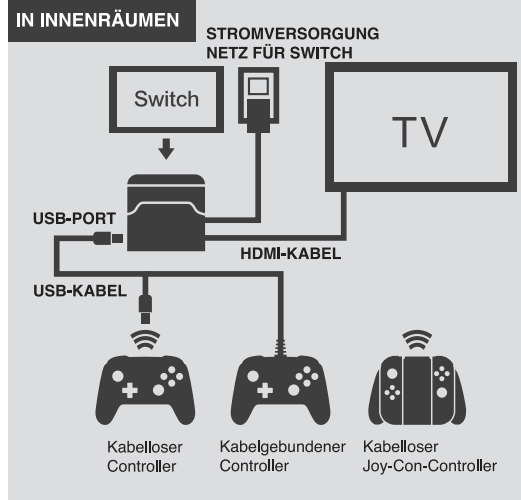
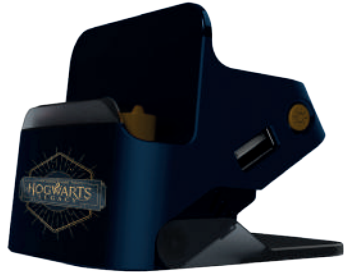

- Drücken Sie die Taste um zu projizieren den Bildschirm der Konsole auf den Fernseher
- Der Blickwinkel des Docks ist einstellbar: 3 Rastungen für eine optimale Sicht



- Um die Station mit Ihrem Fernseher zu verbinden, müssen Sie die Station mithilfe des Typ-C-Netzteils an eine Steckdose und die Station über das HDMI-Kabel an Ihren Fernseher anschließen.

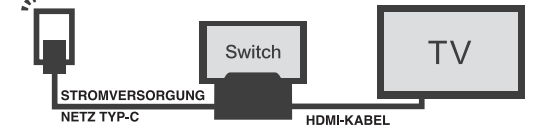

- In dem Moment, in dem Sie die Taste drücken, um den Bildschirm der Konsole auf den Ferns

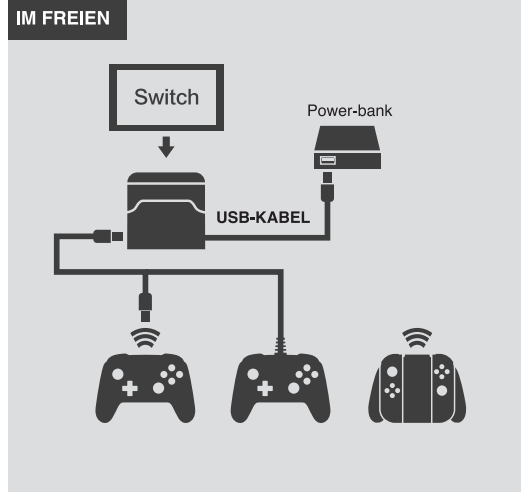
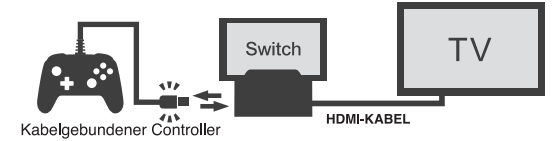

# SV Bruksanvisningar

## DOCK : CHARGE + VIDEO



### Hur man använder den

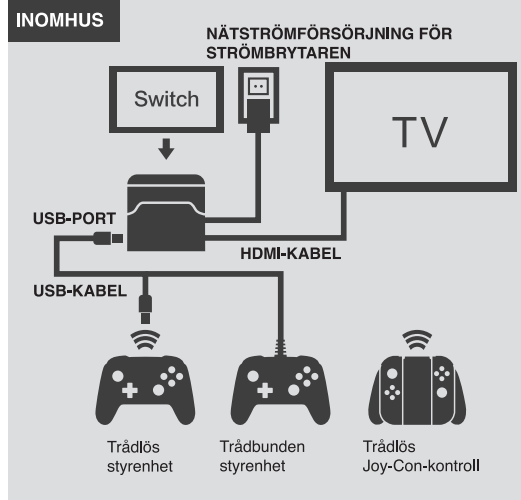

- Tryck på knappen för att projicera konsolens skärm på TV:n.
- Dockans betraktningvinkel är justerbar: 3 läsnings för en optimal vy.



### UPPMÄRKNING

- Om du vill ansluta dockningsstationen till TV:n måste du ansluta dockningsstationen till ett eluttag med hjälp av Type-C-adaptorn och ansluta dockningsstationen till TV:n med hjälp av HDMI-kabeln.

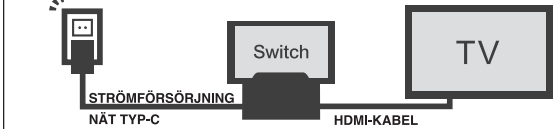

- När du trycker på knappen för att projicera konsolskärmen på TV:n kan det hända att din kompatibla handkontroll med kabel kopplas bort. Du måste koppla ur kontrollenheten och sedan koppla in den igen för att anslutningen ska återupprättas.

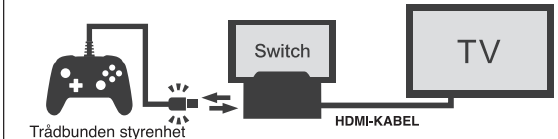

### Detaljer



|                               |  |
|-------------------------------|--|
| 1 Typ-C-port för konsolen     | 6 Typ-C-strömport                            |
| 2 USB-Port                    | 7 USB-Port                                   |
| 3 Knapp för konsol/TV-display | 8 Knapparna för justering av visningsvinkeln |
| 4 HDMI-Port                   |  |
| 5 USB 3.0-Port                |  |

### Hur man använder den

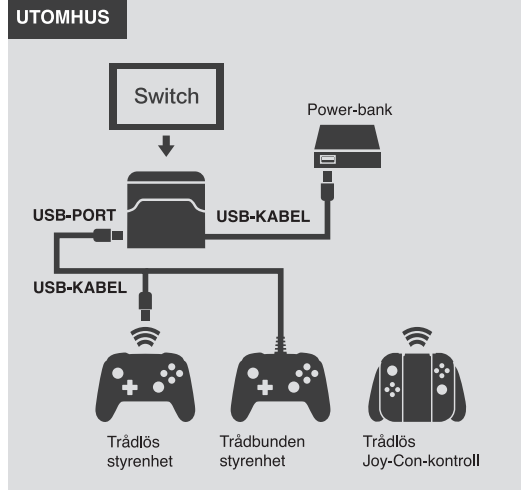

### Säkerhet

Läs och följ informationen om hälsa och säkerhet. Om du inte följer de angivna försiktighetsåtgärderna kan det leda till skada eller skada på egendom. Barn bör använda denna produkt endast under vuxnas överinseende.

- Utsätt inte produkten för mikrovågor, höga temperaturer eller direkt solljus.
- Låt inte produkten komma i kontakt med vätskor och använd den inte med våta eller feta händer. Om vätska kommer in i produkten ska du sluta använda den.
- Utsätt inte den här produkten för överdriven kraft. Rör inte produkten när den laddas under ett åskväder.
- Om du hör ett misstänkt ljud, ser rök eller känner en konstig lukt, sluta använda produkten.
- Försök inte demontera eller reparera produkten.
- Rör inte skadade delar. Undvik att komma i kontakt med vätskor som läcker från produkten.
- Håll förpackningsdelarna borta från små barn eftersom de kan sväljas.
- Om produkten blir smutsig, torka av den med en mjuk, torr trasa. Undvik att använda alkohol, thinner eller andra lösningsmedel.

SUPPORT UND TECHNISCHE INFOS [WWW.FREAKSANDGEEKS.EU](http://WWW.FREAKSANDGEEKS.EU)

Freaks and Geeks® är ett registrerat varumärke som tillhör Trade Invaders®, Producerad och importerad av Trade Invaders, 28 av, Ricardo Mazza, 34630 Saint-Thibéry, Frankrike, [www.trade-invaders.com](http://www.trade-invaders.com), Alla varumärken tillhör sina respektive ägare. Dessa ägare har inte konstruerat, tillverkat, sponsrat eller godkänt denna produkt.