



User Guide

Truly Wireless Earphones

TW-E3B

EN

Contents

Introduction	4
Cautions regarding product handling	5
Advantages of this product	6
Accessory and part names	7
Charging and Powering	9
Charging the earphones	9
Charging the charging Case	10
Turning on the power	12
Turning off the power	13
Remaining Battery Power	14
Bluetooth® Connectivity	15
Pairing for the First Time	15
Pairing with a Different Device	18
Connecting to a Device Already Paired	21
Wearing This Product	22
Putting on the earphones	22
Replacing the eartips	23
Operation (Music Playback and Phone Calls)	24
Playing back music on this product	24
Talking on the phone	25
Starting the voice assistant	26
Dedicated Application	27
Using the “Headphones Controller” app	27
App settings	28

Troubleshooting 30

Read this first	30
Cannot connect	31
Power will not turn on	32
The product cannot be charged	33
The product does not operate or play back	34
No sound can be heard	35
Sound can only be heard from one earphone	36
Sound is not good or sounds strange	37
The sound is distorted, noisy or choppy.	38
Using only one of the earphones	39
Resetting and initializing the product	40
Updating the firmware	43
List of support centers	44

Appendix 45

List of operations	45
List of indicator displays and audio messages	47
Specifications	49
Trademarks	50

Introduction

About this Documentation

This documentation is intended for users of this product, and explains how to connect and operate the product.

- This documentation classifies precautions and other matters as follows.



WARNING

This content indicates *“risk of serious injury or death.”*



CAUTION

This content indicates *“risk of injury.”*

- **NOTICE**

Indicates points that you must observe in order to prevent product failure, damage or malfunction and data loss, as well as to protect the environment.

- **NOTE**

Indicates notes on instructions, restrictions on functions, and additional information that may be helpful.

- All illustrations and screens shown in this documentation are for explanatory purposes.
- All company names, product names and other such listings in this documentation are the registered trademarks or trademarks of their respective companies.
- Text labeled as [search tag] is for the purpose of searching. These tags are used as links from the “Quick Start Guide” to the “User Guide.”

Cautions regarding product handling

Please read the “Safety Brochure” included with this product and use caution regarding the following points.

Waterproof performance

The waterproof performance of this product are as shown below. Product failures caused by water ingress due to incorrect handling are not covered by the warranty.

- **Earphones**

The waterproof performance of the body of these earphones is compliant with IPX5 standards. The earphones are protected by direct jets of water from all directions. (The waterproof performance of this product will not continue to last, and may degrade through regular use.)

- **Charging case**

The charging case and the included USB power cable are not waterproof. Use caution regarding the following to avoid electric shock or product failure.

- Do not expose this product to liquids such as sweat, rainwater or seawater.
- Thoroughly wipe off any sweat, rainwater, seawater or other liquids that get on the earphones before placing them back in the charging case.

About IPX

- IPX refers to a product’s “liquid ingress protection” as cited in JIS C 0920 (the harmonized standard of IEC 60529), “Degrees of protection provided by enclosures (IP Code)”.
- These are provisions that guarantee the performance of a product in fresh water or tap water at room temperature. This does not guarantee equivalent performance in warm water, seawater or the like.

About the charging performance

This product contains lithium-ion batteries in both the earphones and in the charging case. Lithium-ion batteries are consumable items. To extend the life of the batteries as long as possible, use caution regarding the following.

- If the product is not used for a long period of time, it may take longer to recharge the batteries.
- When storing the product for a long time, charge the product around once every six months to avoid excessive discharge.
- If the duration of the battery’s charge is too short, it may have reached the end of its lifespan. Contact Yamaha dealer or service center.

Advantages of this product

This product is a set of wireless earphones that connect to Bluetooth devices such as a portable music player or smartphone.

High-definition playback of sound from Bluetooth devices

This product supports the Qualcomm aptX™ and AAC codecs.

Supports Qualcomm TrueWireless™ Stereo Plus (TWS+)

This product supports TrueWireless Stereo Plus-compatible Bluetooth devices, offering more stable connectivity.

LISTENING CARE feature

This product features LISTENING CARE, which lets you enjoy rich sound quality even at a low volume. Focusing on the characteristics of the human ear where the low- and high-end sounds become harder to hear at lower volumes, as well as how things sound differently in different listening environments, this feature corrects the sound balance for the optimal sound to match the volume. By rendering a natural sound that's easy to listen to, this feature reduces the load on your ears caused by excessive levels.

Smartphone feature support

You can use this product to talk on the phone and start up the voice assistant while connected to this product.

Dedicated smartphone app: Headphones Controller

Use the Headphones Controller app to configure more detailed settings.

Related links

- “Starting the voice assistant” (p.26)
- “Using the “Headphones Controller” app” (p.27)
- “App settings” (p.28)

Accessory and part names

Make sure that all of the accessories are included with this product.

Earphones

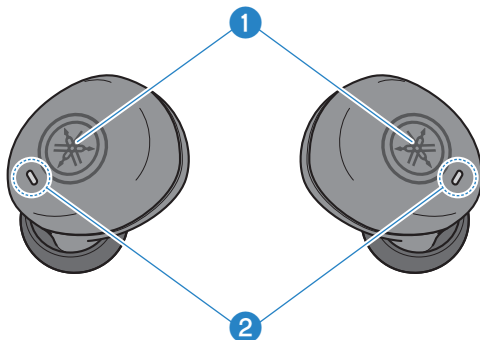

1 **Function key**

2 **Indicator**

Charging case

Front

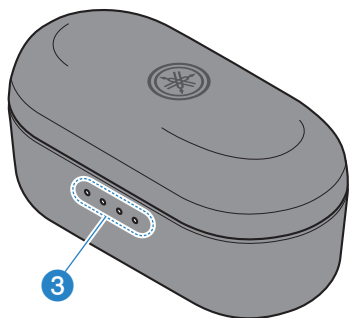

3 **Charging indicators**

Back

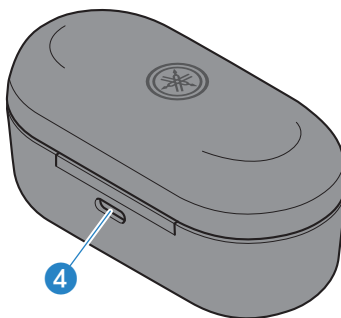

4 **Charging connector**

USB power cable (30 cm (11-3/4 in); type A to C)

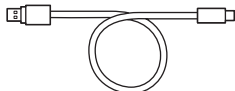

Eartips (XS, S, M, L; one set each)

Note: The M-size eartips are pre-attached.

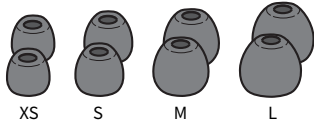

Quick Start Guide

Safety Brochure

NOTE

- The earphones feature a built-in microphone.
- The charging case contains a battery for charging the earphones.

Charging and Powering

Charging the earphones

Charge the earphones before use by placing them in the charging case.



CAUTION

- The charging case is not waterproof. Thoroughly wipe off any sweat, rainwater, seawater or other liquids that get on the earphones before placing them back in the charging case.
- Charge this product within a temperature range of 5 to 40°C.

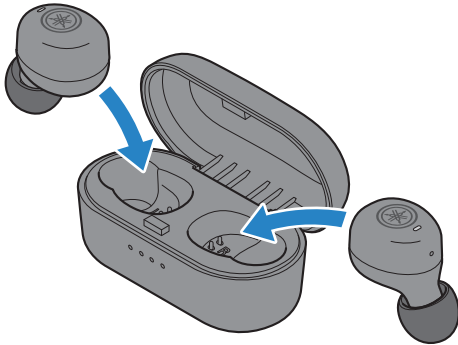

1 Open the charging case lid.

2 Place the earphones in the charging case.

The earphone indicators light up red while charging, and turn off when charging is completed.

Charging takes about 2 hours.

NOTE

- When the remaining battery power of the charging case is completely depleted while charging the earphones, the earphones will turn on.
- Once you place the earphones in the charging case, the indicators on the charging case will show the remaining battery power for five seconds (except when the charging case itself is still charging).
- The earphones will not connect to Bluetooth or be used for playback while charging.

Related links

“Appendix” (p.45)

Charging the charging Case

To charge the charging case, connect the included USB power adapter.



CAUTION

- The charging case is not waterproof. Do not expose this product to liquids such as sweat, rainwater or seawater.
- Be sure to use the USB power cable that was included with this product.
- When using a USB power adapter, be sure that the commercially-available adapter is compatible with 5 V DC (at least 0.5 A) power output.
- When charging this product inside of China, be sure to use a USB power adaptor that is approved by CCC.
- Charge this product within a temperature range of 5 to 40°C.

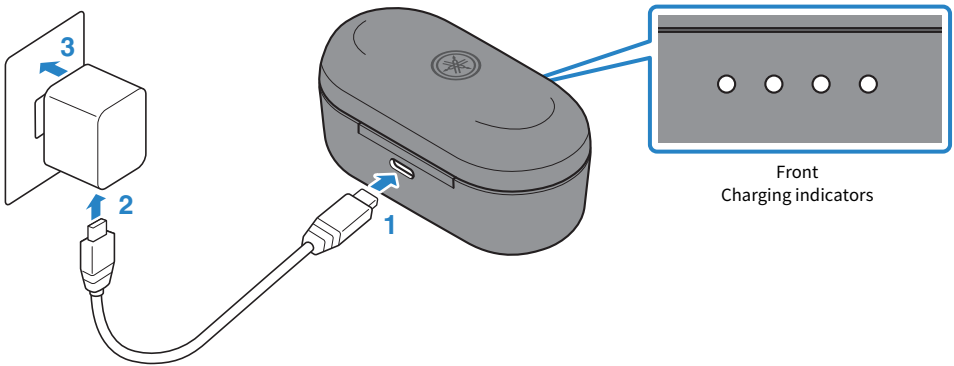

Front
Charging indicators

- 1 Plug the USB power cable (type C side) into the charging case.**
- 2 Plug the USB power cable (type A side) into the USB power adaptor.**
- 3 Plug the USB power adaptor into the power outlet.**

Charging will begin. Charging takes about 2 hours.

While the case is charging, the indicators light up as shown below.

Remaining battery power	Indicator
100%	
75–100%	
50–75%	
25–50%	
0–25%	

: Lights up

: Flashes

: Not lit

NOTE

- You can also charge the earphones while the charging case is charging.
- You may charge from the USB port on your computer instead of using a USB power adaptor.
- Once you place the earphones in the charging case, the indicators on the charging case will show the remaining battery power for five seconds (except when the charging case itself is still charging).

Turning on the power

Turn on the earphones.

1 Remove the earphones from the charging case.

The indicators light up as shown below, and the power turns on.

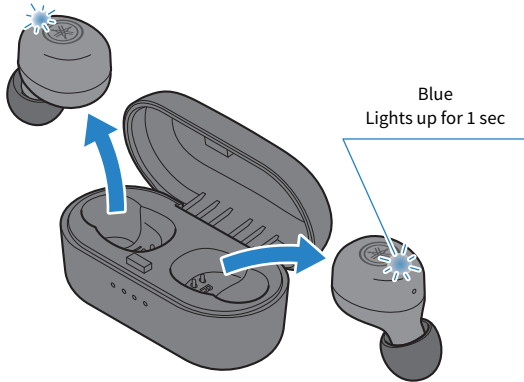

NOTE

- If the earphones have been removed from the charging case or if they do not turn on when removed from the charging case, hold down the function key on each earphone (L, R) until their indicators light up blue.
- When an earphone is low on battery power, its indicator will flash red three times when the power is turned on. If this happens, charge the earphone.

Related links

[“Remaining Battery Power” \(p.14\)](#)

Turning off the power

Turn off the earphones.

1 Place the earphones in the charging case.

The earphone power will turn off, and the product will enter charging mode.

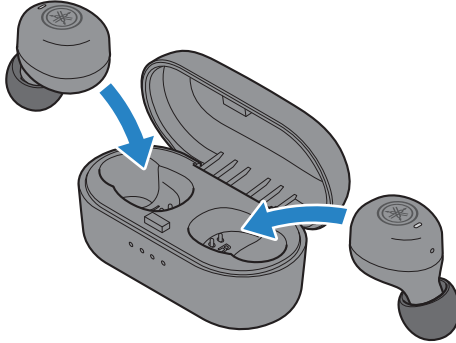

NOTE

- When you want to turn off the earphones without putting them back in the charging case, hold down the function key on each earphone (L, R) until the indicators light red. You will hear the "Power Off" audio message in the earphones.

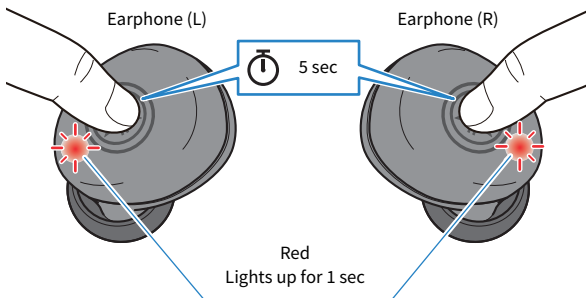

- When the remaining battery power of the charging case is depleted, the earphones will not turn off even when they are placed in the charging case. If this happens, use the function keys on each earphone to turn them off.

Remaining Battery Power

After this product is turned on, you can check how much battery power is left from the audio messages in the earphones and by the indicators.

- **Audio messages:**

- Battery High: plenty of charge remaining
- Battery Medium: moderate charge remaining
- Battery Low: small amount of charge remaining

- **Indicators (on earphones):**

- Flashes three times (red): small amount of charge remaining

NOTE

You can check the remaining battery power of the charging case at the following times.

- While charging the charging case
- Right after placing the earphones into the charging case (except when the charging case itself is charging)

Related links

“Charging the charging Case” (p.10)

Bluetooth® Connectivity

Pairing for the First Time

When first connecting this product to a Bluetooth device (such as a smartphone), follow the steps below to pair (register) this product with that device.

[Search tag] #Q02 Pairing

1 Remove the earphone (R) from the charging case.

The indicator lights up as shown below, and the unit enters pairing standby mode.

Do not take out earphone (L) yet.

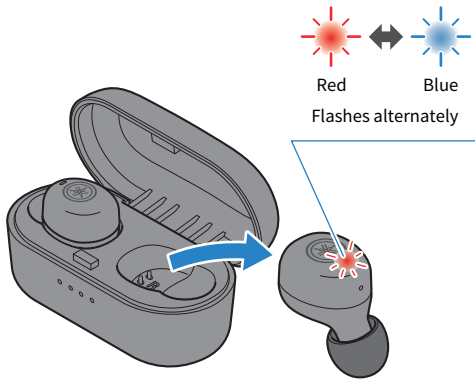

2 Activate Bluetooth on your Bluetooth device.

A list of Bluetooth devices that can be connected will be shown.

3 Select this product from the list on your Bluetooth device.

If a passkey is required when connecting, input “0000”.

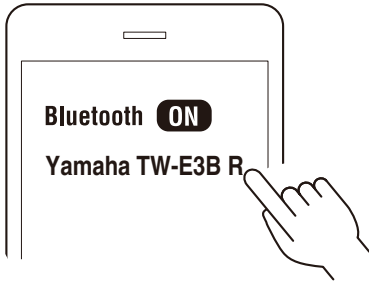

Once connected, the indicator on earphone (R) lights up as shown below. You will hear the “Pairing Successful” audio message in the earphone.

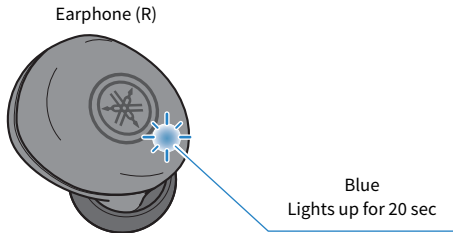

4 Next, remove earphone (L).

When the indicator lights up purple for one second, it is ready for use.

When you see a message on your Bluetooth device to register (pair) earphone (L), follow the instructions to pair. The other earphone may be listed as “Headset,” depending on the Bluetooth device.

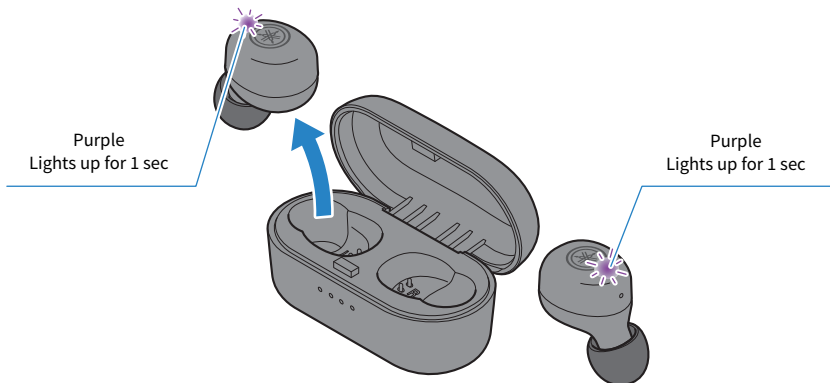

NOTE

- Pairing standby mode will automatically end on this product after about two minutes. To pair again or if the connection was unsuccessful, place the earphones back into the charging case and start again at step 1.
- The other earphone may be listed as “Disconnected” on the setting screen of your Bluetooth device. However, this is not a problem if you can hear the audio in both earphones.
- For Bluetooth devices that support Qualcomm TrueWireless™ Stereo Plus (TWS+), the status of both earphones will be “Connected.”

Related links

- “Pairing with a Different Device” (p.18)
- “Connecting to a Device Already Paired” (p.21)
- “Using the “Headphones Controller” app” (p.27)

Pairing with a Different Device

Follow the steps below to pair with another Bluetooth device, or to try pairing with the same device again. It's important to turn off both earphones (L, R) before doing this.

[Search tag] #Q02 Pairing

1 With the power on the earphones (L, R) turned on, keep pressing their function keys until their indicators light up red.

The power will turn off.

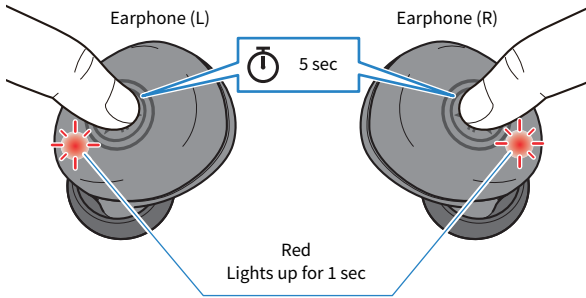

2 Keep pressing the function key on earphone (R) until its indicator lights up as shown below.

You will hear the “Pairing” audio message in earphone (R), and the earphone will enter pairing standby mode.

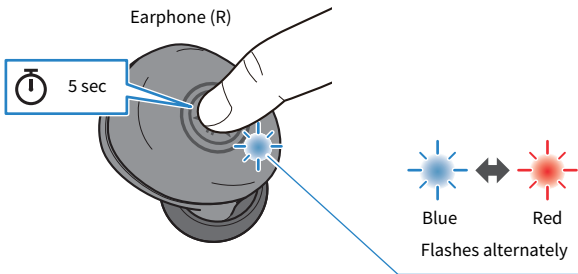

3 Activate Bluetooth on the Bluetooth device.

A list of Bluetooth devices that can be connected will be shown.

4 Select this product from the list on your Bluetooth device.

If a passkey is required when connecting, input “0000”.

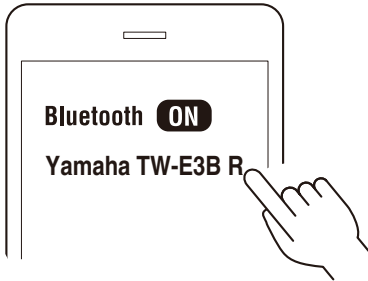

If successfully connected, you will hear the “Pairing Successful” audio message in the earphone. The earphone indicator lights up as shown below.

Earphone (R)

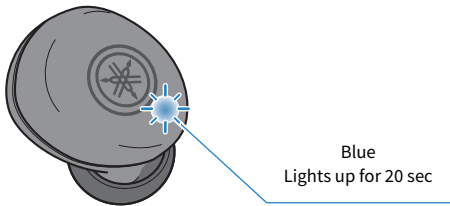

5 Hold down the function key on the earphone (L) for about two seconds, until its indicator lights blue.

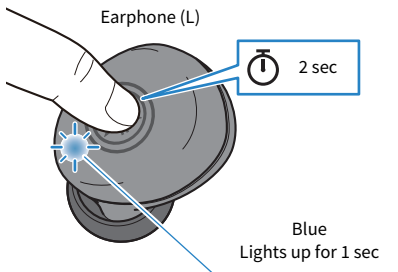

After this, the indicator lights up purple for one second, and the earphone is ready for use.

When you see a message on your Bluetooth device to register (pair) earphone (L), follow the instructions to pair. The other earphone may be listed as “Headset,” depending on the Bluetooth device.

NOTE

- Pairing standby mode will automatically end on this product after about two minutes. To pair again, start from step 1.
- Up to three Bluetooth devices can be registered with this product. If you pair a device beyond the maximum number, the information for device you first paired (the oldest pairing) will be deleted.
- This product does not support multi-point connectivity (connection to multiple devices at the same time).

Related links

- “Pairing for the First Time” (p.15)
- “Connecting to a Device Already Paired” (p.21)
- “Using the “Headphones Controller” app” (p.27)

Connecting to a Device Already Paired

Here's how to connect to a Bluetooth device to which this product has already been paired.

When you remove the earphones from the charging case, they will turn on and connect automatically with the last Bluetooth device to which they were connected. If successfully connected, you will hear the "Connected" audio message in the earphones. The indicator will display as shown below.

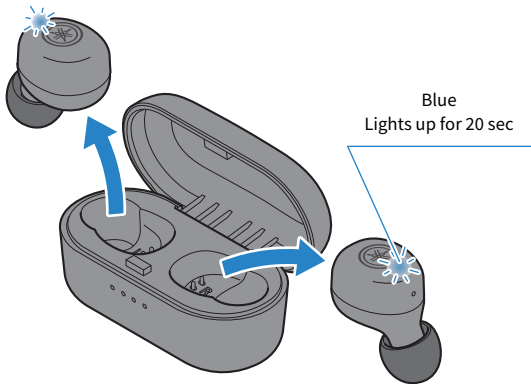

If the earphones do not automatically connect to a Bluetooth device, they are waiting for a connection or are in pairing standby mode. Make the connection to the earphones from your Bluetooth device.

NOTE

- One of the earphones (L or R) will be the primary earphone when connecting, according to their remaining battery power. The earphones will appear in the list shown on the Bluetooth device as shown below.
 - Earphone (L): Yamaha TW-E3B L
 - Earphone (R): Yamaha TW-E3B R
- The other earphone may be listed as "Headset," depending on the Bluetooth device.
- This product does not support multi-point connectivity (connection to multiple devices at the same time).

Related links

- "Pairing for the First Time" (p.15)
- "Pairing with a Different Device" (p.18)

Wearing This Product

Putting on the earphones

Check the markings on the earphones for the “L” (Left) and “R” (Right) sides to make sure they are worn in the correct ear, and insert them into your ear. Move the earphones to adjust them so that they fit well in your ears after you put them on.

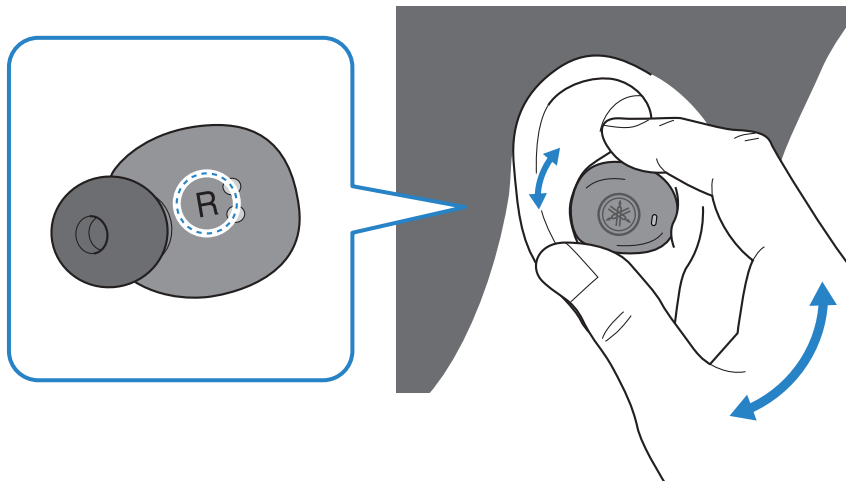

Related links

[“Replacing the eartips” \(p.23\)](#)

Replacing the eartips

When using different eartips, select the size that matches your ears. When putting the earphones on, use the eartips that keep out ambient sounds as much as possible while the music is stopped.

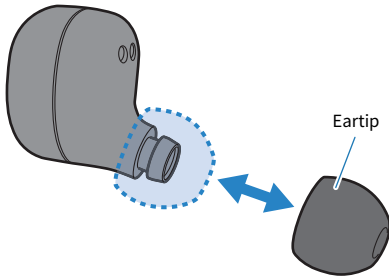

NOTE

4 sizes of eartips are included with this product. The earphones come pre-attached with M-size eartips.



CAUTION

- Do not use broken eartips or wear the earphones without eartips. Doing so may damage your ears.
- Firmly attach the eartips. Failure to do so may cause them to come loose inside your ears, which may damage your ears. If an eartip comes loose inside your ear, consult a physician.
- Once removed, keep the eartips out of reach of children, to avoid them being accidentally swallowed.

Operation (Music Playback and Phone Calls)

Playing back music on this product

You can operate this product using the function keys during playback as follows.

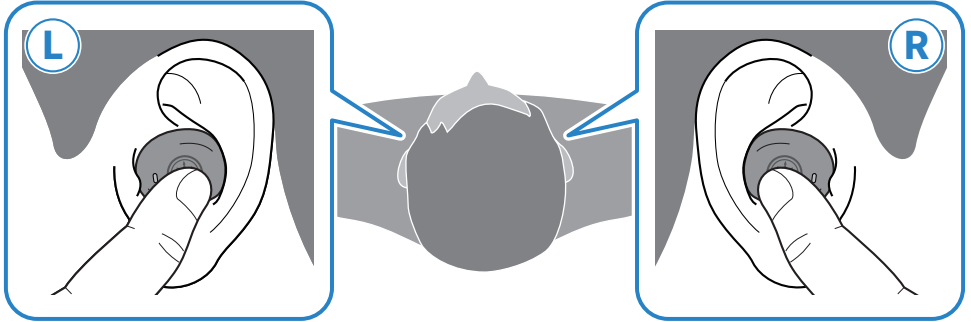

Volume controls

- Turn the volume up
Press the function key on earphone (R) two times in a row.
- Turn the volume down
Press the function key on earphone (L) two times in a row.

Playing back music

- Pause/play
Press the function key on earphone (L) or (R).
- Skip to the next song
Hold down the function key on earphone (R) until you hear a “beep” sound (about two seconds).
Take your finger off the key once you hear the beeping sound.
- Go back to the beginning of the song (while in the middle of the song), or back to the previous song (when at the beginning of a song)
Hold down the function key on earphone (L) until you hear a “beep” sound (about two seconds).
Take your finger off the key once you hear the beeping sound.
The operation may differ, depending on the Bluetooth device or app you use.

NOTE

When connecting to a device (such as a smartphone) on which the volume can be adjusted, you can also adjust the volume using that device.

- To select a song for playback, operate the connected device.

Talking on the phone

You can use this product to talk on the phone when connecting to a Bluetooth device such as a smartphone. Operate this product as follows.

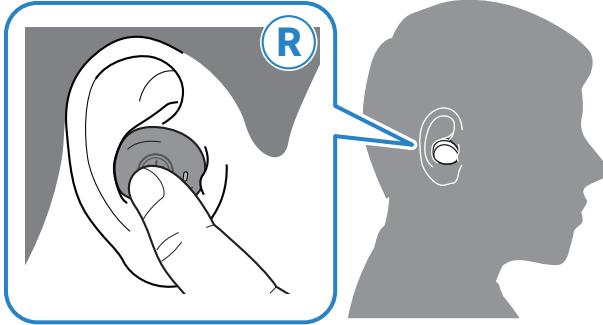

- Receive a phone call
Press the function key on earphone (R) when a call comes in.
- End a phone call
Press the function key on earphone (R) during the call.
- Ignore a call
Hold down the function key on earphone (R) for at least two seconds when the call is coming in.
Take your finger off the key once you hear the beeping sound.
- Turn the volume up
Press the function key on earphone (R) two times in a row during the call.
- Turn the volume down
Press the function key on earphone (L) two times in a row during the call.

NOTE

When a call is coming in, any music being played will be paused. Music playback will automatically resume when the call ends or you ignore the call.

Starting the voice assistant

You can use this product to control a voice assistance feature such as Siri or Google Assistant. This feature is available when you connect this product to a Bluetooth device that supports voice assistance.

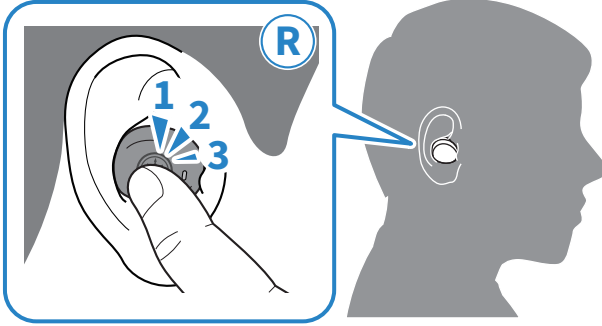

1 Press the function key on the earphone (R) three times in a row.

The voice assistant will start, and you can operate it using your voice.

NOTE

- The operations for the voice assistant feature will vary depending on your Bluetooth device. See the user's manual of your Bluetooth device for details.
- To finish listening to the voice assistant, operate your Bluetooth device.

Dedicated Application

Using the “Headphones Controller” app

The Headphones Controller smartphone app is a dedicated app for getting the best sound quality from your Yamaha earphones or headphones.

[Search tag] #Q03 App



This app will let you do the following.

- Show the status of your earphones/headphones (such as remaining battery power)
- Make detailed settings on your earphones/headphones

Install the app from the App Store (iOS devices) or from Google Play (Android devices). See the information about the app on each store for details.

App settings

This explains the settings and items you can check using the Headphones Controller app.

[Search tag] #Q03 App

NOTE

The app screen and items may differ, depending on your product.

Main screen



- LISTENING CARE

When LISTENING CARE is enabled, this product will automatically adjust the sound quality according to the playback volume. This feature adjusts the frequency balance, offering rich sound quality playback even at a low volume.

Settings

- ON (default setting): enables LISTENING CARE
 - OFF: disables LISTENING CARE
- Auto Power Off

Sets the time it takes for the power to turn off after Bluetooth has been disconnected.

Settings

- OFF
- 5min (default setting)
- 30min
- 1h
- 3h

Menu screen



- Confirm Firmware Update
Checks whether new firmware has been released, and performs updates.
- User Guide
Accesses the User Guide
- Google Analytics
Displays information regarding Google Analytics.

Troubleshooting

Read this first

If this product does not operate normally while you are using it, first check the following.

[Search tag] #Q01 Troubleshooting

- **Place both earphones back into the charging case and wait for at least 10 seconds, after which you can first take out earphone (R) and then earphone (L).**
- **Make sure that this product has been sufficiently charged.**
 - “Charging the earphones” (p.9)
 - “Charging the charging Case” (p.10)
- **Update the firmware of this product to the latest version.**
 - “Updating the firmware” (p.43)
- **Check the following items according to the trouble you are experiencing.**
 - “Cannot connect” (p.31)
 - “Power will not turn on” (p.32)
 - “The product cannot be charged” (p.33)
 - “The product does not operate or play back” (p.34)
 - “No sound can be heard” (p.35)
 - “Sound can only be heard from one earphone” (p.36)
 - “Sound is not good or sounds strange” (p.37)
 - “The sound is distorted, noisy or choppy.” (p.38)
 - “Using only one of the earphones” (p.39)
 - “Resetting and initializing the product” (p.40)

Cannot connect

● **The product is not pairing correctly.**

If the information for this product still remains in the list of connected devices on your Bluetooth device, delete that information and try pairing again.

- “Pairing with a Different Device” (p.18)

● **The information for a Bluetooth device that was registered on this product was deleted.**

If you pair a device beyond the maximum number of pairable Bluetooth devices, the information for device you first paired (the oldest pairing) is deleted. Pair this product once more.

- “Pairing with a Different Device” (p.18)

● **This product may already be connected to another Bluetooth device.**

On your Bluetooth device, remove the connection with this product and then connect this product again.

● **This product and your Bluetooth device may be too far apart.**

Move this product closer to the Bluetooth device.

● **A device that emits electromagnetic waves (such as a microwave oven, access point and so on) might be nearby.**

Do not use this product near other devices that emit electromagnetic waves.

Power will not turn on

● **There may not be enough battery power left.**

Charge this product.

- “Charging the earphones” (p.9)

● **The battery power of the charging case may have been depleted while charging the earphones.**

Turn on the power manually by holding down the function key on each earphone (L, R) until their indicators light blue. After this, charge the charging case.

- “Turning on the power” (p.12)

● **The product is temporarily not functioning in a stable way.**

Reset the earphone.

- “Resetting and initializing the product” (p.40)

The product cannot be charged

- **Your computer is not turned on (when charging from your computer).**
Turn the power of your computer on, and then charge this product.
- **You may have been using a USB power cable other than the one included with this product.**
Use the included USB power cable to make sure the product correctly charges.

The product does not operate or play back

● **The earphones are still charging.**

You cannot use this product while they are charging. Use the earphones after charging is finished.

● **There is not enough battery power.**

Charge the earphones.

- “Charging the earphones” (p.9)
- “Charging the charging Case” (p.10)

● **The product is temporarily not functioning in a stable way.**

Reset the earphone.

- “Resetting and initializing the product” (p.40)

No sound can be heard

● **The earphones are not connected to a Bluetooth device.**

Pair this product.

- “Pairing for the First Time” (p.15)
- “Pairing with a Different Device” (p.18)

● **The volume is too low.**

Raise the volume.

- “Playing back music on this product” (p.24)

● **The music stopped playing back.**

Start playback.

- “Playing back music on this product” (p.24)

Sound can only be heard from one earphone

● **The signal may not be coming in clearly, making the connection unstable.**

Move away from wireless devices such as access points, or appliances that produce electromagnetic waves such as microwave ovens. After placing both earphones into the charging case, take them out again.

● **You may be using a smartphone app that generates sound from only one channel.**

Check whether you can hear sound coming from both left and right channels by playing back sound from a different app.

● **One of the earphones might be turned off.**

Turn the power on.

- “Turning on the power” (p.12)

● **The connection information for the registered Bluetooth device may not be working properly.**

Delete the connection information of this product from the Bluetooth device, and then pair the earphones with the Bluetooth device.

- “Pairing with a Different Device” (p.18)

Sound is not good or sounds strange

● **You might be wearing the earphones on the wrong sides (L/R).**

Check that the left (L) and right (R) earphones are worn on the correct sides.

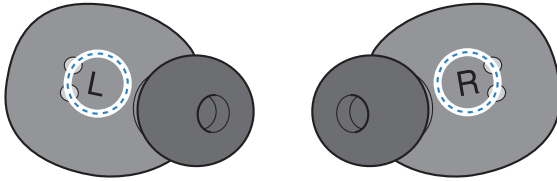

- “Putting on the earphones” (p.22)

● **The eartips don't fit my ears.**

Replace the eartips with the size that match your ear shape.

- “Replacing the eartips” (p.23)

The sound is distorted, noisy or choppy.

● **The signal may not be coming in clearly, making the connection unstable.**

Move away from wireless devices such as access points, or appliances that produce electromagnetic waves such as microwave ovens.

Try placing the connected Bluetooth device as close to this product as you can.

Devices with wireless network connectivity may transmit signals that obstruct Bluetooth communications. In this case, turn off the wireless network connectivity feature on your Bluetooth device.

● **The product is temporarily not functioning in a stable way.**

Reset the earphone.

- “Resetting and initializing the product” (p.40)

Using only one of the earphones

Pair the earphone you want to use with the Bluetooth device.

When doing this, note the following.

- This product does not offer a function to convert stereo sound to monaural sound.
- The L and R side function keys on the earphones work differently. For instance, you can only turn the volume up or down when you are using one earphone. When using only one earphone, use your Bluetooth device to operate controls like playback or talking on the phone.

Resetting and initializing the product

Follow the steps below to reset (restart) or reinitialize this product.

[Search tag] #Q04 Reset

Resetting

This resets (restarts) the earphones. The information for devices registered (paired) will still be retained.

- 1 Place the earphones (L, R) in the charging case.**
- 2 After at least 10 seconds, remove the earphone (R) from the charging case.**
- 3 Next, remove the earphone (L) from the charging case.**

Initializing

This will restore all of the earphone settings to their factory defaults. The information for devices registered (paired) will be deleted.

- 1 Place the earphones (L, R) in the charging case.**

The indicators light up red (when charging is completed, the indicators will turn off).

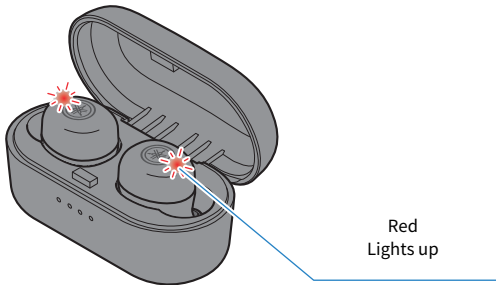

2 Hold down the function key on both earphones (L, R) for about seven seconds until their indicators flash purple.

After the indicators flash purple twice, they will light up red again.

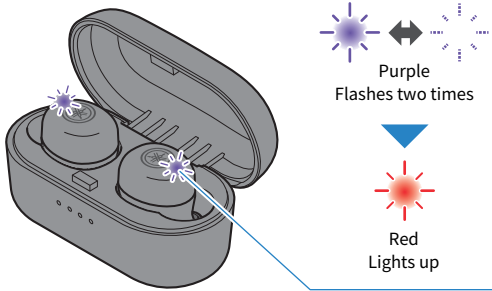

3 Remove the earphone (R) from the charging case.

Make sure that the indicator lights up as shown below.

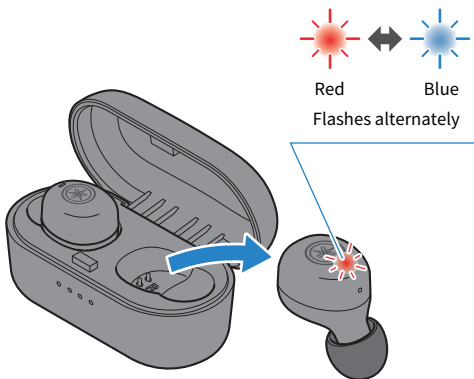

4 Remove the earphone (L) from the charging case.

After making sure that its indicator lights up purple for one second, follow the steps below.

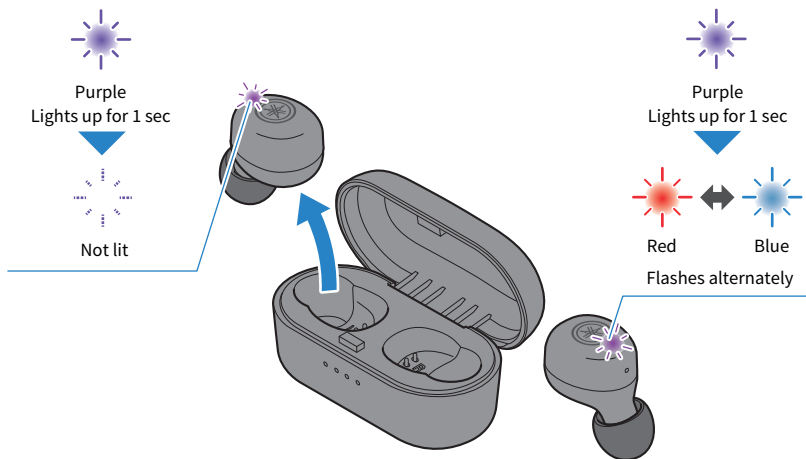

5 Place the earphones (L, R) in the charging case.

The earphones are now initialized.

Related links

“Pairing for the First Time” (p.15)

Updating the firmware

Update the firmware on this product with the Headphones Controller app.

The firmware on this product can be updated to add new functionality, rectify product issues and so on. For more details on the contents of updates, see the product information page on the Yamaha website.

NOTICE

- For stable data communication between this product and your Bluetooth device, update the firmware in a place where the signal is good. Do not do the following while the firmware is being updated.
 - Placing the earphones in the charging case
 - Turning the power of this product off
 - Closing the Headphones Controller app, or using another app
 - Turning your smartphone off
 - Canceling the connection between your smartphone and this product

1 On the main screen of the Headphones Controller app, open the menu.

2 Tap “Check for updates”.

If new firmware has been released, you will see instructions on how to perform the update. Install the firmware by following the instructions on the screen.

Related links

- “Using the “Headphones Controller” app” (p.27)
- “App settings” (p.28)

List of support centers

If the trouble still cannot be solved, please contact us for product support as shown below.

For customers within Japan

- Please contact the store where you purchased this product, or the Product Support Center as listed in the “Quick Start Guide” included with this product.

For customers outside of Japan

- Please contact your nearest authorized Yamaha dealer or service center.
<https://manual.yamaha.com/av/support/>

Appendix

List of operations

The main operations of this product are as shown below.

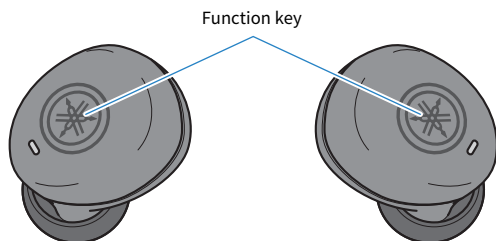

Power

- Power on
Function key on earphone (L and R; hold down for two seconds)
- Power off
Function key on earphone (L and R; hold down for five seconds)

Volume

- Volume up
Function key on earphone (R) (press quickly, two times in a row)
- Volume down
Function key on earphone (L) (press quickly, two times in a row)

Music playback

- Pause/play
Function keys on earphone (L) or (R)
- Skip to the next song
Function key on earphone (R) (hold down until you hear a “beep” sound)
- Go back to the beginning of the song, or skip to the previous song
Function key on earphone (L) (hold down until you hear a “beep” sound)
The operation may differ, depending on the Bluetooth device or app you use.

Phone calls

- Receive a phone call
Function key on earphone (R)
- End a phone call
Function key on earphone (R)
- Ignore a call
Function key on earphone (R) (hold down for at least two seconds)

Other functions

- Start pairing
Hold down the function keys on the earphones (L and R) with the power off (L earphone: two seconds; R earphone: five seconds).
- Start voice assistant
Function key on earphone (R) (press quickly, three times in a row)

List of indicator displays and audio messages

The indicator displays and audio messages on this product are shown below.

Earphone indicator display

- Power on
Lights up for 1 second (blue) and turns off
- Remaining battery power notifications
Flashes red three times: small amount of charge remaining
- Standby mode for pairing with Bluetooth device
Flashes (between red and blue alternately)
- Searching for paired Bluetooth device
Not lit
- Finished connecting to Bluetooth device
Lights up (blue, for approx. 20 sec) and turns off
- Power off
Lights for one second (red) and turns off
- Connection with earphone (L) and earphone (R) complete
Lights up for one second (purple) and turns off

Indicator display when charging

- Charging
Lights up (red)
- Charging completed
Not lit

Charging case indicator display

When the charging case is not connected to a power source

- For five seconds right after placing the earphones in the charging case
Shows the remaining battery power of the charging case and turns off

When the charging case is connected to a power source

- Shows the remaining battery power of the charging case

Audio messages

- Battery High
Plenty of battery charge remaining
- Battery Medium
Moderate battery charge remaining
- Battery Low
Small amount of battery charge remaining
- Power Off
Power off
- Pairing
Start pairing (device registration)
- Pairing Successful
Pairing successful/finished connecting
- Pairing Failed
Pairing unsuccessful
- Connected
Finished connecting to Bluetooth device
- Disconnected
Disconnected from Bluetooth device

Related links

- “Charging the earphones” (p.9)
- “Charging the charging Case” (p.10)
- “Turning on the power” (p.12)
- “Turning off the power” (p.13)
- “Remaining Battery Power” (p.14)
- “Pairing for the First Time” (p.15)
- “Pairing with a Different Device” (p.18)
- “Connecting to a Device Already Paired” (p.21)

Specifications

The specifications of this product are as shown below.

- Driver type
Dynamic
- Driver unit
6.0 mm
- Frequency range
20–20,000 Hz
- Bluetooth version
5.0
- Supported profiles
A2DP, AVRCP, HFP, HSP
- Supported codecs
SBC, AAC, Qualcomm® aptX™
- Supported content protection (Japan only)
SCMS-T
- RF output power
Class 1
- Maximum communication range
10 m (33 ft) (without obstructions)
- Maximum number of pairable devices
3

Rechargeable battery

- Internal rechargeable battery
Lithium-ion battery
- Charging time (to full capacity)
Earphones: approx. 2 hours
Charging case: approx. 2 hours
- Continuous playback time
Approximately 6 hours
Number of earphone charging cycles available with charging case (when charging case is fully charged)
Approx. 3 times
- Temperature range for usage (when charging)
5–40°C
Charge this product within the listed temperature range.

General

- Waterproof rating
IPX 5 (earphones)
- Weight
5.0 g (per earphone)

Trademarks

The trademarks used in this documentation are as follows.

The Bluetooth® word mark and logos are registered trademarks owned by Bluetooth SIG, Inc. and any use of such marks by Yamaha Corporation is under license. Other trademarks and trade names are those of their respective owners.

Qualcomm aptX is product of Qualcomm Technologies, Inc. and/or its subsidiaries.

Qualcomm is a trademark registered by Qualcomm Incorporated in the U.S.A. and other countries. aptX is a trademark registered by Qualcomm Technologies International, Ltd. in the U.S.A. and other countries.

Android™ and Google Play™

Android and Google Play are trademarks of Google LLC.

App StoreSM

The App Store is a service mark of Apple Inc.

Siri®

Siri is a trademark registered by Apple Inc. in the U.S.A. and other countries.

Yamaha Global Site
<https://www.yamaha.com/>

Yamaha Downloads
<https://download.yamaha.com/>

Manual Development Group
© 2021 Yamaha Corporation

Published 05/2021 AMOD-C0

AV20-0112