

USER MANUAL

Stainless Steel Litter Box



MESSAGE TO OUR VALUED CUSTOMERS

Thank you for choosing our cat litter box. We are doing our best to make life easier for you and your cats.

Please read this user manual carefully before using. You are supposed to find detailed instruction about every aspect of our cat litter box.

SPECIFICATION

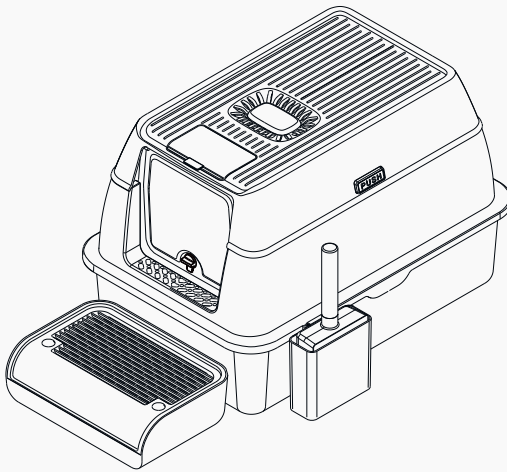

Weight: 3.9kg

Material: Stainless Steel + PP + ABS

Maximum Litter Capacity: 37L

Litter Replacement Period: 30 days for 1 cat, 15 days for 2 cats

Optimal Amount Of Cat Litter: About 1.5" thick when spread evenly

HOW TO GET YOUR CAT USED TO THE LITTER BOX QUICKLY

Put the cat's used litter and its excrement into the new litter box. Let the cat have a familiar feeling of the new toilet.

WHAT'S IN THE BOX

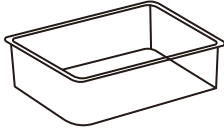

Stainless Steel Pan

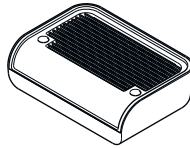

Footboard

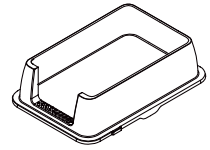

Medium Shell

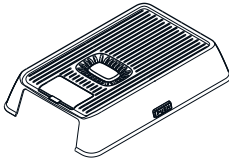

Top Cover

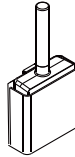

Litter Scoop Holder

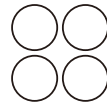

Non Slip Feet



User Manual



Charcoal Filters

HOW TO ASSEMBLE

Method 1:

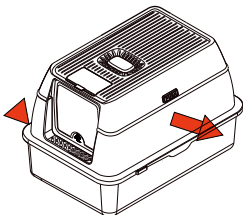

- 1** Place the enclosure over the metal pan and align the edge. Pull the two snaps on each side slightly to the outside.

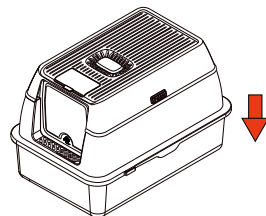

- 2** Press down on the snaps.

Method 2:

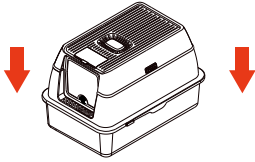

- 1 Place one side of the enclosure over the metal pan, pull the snap outward and press down. A "click" indicates that the installation is complete.

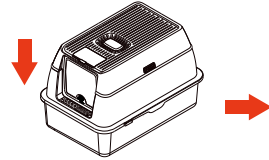

- 2 Then pull the snap on the other side outward and press down.

SCOOP HOLDER STICKER: Paste the sticker to the holder (please mind the direction), and hang it on the wall or the enclosure.

NON-SLIP STICKER: Paste the non-slip stickers on the 4 corners of the bottom of the pan.

HOW TO REMOVE THE ENCLOSURE

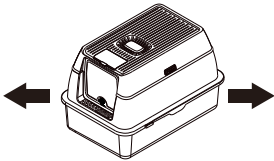

- 1 Lift it up to take it out Pull the snap in the middle of the enclosure to both sides slightly, and then upper cover.

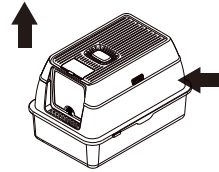

- 2 To open the upper cover, press the "**PuSH**" button on the left and right of the upper cover to remove the upper cover.

Pull the snaps on both side of enclosure slightly, and then lift it up.

INSTALL THE BAMBOO CHARCOAL PACKET

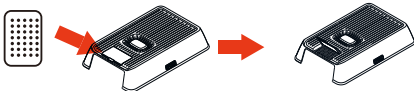

Flip the lid over to open the lid of the box, put the charcoal bag into the box, and fasten the lid.

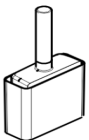

Hang the box in the square hole of the upper shell and place the shovel inside the box