

TeraStation 5000 and 5000N

User Manual

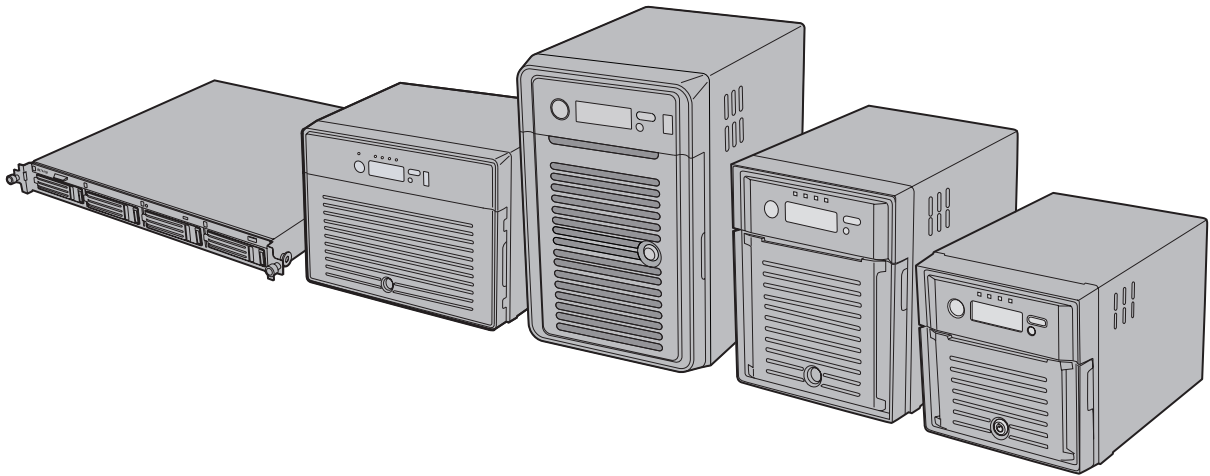

Americas: www.buffaloamericas.com

Europe: www.buffalo-technology.com

Asia Pacific: www.buffalo-asia.com

35020018-12
2015.07

Contents

Chapter 1 Installation.....	9
Diagrams.....	9
Turning the TeraStation On and Off.....	12
Changing the Administrator Password	14
Creating a Recovery Drive	16
For Initializing Settings	16
For Resetting Password	17
Chapter 2 Configuration	18
Opening Settings	18
Opening Easy Admin	20
Chapter 3 Access Restrictions.....	22
Adding a Shared Folder	22
Adding Users	25
Importing User Information.....	26
Adding Groups	27
Configuring Access Restrictions	29
Local Users and Groups	29
Active Directory	30
NT Domain.....	33
User Authentication with an External SMB Server.....	35

Chapter 4 Managing Storage..... 39

RAID Arrays.....	39
Working with RAID Arrays	40
Using JBOD.....	41
Changing RAID Mode	41
Configuring a Hot Spare.....	43
RMM (RAID Mode Manager).....	44
RAID Scanning.....	46
Adding an External Hard Drive	47
Connecting an External Drive	47
Compatibility	47
Dismounting Drives	48
Checking Drives	49
S.M.A.R.T.	50
Formatting Drives	51
Encrypting Drives.....	54
Media Cartridges.....	54
Erase Data on the TeraStation Completely.....	55
Disk Quotas	56
Quotas for Users.....	56
Quotas for Groups	57
Size Limits.....	58
Using the TeraStation as an iSCSI Device	60
Introduction	60
Creating a iSCSI Volume	61
Connecting or Disconnecting Volumes.....	63
Configuring Access Restrictions	69
Expanding Volume Sizes	77

Deleting Volumes.....	78
Hard Drive Replacement	80
Hard Drive Replacement Examples	81
<u>Chapter 5 Backup</u>	<u>86</u>
Back Up from the TeraStation	86
Preparing a Backup Destination.....	86
Configuring a Backup Job	88
Replication.....	92
Preparing a Replication Destination	92
Configuring a Replication Task	93
Failover	96
Ethernet Cable Connection Methods	96
Usage Restrictions	98
Configuration	98
Additional Settings.....	99
When the Main TeraStation Fails	100
Backing Up Your Mac with Time Machine	100
Copying from a USB Device	105
<u>Chapter 6 Remote Access.....</u>	<u>107</u>
WebAccess	107
WebAccess Remote	109
FTP.....	111
Cloud Storage	112
Configuring Cloud Storage	112
Uploading Files to Cloud Storage.....	114

Chapter 7 BitTorrent..... 119

Chapter 8 Multimedia 122

DLNA 122

- Playing Files 123**
- Connected DLNA-compatible Devices 123**
- Streaming to DLNA-compatible Devices 124**
- Disabling Playback from Specific Devices 125**

iTunes Server 126

Squeezebox Server 128

Chapter 9 Surveillance Server 131

Getting Started 131

- Installing Client Tools 132**
- Connecting Devices to the Network..... 132**
- Enabling Surveillance Cameras 132**
- Enabling the Free License 134**
- Registering Recording Policies 136**
- Checking Recording..... 141**
- Viewing Saved Video 142**

Advanced Usage..... 142

- Export Recorded Data as a MOV Video File 142**
- Viewing Video Real-time 145**
- Moving Recorded Video Data to Another TeraStation..... 146**
- Backing Up Recorded Video to Another TeraStation 147**
- Automatically Delete Old Data when Space is Low..... 148**
- Changing Where Recorded Video Is Saved 150**
- Email Notification 150**

Client Tools	151
Camera Policies	151
Live Viewer	151
Data Service Policies.....	152
Vault Admin.....	153
Surveillance Video Manager	154
Network Activity	155
Mini Vault Stats	156
Activating Additional Licenses	156
When the TeraStation is Connected to the Internet.....	156
TeraStation Not Connected to the Internet	158
Troubleshooting.....	162

Chapter 10 Advanced Features **164**

Antivirus Software	164
Licenses	164
Activating Virus Scanning	165
Configuring Security Settings	165
Connecting through a Proxy Server	166
Updating.....	167
Excluding a Specific Folder from Antivirus Scanning	168
Virus Scanning	168
Checking the Log	169
Online Help.....	170
Email Notification	171
Sleep Mode	172
Wake-on-LAN	174
UPS (Uninterruptible Power Supply)	175

Port Trunking	176
Configuring Port Trunking	177
Connecting a Printer	178
Setting Up a Printer with Windows 8.1, Windows 8, Windows 7, or Windows Vista	178
Setting Up a Printer with Windows XP	179
TeraSearch	180
Offline Files	181
DFS	184
Accessing from an NFS Client	186
Encrypting Data Transmission	188
Encrypting Settings Data	188
Encrypting FTP Transfer Data	188
SSL Keys	189
Web Server	189
MySQL Server	191
SNMP	192
Saving and Applying Settings	193
Saving Settings	193
Applying Settings	194
Restoring Factory Defaults	195
Initializing from Settings	195
Creating an Initialization Drive	196
Initializing with the USB Drive	196
Resetting the Administrator Password	197
Creating a Password Reset Drive	197
Resetting with the USB Drive	197
Logs	197

Updating the Firmware.....	199
Updating Manually.....	199
Updating Automatically.....	199
Name, Date, Time, and Language	200
Beep Alerts	203
LCD and LEDs.....	203
Jumbo Frames	204
Changing the IP Address	206

Chapter 11 Utilities..... 208

NAS Navigator2 for Windows.....	208
Mount as Network Drive.....	210
Changing the IP Address	211
NAS Navigator2 for Mac	212
Mount as Network Drive.....	214
Changing the IP Address	214
iSCSI Connection Tool	215
Home Screen	216
Menu	217
NovaBACKUP	217

Chapter 12 Appendix 219

LCD Display.....	219
Modes	219
Errors.....	219
Status	220
Default Settings	222

Specifications 223

Chapter 13 Regulatory Compliance Information... 225

For Customers in the United States 225

For Customers in Europe 225

For Customers in Korea..... 227

For Customers in Taiwan..... 228

For Customers in China..... 228

For Customers in Russia..... 228

Chapter 1 Installation

Diagrams

TS5800D, TS5800DN, TS5800DWR

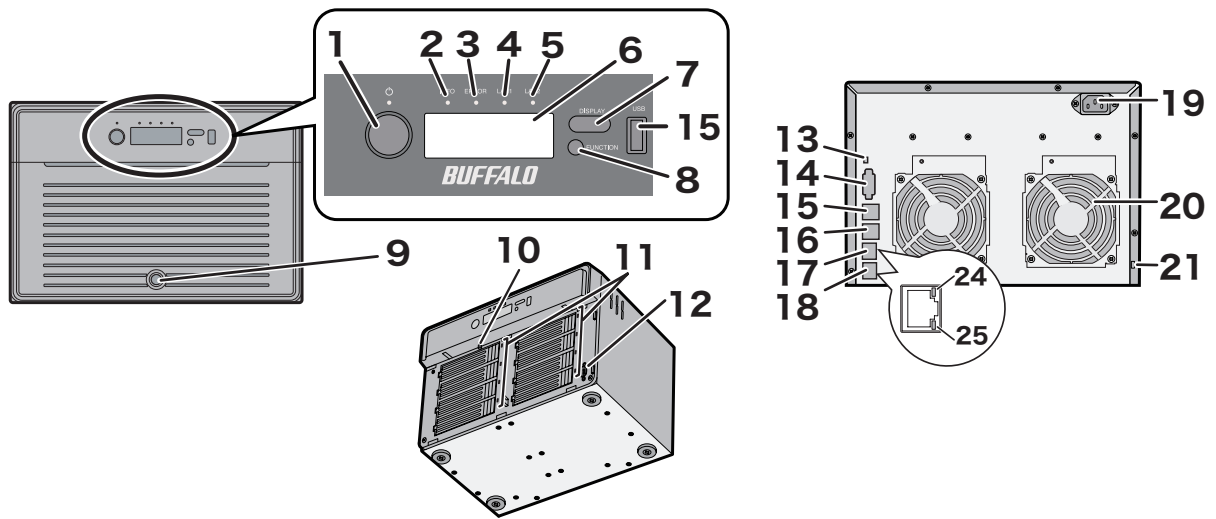

TS5600D, TS5600DN

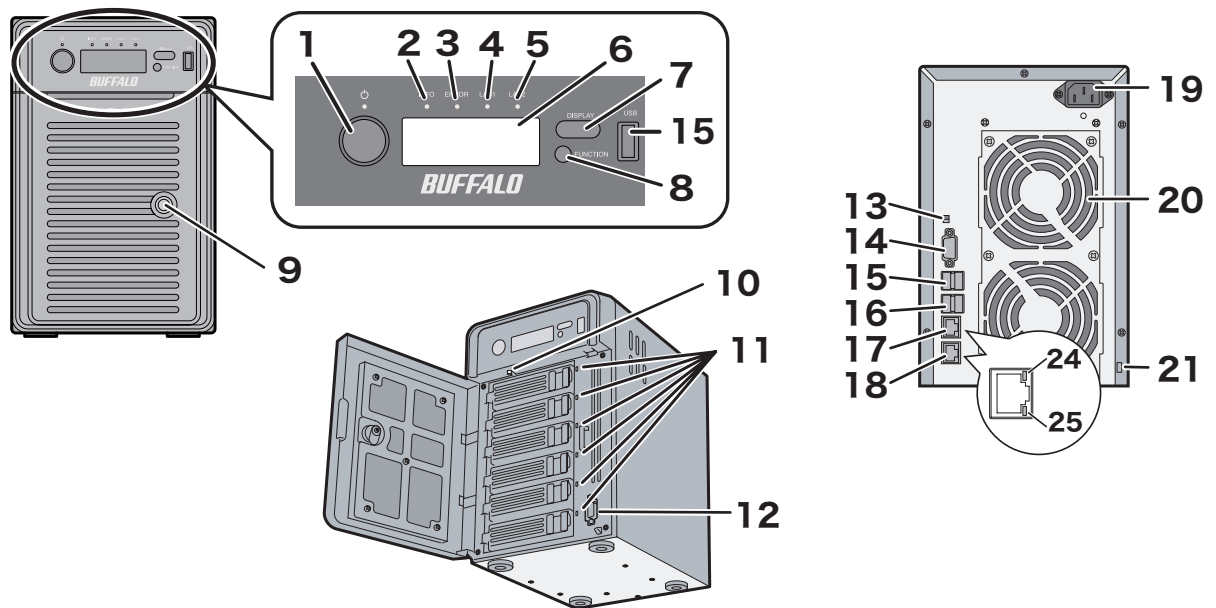

TS5400D, TS5400DN, TS5400DWR

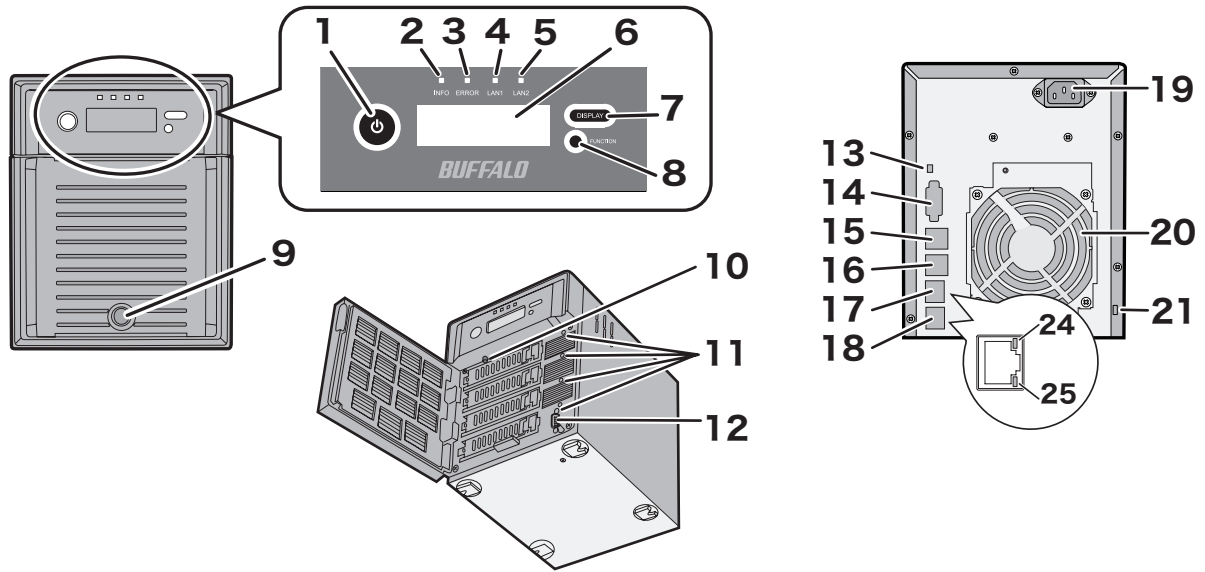

TS5200D, TS5200DN, TS5200DS, TS5200DWR

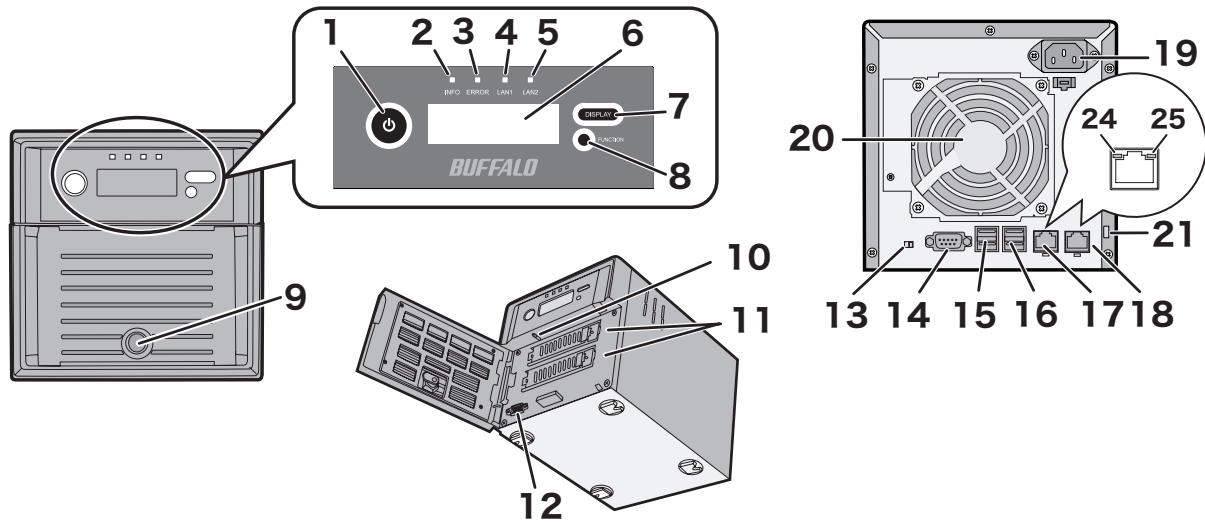

TS5400R, TS5400RH, TS5400RN, TS5400RWR

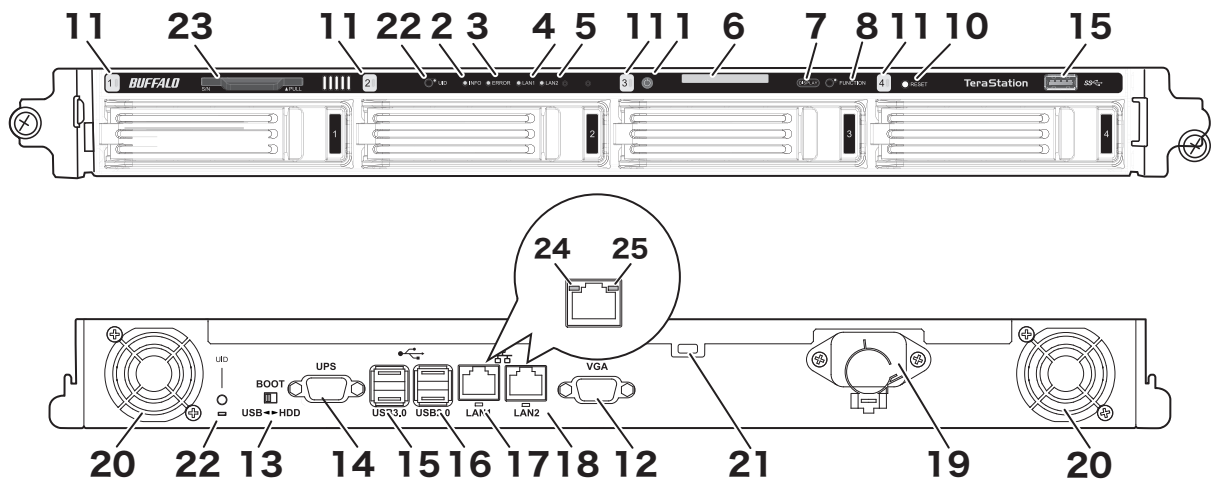

1 Power Button

To power on, connect the power cable and wait for 10 seconds, then press the power button. To power off, press the power button twice.

2 Info LED

If there is a status message, the amber info LED will light up. Check the LCD panel to see the status message.

3 Error LED

If there is an error, the red error LED will light up. Check the LCD panel to see the error message.

4 LAN1 LED

When LAN port 1 is connected, this LED glows green. It blinks when the connection is active.

5 LAN2 LED

When LAN port 2 is connected, this LED glows green. It blinks when the connection is active.

6 LCD Panel

This display shows the status of many TeraStation settings. It also displays errors and messages when available.

7 Display Button

Switches between the different display modes. Also, if the TeraStation is beeping, press this button to stop it.

8 Function Button

Use this button for Direct Copy, dismounting USB devices, rebuilding RAID arrays, and configuring failover.

9 Drive Lock

Open the front panel with the key to replace hard drives or access the reset button.

10 Reset Button

To shut down and reboot the TeraStation, hold down the reset button.

11 Status LEDs

Normally, these LEDs blink green when hard drives are accessed. If a drive fails, its LED will turn red or amber.

12 Factory Use Only

13 Boot Mode Switch

Leave the switch in the HDD position during normal operation. To recover settings, insert the recovery USB drive into a USB 2.0 port, move the boot switch to the USB position, and press the power button.

14 UPS Port

Connect to a UPS.

15 USB 3.0 Port

Compatible Buffalo USB 3.0 hard drives can be connected. USB hubs are not supported.

16 USB 2.0 Port

Compatible Buffalo USB hard drives, USB flash drives, digital cameras, and USB UPS connections can be connected. USB hubs are not supported.

17 LAN Port 1

Use an Ethernet cable to connect this port to your network.

18 LAN Port 2

This second Ethernet port may be used for network redundancy or backup. You may connect a second TeraStation directly to this port for backup.

19 Power Connector

Use the included power cable to connect to an UPS, surge protector, or outlet.

20 Fan

Do not block the fan.

21 Anti-Theft Security Slot

Use this slot to secure your TeraStation with a cable lock (not included).

22 UID Button

Press the UID button on the front or the back of the unit to cycle the blue LED on and off.

23 Serial Number

This sticker shows the TeraStation's serial number.

24 Link LED

Glow orange when the unit is connected to a network.

25 Act LED

This LED shows network activity. It blinks orange when the TeraStation is accessed over the network.

Turning the TeraStation On and Off

Press the power button on the TeraStation to turn it on.

To turn off the TeraStation, press the power button twice. Don't unplug the TeraStation without turning it off first.

You can also shut it down and restart it remotely from Settings.

Shutting Down or Restarting from Settings

1

Double-click the  icon.

- 2 Right-click your TeraStation's icon and select *Settings*. For Mac OS, select the TeraStation's icon while holding down the control key, then select *Settings*.

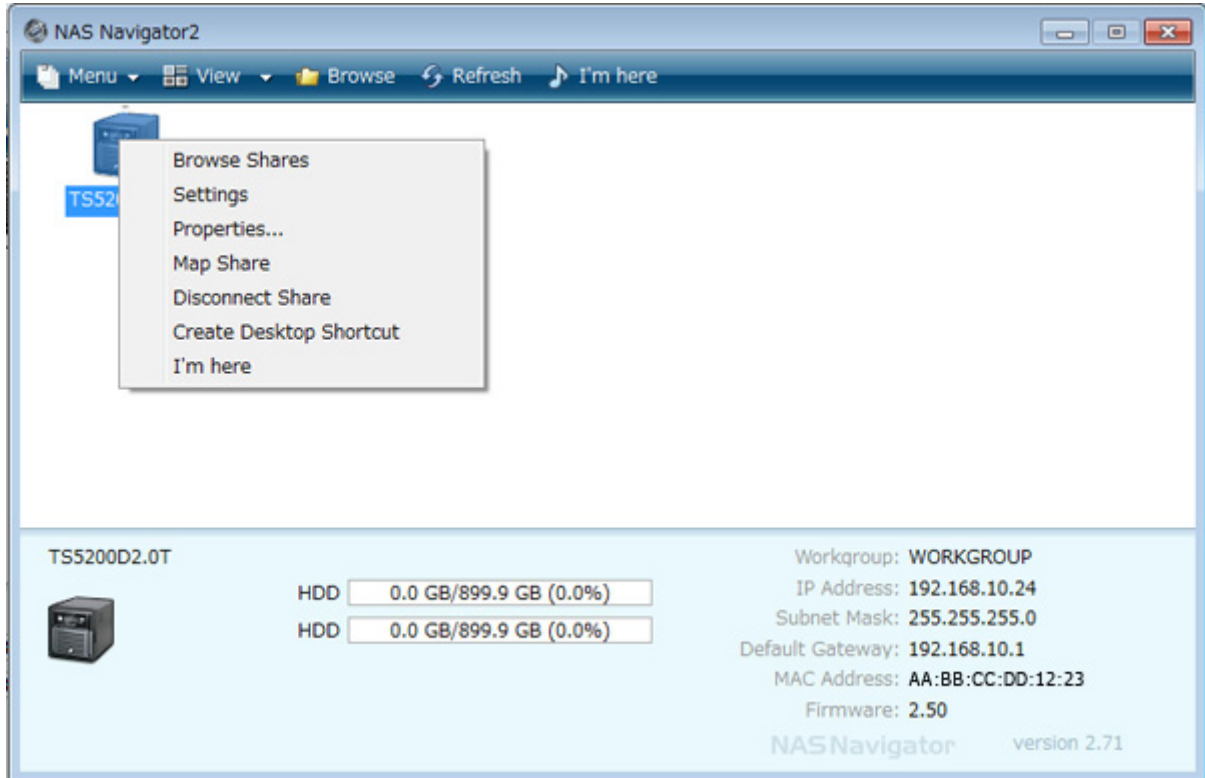

- 3 Enter the username and password, then click *OK*.

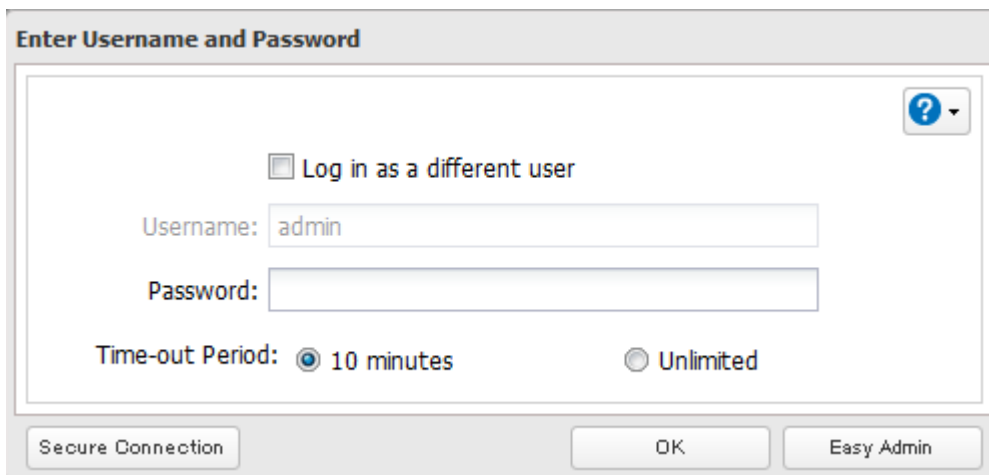

Note: The default username and password are "admin" and "password".

4 Settings will open.



5 Click  at the top-right of Settings and choose either *Restart* or *Shut Down*.

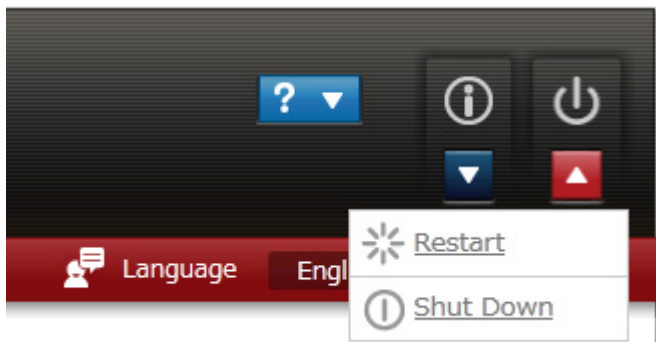

When all the LEDs on the front of the TeraStation turn off, the shutdown process is complete.

Changing the Administrator Password

After initial setup, follow this procedure to change your password.

1 Double-click the  icon to start NAS Navigator2.

- 2 Right-click on your TeraStation's icon and select *Settings*. On the Mac, select the TeraStation's icon while holding down the control key, then select *Settings*.

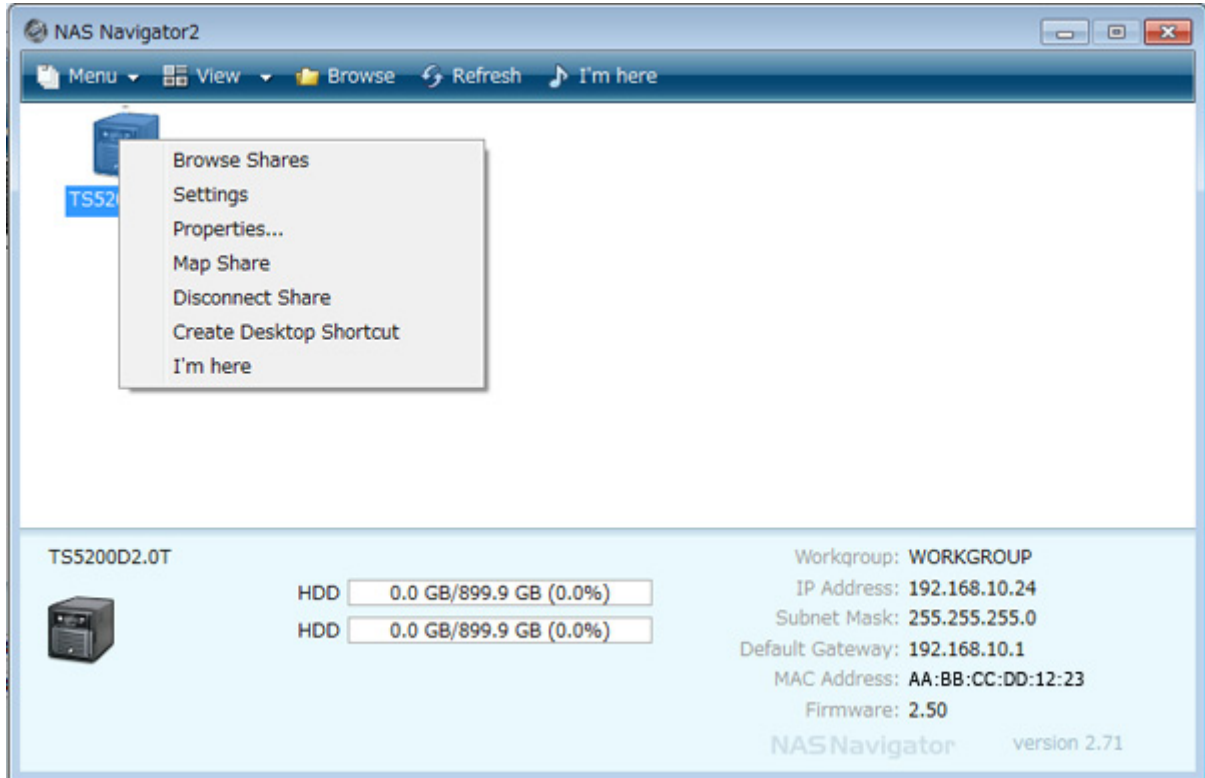

- 3 Click *Easy Admin*.

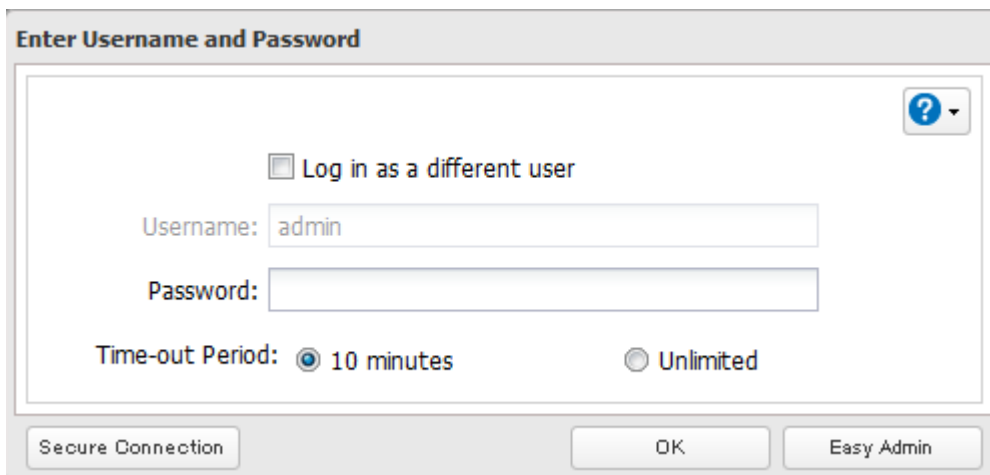

- 4 Click *Change Password*.

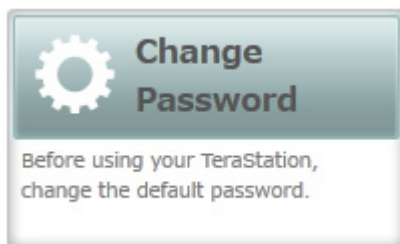

- 5 If this screen is displayed, enter the current password and click *OK*. The default password is "password".

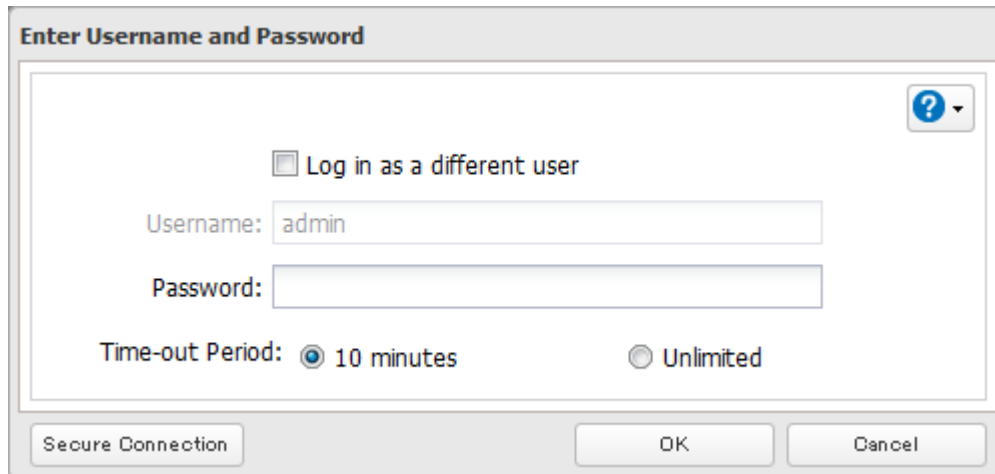

- 6 Enter the new password (twice) and click *Next*.

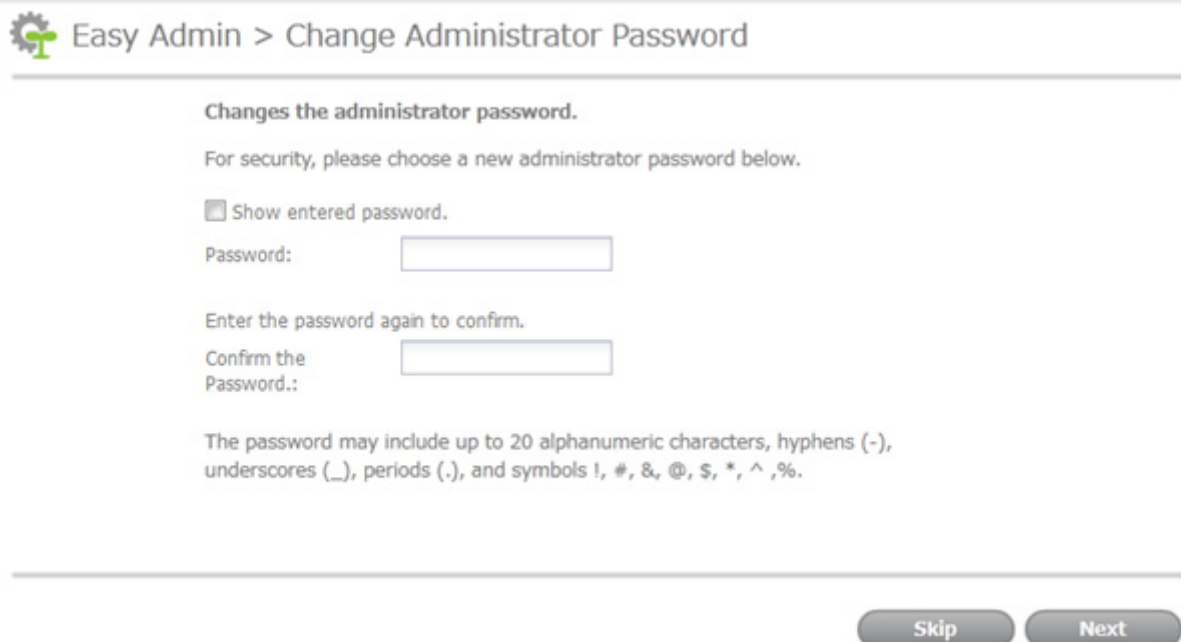

- 7 Click *OK*. You have changed the admin password.

Creating a Recovery Drive

To initialize all of the TeraStation's settings, or just restore the admin password to its factory default value, create the recovery drives as described below.

For Initializing Settings

A system initialization drive can reset all settings to their default values.

Notes:

- Normally, creating and using a system initialization drive will not affect data on the TeraStation. However, always back up your data regularly!
- This USB drive can be used to recover the system if your TeraStation doesn't boot at all. In this case, if the data partition is damaged, then all your data will be deleted by the recovery process.

- 1** Insert a 1 GB or larger USB flash drive into a USB port on the TeraStation.
Note: All data on the USB flash drive will be erased!
- 2** In Settings, navigate to *Management - Restore/Erase - USB Options*.
- 3** Select *Create a USB drive for initializing settings*.
- 4** Select the USB memory device from "Target USB drive", then click *Execute*.
- 5** Enter the 4 digit confirmation number and click *OK*. The TeraStation will create the initialization drive. This will take about a minute.
- 6** When the "finished" dialog opens, the USB initialization drive is ready to use. Dismount the USB drive before unplugging it. See "Dismounting Drives" in chapter 4 for the instructions on dismounting drives.

For Resetting Password

A password initialization drive can reset the administrator password to its default value ("password"). This could be very useful if you forget your admin password.

- 1** Insert a 1 GB or larger USB memory device (not included) to a USB 2.0 port on the TeraStation.
Note: All data on the USB flash drive will be erased!
- 2** In Settings, navigate to *Management - Restore/Erase - USB Options*.
- 3** Select *Create a USB drive for resetting the admin password*.
- 4** Select the USB memory device from "Target USB drive" list, then click *Execute*.
- 5** Enter the 4 digit confirmation number and click *OK*. The TeraStation will create the password reset drive. This will take about a minute.
- 6** When the "finished" dialog opens, the password reset drive is ready to use. Dismount the USB drive before unplugging it. See "Dismounting Drives" in chapter 4 for the instructions on dismounting drives.

For instructions on using system initialization or password initialization drives, see chapter 10.

Chapter 2 Configuration

Configure and manage your TeraStation using the Settings interface, accessible from a browser window. Open the interface using the procedure below or type the TeraStation's IP address in the URL field of your browser. Within Settings, the Easy Admin page gives you quick access to commonly used settings.

Note: Internet Explorer 9, Firefox 18, Google Chrome 24, Safari 5, and later are supported. If you have difficulty viewing Settings, check the following:

- If there are a large number of registered users, groups, or shared folders, use Firefox instead of Internet Explorer.
- If you have a proxy server enabled in the browser settings, disable the proxy server.
- With Internet Explorer, set security to *Local intranet*. On Windows Server 2008 or later version Windows OS, higher-level security is configured by default. Set the security to a lower level temporarily.

Opening Settings

- 1 Double-click the  icon to start NAS Navigator2.
- 2 Right-click on your TeraStation's icon in NAS Navigator and select *Settings*. For Mac OS, click your TeraStation's icon while holding down the control key, then select *Settings*.

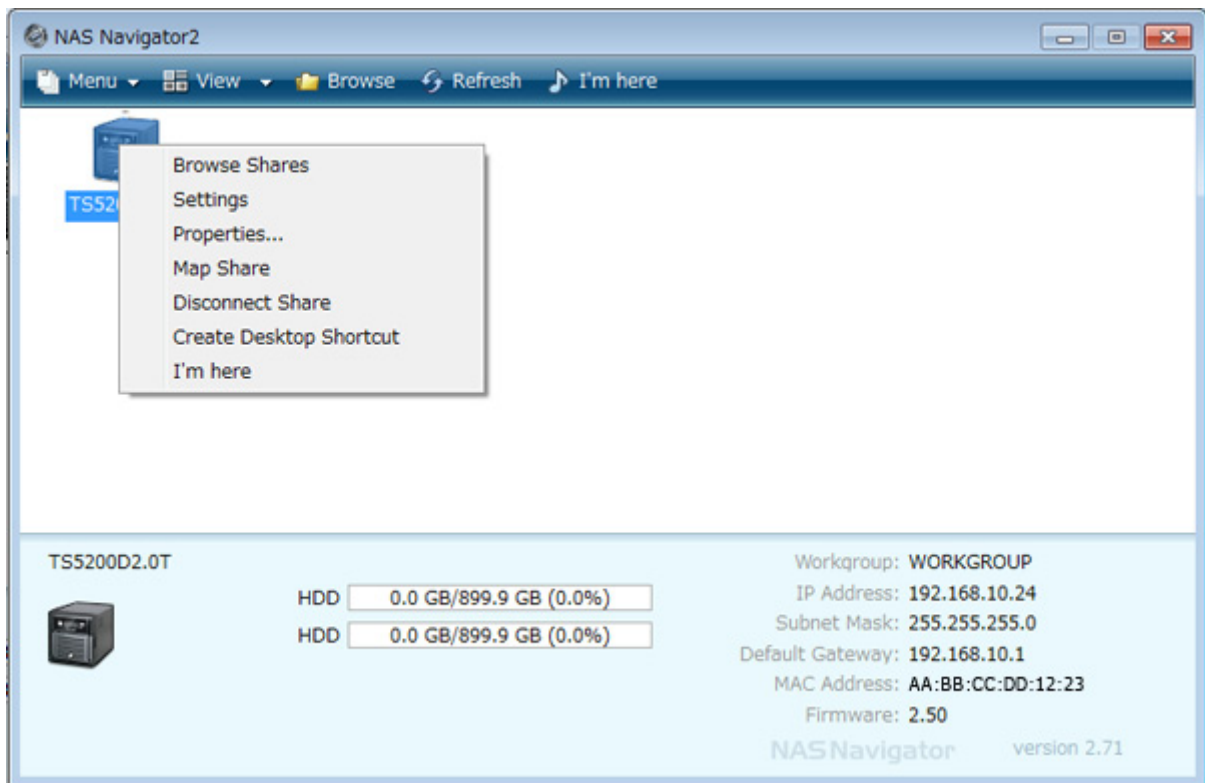

- 3 Enter the username and password and click *OK*.

Notes:

- If the time-out period is set to "10 minutes", you will be logged out of Settings after 10 minutes of inactivity.
- Click *Secure Connection* to log in with an encrypted connection.



- 4 Settings will open.



Notes:

- Username/Password Combinations:

Username	Password	Settings Available
admin	password	All
guest	blank	System information (read-only)
Your username	Your password	If a user is assigned as an administrator, all settings are available. If assigned under another group, only system information (read-only) is available.

- Click  to open Easy Admin.
- Click  to play a tone from the TeraStation for easy location.
- You can also use Bonjour to log in to Settings from OS X 10.4 or later. In Safari, click *View - Show Bookmarks Bar*. From Bookmarks, click *Bonjour - TeraStation name*.

Opening Easy Admin

The Easy Admin page makes it easy to change common settings. Follow the steps below to open Easy Admin.

- 1 Double-click the  icon to start NAS Navigator2.
- 2 Right-click on your TeraStation's icon and choose *Settings*. For Mac OS, click the TeraStation icon while holding down the control key, then select *Settings*.

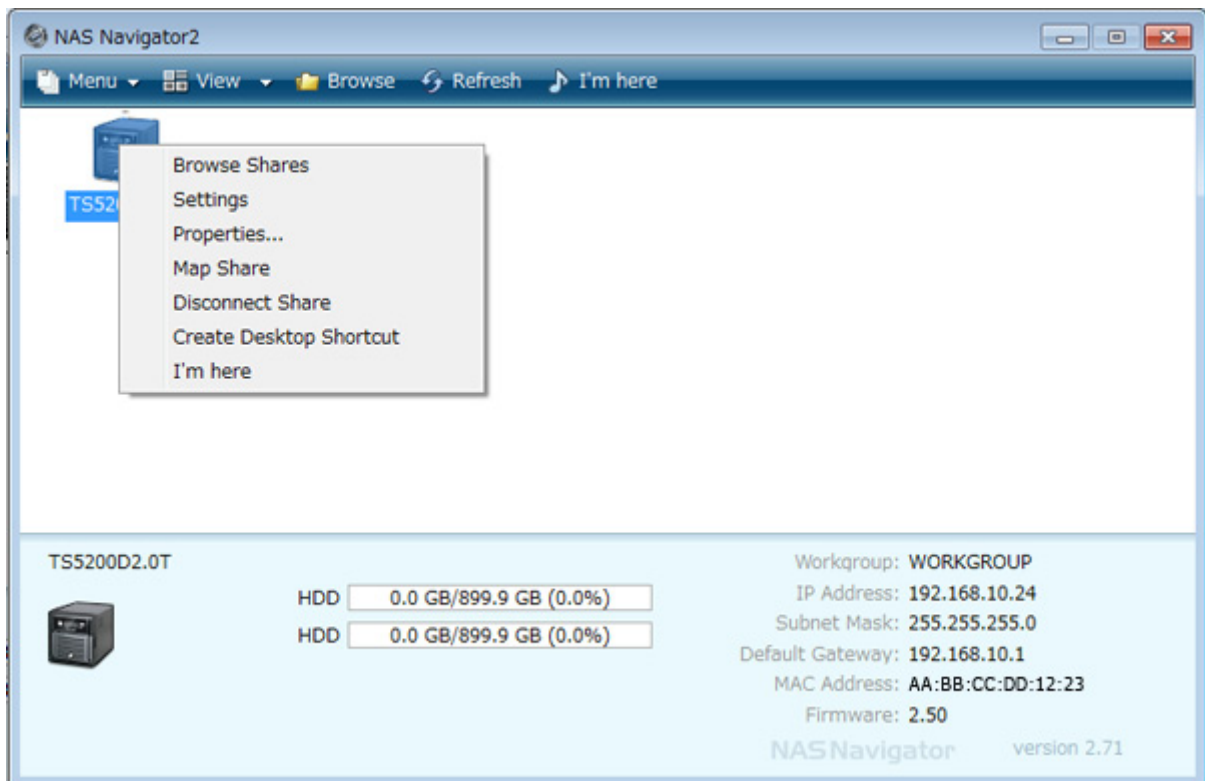

3 Click *Easy Admin*.

Enter Username and Password

Log in as a different user

Username:

Password:

Time-out Period: 10 minutes Unlimited

Secure Connection OK Easy Admin

4 The Easy Admin screen will open.

BUFFALO
TeraStation

Name : TS5200D4E1 (TS5200D) admin Language English Log Out

Easy Admin

- WebAccess**
Create a free personal cloud and access and share your files anytime, anywhere over the Internet.
- Access Restrictions**
Create users, groups, and new folders.
- RAID Settings**
Change RAID settings.
- Active Domain**
Enable to sync TeraStation with Active Directory domain.
- Backup**
You can back up files on the TeraStation to an attached USB drive or to another folder on the
- TeraSearch**
Search all documents in TeraStation.
- Change Password**
Before using your TeraStation, change the default password.

Advanced Settings All TeraStation functions can be configured from Advanced Settings.

Copyright © 2013 Buffalo Inc.

Notes:

- If you click any buttons , you will need to enter a username and password.
- In Advanced Settings, click the  icon at the top left to open Easy Admin.

Chapter 3 Access Restrictions

You may restrict access to specific shared folders, including external USB drives.

Notes:

- Access restrictions can be set separately for each shared folder, but not for folders within the shared folders.
- Configure access restrictions through Settings. Configuring access restrictions through Windows is not supported and may cause unexpected behavior.
- You can also configure users, groups, and shared folders from Easy Admin by clicking *Access Restrictions*.
- Shared folders with limited access can still be used as backup destinations.
- If you change access restrictions for a user or group while they are accessing files, unexpected behavior may result.

Adding a Shared Folder

- 1** In Settings, click *File Sharing*.

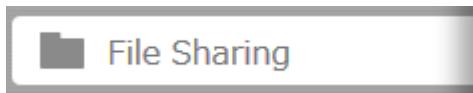

- 2** Click  to the right of "Folder Setup".

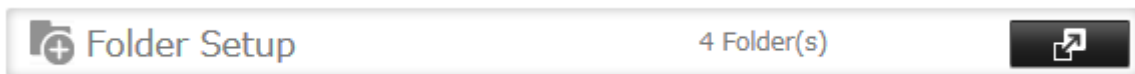

- 3** Click *Create Folder*.

4 Configure the desired settings, then click OK.

Shared Folder Settings

* Required ?

Copy settings from: [dropdown]

Name * : [text box]

Shared Folder Description: [text box]

Volume: Disk 2 [dropdown]

Attribute: Read Only Read & Write

Recycle Bin: Enable Disable

LAN Protocol Support: SMB (Windows/Mac) AFP (Mac)
 FTP Backup
 DLNA WebAccess
 SFTP
 NFS

NFS Path
/mnt/disk2/

Folder Attributes: Hidden Share (SMB Only)
 Windows Backup

Remote Backup Password: [text box]

WebAccess Public Mode: Allow Anonymous [dropdown]

Offline Files: Manual File Caching [dropdown]

TeraSearch: Include this folder in the search index

Virus Scan: Real Time Scan
 Scheduled Scan
 Manual Scan

Access Restrictions: Enable Disable

Local Users Local Groups Domain Users Domain Groups External Users

Filter: [text box] X

Local Username	W	R	
guest	<input type="radio"/>	<input type="radio"/>	<input checked="" type="radio"/>
admin	<input type="radio"/>	<input type="radio"/>	<input checked="" type="radio"/>

OK Cancel

Notes:

- Names may contain up to 27 alphanumeric characters, hyphens (-), and underscores (_). Do not use a symbol as the first character in a name.
- The description may contain up to 75 alphanumeric characters, hyphens (-), underscores (_), and spaces. Do not use a symbol or space as the first character.
- You may create up to 400 shared folders.
- The names of shared folders should not use characters from more than one language. For example, mixing Japanese and Korean characters in names is not supported.
- If multi-byte characters are used in shared folder names, configure the client language to match the characters in *Management - Name/Time/Language*.

- The following characters are handled differently by Mac OS and Windows. Avoid using these characters when sharing data between Mac OS and Windows: `~ || - Ⓢ ↩`
- Windows does not support some characters that Mac OS and the TeraStation allow. If you create a filename on a Mac with any of the following characters, it will not display correctly on a Windows computer. With OS X 10.2 or later, you may have to connect to the TeraStation via AFP in order to display or copy any of the following characters:
`? [] / \ = + < > ; : " , | *`
- Do not use any of the following words as the name of a shared folder. These words are reserved for internal use by the TeraStation: info, spool, lost+found, global, printers, homes, lp, authtest, ram, msdfs_root, mt-daapd, usbdisk# (where # is a number, for example: usbdisk1)
- Don't use the following unsupported characters in shared folder names, workgroup names, or filenames:

- File and folder names may contain up to 255 single-byte characters.
- Configure hidden and read-only file attributes in Settings. Configuring them from within Windows is not supported and may cause unexpected behavior.
- Folder and workgroup names whose names contain non-Roman characters may not be displayed correctly.
- If shared folders are accessed from a Mac, information files for the Mac may be generated automatically. Do not delete these files. If they are deleted using Windows, this may prevent further access from a Mac.
- If an SMB connection is used with OS X 10.3.9, the names of mounted volumes may appear as unreadable characters in Finder and other applications. This is not a problem with the filename or data.
- With OS X 10.5 to 10.5.6, Spotlight searches are not supported over AFP connections. Use SMB connections or upgrade to OS X 10.5.7 or later.
- The TeraStation belongs to the default zone in AppleShare; the zone cannot be specified.
- When files are copied to the TeraStation or to a USB drive connected to the TeraStation, file information such as date created, date modified, and other date information may be updated or changed.
- During a file transfer, if settings are changed, the file transfer operation may be aborted.
- File copying to the TeraStation is protected by a journaling file system. If the Ethernet cable is disconnected or a power outage occurs while copying data, the following may occur:
 - Preset data such as the TeraStation name, users, and groups may be erased.
 - An incomplete file may be copied and the file can no longer be deleted. If this happens, restart the TeraStation, delete the file, and perform the copy operation again.
- The details for a shared folder may show that offline files are enabled for the folder even when they are disabled for all folders. However, offline files really were disabled correctly; it is only the details that are wrong. This behavior will be corrected in a future firmware update.

Recycle Bin

To protect your data from accidental deletion, you may configure your TeraStation to use a recycle bin instead of deleting files immediately. The recycle bin will only work with SMB connections. To empty the recycle bin, click *File Sharing - Folder Setup - Empty Recycle Bin* in Settings.

Notes:

- You can prevent guests and other users from emptying the trash by navigating to *File Sharing - SMB - Recycle Bin Permissions* and selecting "Administrator only".
- If you use Mac OS, enable "Exclude Mac OS temp files from recycle bin". If this setting is changed, files in the recycle bin may be corrupted.

Read-only Shares

By default, new shares are set with read & write access, but you may change the attribute to *Read Only* in *Attribute*. Read-only shares and HFS+ formatted USB hard drives will have "Read-only" added to the shared folder description.

Hidden Shares

If hidden shares is enabled, shared SMB folders will not be displayed in My Network, and only certain users are allowed to access them. To hide a shared SMB folder, follow the instructions below.

- 1** In Settings, navigate to *File Sharing - Folder Setup* and choose a shared folder or a USB drive to configure hidden shares.
- 2** Check "Hidden Share (SMB Only)" and click *OK*.

Note: If protocols other than "SMB" or "Backup" under "LAN Protocol Support" are enabled, the hidden shares option will be grayed out and cannot be selected.

To open a hidden folder, click *Start - Search programs and files* and enter "\\TeraStation name\Shared folder name\$" for the name. For example, if the TeraStation name is "TSXXX001" and the shared folder name is "share", enter "\\TSXXX001\share\$" to open it.

Adding Users

Note: The TeraStation can register a maximum 300 of users, which includes the default users "admin" and "guest".

- 1** In Settings, click *File Sharing*.

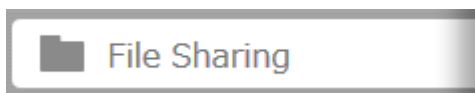

- 2** Click  to the right of "Users".



- 3** Click *Create User*.

4 Enter the desired settings, then click OK.

User Settings

* Required ?

Username: *

User ID:
Enter a number from 1000 to 1999.

Email:

Password: *

Confirm Password: *

Description:

Quota:

Enable (Units: GB)

Quota Alert: 1

Capacity:

Quota Capacity: 1

Disable

Filter: [] X

Group
<input type="checkbox"/> admin
<input checked="" type="checkbox"/> hdusers

Select All Unselect All

Primary Group:
hdusers

OK Cancel

Notes:

- Usernames may contain up to 128 characters, including hyphens (-), underscores (_), periods (.), !, #, &, @, \$, *, ^, and %. Do not use a symbol as the first character.
- The user ID should be a number from 1000 to 1999. Each user ID should be unique. If this field is left blank, a user ID is assigned automatically.
- Do not duplicate user IDs, group IDs, usernames, or group names. Each should be distinct and unique.
- The description may contain up to 75 alphanumeric characters, hyphens (-), underscores (_), and spaces. Do not use a symbol or space as the first character.
- Passwords may contain up to 20 alphanumeric characters and the following characters: - _ @ ! # \$ % & ' () * + , . / ; < > = ? " [] ^ { } | ~. Do not use a symbol other than an underscore (_) as the first character.
- Use the same username and password for both Windows and the TeraStation or you may not be able to access shared folders.
- Do not use any of the following words as a username: root, bin, daemon, sys, adm, tty, disk, lp, sync, shutdown, halt, operator, nobody, mail, news, uucp, ftp, kmem, utmp, shadow, users, nogroup, all, none, hdusers, admin, guest, man, www, sshd, administrator, ftpuser, apache, mysql

Importing User Information

You can import users in *File Sharing - Users* by clicking *Import CSV File*. Existing users will be overwritten.

Format for user data: Username (required), password (required), and user description (optional).

Examples:

username1,password1,comment1

username2,password2,comment2

username3,password3,comment3

Guidelines:

- Use commas (,) as separators. Do not put spaces before or after commas.
- If a line has an incorrect format, the user on that line will not be registered.
- If a username exists, the new user information will overwrite the old information.
- Do not use commas (,) in the username, password, or user description.

Note: Imported users are added to the "hdusers" group automatically.

Adding Groups

- 1** In Settings, click *File Sharing*.

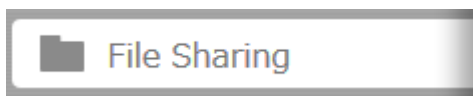

- 2** Click  to the right of "Groups".



- 3** Click *Add Group*.

4 Enter settings, then click OK.

Group Settings

Group Name: *Required ?

Group ID: (*Enter a number from 1000 to 1999.)

Group Privileges: General Users

Select a recipient for group notifications:

User (with email address configured)
Disabled

Email address

Description:

Quota:

Enable(Units: GB)
Quota Alert Capacity: 1
Quota Capacity: 1

Disable

Filter: X

Username

admin

Select All Unselect All

OK Cancel

Notes:

- Group names may contain up to 20 alphanumeric characters, hyphens (-), underscores (_), and periods (.). Do not use a symbol other than an underscore (_) as the first character.
- Group descriptions may contain up to 75 alphanumeric characters, hyphens (-), underscores (_), and spaces. Do not use a symbol or space as the first character.
- If the group ID field is left blank, a group ID is automatically assigned. Use numbers between 1000 and 1999 to set a group ID manually. Don't use duplicate group IDs.
- You may register up to 300 groups with the TeraStation.
- If you are logged in as a member of the general users group, you can only change your own password. If you're logged in as an administrator, you can change any settings, including other users' passwords. If you are logged in as a member of the power users group, you can create and edit shared folders, users, and groups.
- Do not use any of the following words as a group name: root, bin, daemon, sys, adm, tty, disk, lp, sync, shutdown, halt, operator, nobody, mail, news, uucp, ftp, kmem, utmp, shadow, users, nogroup, all, none, hdusers, admin, guest, man, www, sshd, administrator, ftpuser, apache, mysql

Configuring Access Restrictions

Local Users and Groups

- 1 In Settings, click *File Sharing*.

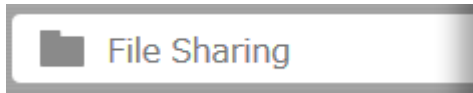

- 2 Click  to the right of "Folder Setup".



- 3 Click the shared folder that you want to set access restrictions for.

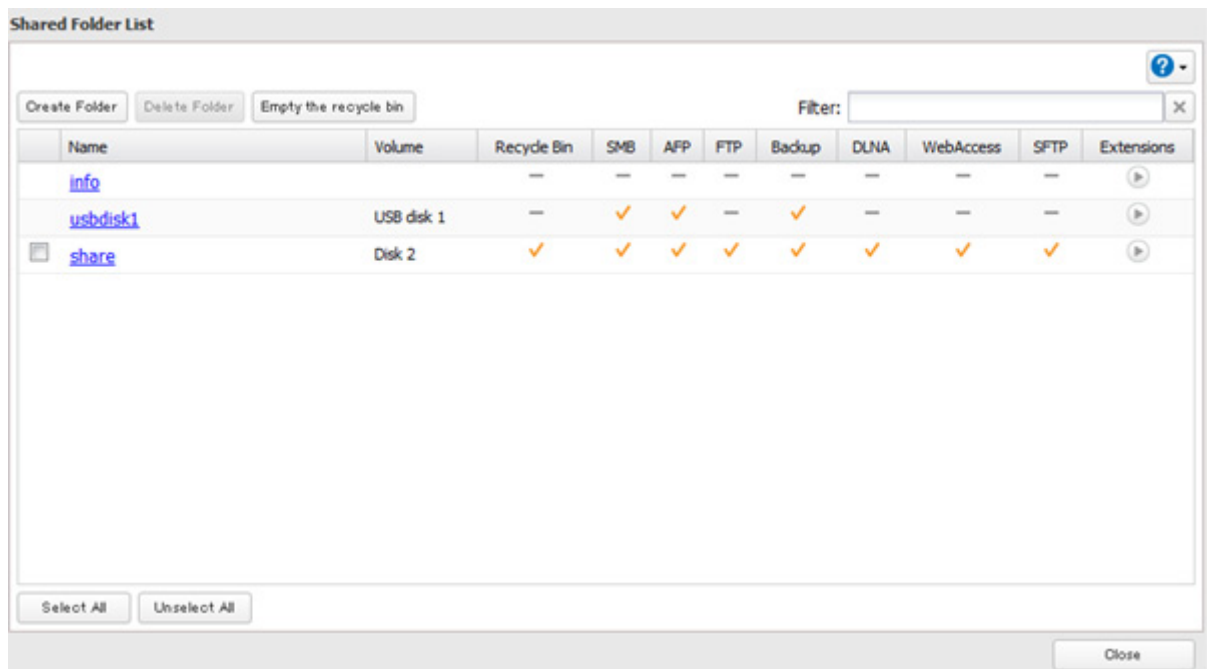

- 4 Click *Edit*.

- 5 Enable "Access Restrictions".



- 6 Select the level of access for the user or group you added.

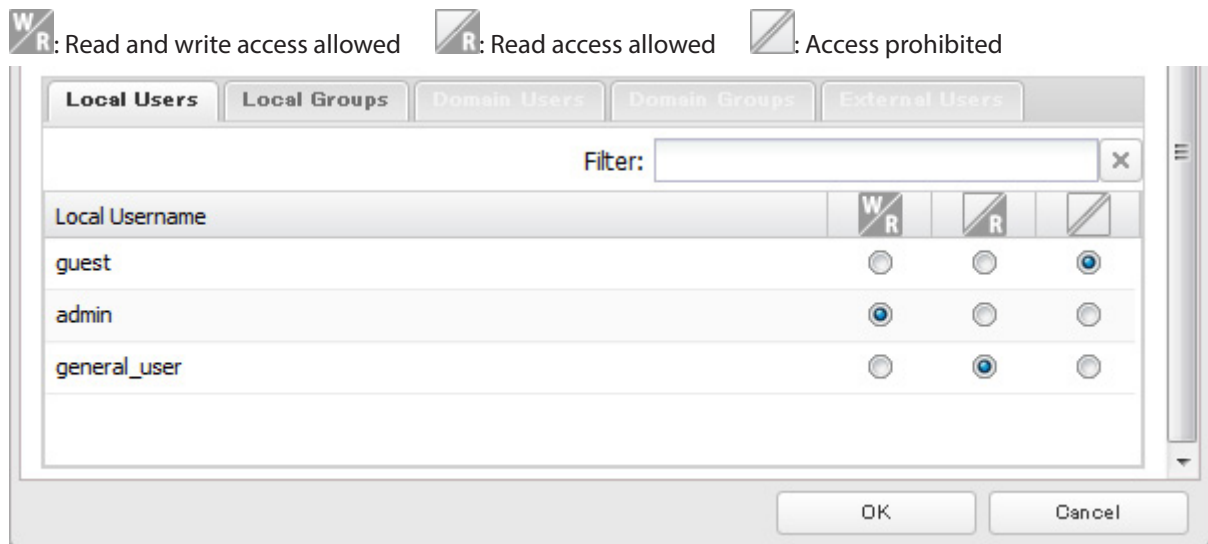

7 Click *OK*.

Notes:

- The example above shows access restriction by user. To restrict access by group, click the *Local Groups* tab and select group permissions.
- If both read-only and read & write permissions are given to a user, the user will have read-only access. The most restrictive access always applies.

Active Directory

The TeraStation can join an Active Directory domain. Up to 1000 domain users and 1000 groups may be downloaded from Active Directory.

Notes:

- The TeraStation supports a domain environment with a maximum of 1000 users and 1000 groups. 10,000 users and 10,000 groups can be downloaded from the domain controller but are not supported.
- If usernames or group names from Active Directory include multi-byte characters, you will not be able to configure access restrictions for them.

1 In Settings, click *Network*.

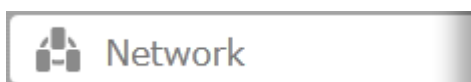

2 Click  to the right of "Workgroup/Domain".



3 Click *Edit*.

- 4 Select "Active Directory", then click *Next*.

Workgroup/Domain Settings

Authentication Method

Workgroup

NT Domain

Active Directory

Next Cancel

- 5 Click *Yes*.

- 6 Enter the desired settings, then click *OK*.

Active Directory Domain Settings

* Required

NetBIOS Name * : WORKGROUP

DNS Name * :

Active Directory Domain Controller Name * :
(Authentication Server)



Administrator Name * :

Administrator Password * :

WINS Server IP Address:

OK Cancel

- 7 Click  to the right of "Folder Setup".

 Folder Setup 4 Folder(s) 

8 Click a shared folder that you want to set access restrictions for.

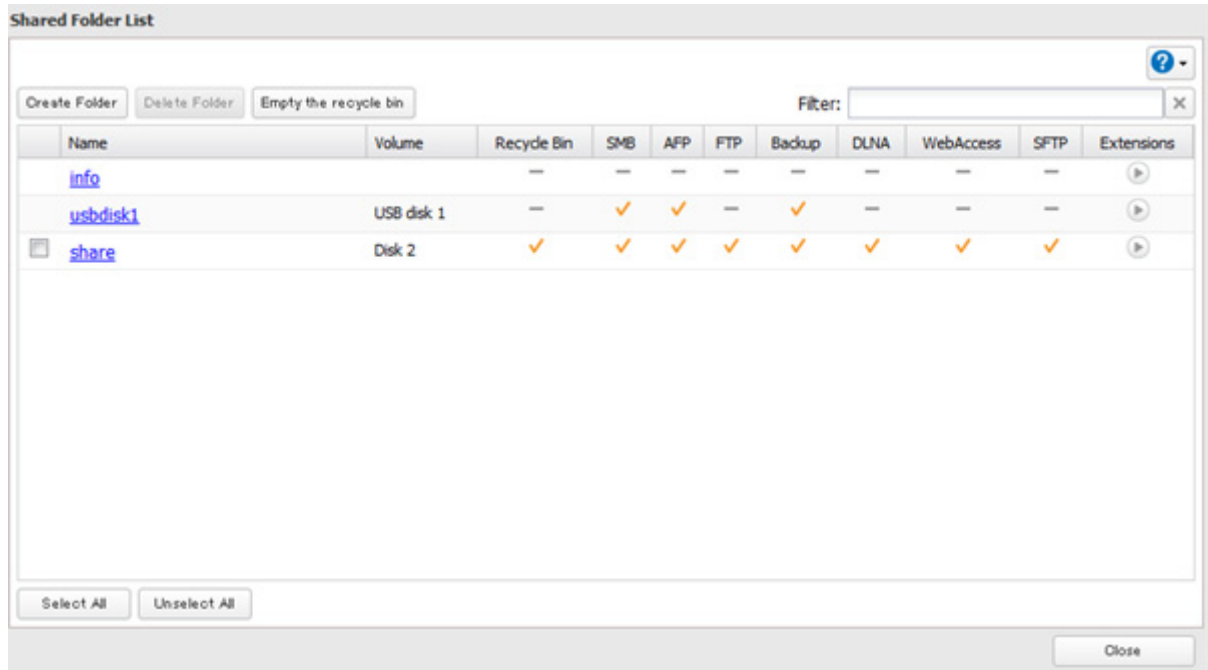

9 Click *Edit*.

10 Enable "Access Restrictions".



11 Select the level of access for the user or group.



12 Click *OK*.

Notes:

- To have the TeraStation join an Active Directory domain, configure it to use a DNS server that can resolve names for the Active Directory domain.
- After building an Active Directory domain, the administrator password for joining the domain must be changed at least once, or joining the Active Directory domain will fail.
- The DNS name and NetBIOS name of Active Directory domains should be identical.
- If both read-only and read & write permissions are given, the user will have read-only access. The most restrictive access setting will apply.
- If there are more than 5 minutes difference between the TeraStation's clock and the domain controller's clock, joining the domain or authenticating domain users and groups may fail. For best results, use an NTP server to set the time for all network devices.
- To use the TeraStation as a member server in an Active Directory domain, the TeraStation should be logged in to the domain and accessed from a computer that is not a member of the domain with a valid domain account.
- If the TeraStation is a member server of an Active Directory domain, you cannot connect as a guest user via AFP.
- If your TeraStation is a member server in an Active Directory domain and you change the authentication method to "Workgroup", the account on the domain controller will not be deleted automatically.
- If FTP is enabled, local domain group access restrictions from the AD network do not work. Use user access restrictions instead.

- Don't disable the SMB protocol while Active Directory is used for access restrictions. If you do, you will need to enable SMB again and reconfigure AD from scratch.

NT Domain

In an NT domain environment, the TeraStation uses account information from the NT domain server to set access restrictions for files and folders on the TeraStation. There's no need to perform individual account management for the TeraStation. If multiple TeraStations are installed on the network, the account information is centrally managed in the NT domain, greatly reducing the operations required for installation and management.

Note: A maximum of 1000 domain users and 1000 groups can be downloaded from an NT domain server. 10,000 users and 10,000 groups can be downloaded from the domain controller but are not supported.

1 Create an account on the domain controller for the TeraStation.

2 In Settings, click *Network*.

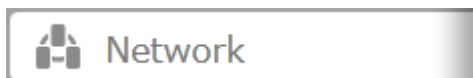

3 Click  to the right of "Workgroup/Domain".

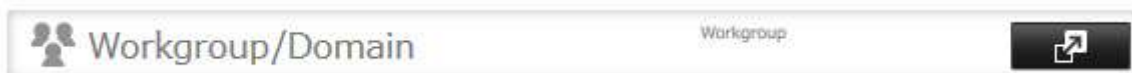

4 Click *Edit*.

5 Select "NT Domain", then click *Next*.

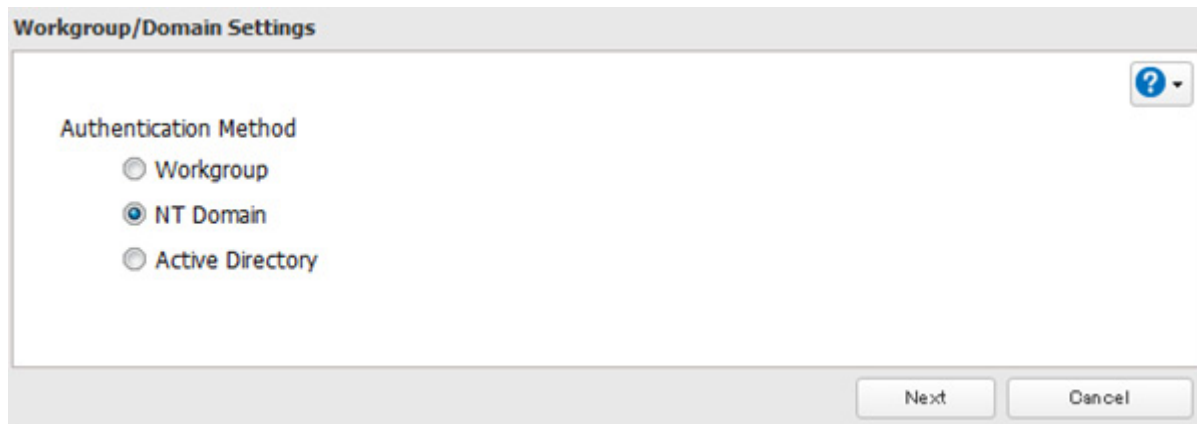

Note: To use Active Directory from Windows 2000 or Windows Server 2003, select "Active Directory" instead of "NT Domain".

6 Click *Yes*.

7 Enter settings and click OK.

NT Domain Settings

* Required ?

NT Domain Name * : WORKGROUP
(NetBIOS Name)

NT Domain Controller Name * :
(Computer Name)

Administrator Name * :
Administrator Password * :

WINS Server IP Address:

OK Cancel

8 Click  to the right of "Folder Setup".

Folder Setup 4 Folder(s)

9 Click a shared folder for which you want to set access restrictions.

Shared Folder List

Create Folder Delete Folder Empty the recycle bin Filter: X

Name	Volume	Recycle Bin	SMB	AFP	FTP	Backup	DLNA	WebAccess	SFTP	Extensions
info		—	—	—	—	—	—	—	—	▶
usbdisk1	USB disk 1	—	✓	✓	—	✓	—	—	—	▶
<input checked="" type="checkbox"/> share	Disk 2	✓	✓	✓	✓	✓	✓	✓	✓	▶

Select All Unselect All Close

10 Click *Edit*.

11 Enable "Access Restrictions".

Access Restrictions: Enable Disable

12 Select the level of access for "Domain Users" or "Domain Groups" you added.

: Read and write access allowed : Read access allowed : Access prohibited

13 Click OK.

Notes:

- If you change the TeraStation's name, you will no longer be able to use domain users and groups or access restrictions. To repair this, rejoin the domain.
- If both read-only and read & write permissions are given to a user, the user will have read-only access.
- If a domain username is more than 20 bytes long, the TeraStation truncates it to 20 bytes.
- To use the TeraStation as a member server in an NT domain, the TeraStation should be logged in to the domain and accessed from a computer that is not a member of the domain with a valid domain account.
- If the TeraStation is a member server of an NT domain, you cannot connect as a guest user via AFP.
- When you change the user or group settings on the domain controller, these changes may not take effect immediately on the TeraStation until it is rebooted.
- If your TeraStation is a member server in an NT domain and you change the authentication method to "Workgroup", the account on the domain controller will not be deleted automatically.
- If FTP is enabled, local and domain group access restrictions from the NT domain network do not work. Use user access restrictions instead.
- Don't disable the SMB protocol while an NT domain server is used for access restrictions. If you do, you will need to enable SMB again and reconfigure the NT domain settings from scratch.

User Authentication with an External SMB Server

TeraStations on your network can be linked to an external authentication server for centralized management of user accounts and passwords. The authentication server should be another TeraStation or a LinkStation. Other external SMB authentication servers are not supported.

Notes:

- Disable SMB2 before using external authentication.
- Access restrictions for local users and groups will still apply to shared folders if an external SMB server is used for authentication.
- The procedure below contains methods to automatically register external users. You can also manually add external users by converting them from local users. Refer to the "Converting Local Users into External Users" section below for more details on converting local users.

1 In Settings, click *Network*.

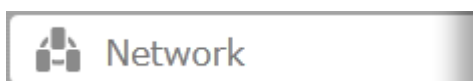

2 Click  to the right of "Workgroup/Domain".



3 Click *Edit*.

- 4 Select "Workgroup" and click *Next*.

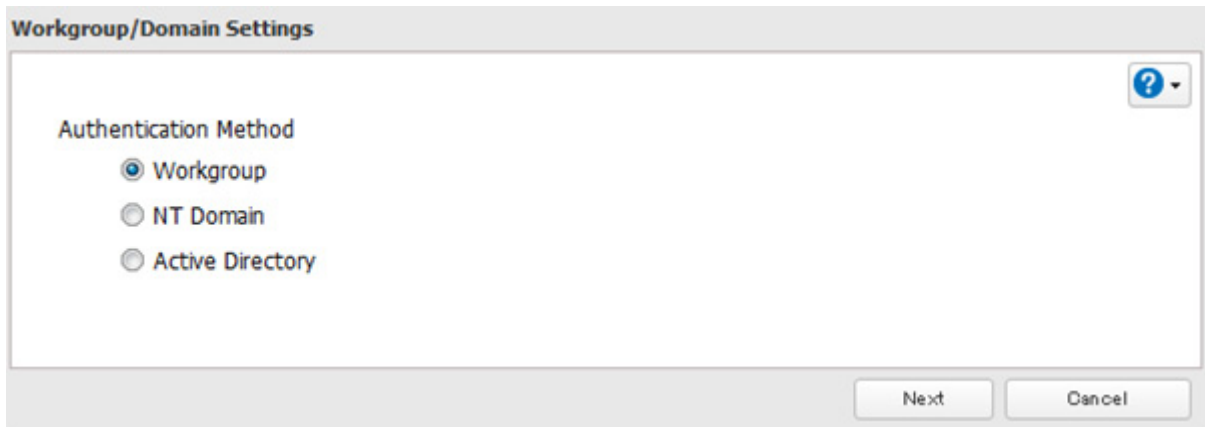

- 5 If a prompt appears, click *Yes*.

- 6 Enter a workgroup name. Select "Assign authorization to external SMB server" and enter the SMB server's IP address. You can also specify a server from another subnet.

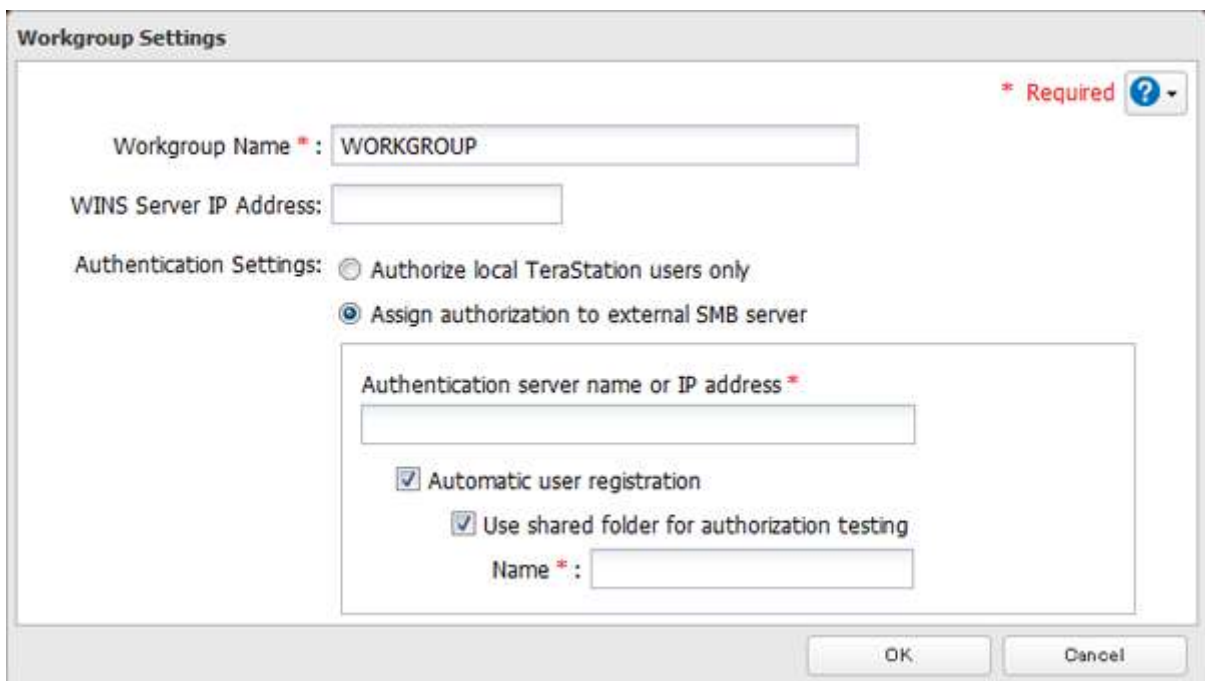

- 7 If "Automatic user registration" is checked, users that access any of the TeraStation's folders will be automatically registered as external users. This process only applies with folders that have access restrictions disabled. After new external users are added, disable this option to limit the number of authenticated user accounts.

- 8 If "Use shared folder for authorization testing" is checked, the TeraStation will automatically create a read-only shared folder. Enter the shared folder name. Users that access this specific folder will be automatically registered as external users. If this setting is de-selected at a later time, the TeraStation will automatically remove the folder.

Note: Connect to the authentication folder via SMB, not FTP or AFP. Automatic user registration may not work with OS X 10.8 (or later) the first time. If this occurs, try rebooting the TeraStation then access the authentication shared folder again.

- 9 Click *OK* to save any changes. When saving changes to the external authentication server settings, you may not to convert all current local users to external users. If a local user is converted to an external user, their user

information (including passwords) will be removed from the NAS. External users cannot be reverted to local users.

10 Click  to the right of "Folder Setup".



11 Click a shared folder to set access restrictions on.

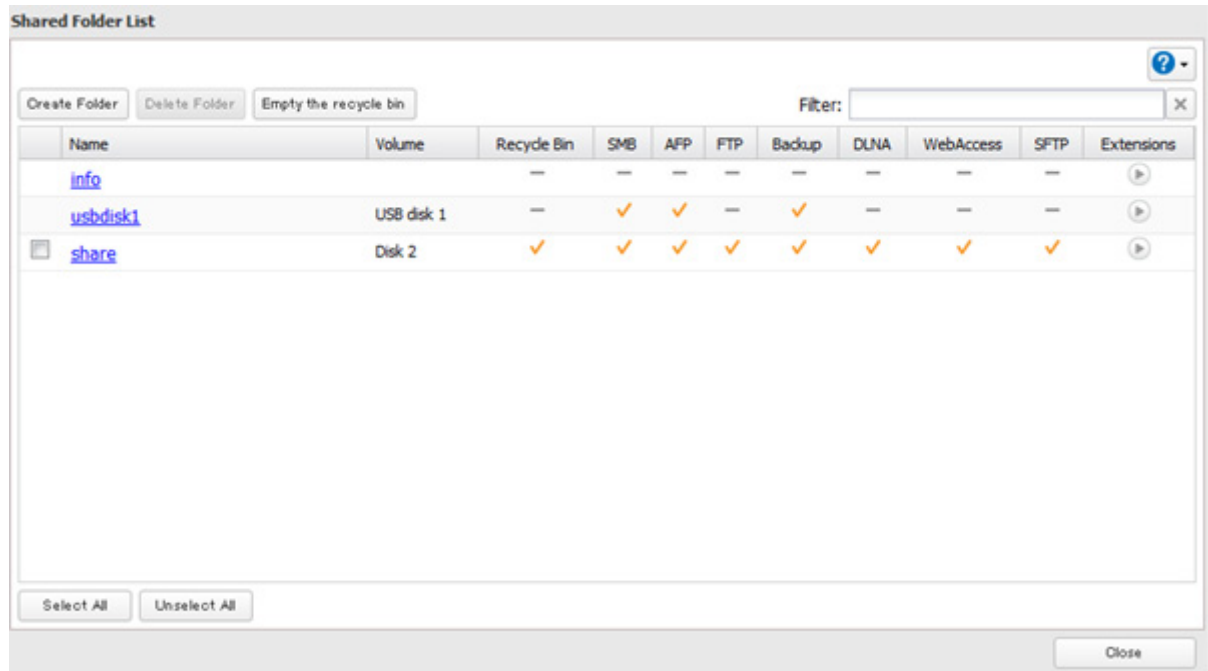

12 Click *Edit*.

13 Enable "Access Restrictions".



14 Click on the *External Users* tab and select the level of access for each external user.



15 Click *OK*.

Notes:

- Users that are automatically registered belong to the "hdusers" group. They can be added to other groups from within group settings. Added users will be listed in "Users" - "External Users". To delete a user that was registered automatically, select that user and click *Delete External User*.
- If both read-only and read & write permissions are given to a user, the user will have read-only access.
- OS X 10.4 or earlier and Windows Server 2012 are not supported with external authentication.
- To access access-limited shared folders from OS X 10.7, use AFP instead of SMB; under "LAN Protocol Support", check "AFP (Mac)" on the destination folders to use AFP and click *OK*.
- If access restrictions are set for users and groups from the authentication server, guest and anonymous connections will not be possible with AFP connections.
- FTP connections do not support authentication with an external SMB server.

- If using a Windows PC for external authentication, the default Windows SMB security settings may need to be changed. An easy way to do this is to run the File Sharing Security Level Change Tool, available from this product's download page on the Buffalo website. This utility will let you easily change or restore your Windows security settings to work with external authentication.

Converting Local Users into External Users

If using an external SMB server for authentication, you may convert any local users into external users. This way, the TeraStation will have a user list that matches the users in the external SMB server, and access restrictions for this TeraStation's shared folders may be assigned to the converted "external" users.

Follow the steps below to convert a local user into an external user. If a local user is converted, their user information (including passwords) will be removed from the TeraStation. External users cannot be reverted to local users.

Note: External authentication should be enabled before local users can be converted. For more information on external authentication, refer to the "User Authentication with an External SMB Server" section.

- 1** In Settings, click *File Sharing*.
- 2** Click  to the right of "Users".
- 3** In the user list screen, check any users to be converted to an external user, then click *Convert to External User*.
- 4** Enter the confirmation number and click *OK*.

Converted users are displayed under the "External Users" tab. You can then configure access restrictions for external users.

Chapter 4 Managing Storage

RAID Arrays

TeraStations support many types of RAID. The type of RAID arrays available for use depends on how many drives are installed in your TeraStation.

TeraStation	Default RAID Mode
TS5800D, TS5800DN, TS5800DWR TS5600D, TS5600DN TS5400D, TS5400DN, TS5400DWR TS5400R, TS5400RH, TS5400RN, TS5400RWR	RAID 5
TS5200D, TS5200DN, TS5200DS, TS5200DWR	RAID 1

Notes:

- If you change the RAID mode, all data on the array is deleted. This is true for every procedure in this chapter. Always back up any important data before performing actions that affect your RAID array.
- Hard drive capacity is shown in Settings in actual gigabytes. The Properties window in Windows may show GiB instead, which will be a smaller number.
- After the RAID mode is changed (except when creating a RAID 0 array or JBOD), the TeraStation performs a RAID check that will take about 10 hours per TB. File transfers are slower during this period. While the I17 message is displayed on the LCD panel, do not turn off the TeraStation. If you do, the RAID check starts over.
- If the TeraStation is restarted or shut down while changing the RAID mode, the message displayed on the LCD panel will change from I46 or I47 to I18.

RAID 6*

RAID 6 arrays are available for TeraStations with 4 or more hard drives. RAID 6 combines 4 or more drives into a single array. The usable space is equal to the sum of the capacity of all drives minus the capacity of two drives. For example, if 4 drives are combined into a RAID 6 array, the usable space is the sum of the capacity of 2 drives. If 2 drives in the array are damaged, you can recover data by replacing them. If 3 or more drives are damaged, your data is lost.

RAID 61***

RAID 61 arrays are available for TeraStations with 8 or more drives. In this mode, two RAID 6 arrays are mirrored in a RAID 1 array. 8 drives in a RAID 61 array have a usable capacity of 2 x the capacity of the smallest drive.

RAID 60***

RAID 60 arrays are available for TeraStations with 8 or more drives. In this mode, two RAID 6 arrays are combined in a RAID 0 array. 8 drives in a RAID 60 array will have a usable capacity of 4 x the capacity of the smallest drive.

RAID 5*

RAID 5 arrays are available for TeraStations with 3 or more hard drives. RAID 5 combines 3 or more drives into a single array. The usable space is equal to the sum of the capacity of the hard drives minus the capacity of one drive. For example, if 4 drives are combined into a RAID 5 array, the usable space is the sum of 3 drives. If one drive in the array is damaged, you can recover data by replacing the damaged drive. If two or more drives are damaged at the same time, your data is lost.

RAID 51**

RAID 51 arrays are available for TeraStations with 6 or more hard drives. In this mode, two RAID 5 arrays are combined into a RAID 1 array. The total usable space for 6 drives in a RAID 51 array is 2 x the capacity of the smallest drive. For 8 drives, the total usable capacity is 3 x the capacity of the smallest drive.

RAID 50**

RAID 50 arrays are available for TeraStations with 6 or more hard drives. In this mode, two RAID 5 arrays are combined into a RAID 0 array. The total usable space for 6 drives in a RAID 50 array is equal to 4 x the capacity of the smallest drive. For 8 drives, the total usable space is equal to 6 x the capacity of the smallest drive.

RAID 10*

RAID 10 arrays are available for TeraStations with 4 or more hard drives. In this mode, mirrored pairs of drives in RAID 1 arrays are combined into a RAID 0 array. The usable space is equal to the capacity of the smallest drive multiplied by the number of hard drives divided by 2.

RAID 1

Combines 2 or more drives into a mirrored array. The available space in the array is the capacity of a single drive. Identical data is written to each drive. If a drive is damaged, data can be recovered by replacing the damaged drive. As long as one drive in the array remains undamaged, all data in the array can be recovered.

RAID 0

Combines 2 or more hard drives into a single array. The usable disk space is the total space of all drives used. This simple RAID mode offers faster performance than RAID modes that include parity. If a single drive in the array fails, then all data in the array is lost.

JBOD

This mode uses the hard drives inside the TeraStation as individual drives. The disk space you can use is the total capacity of all drives in the TeraStation. If any drive is damaged, then the data on that drive is lost.

*Available for 8-drive, 6-drive, 4-drive models.

**Available for 8-drive and 6-drive models.

***Available for 8-drive models only.

Working with RAID Arrays

To change RAID settings, navigate to *Drives - RAID* in Settings.

Using JBOD

With JBOD, each hard drive in the TeraStation is addressed separately. To put drives from an array into JBOD, follow the steps below.

- 1 In Settings, click *Drives*.



- 2 Click  to the right of "RAID".

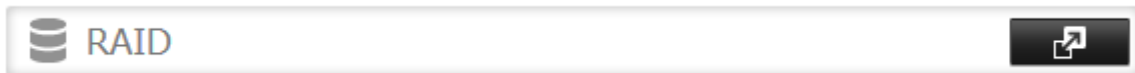

- 3 Click the array to delete.

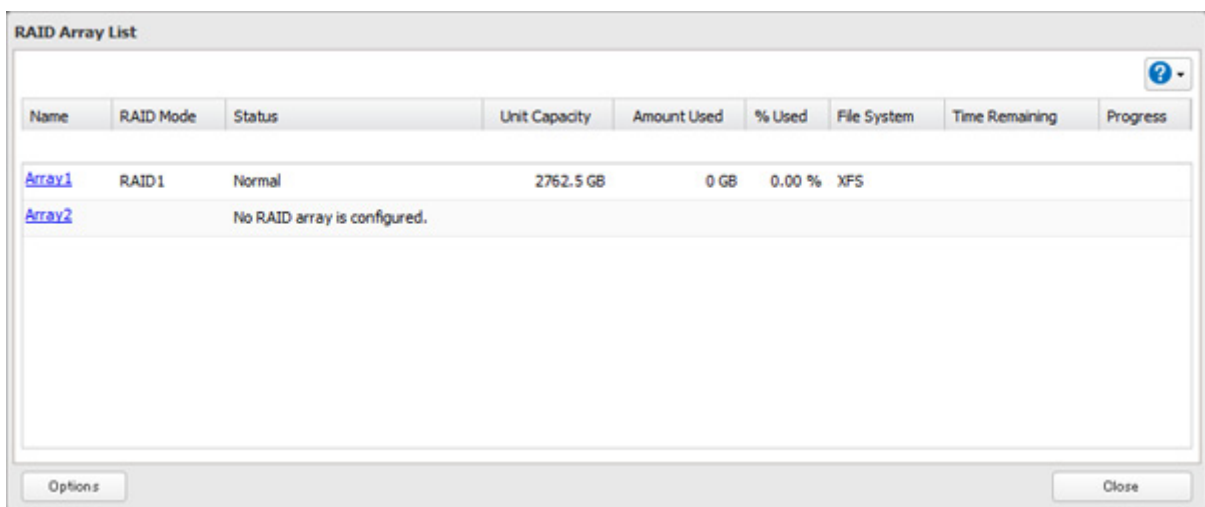

- 4 Click *Delete RAID Array*.

Once JBOD is configured, create shared folders on each drive to use them.

Changing RAID Mode

To change the RAID mode, first put the drives in JBOD.

- 1 In Settings, click *Drives*.

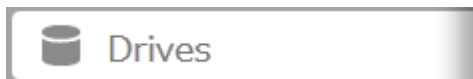

- 2 Click  to the right of "RAID".



3 Click the array to delete.

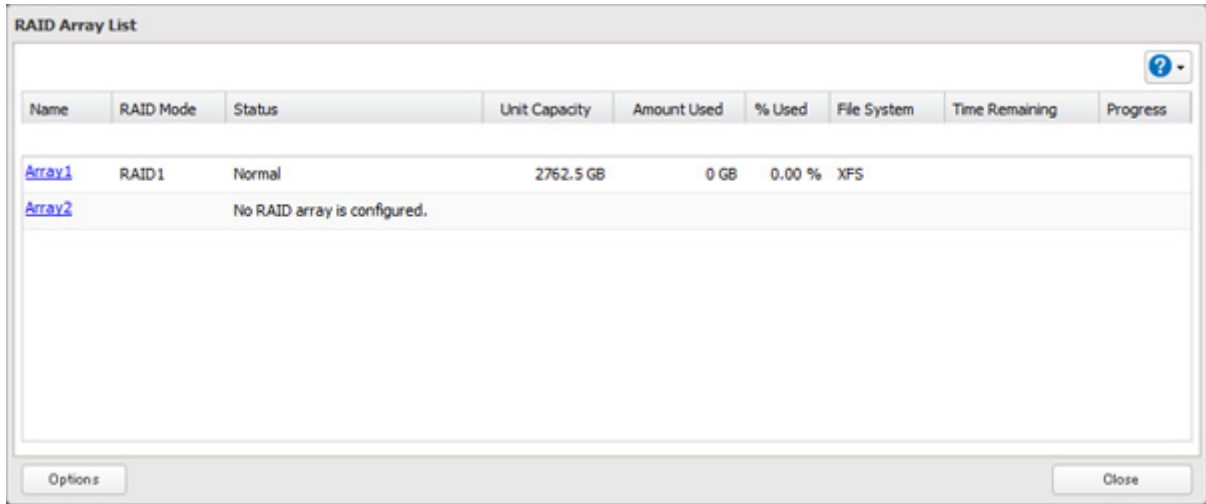

Note: If the "RAID Mode" field is blank, the array is already in JBOD. Proceed to step 7.

4 Click *Delete RAID Array*.

5 The "Confirm Operation" screen will open. Enter the confirmation number, then click *OK*.

6 Click *OK*.

7 Choose a RAID array.

8 Select a RAID mode and the drives to be used, then click *Create RAID Array*.

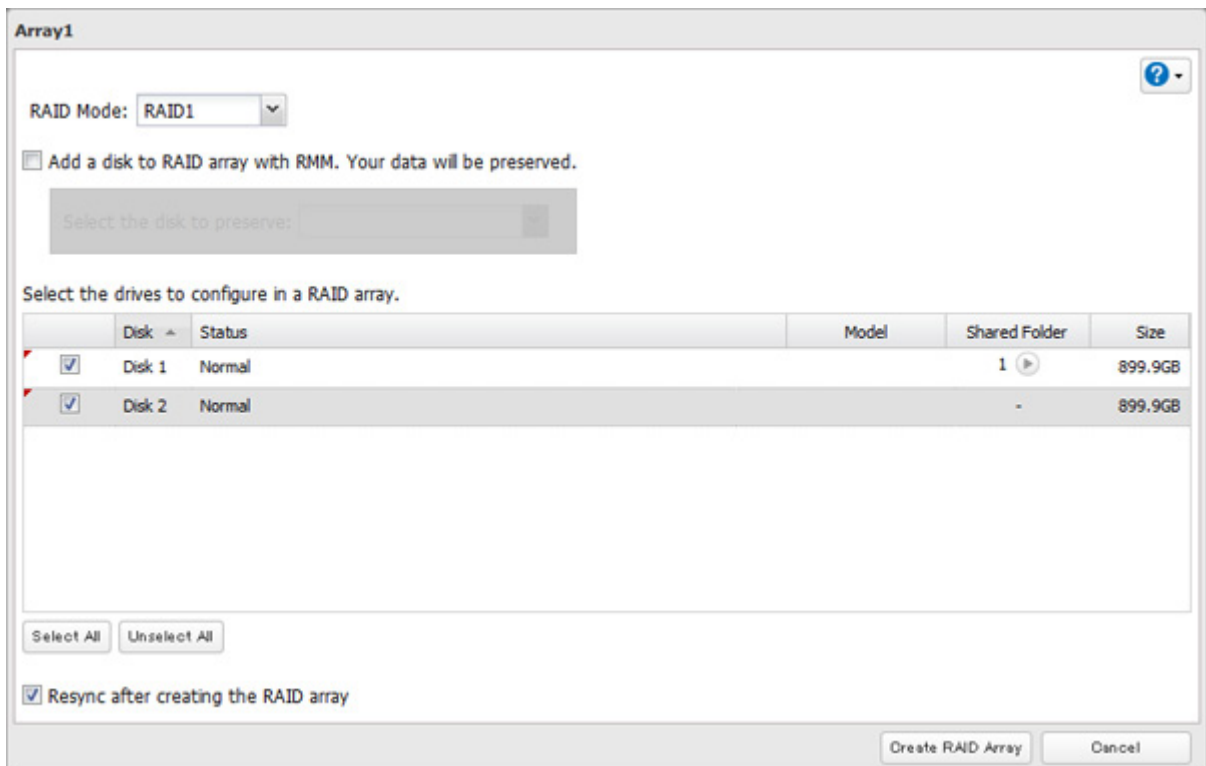

Note: Normally, after a RAID array is created, it is "resynced", which optimizes the array, making it more stable. The resyncing process takes about 1 hour per terabyte of space in the array. File transfers will be slower during this period, but the array will remain fully usable. The I17 message will be shown on the LCD display during the resync. If you uncheck "Resync after creating the RAID array", the resync will be skipped. This is not recommended for RAID 5 arrays, which should always be resynced. Resyncing is not needed for RAID 0 arrays. If the TeraStation is rebooted during the resyncing process, the resync will begin again from the beginning.

9 Step through the wizard to create the array.

Notes:

- You can also configure RAID settings from Easy Admin.
- After changing the RAID mode, create a shared folder.

Configuring a Hot Spare

If you have a hot spare configured and an array fails, the TeraStation immediately switches over to the hot spare. To use a hot spare, you need an extra drive that's not part of any array and a RAID 1, RAID 10, RAID 5, RAID 51, or RAID 6 array.

Notes:

- All data on the hot spare drive is deleted when it is configured as a hot spare and again when it changes from a spare to a drive in the array.
- A hot spare cannot be configured for TeraStation models with only two hard drives. Use RAID 1 instead.

1 In Settings, click *Drives*.



2 Click  to the right of "RAID".



3 Choose a RAID array.

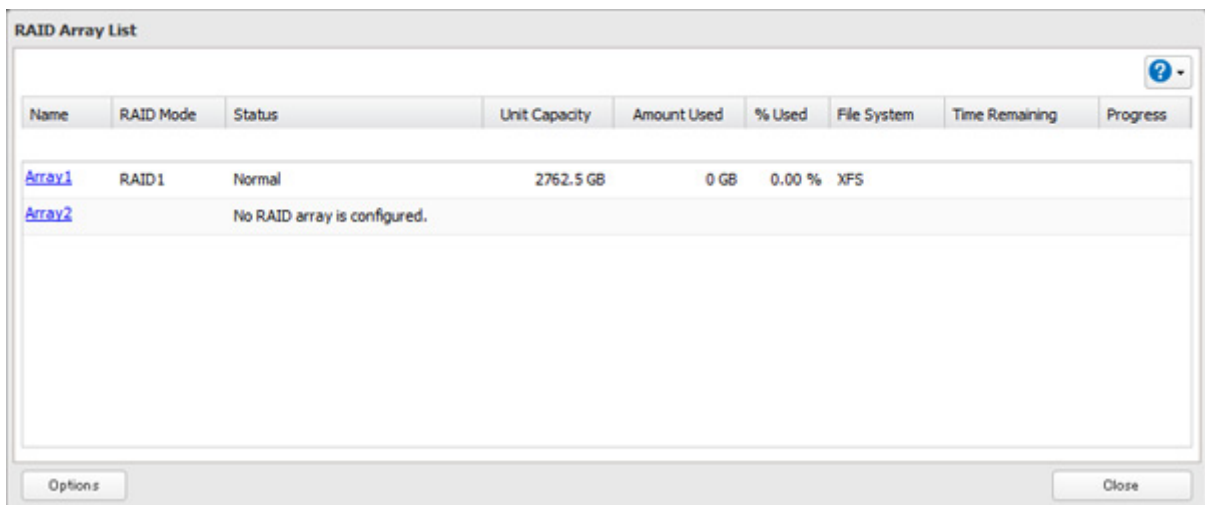

4 Click *Set as a hot spare*.

5 Step through the wizard.

6 When the "Confirm Operation" screen opens, enter the confirmation number and click *OK*.

Notes:

- To turn the hot spare back into a normal disk, choose *Set as a normal disk*.
- If a drive fails in the RAID array before it is rebooted, the hot spare will not automatically replace the failed drive. In this case, follow the steps below to repair the array.
 - (1) In Settings, navigate to *Drives - Drives*.
 - (2) Click the drive that was configured as a hot spare, then click *Dismount Disk*.

- (3) Click *Rediscover Disk*.
- (4) Navigate to *Drives - RAID*.
- (5) Choose the RAID array to repair.
- (6) Click the drive that was previously configured as a hot spare, then click "Recover RAID Array".
This will rebuild the RAID array.

RMM (RAID Mode Manager)

With RMM, you can create or expand a RAID array without erasing the data on the drives.

Changing from JBOD to RAID 1

Hard drives that aren't in a RAID array show "Normal". You must have at least two drives available in JBOD (not in a RAID array) to build the RAID 1 array with RMM.

- 1 In Settings, click *Drives*.



- 2 Click  to the right of "RAID".



- 3 Choose a RAID array.

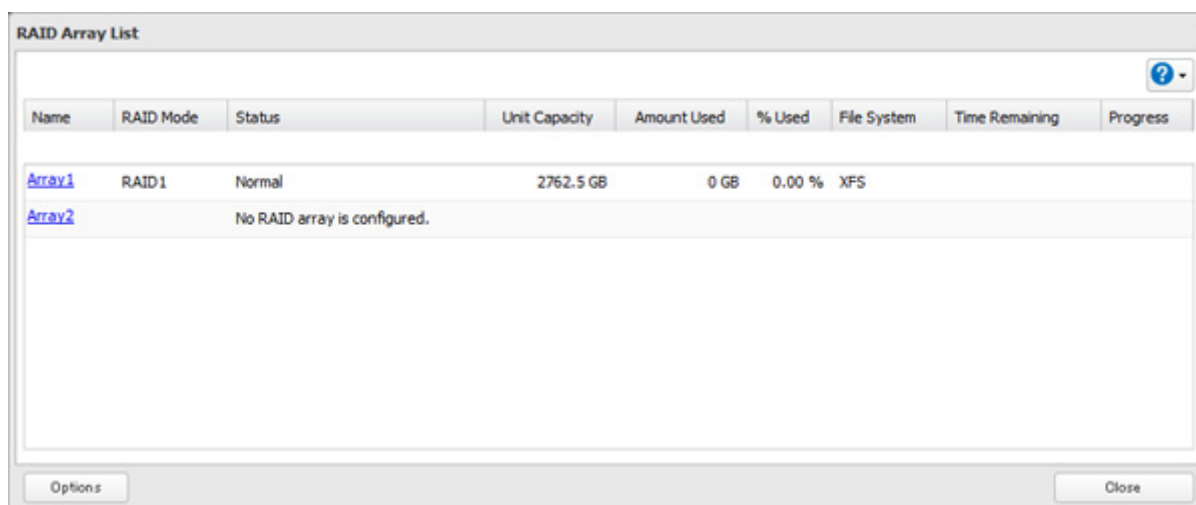

- 4 Set the RAID mode to "RAID 1".

- 5** Check "Add a disk to RAID array with RMM. Your data will be preserved."

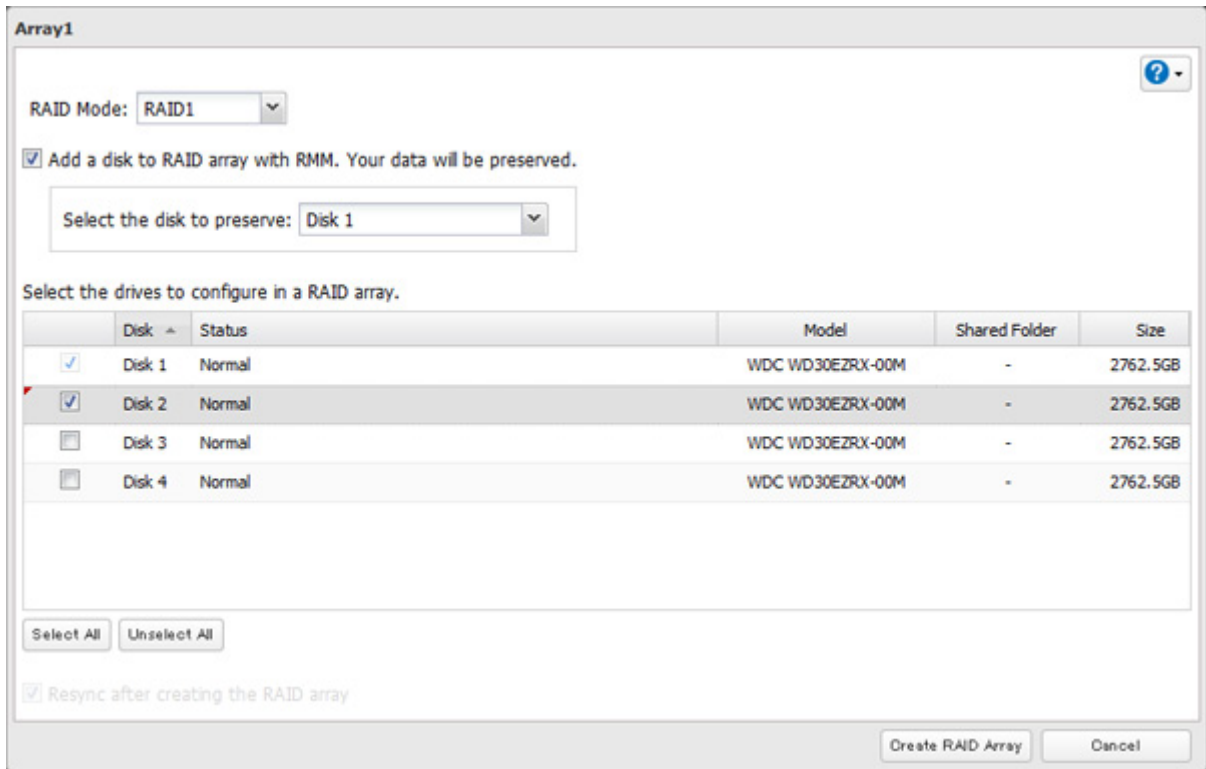

- 6** Select the drive whose data will be saved from the drop-down menu.
- 7** Select the drive to add to the RAID array.
- 8** Click *Create RAID Array*.
- 9** The "Confirm Operation" screen will open. Enter the confirmation number, then click *OK*.

Adding a Drive to an Existing RAID Array

You can add a drive to a RAID 1, RAID 5, or RAID 6 array. Drives that can be added to the RAID array show "Normal".

Note: RMM can be used to expand an array by one drive per operation. To expand by two or more drives, RMM must be performed multiple times.

- 1** Click *Drives*.

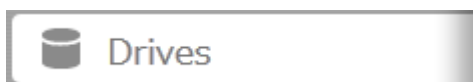

- 2** Click  to the right of "RAID".

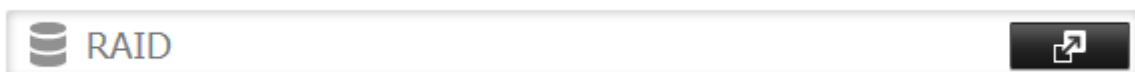

3 Choose a RAID array.

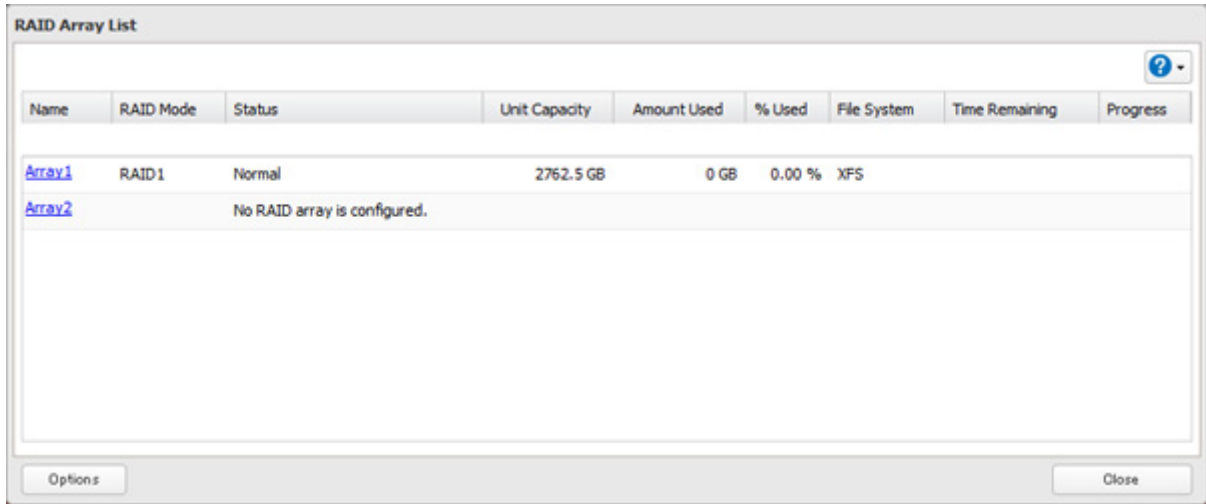

4 Select the drive to add to the RAID array.

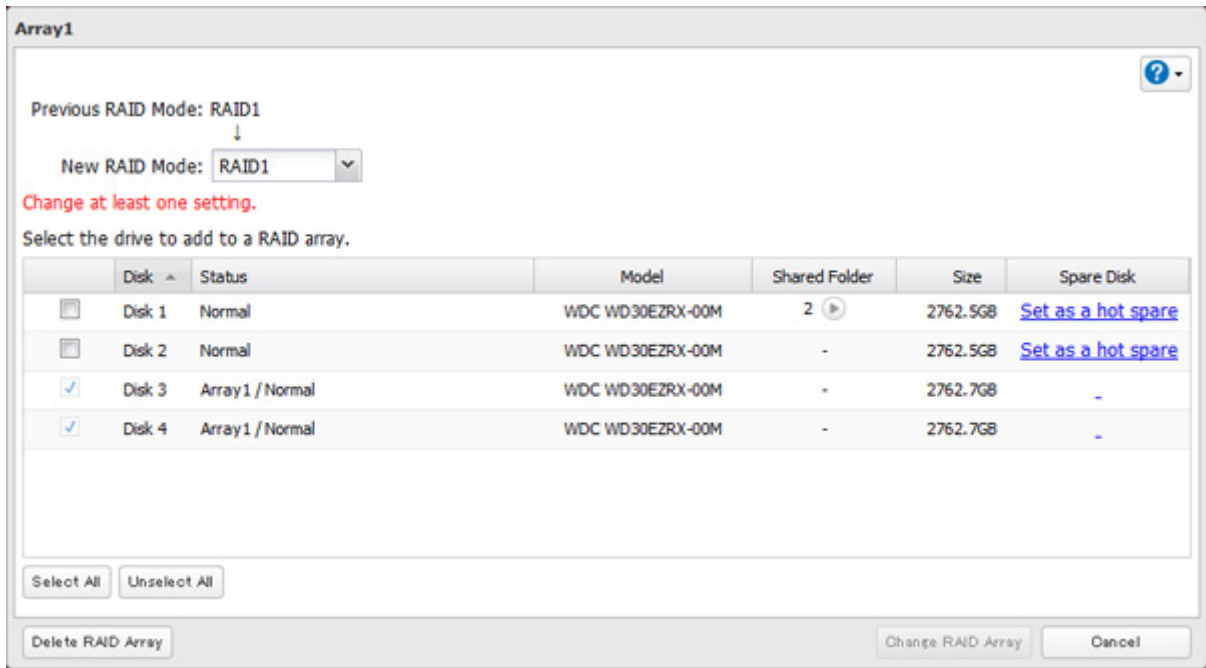

5 Click *Create RAID Array*.

6 The "Confirm Operation" screen will open. Enter the confirmation number, then click *OK*.

Changing the RAID Mode While Adding a Drive

Select the drive you want to add to the RAID array and choose the mode for the array. Enter the "Confirm Operation" number and click *OK*.

RAID Scanning

RAID maintenance scans your RAID array for bad sectors and if it finds any it automatically repairs them. RAID 1, RAID 10, RAID 5, and RAID 6 arrays are supported. For best results, run RAID maintenance regularly.

1 In Settings, click *Drives*.



2 Move the RAID scanning switch to the  position to enable RAID scanning.

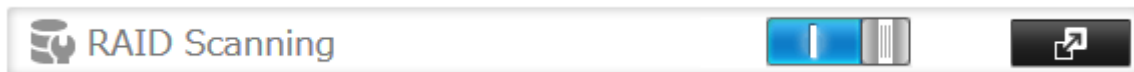

3 Click  to the right of "RAID Scanning".



4 Click *Edit*.

5 Select when to run the scan and click *OK*.

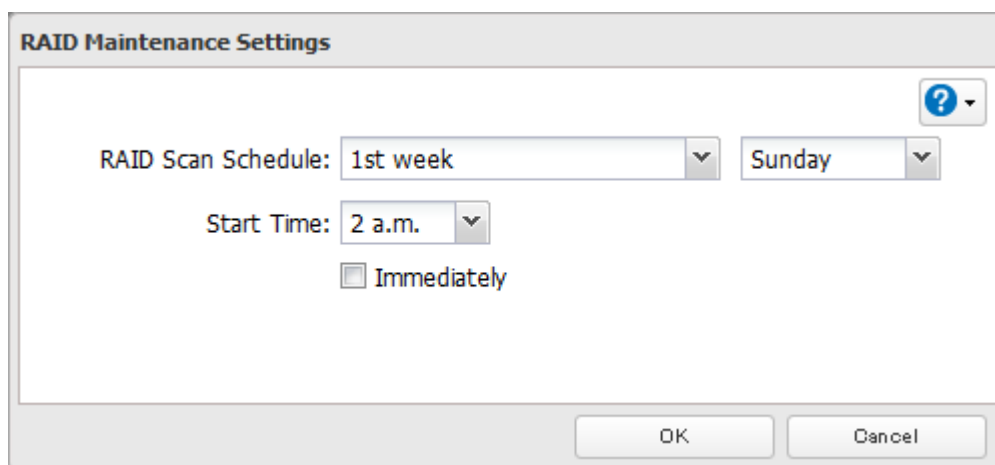

Notes:

- Check "Immediately" to run RAID maintenance immediately.
- To stop a RAID scan, click *Cancel RAID Scan*.

Adding an External Hard Drive

Connecting an External Drive

Your TeraStation includes USB ports (the number of ports depends on your model), and you can connect external drives to these ports. Once connected they appear as shared folders on the TeraStation. Formatted drives are detected automatically. Unformatted drives should be formatted in Settings.

After a USB drive is recognized, Windows adds "usbdisk X" under the TeraStation in "Network", where "X" is the USB port where the hard drive is connected.

Compatibility

The following USB devices are supported by the TeraStation:

- USB storage devices
- Card readers (except for card readers that can recognize two or more memory cards)

Buffalo external USB drives are recommended. However, the following USB drives are not supported:

- DUB and DIU series drives

Supported file systems for external drives are below:

- FAT32
- EXT3
- XFS
- NTFS
- HFS+ (read-only)

Connect only one device to each USB port of the TeraStation. Some external drives with automatic power-on don't turn on automatically when connected to the TeraStation. Use their manual power switch to turn them on. Be sure to connect only one bus-powered drive at a time. If there is insufficient bus power for your USB drive, connect its AC adapter. Note that only the first partition of a connected USB hard drive is mounted. Additional partitions are not recognized. Do not connect bus-powered devices to the 2-drive TeraStation models.

Notes:

- Backup data from Mac OS may include characters that cannot be written to FAT16 or FAT32 drives such as ".DS_Store". For best results, reformat the drive before using it as a backup target.
- If your USB 3.0 hard drive is not reconfigured after rebooting the TeraStation, unplug and reconnect it.

Dismounting Drives

If the TeraStation is powered on, dismount drives (internal and external) before unplugging them. You may dismount external drives with the function button, or any drive from Settings. If the TeraStation is off, then all drives are already dismounted and may be unplugged safely.

Note: Do not dismount internal drives while a RAID array is rebuilding or RMM is being configured. If you do, data on the drives may be lost.

Dismounting with the Function Button

Hold down the function button for 8 seconds. The function button will light up blue for 30 seconds as your USB drives are dismounted. When the dismount is finished, the function button's LED will turn off, then come back on. You may now unplug any USB drives safely.

Note: After 60 seconds, the function LED will go out and any drives that have not yet been unplugged will be remounted.

Dismounting from Settings

- 1 In Settings, click *Drives*.



- 2 Click *Drives* to dismount an internal drive or *USB Drives* to dismount an external drive.



- 3** Select the drive to dismount and click *Dismount Disk*.

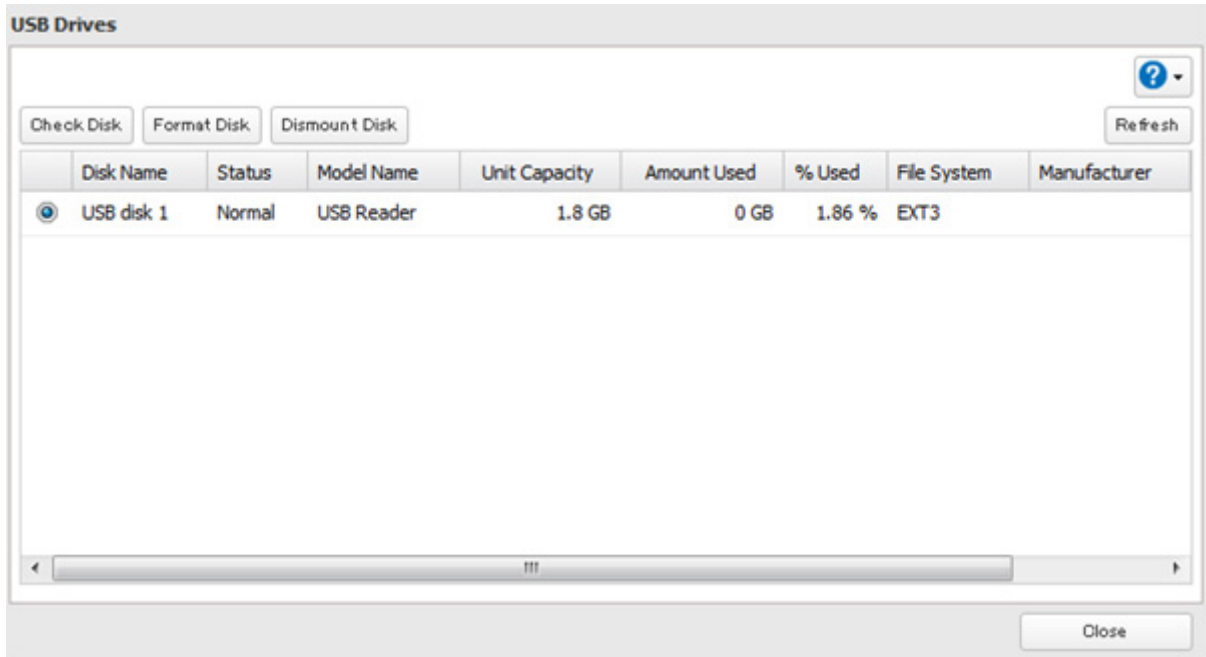

- 4** When the following message is displayed, it is safe to unplug the drive.

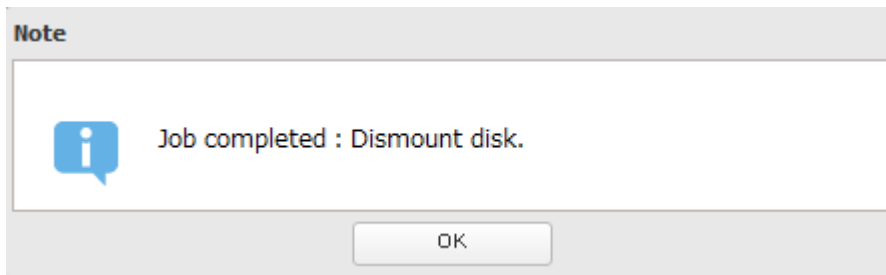

Note: To remount the drive, unplug it and then plug it back in.

Checking Drives

A disk check tests the data on a drive in the TeraStation or connected via USB for integrity. Errors are fixed automatically. With large drives, a disk check may run for many hours. Shared folders cannot be accessed during a disk check. Do not turn off the TeraStation until the disk check is finished. Use the procedure below to run a disk check.

- 1** In Settings, click *Drives*.



- 2** Select *Drives* to check an internal drive or *USB Drives* to check an external drive.



- 3 Select the drive to test, then click *Check Disk*.

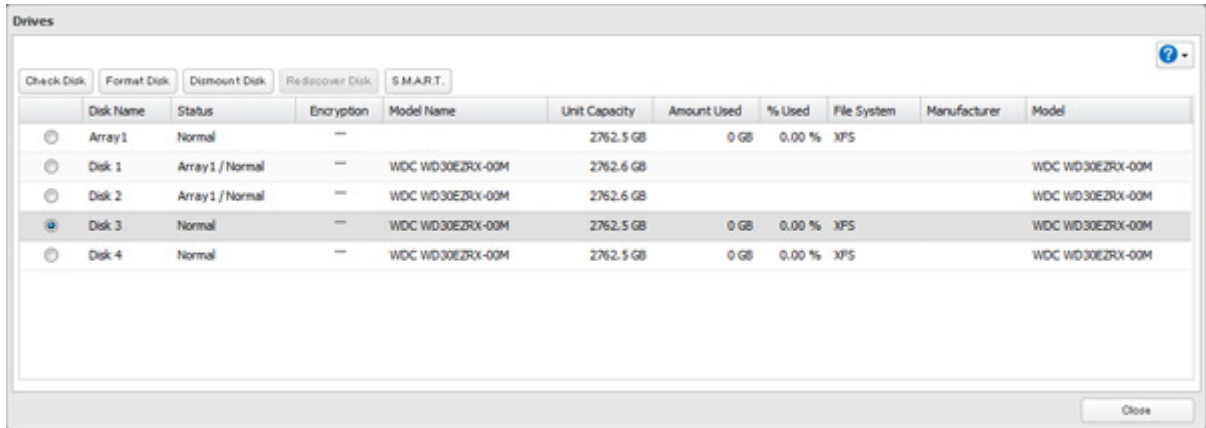

- 4 Click *Check*. You have the option of deleting information files from Mac OS during the check if desired.

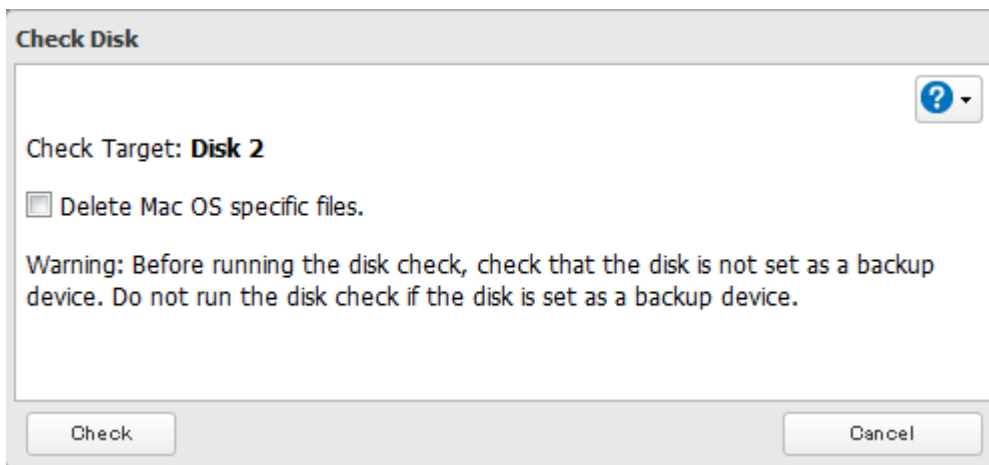

S.M.A.R.T.

S.M.A.R.T. (Self-Monitoring, Analysis, and Reporting Technology) monitors hard drives to detect and report various indicators of reliability, in the hope of anticipating failures. When a failure is anticipated by S.M.A.R.T., the user may choose to replace the drive to avoid outages and data loss. Follow the steps below to check S.M.A.R.T. information for the TeraStation's internal drives.

Note: S.M.A.R.T. information is only available for internal drives.

- 1 In Settings, click *Drives*.



- 2 Click  to the right of "Drives".

- 3 Select a drive to check and click *S.M.A.R.T.*

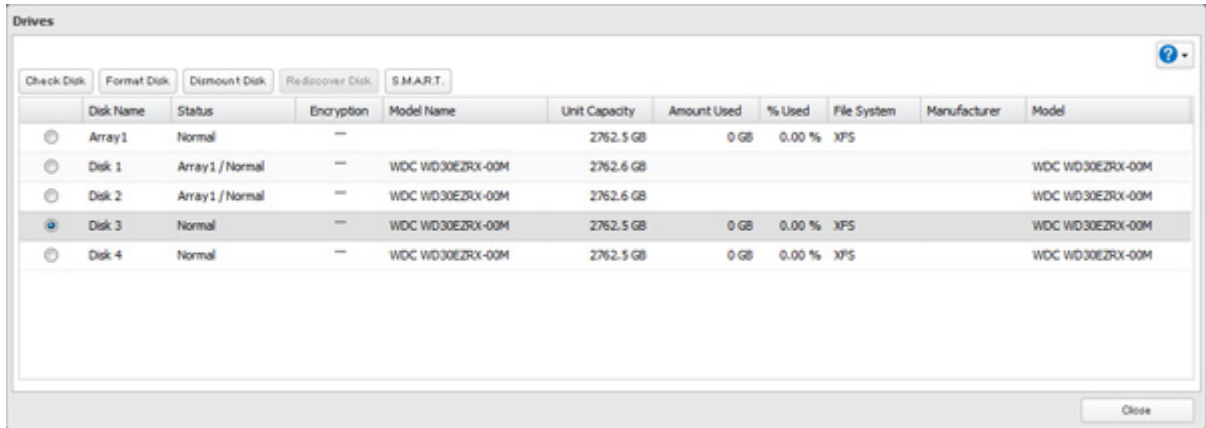

- 4 The S.M.A.R.T. information for the drive will be displayed. Different information may be displayed depending on the brand of drives in your TeraStation. Critical attributes are displayed in bold. Attributes with current value less than or equal to the threshold value may be significant. If an attribute reports a failure, or has had one in the past, it will be displayed in the status column.

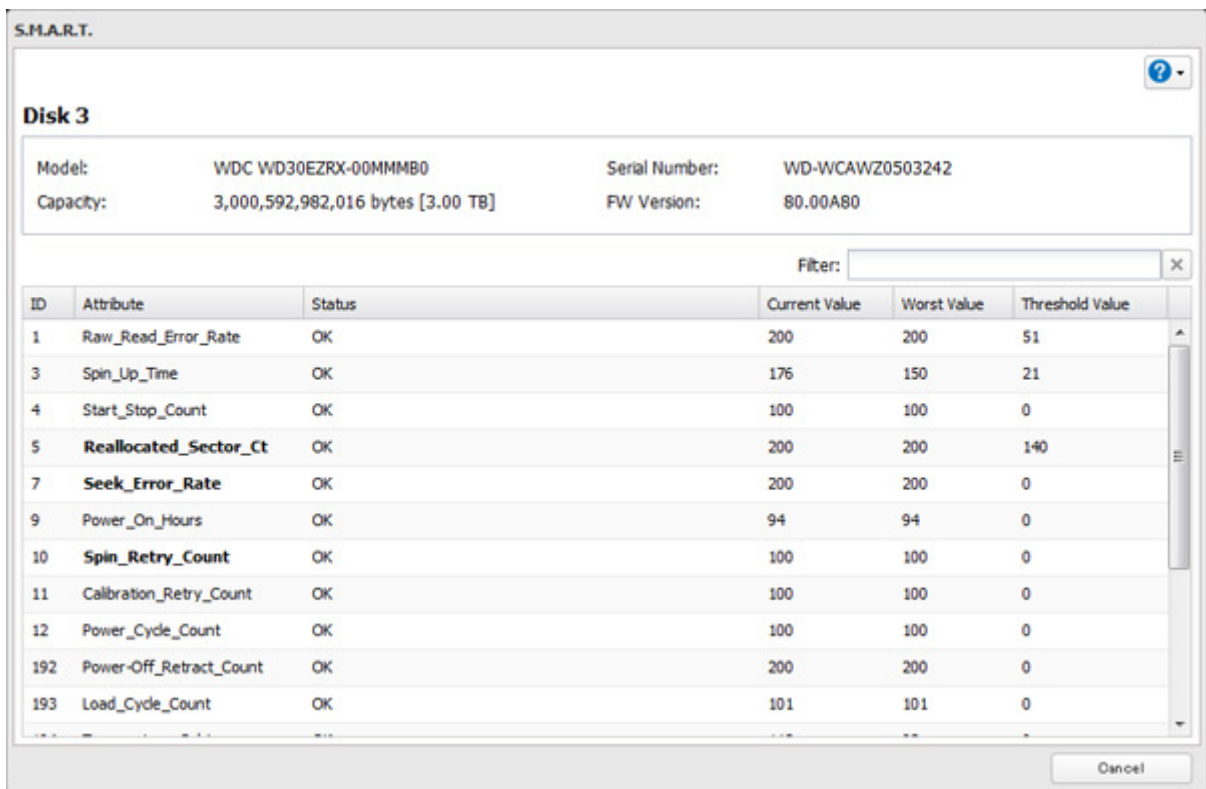

Formatting Drives

Note: Under some circumstances, data deleted when a drive is formatted can be recovered. To ensure that data is "gone forever", a format might not be sufficient. See the "Erase Data on the TeraStation Completely" section below.

- 1 In Settings, click *Drives*.



- 2 Select *Drives* to format an internal drive or *USB Drives* to format an external drive.



- 3 Select the drive to format, then click *Format Disk*.

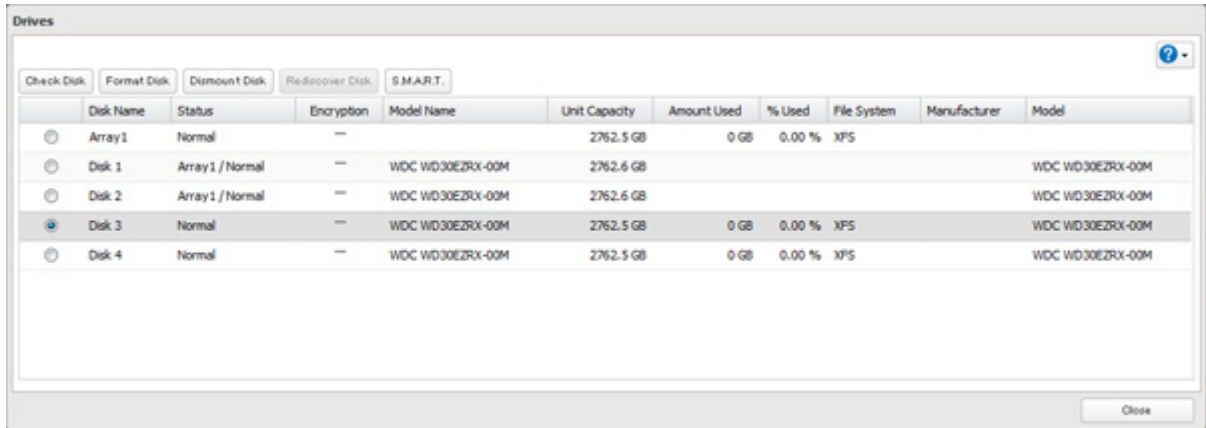

- 4 Select a format type, then click *Format*.

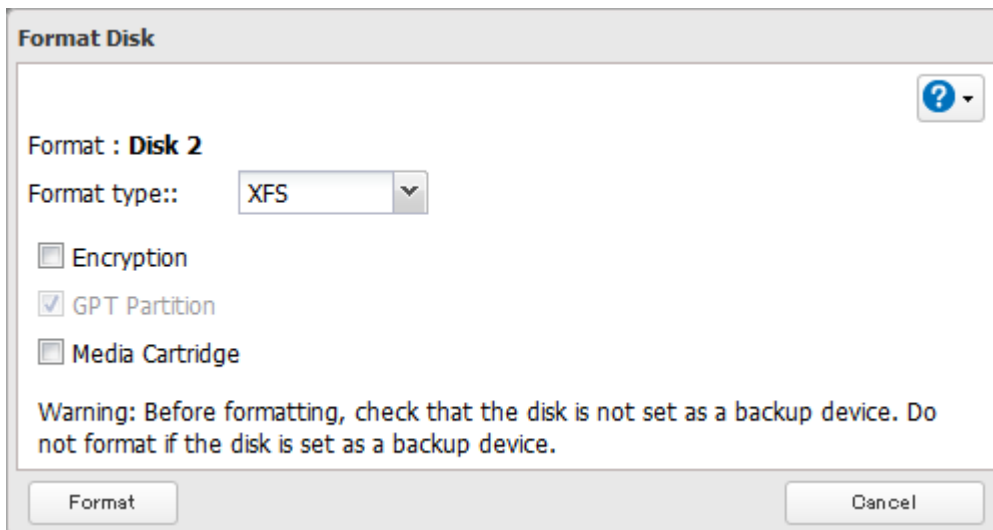

- 5** The "Confirm Operation" screen will open. Enter the confirmation number, then click *OK*.

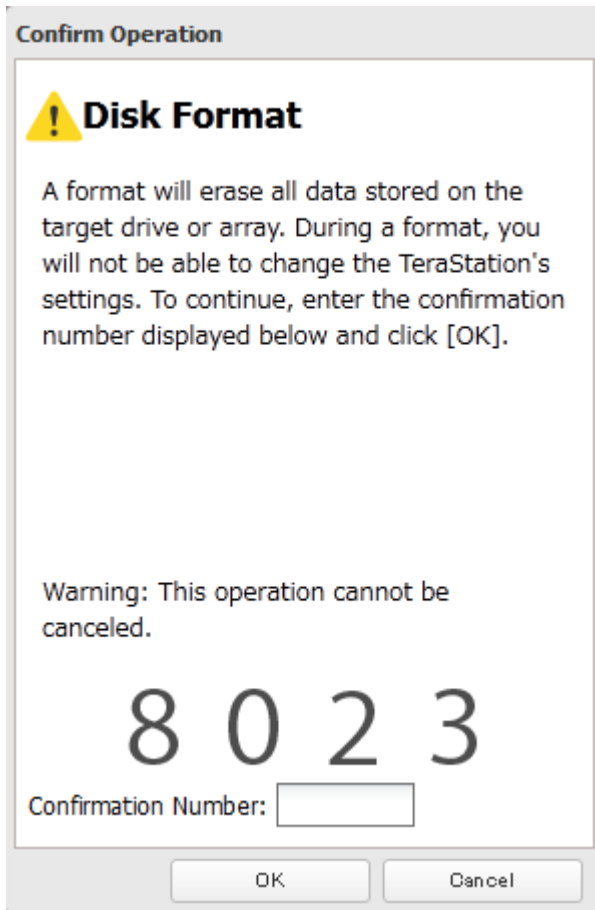

- 6** Depending on the size of your drive, the format may take several minutes or several hours to complete. "Formatting" will be displayed on the LCD display until the format is complete.

Notes:

- Do not turn off or disconnect power to the TeraStation while formatting a hard drive.
- For drives of 2.2 TB or larger, make sure that the "GPT Partition" checkbox is selected.

Encrypting Drives

Internal drives (and arrays) can be encrypted with 128-bit AES during formatting. Encrypted drives and arrays are then readable only from that specific TeraStation. To unencrypt a drive or array, uncheck "Encryption" and format it again.

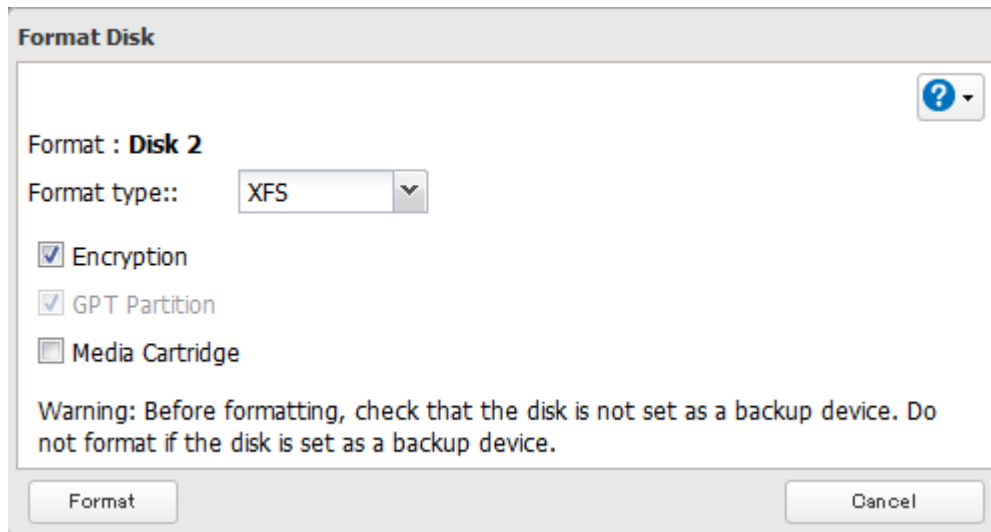

Media Cartridges

If configured as a media cartridge, an internal drive can be used as a removable storage device in the same way as an external drive. Media cartridges can be unplugged and connected to a different TeraStation with all data intact. To configure a drive as a media cartridge, check "Media Cartridge" during formatting. To return it to its original state, uncheck "Media Cartridge" and reformat the drive.

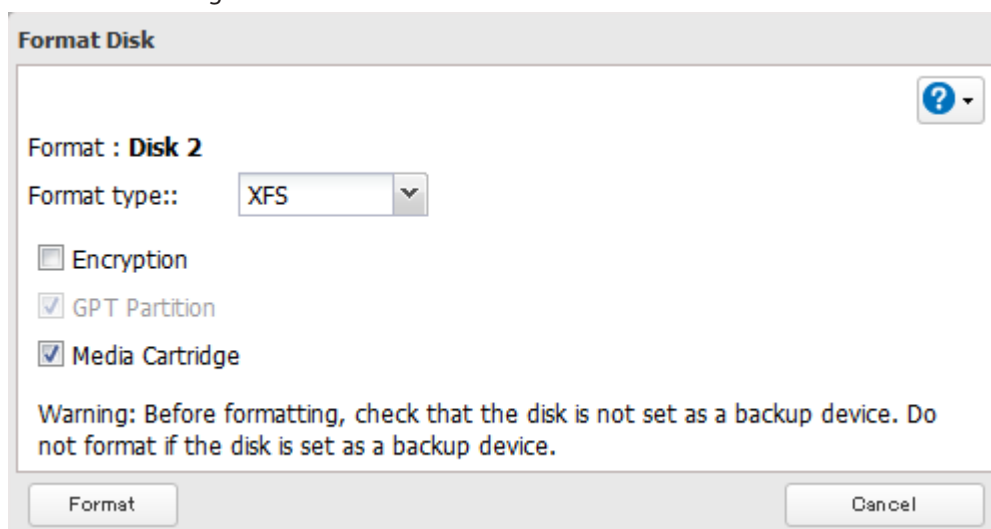

Media cartridges do not support:

- RAID arrays
- LVM volumes
- Access restrictions
- Direct connection to a Windows computer

Notes:

- Don't configure the boot drives (drives 1 and 2) as media cartridges.
- Configure media cartridges from the bottom drive up. For example, if your TeraStation has 4 drives, make drive 4 a media cartridge first, then drive 3 next.

- If the TeraStation fails to boot after drive 1 or 2 is replaced, remove any media cartridges, then replace them after the TeraStation has booted.

Erase Data on the TeraStation Completely

Under some circumstances, data from formatted drives can be recovered. The disk erasure process in this section does a much more thorough job of erasing data. This procedure is recommended for removing all data from a drive in a way that makes it nearly impossible to recover with current tools. All data on the drives is completely erased.

The TeraStation will then be in the following state:

- All drives in JBOD
- An empty shared folder on each drive
- All settings returned to their default values
- All logs deleted

If you remove a drive and then erase all data on the TeraStation, the LCD will show the E22 error message and the number of the removed drive. You can still use the TeraStation.

- 1** In Settings, click *Management*.

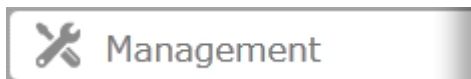

- 2** Click  to the right of "Restore/Erase".

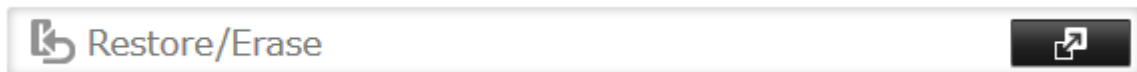

- 3** Click *Erase TeraStation*.

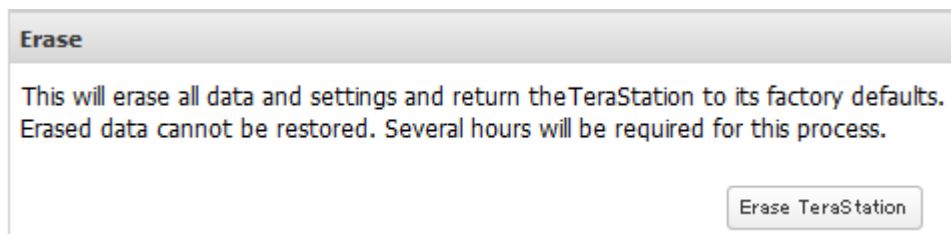

- 4** The "Confirm Operation" screen will open. Enter the confirmation number, then click *OK*.

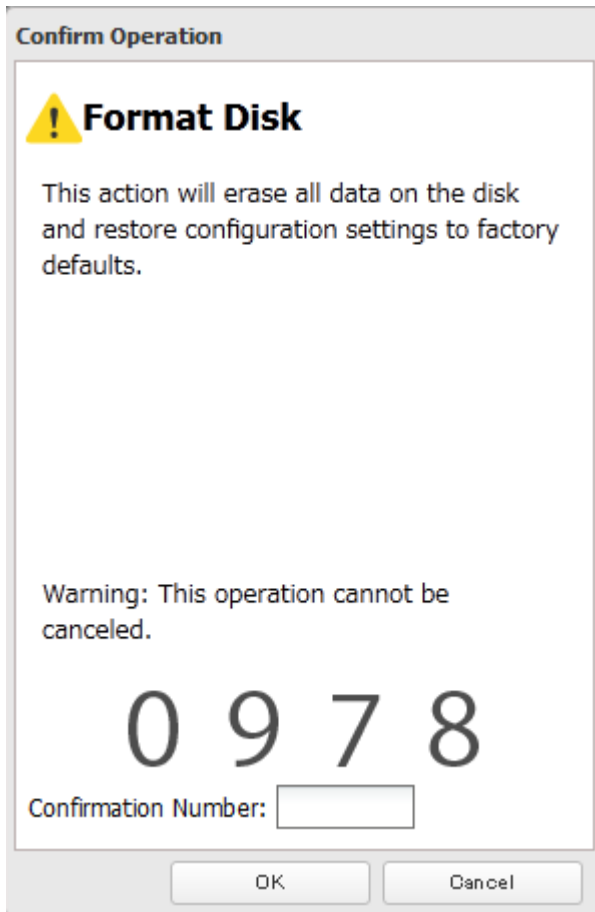

- 5** All data on the TeraStation will be permanently erased.

Disk Quotas

You can set a disk quota to limit drive space for each user or group. You can also set an alert space. If the drive space exceeds the set alert space, an email notification is sent. To configure email notifications for disk quota, refer to the "Email Notification" section in chapter 10.

Notes:

- When using quotas, disable the recycle bin or empty the trash folder often. The limited space includes the space used for trash.
- Quotas apply per drive or per array. If a quota is set to 1 GB, each array or drive can use a maximum of 1 GB.
- Quotas cannot be set for external hard drives connected to the TeraStation and hard drives that are configured as media cartridges.
- If both user and group quotas are configured for a user, the most restrictive quota will always apply.

Quotas for Users

Follow this procedure to limit the shared folder disk space available for a user.

- 1** In Settings, click *File Sharing*.

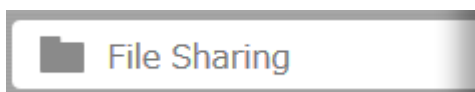

- 2 Click  to the right of "Users".

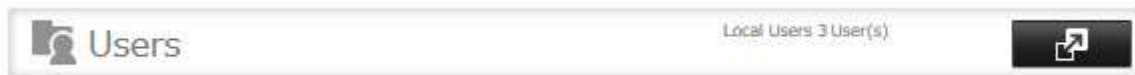

- 3 Select the user whose space will be limited.

- 4 Enable quotas, choose the maximum space the user will be allowed to use, and click *OK*.



Note: If you change the primary group, restart the TeraStation to apply the quota settings.

- 5 Click *OK*.

Quotas for Groups

Follow the procedure below to limit the space for shared folders that each group can use.

- 1 In Settings, click *File Sharing*.

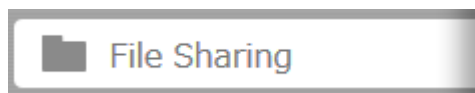



- 2 Click  to the right of "Groups".

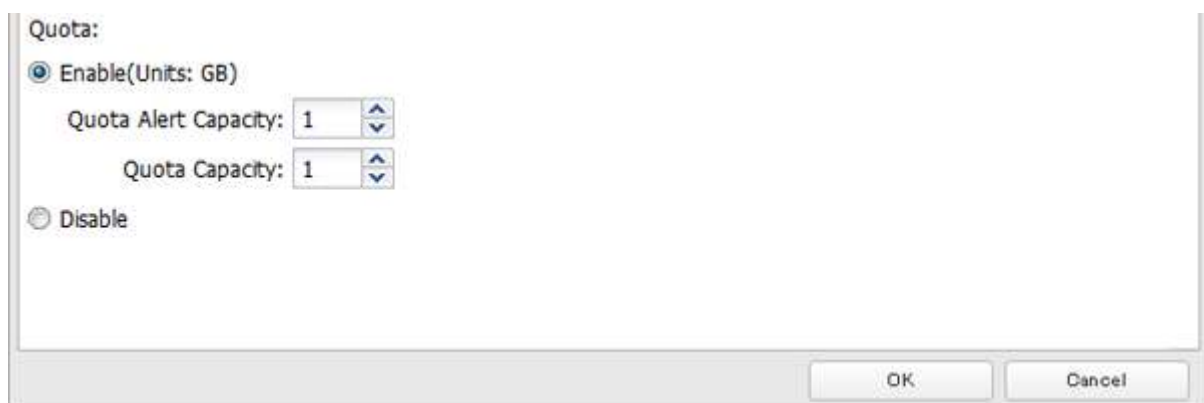

- 3 Select the group whose space will be limited.

- 4 Enable quotas, choose the maximum space the group is allowed, and click *OK*.



- Click *Close*.
- Click  to the right of "Users".



- Select the user who will inherit the group quota settings.
- Change the user's primary group to the group with the quota, then click *OK*.
- Click *OK*.

Size Limits

If LVM is enabled, volumes can be created with maximum size limits.

- In Settings, click *Drives*.

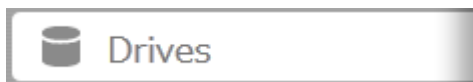

- Click  to the right of "LVM".

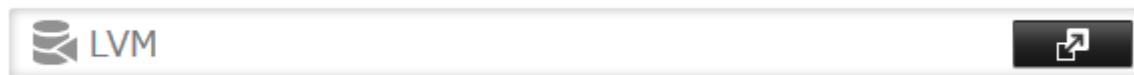

- Select the drive or array where the volume will be located and click *Enable LVM on Volume*.

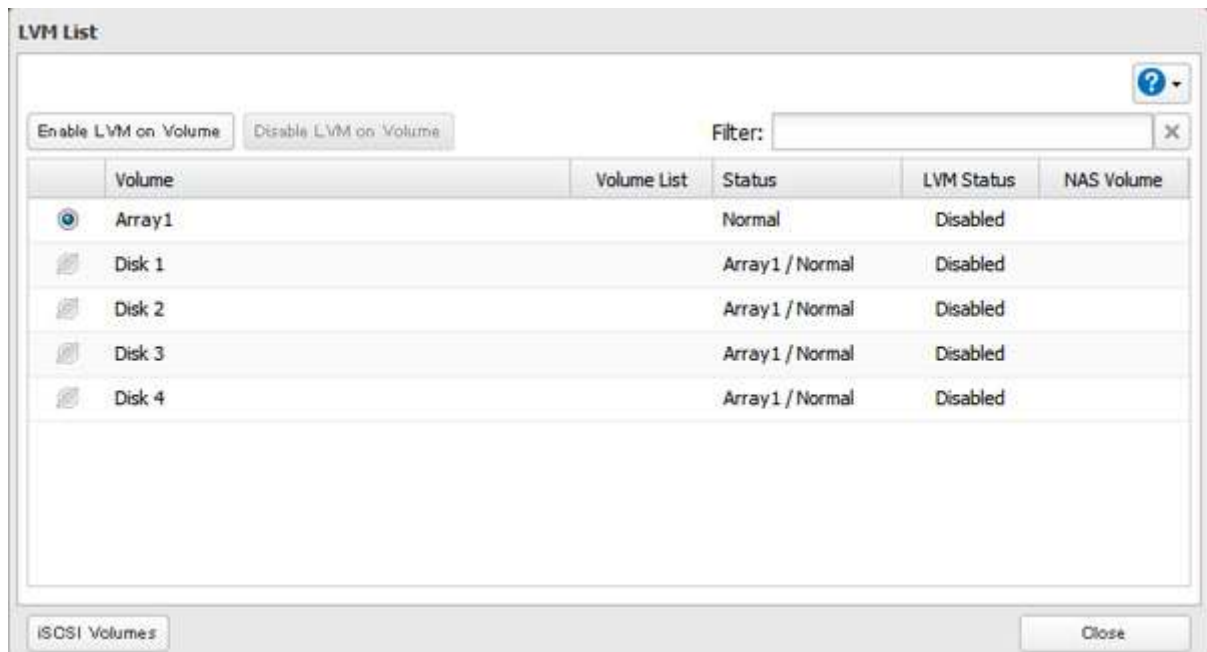

- The "Confirm Operation" screen will open. Enter the confirmation number, then click *OK*.
- Click *OK*.

6 Click *Edit* under "NAS Volume".

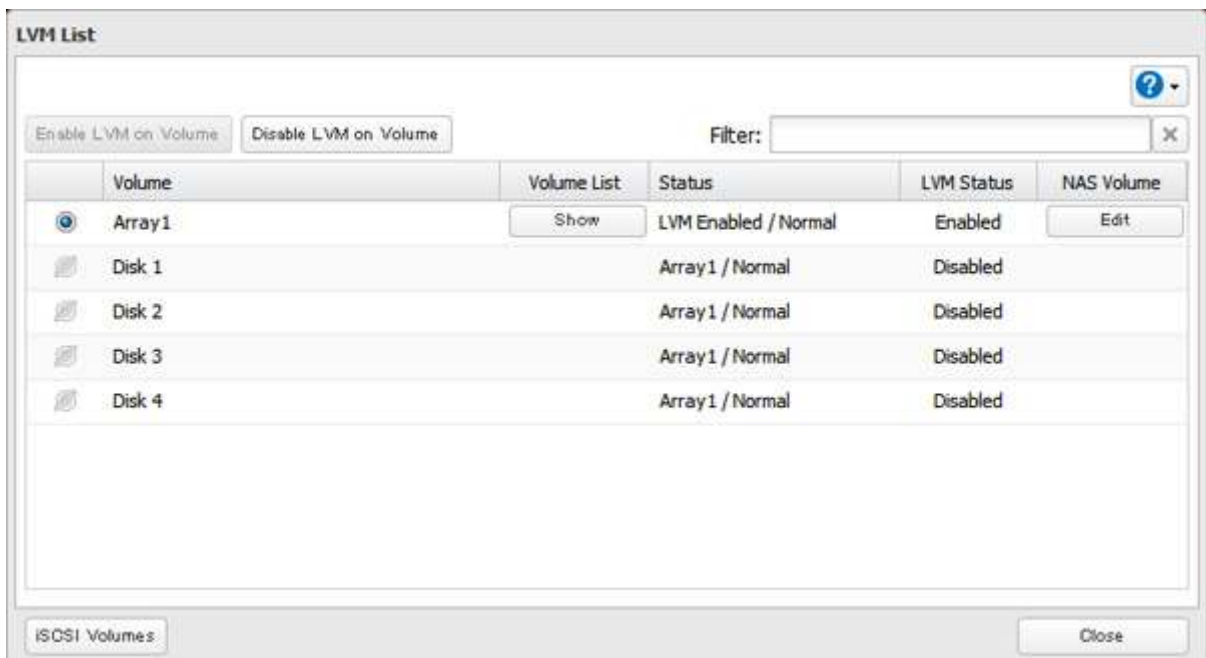

7 Click *Create Volume*.



- 8** Configure the desired settings, then click *OK*.

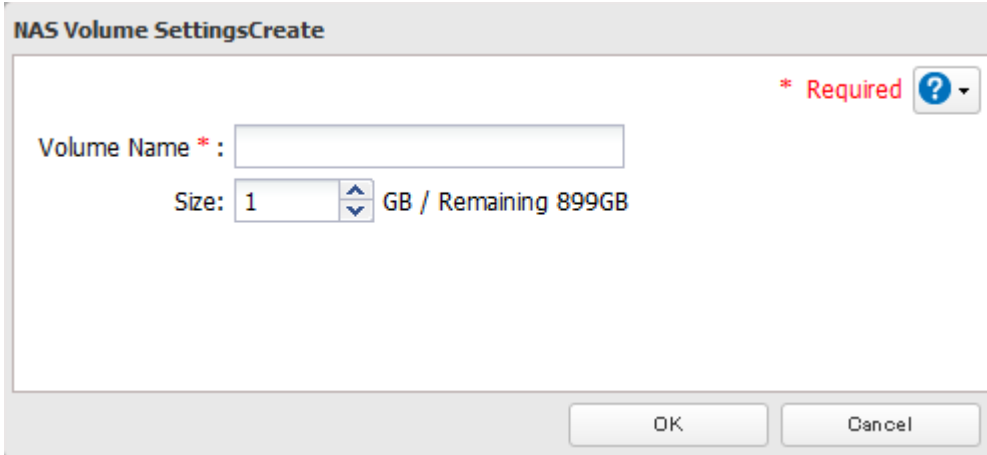

- 9** Click *OK*.
- 10** Click *Close*.
- 11** Click *Close*.
- 12** Navigate to *File Sharing - Folder Setup*.

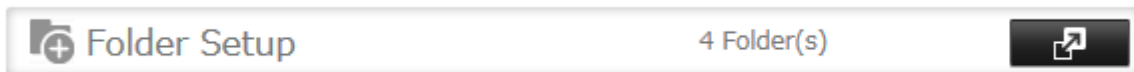

- 13** Click *Create Folder*.
- 14** Configure the settings.
- 15** Select the volume that you created and click *OK*.

Using the TeraStation as an iSCSI Device

Introduction

iSCSI is a protocol for carrying SCSI commands over IP networks. Unlike traditional SAN protocols such as Fibre Channel, which requires special-purpose cabling, iSCSI can be run over long distances using existing network infrastructure. Normal Windows formatting such as NTFS is supported.

Differences Between NAS and iSCSI

With iSCSI, the TeraStation is connected to a single computer, such as a server. Other computers on the network access files on the TeraStation through the computer it's connected to. The TeraStation can be used as a local drive from Windows Server. Features of Windows Server such as Active Directory can be used normally.

As a NAS, the TeraStation is a server, and computers (including other servers) on the network can access shared folders on it directly. A separate server is not required, and features such as backup are built-in.

Network Configuration

Use gigabit or faster network equipment with iSCSI. For best results, a dedicated network for iSCSI is recommended, separate from the regular network. Use fixed IP addresses for storage devices such as the TeraStation.

Installing a Connection Tool

Windows XP, Windows Server 2003

Before using any iSCSI equipment, download and install the iSCSI connection software "Microsoft iSCSI Software Initiator" from the Microsoft website.

If using TS5000 series TeraStations, you can also use Buffalo iSCSI Connection Tool to connect to an iSCSI hard drive.

Windows Vista or later, Windows Server 2008 or later

The Microsoft iSCSI Software Initiator is already installed on your computer. You don't need to download and install it.

If using TS5000 series TeraStations, you can also use Buffalo iSCSI Connection Tool to connect to an iSCSI hard drive.

Creating a iSCSI Volume

To use the TeraStation as an iSCSI hard drive, create a volume first. Configure the TeraStation as described below.

Notes:

- If the LVM settings are changed, all data on the volume will be erased. Before changing any settings, back up any important data.
- The TS5000 and TS5000N can have up to 255 volumes, but we recommend using only a maximum of 32. Exceeding this volume amount may cause irreparable damage to the unit.

1 In Settings, click *Drives*.



Note: Steps 2–6 below describe the procedure to enable LVM for specifying a volume size or changing it later. LVM does not need to be enabled for a drive to be used as an iSCSI hard drive, as you can still create an iSCSI volume from the entire drive or array. However, enabling LVM is recommended for drives that will be used for iSCSI.

To use whole drive or array as an iSCSI hard drive, skip to step 7.

2 Click  to the right of "LVM".



- 3 Select the drive or array where the volume will be created and click *Enable LVM on Volume*.

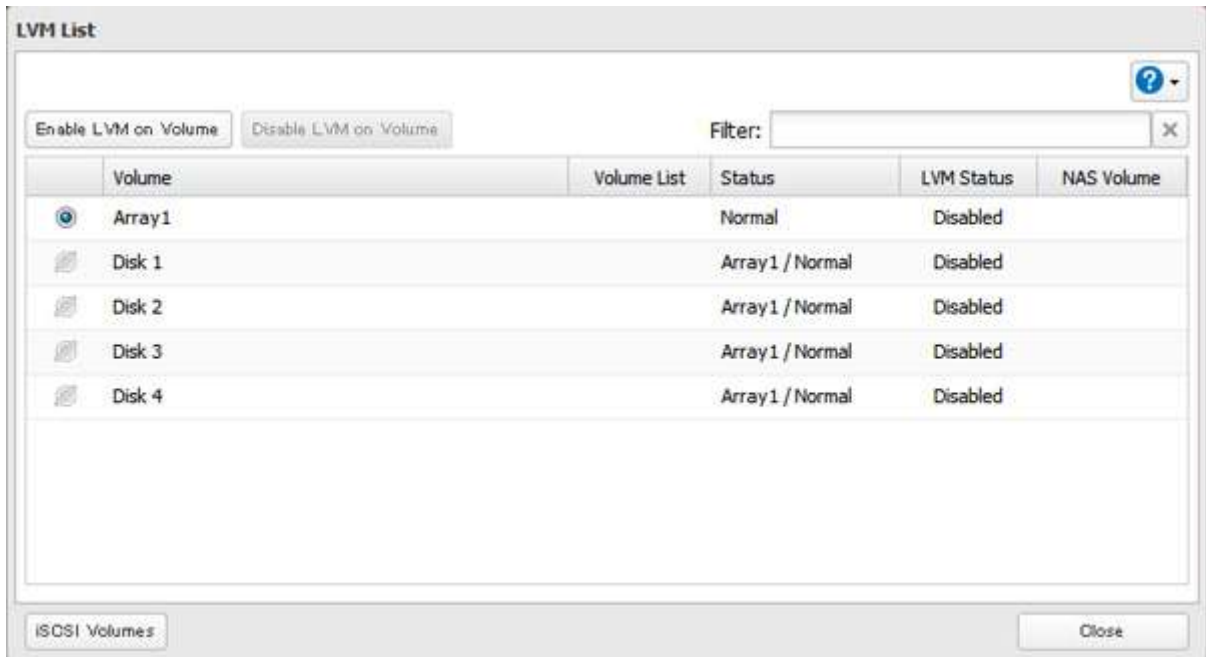

- 4 The "Confirm Operation" screen will open. Enter the confirmation number, then click *OK*.

- 5 Click *OK*.

- 6 Click *Close*.

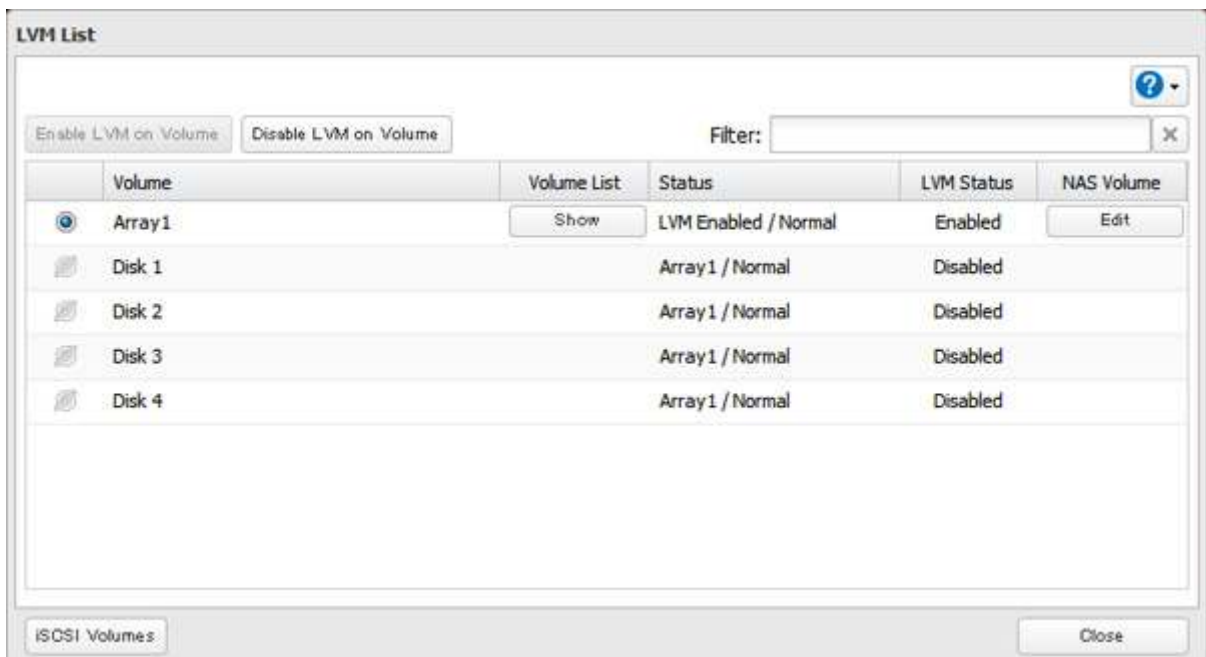

Note: If you click *Show* under "Volume List", the volumes will be listed on the screen and you can see if these volumes are being used as iSCSI or NAS.

- 7 Move the iSCSI switch to the  position to enable iSCSI.

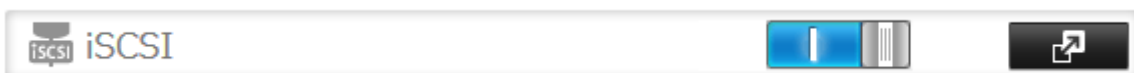

- 8 Click  to the right of "iSCSI".

9 Click *Create Volume*.

10 Enter a volume name, volume description, volume, and size (if you enabled LVM), then click *OK*.

The volume size that you specify here can be changed later. To change the volume size, refer to the "Expanding Volume Sizes" section below.

11 The "Confirm Operation" screen will open. Enter the confirmation number, then click *OK*.

12 Click *OK*, then *Close*.

Creating an iSCSI volume is finished.

Note: If you click *Disable Connection* for the selected volume in *Drives - iSCSI* in Settings, the selected iSCSI volume can no longer be accessed. If you click *Enable Connection*, the volume will become accessible from the iSCSI initiator software.

Connecting or Disconnecting Volumes

There are two methods to connect or disconnect volumes. One uses the pre-installed Microsoft iSCSI Initiator on Windows; the other uses Buffalo iSCSI Connection Tool. The method to use Buffalo iSCSI Connection Tool is available only to customers with TS5000 series TeraStations.

Note: By default, the IP address of the TeraStation is automatically assigned from a DHCP server. However, in this case, if you turn off and restart the TeraStation, the IP address may be changed and the volumes on the TeraStation may not be accessible. To avoid changing the IP address unexpectedly, using a fixed IP address for the TeraStation is recommended.

Using Microsoft iSCSI Initiator

Connecting Volumes

To connect a volume using Microsoft iSCSI Initiator from a Windows computer, follow the procedure below.

Note: Do not shut down the TeraStation while connecting to an iSCSI volume. It may cause unexpected data erasure. Make sure all connections are disconnected before shutdown.

1 In Windows, navigate to *Control Panel - Administrative Tools - iSCSI Initiator*.

- 2 Enter the IP address of the TeraStation into the "Target" field and click *Quick Connect*.

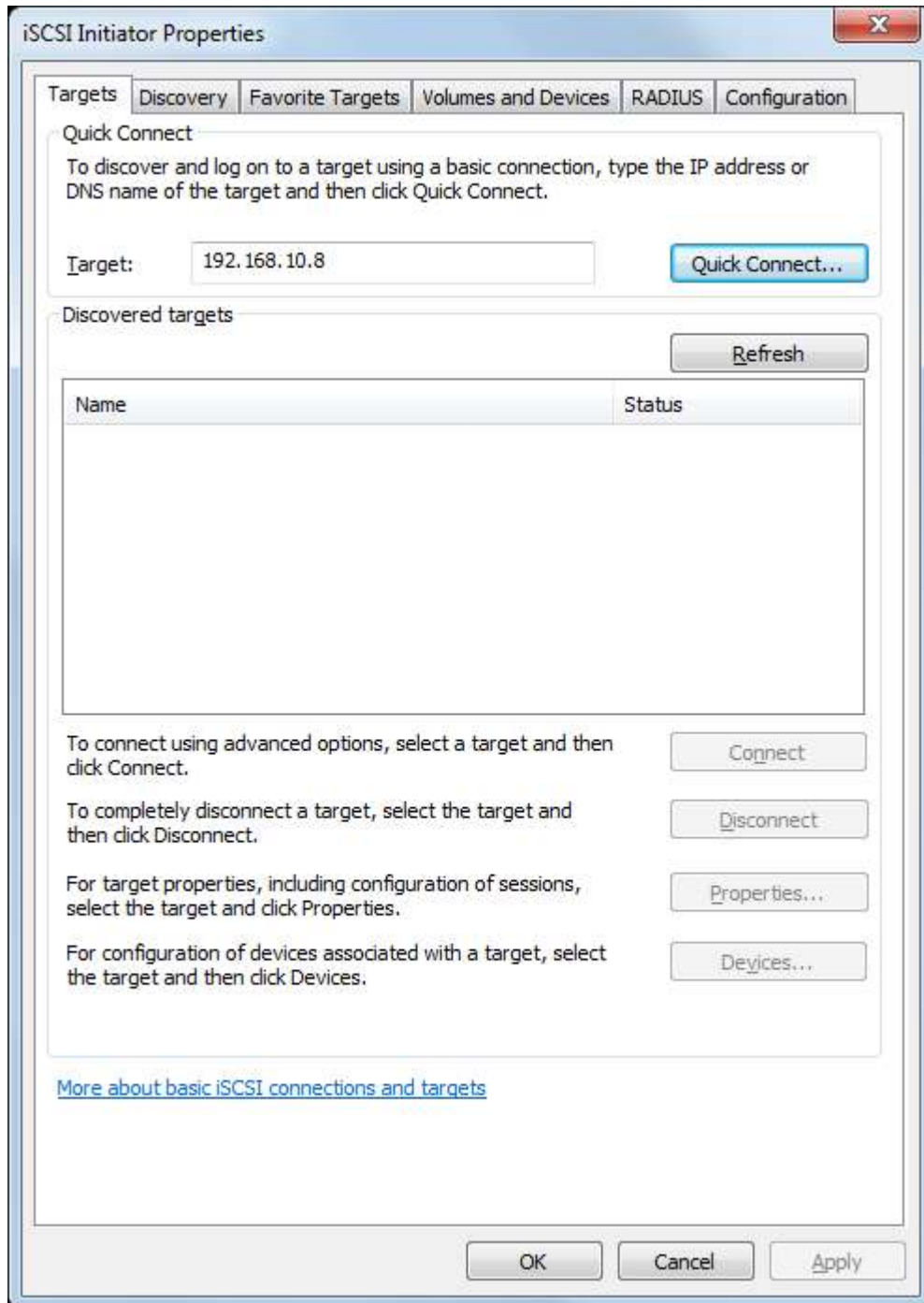

- 3 Confirm if the connection is established and click *Done*.

Connecting a volume is finished.

If using the connected volume for the first time, the volume should be formatted to be used as a local drive. Follow the procedure below for formatting.

- 1 In Windows, navigate to *Control Panel - Administrative Tools - Computer Management*.

- 2 Click *Disk Management*.

When the "Initialize Disk" screen is displayed, click *OK* without changing any settings.

- 3** Right-click the disk volume that shows the status "Unallocated" and click *New Simple Volume* from the displayed menu. Follow the screen to finish formatting.

Formatting a volume is finished. When the formatting process is completed, the drive will be visible as an icon in Computer or My Computer and can be used as a normal drive on the computer.

Disconnecting a Volume

- 1** In Windows, navigate to *Control Panel - Administrative Tools - iSCSI Initiator*.
The status of the connecting volume will be displayed as "Connected" under "Discovered targets".
- 2** Select a volume to disconnect and click *Disconnect*.
- 3** Click *Yes*.
- 4** When the volume status is displayed as "Inactive", the disconnection was carried out properly.
Disconnecting a volume is finished.

Using Buffalo iSCSI Connection Tool

Connecting a Volume

To connect a volume using Buffalo iSCSI Connection Tool from a Windows computer, follow the procedure below.

- 1** Click *Start - Programs - Buffalo - iSCSI Connection Tool - iSCSI Connection Tool*.
iSCSI Connection Tool will open.

- 2** Select the TeraStation name from the drop-down menu of "Target" and click *Register iSCSI Device*.

Buffalo iSCSI Connection Tool

File Configuration Help

Target

Model Series

IP Address Subnet Mask

Firmware MAC Address

iSCSI Service

Volume

- 3** Click *OK*.

- 4 Select a volume to connect from the drop-down menu of "Volume" and click *Connect*.

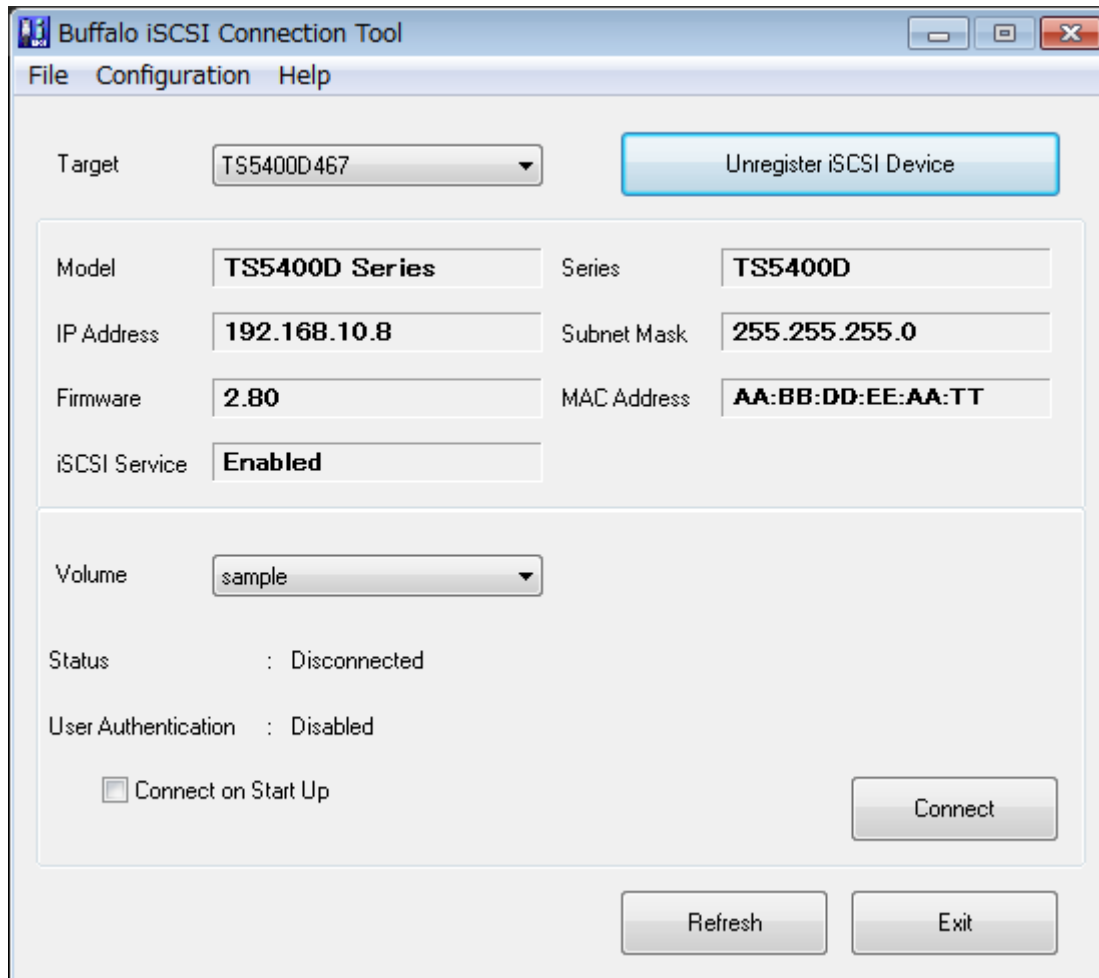

- 5 Click *OK*.

Connecting a volume is finished.

If using the connected volume for the first time, the volume should be formatted to be used as a local drive. Follow the procedure below for formatting.

- 1 In Windows, navigate to *Control Panel - Administrative Tools - Computer Management*.
- 2 Click *Disk Management*.
When the "Initialize Disk" screen is displayed, click *OK* without changing any settings.
- 3 Right-click the disk volume that shows the status "Unallocated" and click *New Simple Volume* from the displayed menu. Follow the screen to finish formatting.

Formatting a volume is finished. When the formatting process is completed, the drive will be visible as an icon in Computer or My Computer and can be used as a normal drive on the computer.

Disconnecting a Volume

- 1 Click *Start - Programs - Buffalo - iSCSI Connection Tool - iSCSI Connection Tool*.
iSCSI Connection Tool will open.

- 2** Select a volume to disconnect from the drop-down menu of "Volume" and click *Disconnect*.

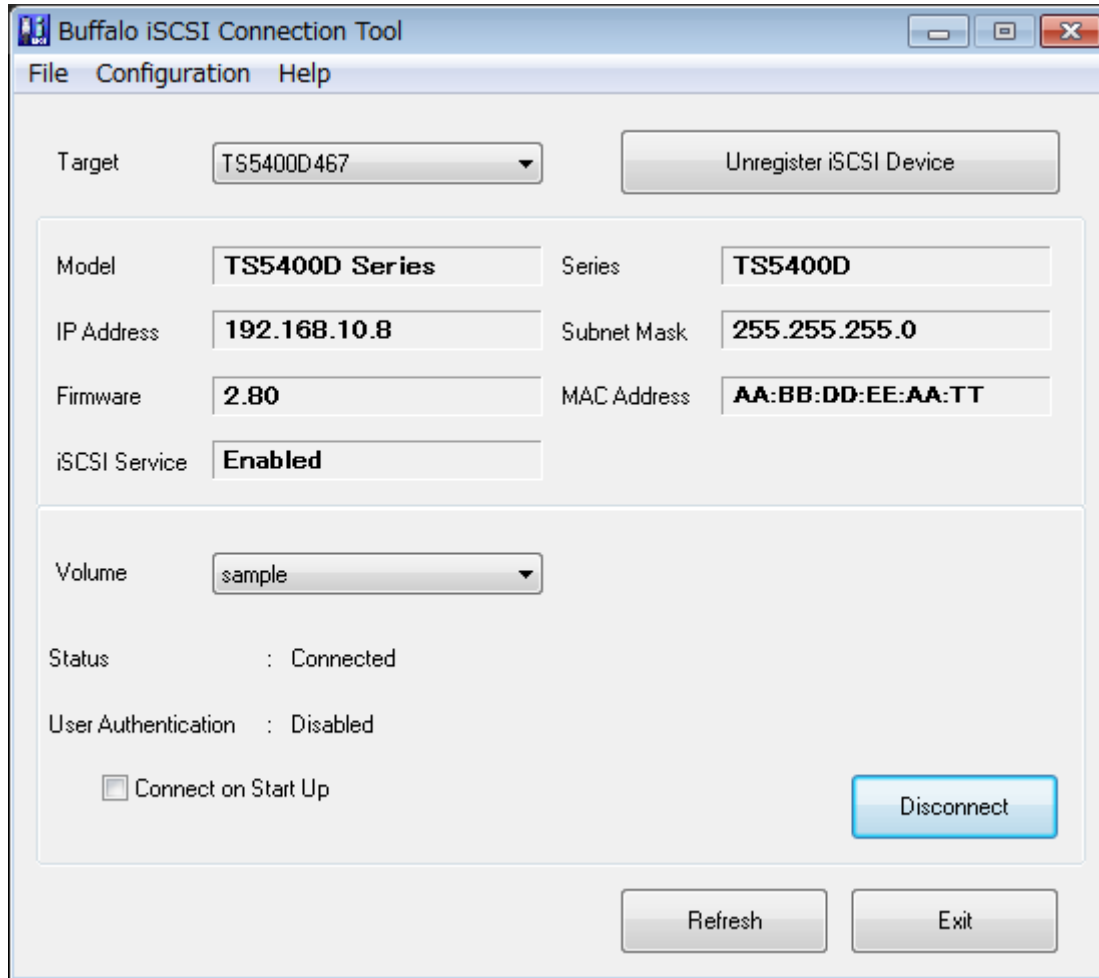

- 3** Click Yes.

- 4** Click OK.

- 5 Select the TeraStation name from the drop-down menu of "Target" and click *Unregister iSCSI Device*.

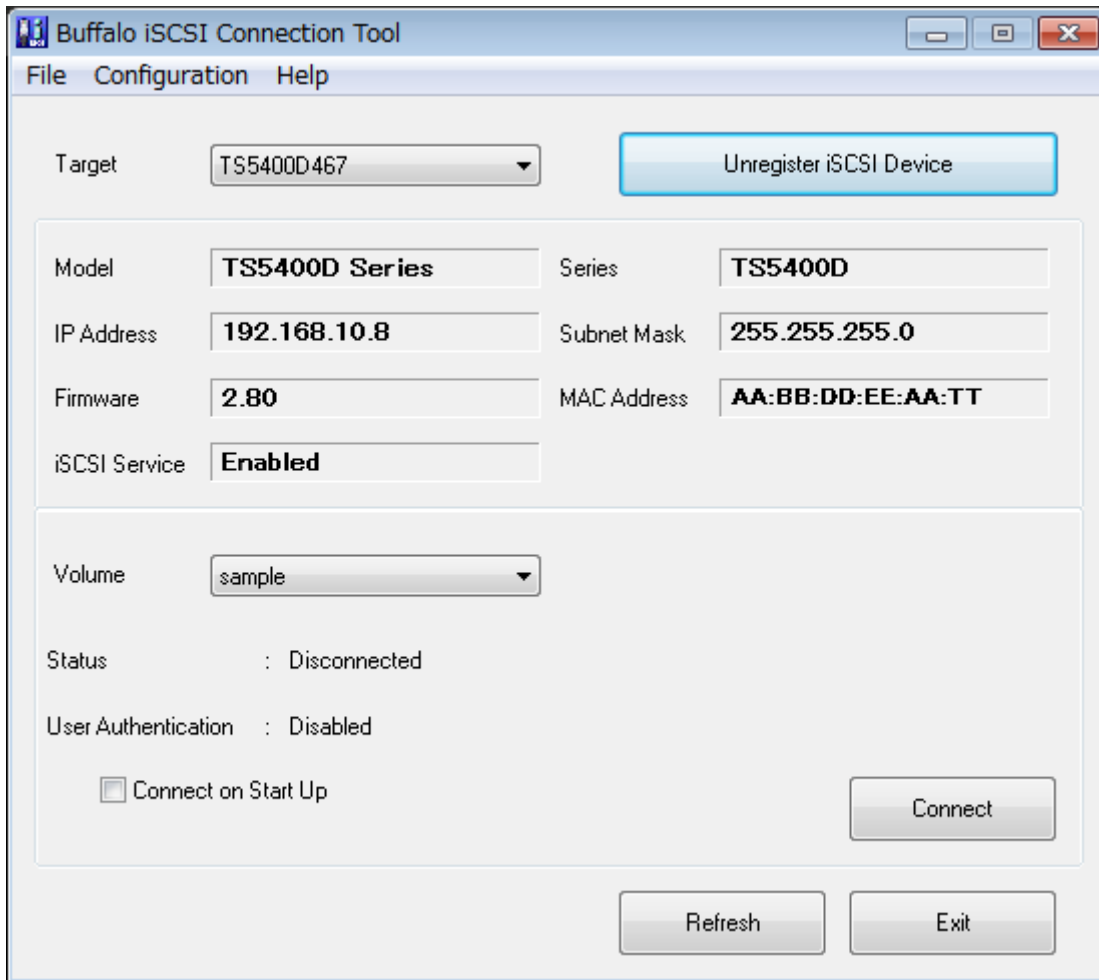

- 6 Click *OK*.

Disconnecting a volume is finished.

Using with Multiple Computers

If the TeraStation is divided into multiple volumes (or drives), it can be used with multiple computers. However, multiple computers cannot be accessed from one volume (or one drive) at the same time.

Checking Whether iSCSI Volume is Connected

To check whether an iSCSI volume is connected, navigate to *Drives - iSCSI*. Current volumes will be listed. If "Connected" is displayed under "Connection", the volume is currently connected from the client.

Configuring Access Restrictions

A username and password can be configured for the entire iSCSI volume or each existing volume. Access restrictions can be configured so that entering a username and password is required for each connection.

The TeraStation can perform mutual authentication (two-way authentication). Dual passwords ensure that only authorized client computers can access the volume on the TeraStation.

Follow the procedure below to enable access restrictions.

Configuring Access Restrictions for the Entire TeraStation

- 1 In Settings, click *Drives*.



- 2 Click  to the right of "iSCSI".



- 3 Click the *Security* tab.

- 4 Click *Edit* under "Access Control (Target Discovery)".

- 5 Enable access restrictions, enter the username and password, and click *OK*.

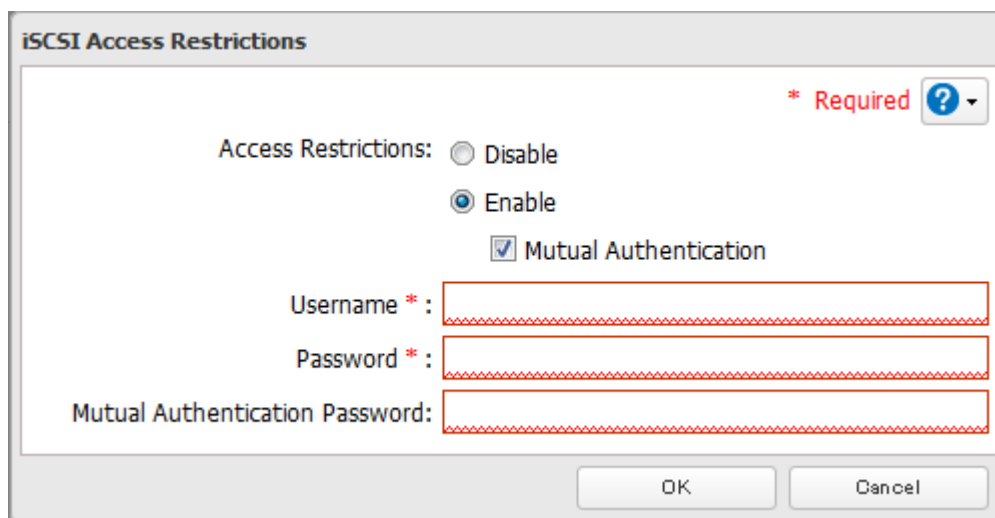
A screenshot of the 'iSCSI Access Restrictions' dialog box. The dialog has a title bar with the text 'iSCSI Access Restrictions'. Inside, there are radio buttons for 'Access Restrictions: Disable' and 'Enable', with 'Enable' selected. Below that is a checked checkbox for 'Mutual Authentication'. There are three text input fields: 'Username *', 'Password *', and 'Mutual Authentication Password:'. Each field has a red dashed border. At the bottom right, there are 'OK' and 'Cancel' buttons. A red asterisk and the word 'Required' are visible next to a question mark icon in the top right corner.

Note: To enable mutual authentication in addition to username and password authentication, check "Mutual Authentication" and enter the mutual authentication password.

To search or connect the volume which has mutual authentication enabled from Microsoft iSCSI Initiator, mutual CHAP secret settings should be configured.

- 6 Click *Close*.

Configuring access restrictions for the entire TeraStation is finished.

Connecting Volumes on the Access-Restricted TeraStation

Using Microsoft iSCSI Initiator

If access restrictions are configured for the entire iSCSI volume, that volume will not be detected by Microsoft iSCSI Initiator. To connect that volume, the configured username and password should be authenticated.

- 1 Open the Microsoft iSCSI Initiator.

- 2 Register the mutual authentication password to your computer first. If you didn't enable mutual authentication, skip this step.

Click *CHAP* in the "Configuration" tab. In the "Initiator CHAP secret" field, enter the configured mutual authentication password and click *OK*.

- 3** In the "Discovery" tab, click *Discover Portal*.
- 4** Enter the TeraStation's IP address in the "IP address or DNS name" field.
- 5** Click *Advanced*.
- 6** Check "Enable CHAP log on" and enter the configured username to the "Name" field and password into the "Target secret" field.
If the mutual authentication is enabled, check "Perform mutual authentication".
- 7** Click *OK* twice.
- 8** In the "Targets" tab, select the volume from "Discovered targets" and click *Connect - OK*.
- 9** If the status of the selected volume is displayed as "Connected" under "Discovered targets", the connection is established properly.

Accessing the volume on the access-restricted TeraStation is finished.

Using iSCSI Connection Tool

- 1** Open iSCSI Connection Tool.
- 2** Select the TeraStation name from the drop-down menu of "Target" and click *Register iSCSI Device*.

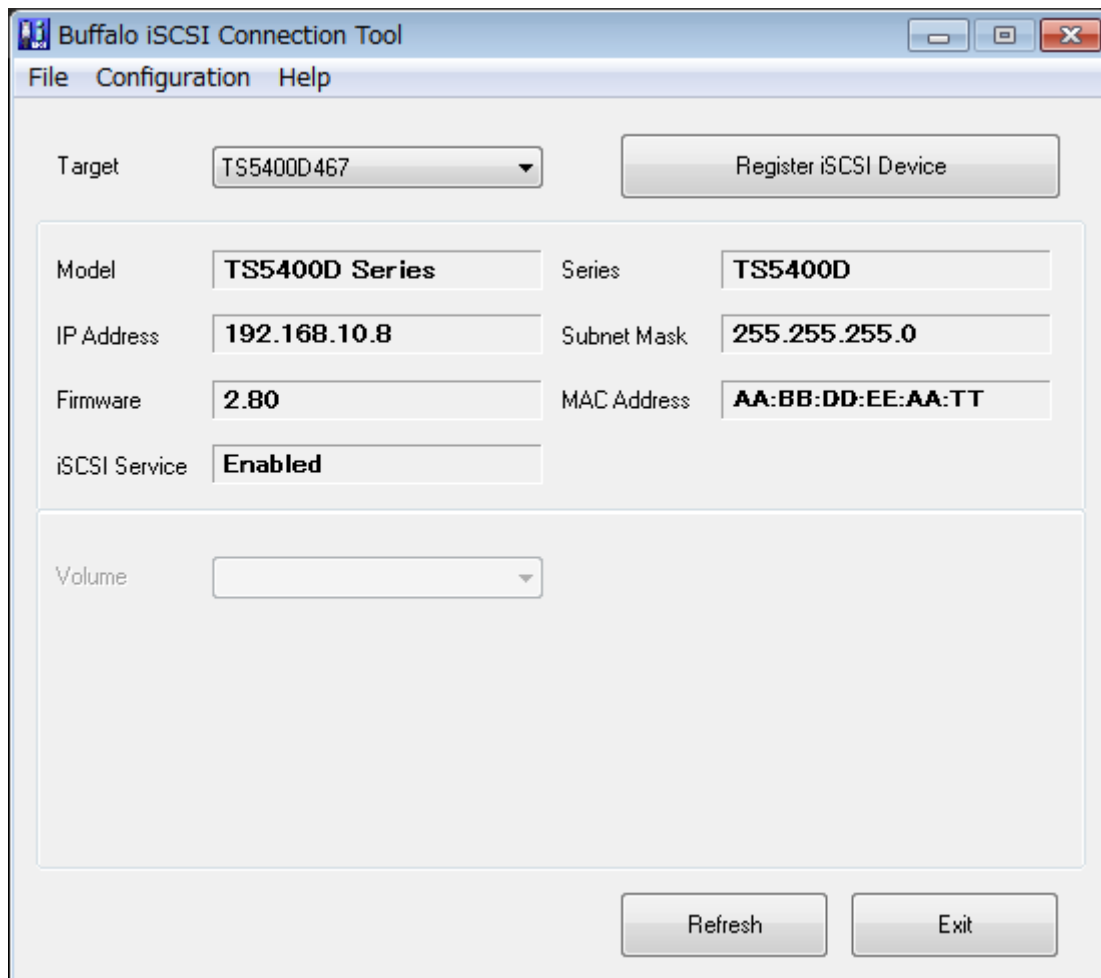

- 3** The screen to enter the username and password will be displayed. Enter the configured username and password from step 5 of the "Configuring Access Restrictions for the Entire TeraStation" section above and click *OK*.

If mutual authentication is enabled, check "Mutual Authentication", then click *OK*.



The "User Authentication" dialog box has a title bar with a close button (X). The main area contains the text "Enter username and password." Below this are two text input fields: "Username" and "Password". At the bottom left, there is a checked checkbox labeled "Mutual Authentication". At the bottom right, there are two buttons: "OK" and "Cancel".

- 4** If "Mutual Authentication" is checked, the following screen will be displayed. Enter the mutual authentication password and click *OK*.

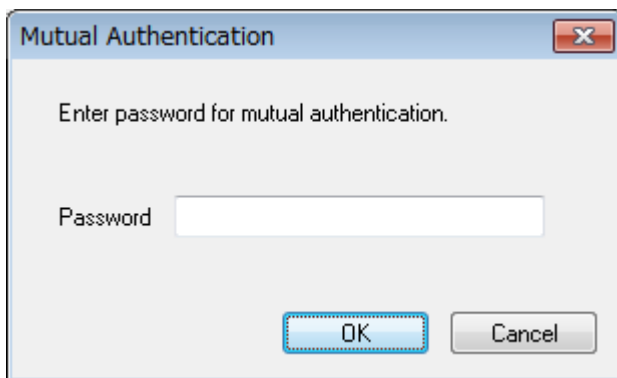

The "Mutual Authentication" dialog box has a title bar with a close button (X). The main area contains the text "Enter password for mutual authentication." Below this is a single text input field labeled "Password". At the bottom right, there are two buttons: "OK" and "Cancel".

- 5** When authentication is successful, click *OK*.

- 6** Select a volume to connect from the drop-down menu of "Volume" and click *Connect*.

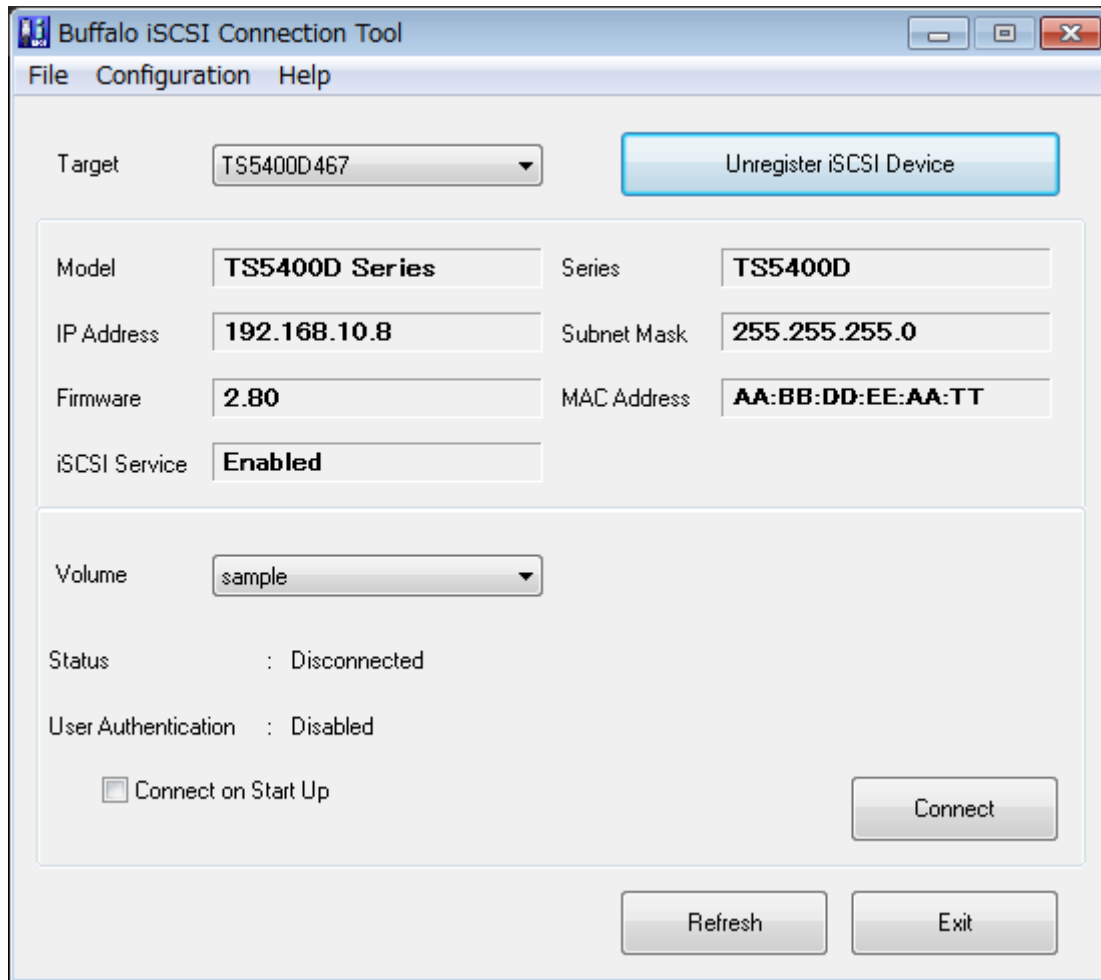

- 7** Click *OK*.

Accessing the volume on the access-restricted TeraStation is finished.

Configuring Access Restrictions for Individual Volumes

If access restrictions are configured for a volume, that volume cannot be accessed unless the username and password are authenticated.

- 1** In Settings, click *Drives*.



- 2** Click  to the right of "iSCSI".

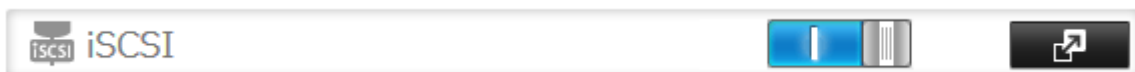

- 3** Click the volume to configure access restrictions.

- 4 Enable access restrictions, enter a client IQN (optional), username, and password, and click *OK*.

The screenshot shows the 'Editing iSCSI Volume' dialog box. The 'General' tab is selected, and the 'Volume Connection' is set to 'Enable'. The 'Volume Name' is 'sample' and the 'Volume Description' is empty. The volume is 'Array1 / 2762 GB' with a size of '10 GB + 0 GB = 10GB / Remaining 2752GB' and an 'IQN' of 'iqn.2004-08.jp.buffalo.cc52afea8467.sample'. The 'Access Restrictions' section is also active, with 'Access' set to 'Enable'. It includes fields for 'Client IQN', 'Username', 'Password', and 'Mutual Authentication Password'. The 'Mutual Authentication' checkbox is checked, and the 'Disable' radio button is unselected. At the bottom, there are 'Advanced Settings', 'OK', and 'Cancel' buttons.

Note: To enable mutual authentication, check "Enable Mutual Authentication" in the screen above and enter the mutual authentication password.

- 5 The "Confirm Operation" screen will open. Enter the confirmation number, then click *OK*.

- 6 Click *OK*, then *Close*.

Configuring access restrictions for each iSCSI volume is finished.

Connecting to Individual Volumes that are Access-Restricted

Using Microsoft iSCSI Initiator

- 1 Open the Microsoft iSCSI Initiator.
- 2 Register the mutual authentication password to your computer first. If you didn't enable the mutual authentication, skip this step.
Click *CHAP* in the "Configuration" tab. In the "Initiator CHAP secret" field, enter the configured mutual authentication password and click *OK*.
- 3 In the "Discovery" tab, click *Discover Portal*.
- 4 Enter the TeraStation's IP address in the "IP address or DNS name" field.
- 5 Click *Advanced*.
- 6 Check "Enable CHAP log on" and enter the configured username to the "Name" field and password into the "Target secret" field.

If the mutual authentication is enabled, check "Perform mutual authentication".

- 7** Click *OK* twice.
- 8** In the "Targets" tab, select the volume from "Discovered targets" and click *Connect*.
- 9** Click *Advanced*.
- 10** Check "Enable CHAP log on" and enter the configured username into the "Name" field and password into the "Target secret" field.
If mutual authentication is enabled, check "Perform mutual authentication".
- 11** Click *OK* twice.
- 12** If the status of the selected volume is displayed as "Connected" under "Discovered targets", the connection is established properly.

Accessing the access-restricted volume is finished.

Using Buffalo iSCSI Connection Tool

- 1** Open the Buffalo iSCSI Connection Tool.
- 2** Select the TeraStation name from the drop-down menu of "Target" and click *Register iSCSI Device*.

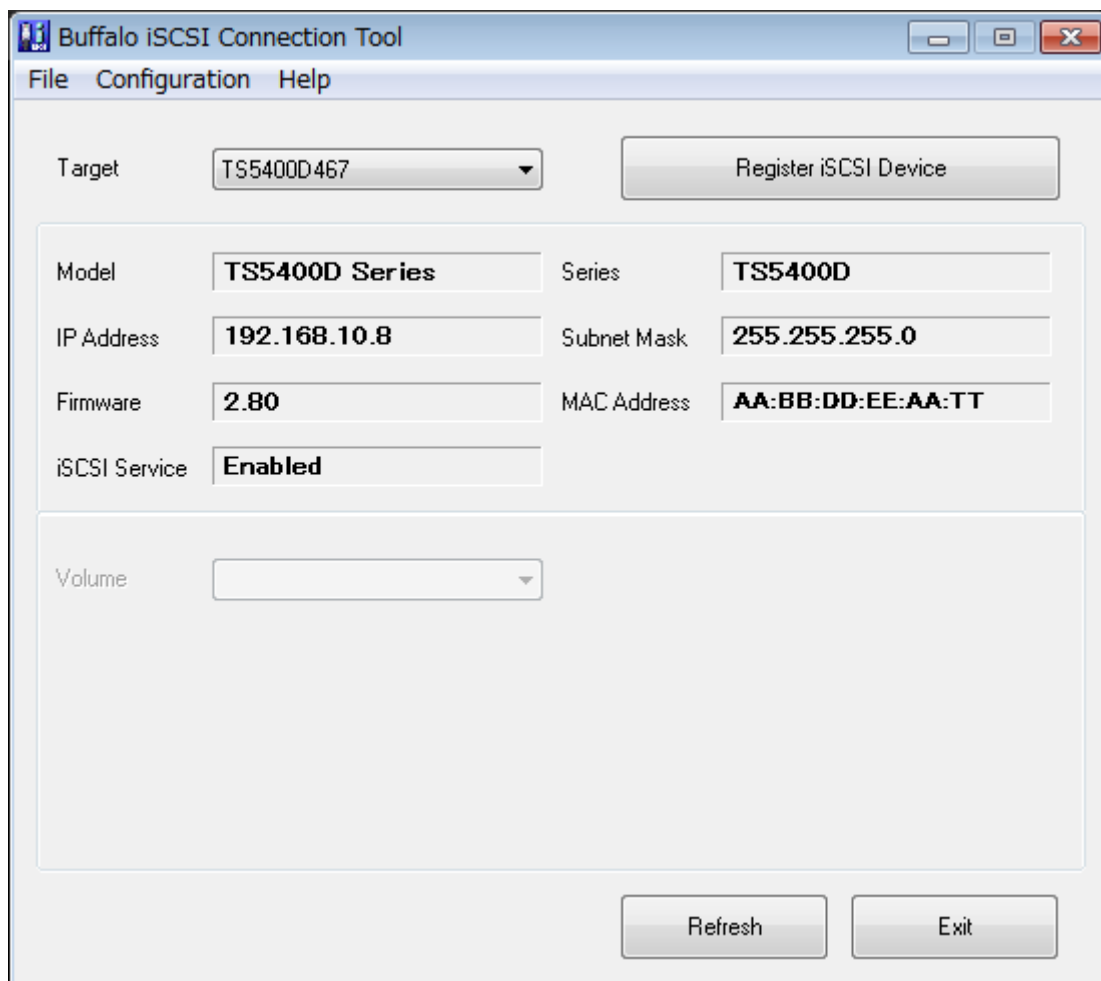

- 3 Select a volume to connect from the drop-down menu of "Volume" and click *Connect*.

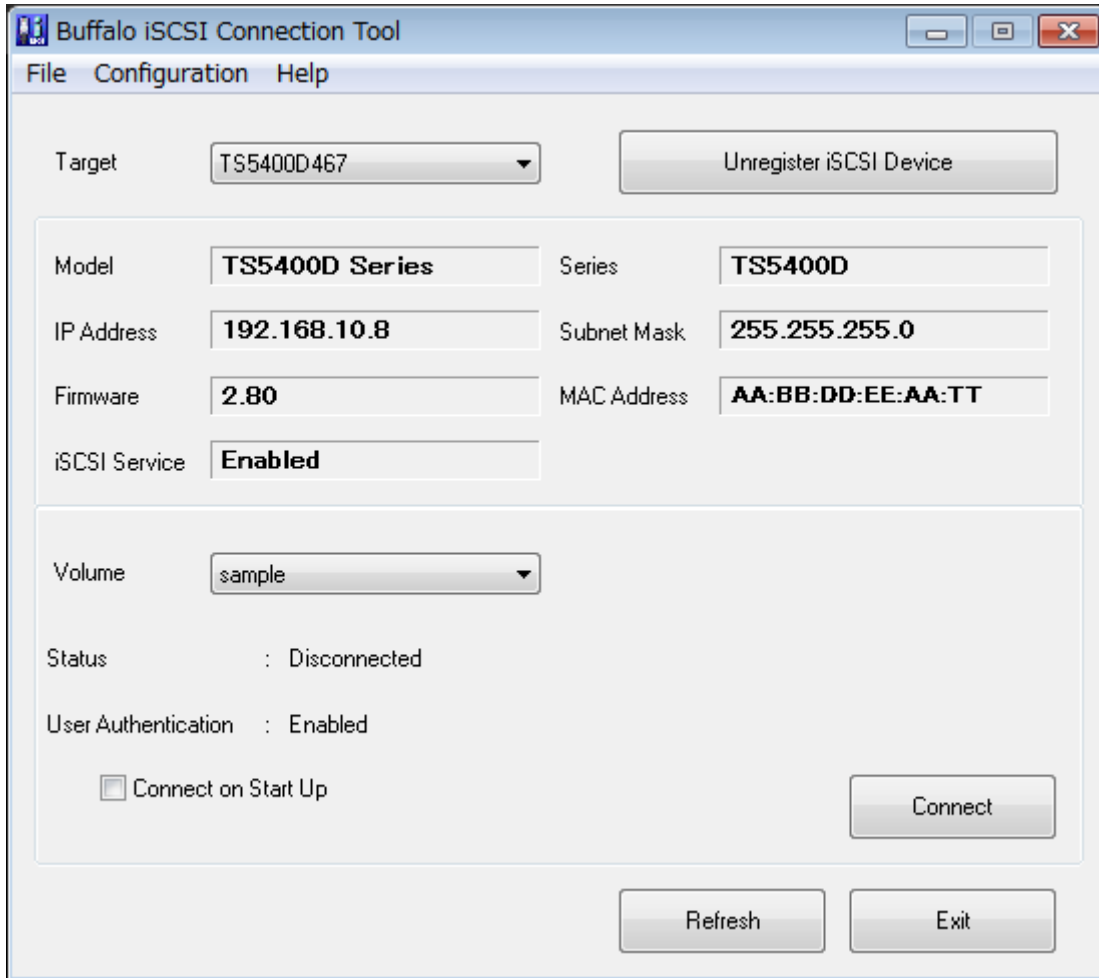

- 4 The screen to enter the username and password will be displayed. Enter the configured username and password from step 4 of the "Configuring Access Restrictions for Individual Volumes" section above and click *OK*.

If mutual authentication is enabled, check "Mutual Authentication", then click *OK*.



- 5** If "Mutual Authentication" is checked, the following screen will be displayed. Enter the mutual authentication password and click *OK*.

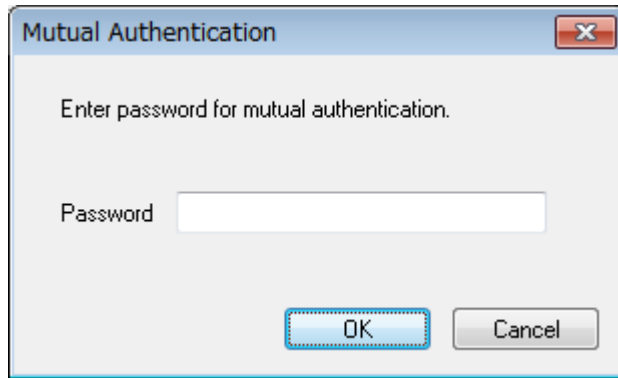

- 6** When authentication is successful, click *OK*.
Accessing the access-restricted volume is finished.

Expanding Volume Sizes

The volume size of the existing volumes can expand after they are created.

Notes:

- Expanding volume size may erase all data in the volume depending on the formatting type. Back up the data before expanding the volume size is recommended.
- To expand the volume size, the volume should be created in the LVM-enabled drive or array.

- 1** In Settings, click *Drives*.



- 2** Click  to the right of "iSCSI".

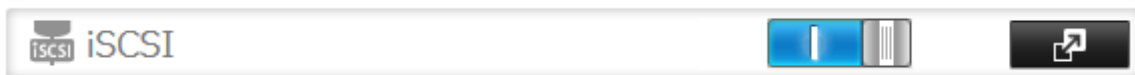

- 3** Select the volume to expand.

- 4 Enter the desired volume size to add and click *OK*.

Editing iSCSI Volume * Required ?

General

Volume Connection: Enable Disable

Volume Name: sample

Volume Description:

Volume: Array1 / 2762 GB

Size: 10 GB + GB = 10GB / Remaining 2752GB

IQN: iqn.2004-08.jp.buffalo.cc52afea8467.sample

Access Restrictions: Enable Disable

Client IQN:

Username * :

Password * :

Mutual Authentication: Enable Mutual Authentication

Mutual Authentication Password:

Advanced Settings OK Cancel

- 5 The "Confirm Operation" screen will open. Enter the confirmation number, then click *OK*.

- 6 Click *OK*, then *Close*.

Expanding the volume size is finished.

Deleting Volumes

To delete an existing volume, follow the procedure below.

Note: Deleting a volume will erase all data on the volume. Back up the data before deleting the volume.

- 1 In Settings, click *Drives*.



- 2 Click  to the right of "iSCSI".

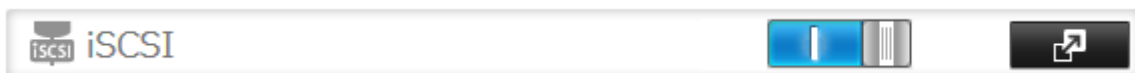

- 3** Select the volume to delete and click *Delete Volume*.

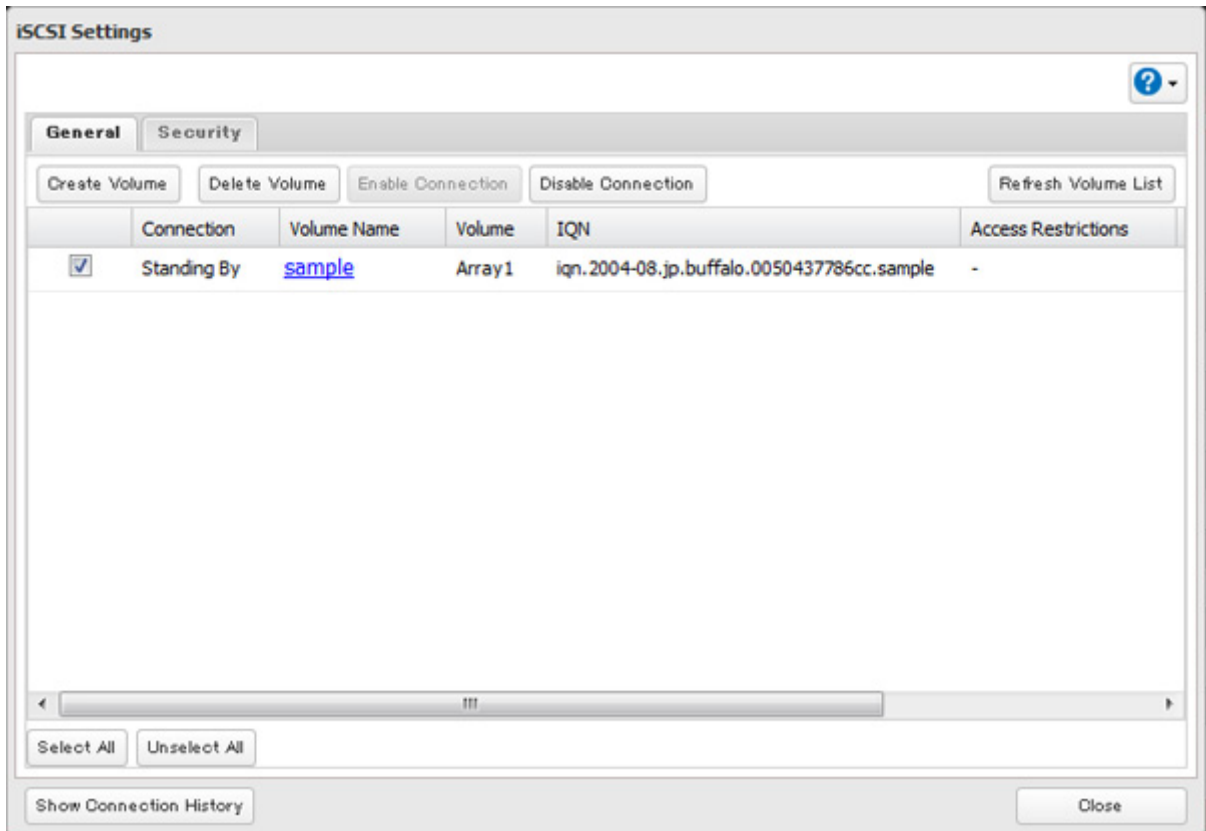

- 4** Confirm that the volume is correctly selected on the screen and click *OK*.
- 5** The "Confirm Operation" screen will open. Enter the confirmation number, then click *OK*.
- 6** Click *OK*.
- 7** Click *Close*.

Deleting the volume is finished.

Hard Drive Replacement

Hard drives in the TeraStation show a blue status LED during normal operation. If a drive fails, its error LED will glow red.

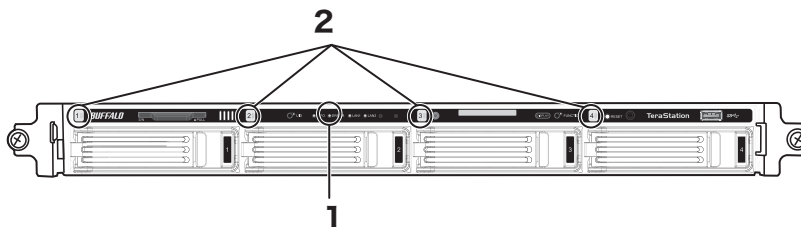
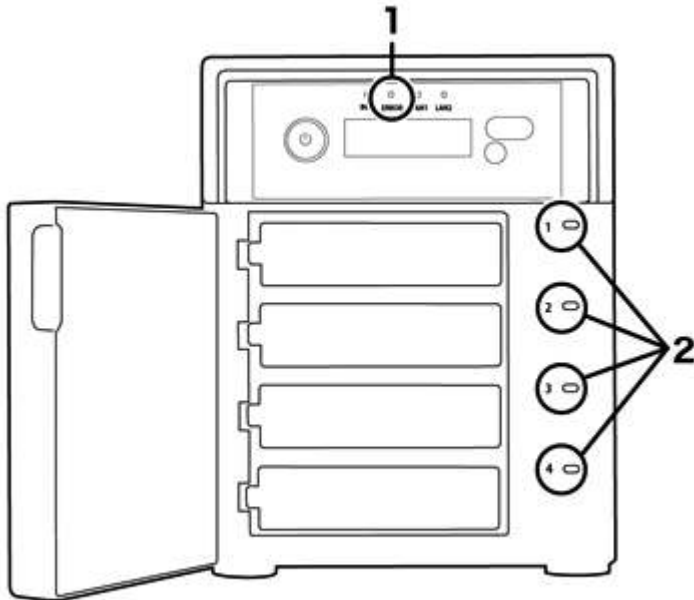

1 Error LED
Glow red if a drive has failed.

2 Status LEDs
The failed drive's status LED will be glowing a steady red. A drive with a red status LED is ready to hot-swap.

Notes:

- Do not unplug a drive whose status LED is green instead of red. Dismount it first or shut down the TeraStation before swapping a working drive. If you remove the drive without properly dismounting it, data may be lost or the TeraStation may malfunction.
- For the replacement drive, use a Buffalo OP-HDWR series drive for the TS5200DS, TS5000WR, and TS5000N series, a OP-HDH series drive for the TS5400RH, and a OP-HDS series drive for other TS5000 series TeraStations. The new drive should be the same size (or larger) as the replacement drive. If a larger drive is used, the extra space will not be usable in a RAID array.
- To avoid damaging the TeraStation with static electricity, ground yourself by touching something made of metal before handling any sensitive electronic parts.
- After a drive is replaced, it will take about 30 minutes before normal file reading and writing are restored. Settings may not be accessible during this period.

- Do not change the order of the hard drives in the TeraStation. For example, pulling out drive 1 and replacing it with drive 2 may cause data to be corrupted or lost.
- If the LCD display does not change after a new drive is installed, click *Rediscover Disk* in Settings.

Hard Drive Replacement Examples

Drive Replacement (using JBOD or a redundant RAID mode such as RAID 1, 5, or 6 with auto-shutdown disabled)

This section describes replacing a drive with **the TeraStation on**.

- 1 Open the front cover with the included key.

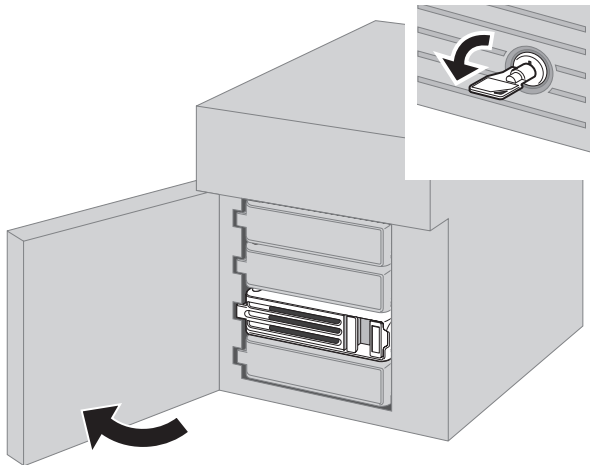

- 2 The failed drive's status LED will be glowing red. Push its unlock button and swing the lock mechanism out.

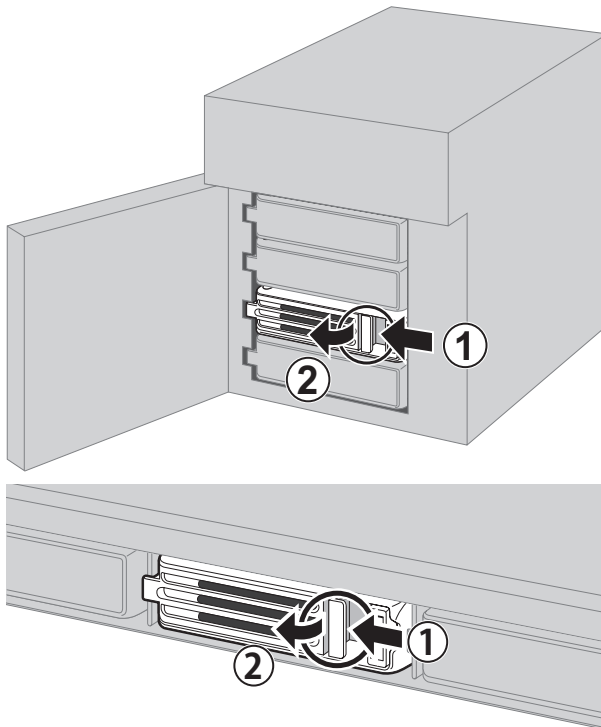

Hard drives without red status LEDs lit are still on. Do not unplug or remove them.

- 3** Pull out the drive cartridge and remove it from the TeraStation.

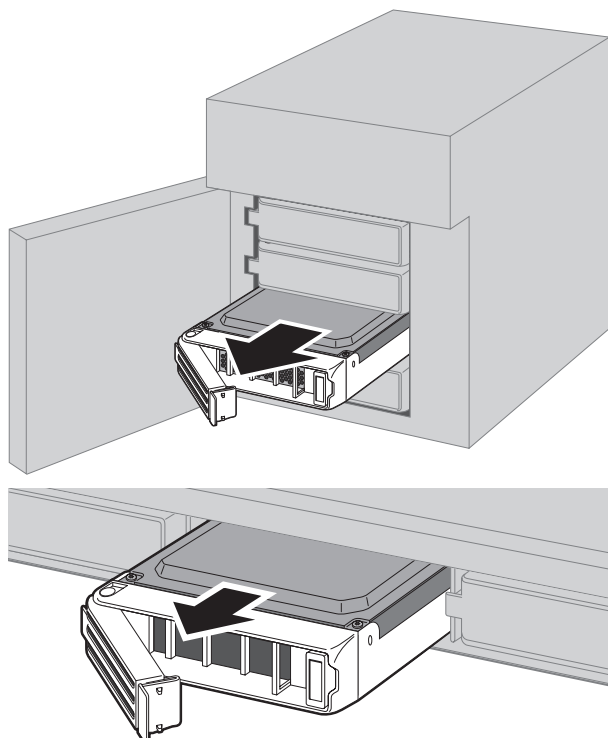

- 4** Insert the new drive into the empty slot. Slide the drive in with the locking mechanism open.

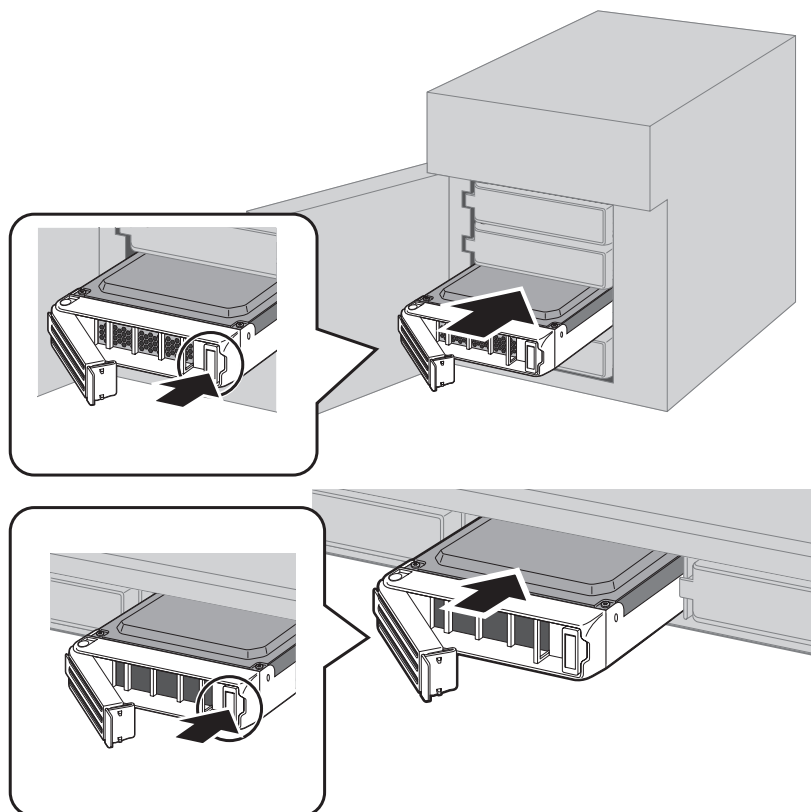

- 5** Swing the lock back down until it clicks into place.

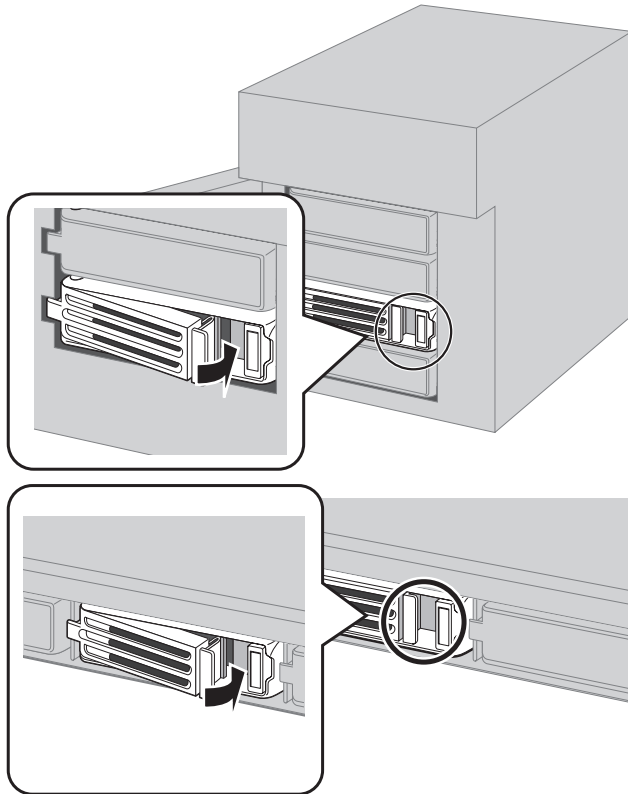

- 6** Close the front cover.

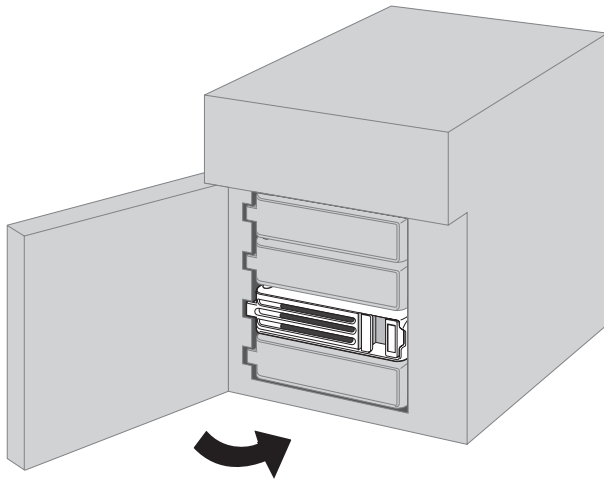

- 7** When the replacement hard drive is recognized, the status LED will flash red and the I31 message will be displayed on the LCD panel.

- 8** Hold down the function button on the front of the TeraStation for 3 seconds until it beeps.

For RAID 1, 5, or 6:

The TeraStation will start rebuilding the RAID array automatically. After a few minutes, the I18 message will be displayed until the array is rebuilt.

For RAID 51 or RAID 61:

The TeraStation will start rebuilding the RAID array automatically. After a few minutes, the I18 message will be displayed until the array is rebuilt.

If 3 or more drives were replaced in a RAID 51 array, or if 4 or more drives were replaced in a RAID 61 array, wait 10 minutes after I18 appears and navigate to *Drives - RAID* in Settings. Select the RAID array and check if "Recover RAID Array" button is displayed. If so, select the drives that were not included in the RAID array and click *Recover RAID Array*.

For JBOD:

The drive will be formatted as an individual drive. Create a shared folder on the drive before use.

Drive Replacement (using a redundant RAID mode such as RAID 1, 5, or 6 with auto-shutdown enabled)

This section describes the process of replacing a drive while **the TeraStation is off**.

- 1** Open the front cover with the key.
- 2** Push the unlock button of the failed hard drive and swing the lock mechanism out.
- 3** Pull out the drive cartridge and remove it from the TeraStation.
- 4** Insert the new hard drive into the empty slot. Slide the drive in with the locking mechanism open. Swing the lock back down until it clicks into place.
- 5** Close the front cover.
- 6** Press the power button on the TeraStation.
- 7** When the replacement hard drive is recognized, the status LED will flash red and the I31 information message will be displayed on the LCD panel.
- 8** Hold down the function button on the front of the TeraStation for 3 seconds until it beeps. The TeraStation will start rebuilding the RAID array automatically. It will take about 5 minutes before the I18 message is displayed.

For RAID 51 or RAID 61:

The TeraStation will start rebuilding the RAID array automatically. After a few minutes, the I18 message will be displayed until the array is rebuilt.

If 3 or more drives were replaced in a RAID 51 array, or if 4 or more drives were replaced in a RAID 61 array, wait 10 minutes after I18 appears and navigate to *Drives - RAID* in Settings. Select the RAID array and check if "Recover RAID Array" button is displayed. If so, select the drives that were not included in the RAID array and click *Recover RAID Array*.

Drive Replacement (RAID 0)

Drives in a RAID 0 array do not automatically turn off in the event of a malfunction. Before replacing the failed drive, either dismount the drive from Settings, or shut down the TeraStation.

This section describes the process of replacing a drive with **the TeraStation on**.

Note: If a hard drive malfunctions in RAID 0, all data on the RAID array will be lost. All of the settings for the shared folders (such as access restrictions) are erased after replacing a drive from a RAID 0 array.

- 1** Open the front cover with the included key.
- 2** In Settings, navigate to *Drives - Drives*.
- 3** Select the hard drive with the flashing status LED and click *Dismount Disk*.

Note: Once you reboot the TeraStation after the drive failed, the status LED will be back to normal flash (green). In such case, select "Unformatted" drive from the list and click *Dismount Disk*.

- 4** Enter the number that appears on the screen, then click *OK*.
- 5** The status LED will stop flashing and glow steadily.

- 6** Unlock the failed drive by pushing the unlock button and swinging the lock mechanism out.
- 7** Pull out the hard drive cartridge and remove it from the TeraStation.
- 8** Insert the new hard drive (sold separately) into the empty slot. Slide the drive in with the locking mechanism open. Swing the lock back down until it clicks into place.
- 9** Close the front cover.
- 10** When the replacement drive is recognized, the status LED will flash red and the I32 information message will be displayed on the LCD panel.
Select the RAID array from *Drives - RAID* in Settings and click *Delete RAID Array*. In *Drives - Drives*, click *Format Disk* to format the new drive. In *Drives - RAID*, choose the type of RAID array desired. Enter the confirmation number and click *OK*. Create a shared folder before use.

Drive Replacement (using a redundant RAID mode such as RAID 1, 5, or 6 with a hot spare configured)

If your TeraStation's drives are in a redundant RAID mode, and you have a hot spare enabled, a malfunctioning drive in the array is replaced by the spare disk and the RAID array is rebuilt automatically. The status LED will continue to glow red for the failed drive even after the RAID array is rebuilt with the hot spare. This section describes the replacement process for a hard drive while **the TeraStation is still on**.

- 1** Open the front cover with the included key.
- 2** The failed drive's status LED will be glowing red. Push its unlock button and swing the lock mechanism out.
- 3** Pull out the drive cartridge and remove it from the TeraStation.
- 4** Insert the new drive into the empty slot. Slide the drive in with the locking mechanism open. Swing the lock back down until it clicks into place.
- 5** Close the front cover.
- 6** When the replacement drive is recognized, the status LED will flash red and the I31 information message will be displayed on the LCD panel.
- 7** Hold down the function button on the front of the TeraStation for 3 seconds until it beeps. The replacement hard drive is automatically registered as a hot spare.
To use the replacement disk as a normal drive rather than a hot spare, navigate to *Drives - RAID* and click the RAID array, select the new drive, and click *Set as a normal disk*.

Replacing a Media Cartridge

Drives configured as media cartridges may be removed and moved to a different TeraStation for use. Before unplugging the drive, dismount it in Settings or shut down the TeraStation.

Chapter 5 Backup

Back Up from the TeraStation

You can back up TeraStation folders to:

- A different folder on the TeraStation
- Another LinkStation on the network
- Another TeraStation on the network

You can also configure backup jobs from Easy Admin.

Preparing a Backup Destination

First, configure a folder as a backup destination.

- 1 In Settings, click *File Sharing*.

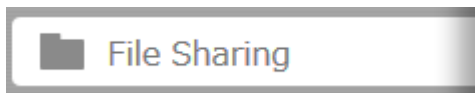

- 2 Click  to the right of "Folder Setup".

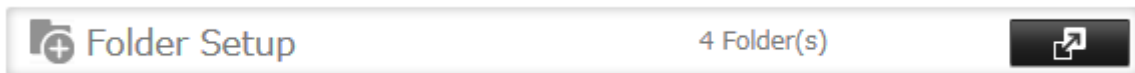

- 3 Choose the folder to set as a backup destination.
- 4 Click *Edit*.
- 5 Under "LAN Protocol Support", check "Backup" and click *OK*.

Note: To configure a password, enter it in the "Remote Backup Password" field. Leave this field blank if you don't want a password. If the target device is configured with a backup password, you can easily find the backup target folder during configuration of the backup job by searching for the password.

Backing up to a LinkStation or TeraStation on another network when connected by a VPN

You can back up to a LinkStation or TeraStation on another network as long as the two networks are connected by a VPN. Follow this procedure to enter the IP address or hostname of the target LinkStation or TeraStation.

- 1 In Settings, click *Backup*.



2 Click  to the right of "Backup".



3 Click *List of LinkStations and TeraStations*.

Backup List

Backup Password: ?

Filter:

Task	Scheduled	Day	Time	Operation Mode	Status
------	-----------	-----	------	----------------	--------

- 4** Click *Add* under "Off-subnet Devices", enter the IP address of the target LinkStation or TeraStation, and click *Close*.

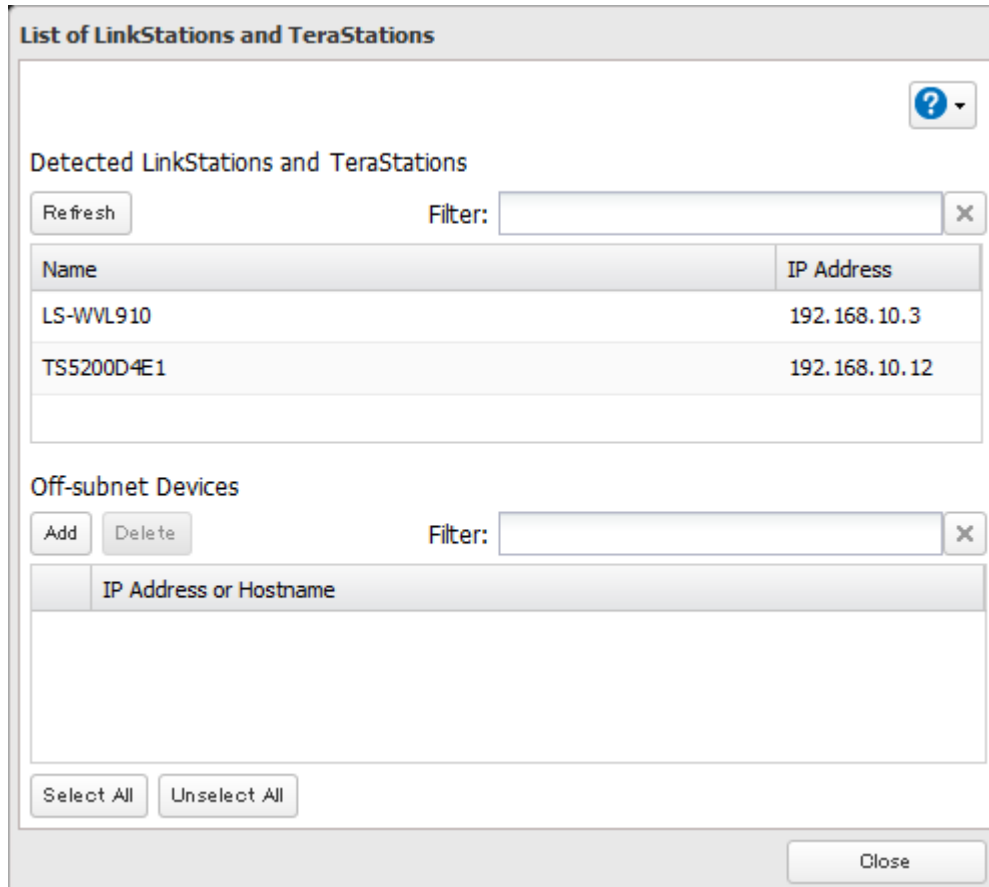

If your setup meets the requirements below, you don't have to configure these settings:

- The source and target TeraStations are on the same network.
- No backup password is set for the target TeraStation.
- No TeraStation from outside the subnet, or connected by a VPN, is used.

Notes:

- To back up data between LinkStations or TeraStations on a network using jumbo frames, make sure that both devices are configured to use identical (or similar) Ethernet frame sizes. If Ethernet frame sizes are significantly different, the backup job may not be properly performed. In such a case, select the default frame size (1500 bytes).
- You can also specify hostname by a fully qualified domain name (FQDN).
- Windows-based TeraStations with multibyte characters in the hostname may not be detected as a backup target, and folders in these devices cannot be used as backup target folders.

Configuring a Backup Job

- 1** In Settings, click *Backup*.



- 2** Click  to the right of "Backup".



3 Click *Create New Job*.

The screenshot shows a window titled "Backup List". At the top right is a help icon (question mark in a blue circle). Below it is a "Backup Password:" label with a "Set" button. Underneath is a text box containing "List of LinkStations and TeraStations". Below that are two buttons: "Create New Job" and "Delete Job(s)". To the right of these buttons is a "Filter:" label followed by an empty text box and a close button (X). Below this is a table with the following columns: "Task", "Scheduled", "Day", "Time", "Operation Mode", and "Status". The table body is empty. At the bottom left are two buttons: "Select All" and "Unselect All". At the bottom right is a "Close" button.

Task	Scheduled	Day	Time	Operation Mode	Status
------	-----------	-----	------	----------------	--------

Note: Up to 8 backup jobs can be configured.

4 Select backup settings such as date and time to run.

The following types of backup jobs may be selected:

Type	Files included
Normal backup	All files in the source will be backed up to the destination. You can specify how many backup versions to keep from 1–400, or select "Unlimited" to keep all backups until the drive is full. If a specific number of backup versions is specified, the backup destination folder should be on the same TeraStation that the backup job is configured from, or on an external USB drive attached to that TeraStation.
Overwrite (incremental)	The first time the backup job runs like a normal backup. In subsequent backups, files added to the source as well as files deleted from the source are kept in the backup folder.
Overwrite (differential)	The first backup job runs like a normal backup. As each additional backup job runs, files are added to and deleted from the backup folder. The backup destination folder is always the same size as the backup source folder.

Type	Files included
Management backup	<p>Each time a backup is executed, management information is stored, and only files that have changed are copied or deleted. Data is retrieved from the previous backup file for files that were not changed. This is useful for making backups with limited space or for referencing status at a particular point in time (for use for data snapshot applications). The destination folder for a management backup should be a local folder on this TeraStation or on a USB drive attached to it. The target folder will be set to read-only. Do not use folders from drives formatted with FAT.</p> <p>You can specify how many backup versions to keep from 1–400, or select "Unlimited" to keep all backups until the drive is full. If a specific number of backup versions is specified, the backup destination folder should be on the same TeraStation that the backup job is configured from, or on an external USB drive attached to that TeraStation.</p>

- 5** Click *Add*.
- 6** Click *Browse* under "Backup Source Folder Name".
- 7** Select the shared folder that will be the backup source, then click *OK*.

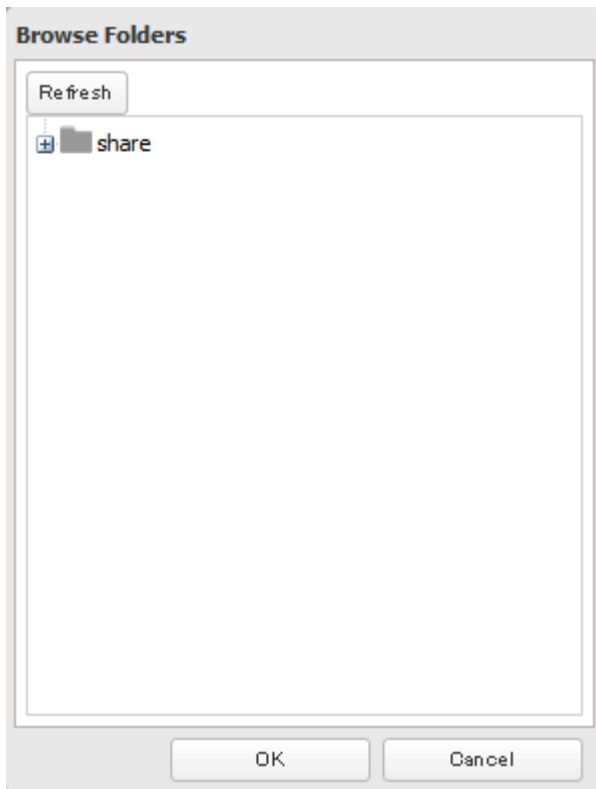

- 8** Click *Browse* under "Backup Target Folder Name".

- 9 Select the backup target and click *OK*.

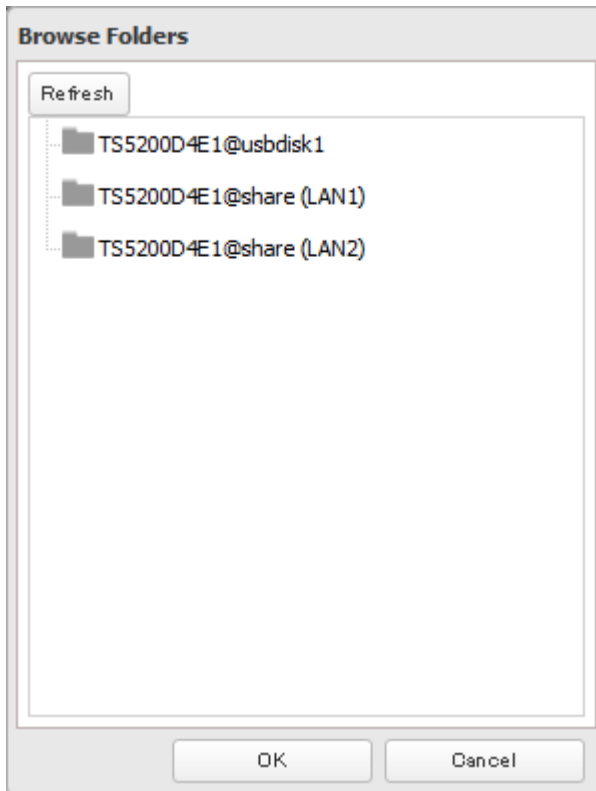

Note: Backup targets may include "(LAN1)" or "(LAN2)", indicating which LAN port will be used for the backup job.

- 10 Click *OK*. Tasks added to "Backup List" are displayed.

- 11 Click *Close*.

Replication

Replication copies all data from a share to a share on a different TeraStation. This is an easy way to configure a reliable system to provide data protection in the event your main TeraStation fails. To configure replication, connect an Ethernet cable to the LAN port of each TeraStation and follow the steps below.

Notes:

- For best results, use static IP addresses for both replication TeraStations (source and target).
- Replication source data is copied to the replication target folder with a differential overwrite. Any data that is not in the replication source will be overwritten.

Preparing a Replication Destination

First, configure a folder as a replication destination.

- 1 In Settings, click *File Sharing*.

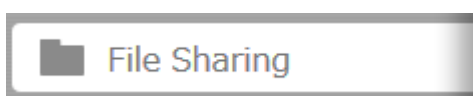

- 2 Click  to the right of "Folder Setup".

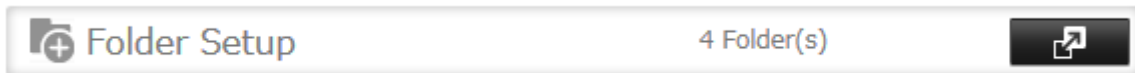

- 3 Choose the folder to set as a replication destination.
- 4 Click *Edit*.
- 5 Under "LAN Protocol Support", check "Backup" and click *OK*.

Note: Do not configure a backup password for the shared folders. Folders with a backup password set cannot be selected as replication targets.

Configuring a Replication Task

- 1 In Settings, click *Backup*.



- 2 Click  to the right of "Replication".

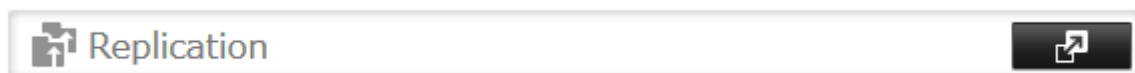

- 3 Click *Edit*.

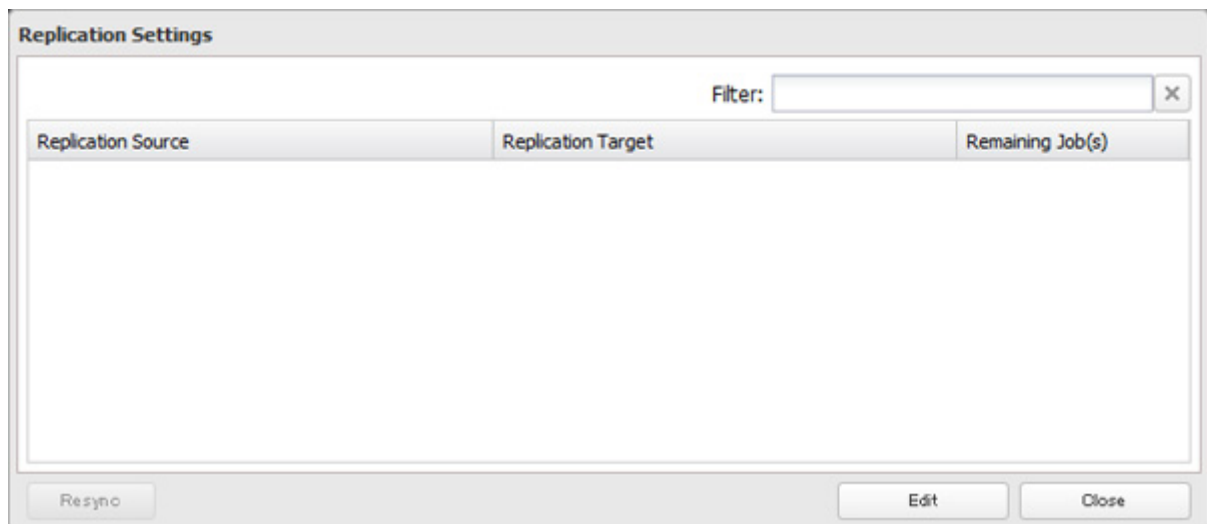

4 Click *Add*.

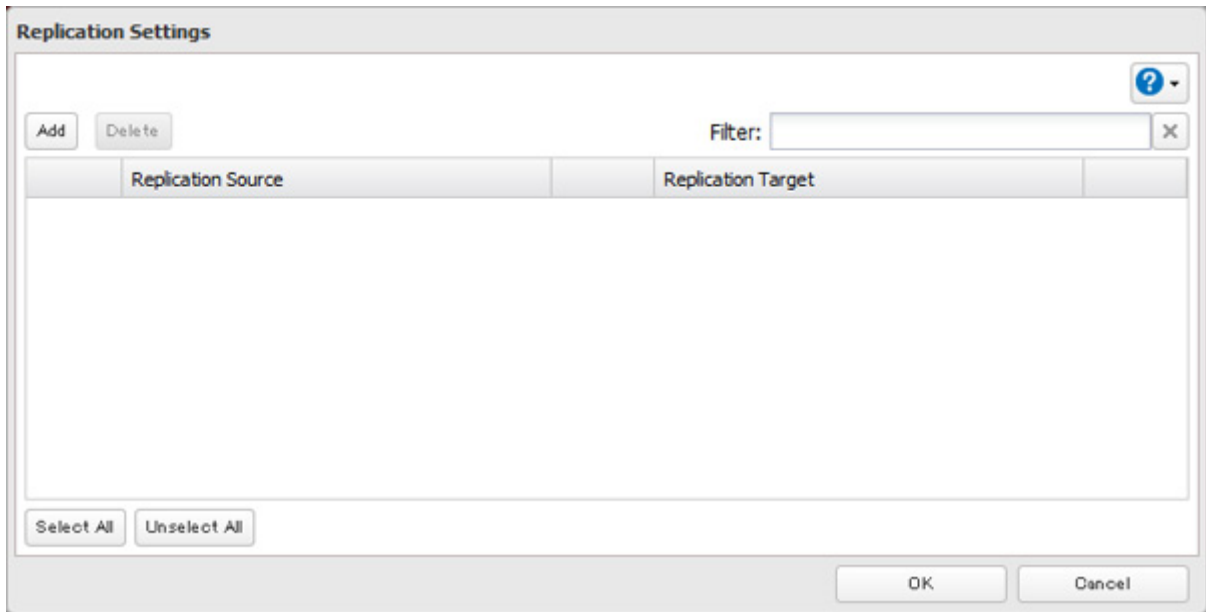

5 Click *Browse* under "Replication Source".

6 Select the shared folder that will be the replication source, then click *OK*.

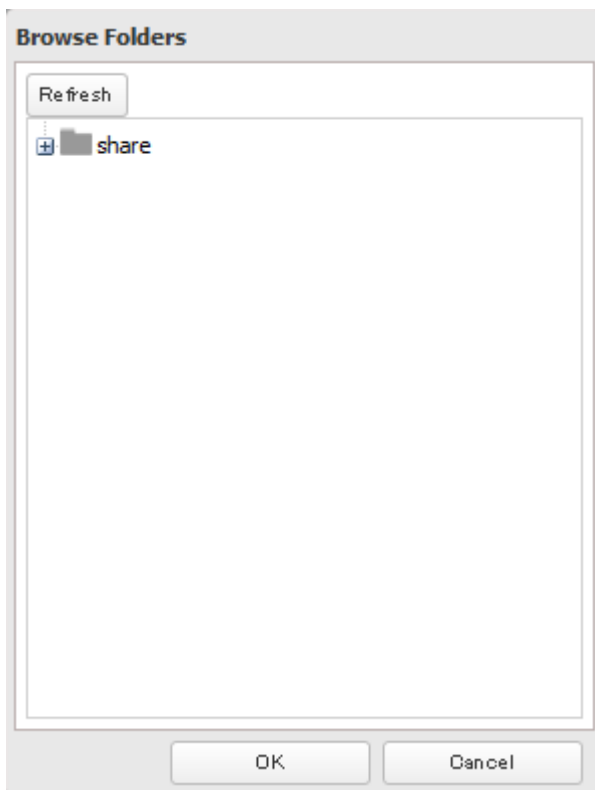

7 Click *Browse* under "Replication Target".

- 8** Select the shared folder that will be the replication target, then click *OK*.

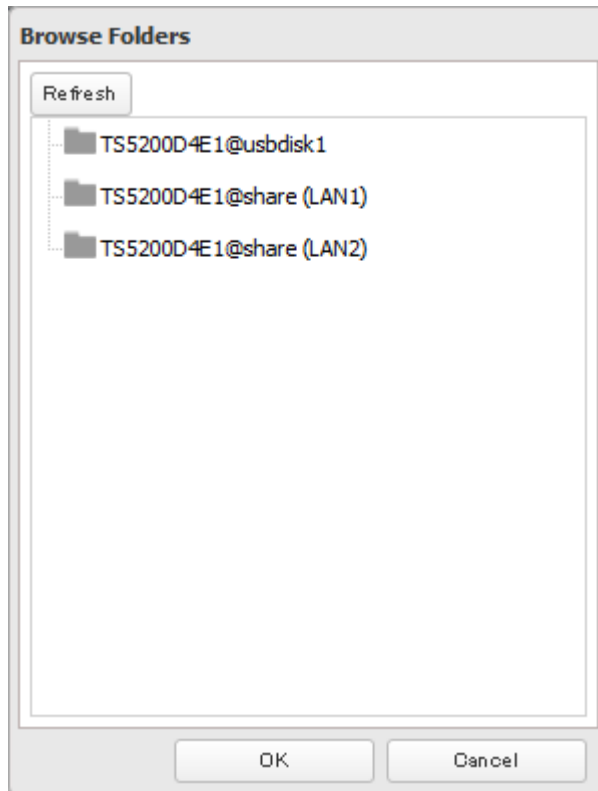

Note: Replication targets may include "(LAN1)" or "(LAN2)", indicating which LAN port will be used for the replication task.

- 9** Click *OK*.

- 10** Click *Yes*.

Notes:

- A maximum of 64 shared folders can be configured for replication.
- Replication can also be used to copy all data from a share to a share on an attached external drive. Format the drive with ext3 or XFS before using it for replication. Drives with FAT32 partitions are not supported with replication.
- You can select subfolders as the replication source. Folders whose names contain more than 80 alphanumeric characters cannot be selected.
- Don't use the same TeraStation for both failover and replication, or replication and Time Machine.
- Don't configure replication from one source folder to multiple target folders.
- If replication is configured via LAN port 2 and DHCP is used, the TeraStations may not automatically recover from network disconnection. If this happens, restart the TeraStations. For best results, give both replication TeraStations static IP addresses.

- If a network problem causes a replication error, unsynced data may be shown as "0" even though replication is incomplete. Click *Resync* to recover from the replication error. All files from the source folder will be copied to the target folder.

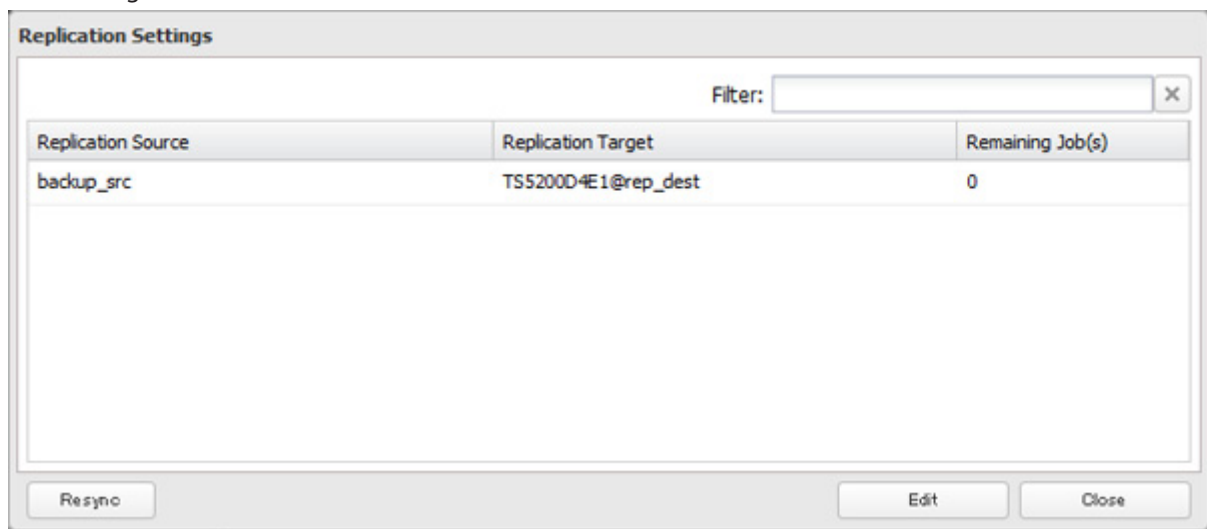

Failover

With failover, two TeraStations are connected to the network for redundancy. If a problem occurs in the main TeraStation so that it can no longer be accessed, operation is automatically switched to the backup TeraStation.

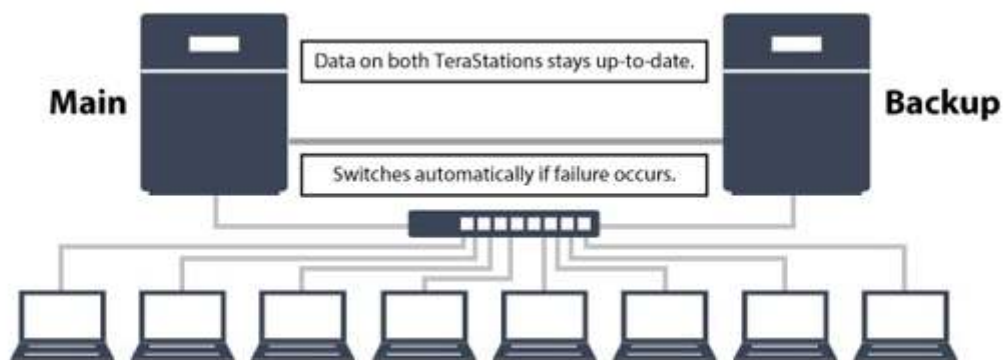

Notes:

- Use identical model and capacity TeraStations for the main TeraStation and backup TeraStation. If the capacity of the main TeraStation is larger than that of the backup TeraStation, an I33 error will occur.
- All drive bays of a TeraStation should be occupied if it will be used for failover. Failover will not work if a drive is missing from any bay.

Ethernet Cable Connection Methods

Two different configurations for failover are available.

Connecting to the network at LAN port 1 and setting failover at LAN port 1

With the first setup, if the main TeraStation fails, the backup TeraStation will replace it completely, using the same name and IP address. The backup TeraStation is updated over normal network traffic.

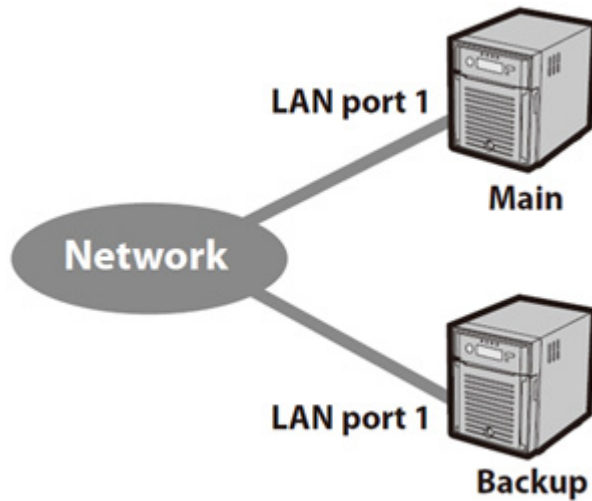

Connecting to the network at LAN port 1 and setting failover at LAN port 2

With the second setup, the backup TeraStation and main TeraStation are connected by a second Ethernet cable connecting their LAN 2 ports. Updating is done over this dedicated network path, so updates are quicker and don't interfere with normal network traffic. With this setup, if the main TeraStation fails, the backup TeraStation will replace it by name, but will keep its original IP address.

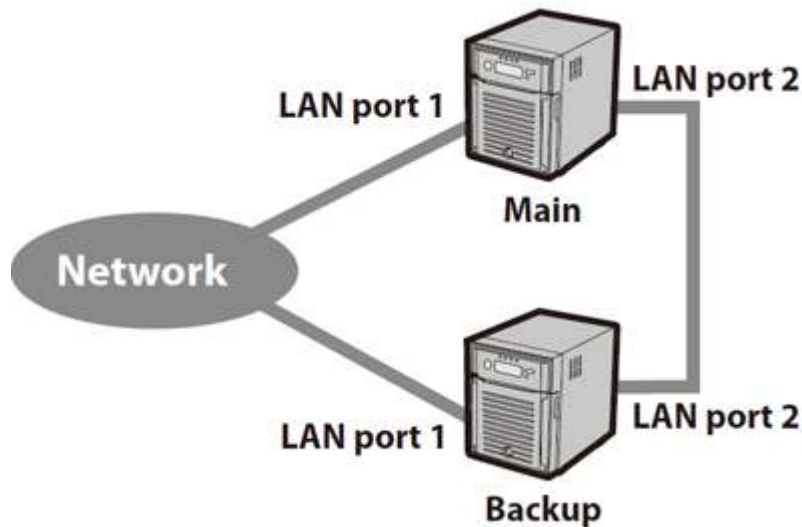

Check if the main TeraStation is alive using LAN port 1 and back up data via LAN port 2

- Select LAN port 1 for the backup target and LAN port 2 for the backup LAN port.
- This is more efficient than the setup below and doesn't interfere with normal network traffic.

Check if the main TeraStation is alive and back up the data via LAN port 2

- Select LAN port 2 for the backup target and for the backup LAN port.
- This is fault-tolerant if network disconnections occur.

The main and backup TeraStations should be the same model and capacity. Use fixed IP addresses for both TeraStations. Because the IP address of the TeraStation designated as the backup cannot be changed, set its IP address before configuring failover.

Usage Restrictions

Function Restrictions

Failover is not available when any of the following functions are enabled:

Replication, sleep mode, encrypted disk volume, MySQL server, media cartridge, LVM volume, iSCSI volume, port trunking, cloud storage, surveillance server, hot spare, access restrictions by Active Directory or NT domain

The following operations will not be available while failover is enabled:

Initializing settings, changing the RAID settings, formatting drives, iSCSI volume, changing the backup unit's settings

Non-Transferable Settings

The settings below are not copied from the main TeraStation to the backup TeraStation. Make a note of the original settings so that they can be configured manually if the backup TeraStation replaces the main TeraStation.

Web server (including PHP), MySQL server, Direct Copy, WebAccess, print server, UPS synchronization, antivirus*

*Only if the antivirus is activated on the TeraStation.

Using with UPS

Once failover is configured, you cannot set up a UPS for the backup TeraStation. Configure your UPS before configuring failover. UPS recovery can be configured for both the main TeraStation and the backup TeraStation. However, the UPS settings of the main TeraStation will not be copied to the backup TeraStation.

If the backup TeraStation is configured to sync with the UPS connected to the main TeraStation, and the main TeraStation shuts down, the backup TeraStation will no longer be able to detect if there was a power outage. In this case, move the UPS communication cable from the main TeraStation to the backup TeraStation and reconfigure the UPS link settings.

Configuration

- 1 In Settings, click *Backup*.

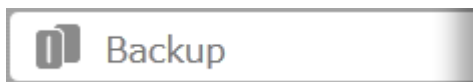

- 2 Click  to the right of "Failover".



- 3 Click *Edit Failover Status*.

4 Select a TeraStation to be the target backup device.

Failover Settings

Status: Standalone

Registered Backup Device: TS5200D4E1/192.168.10.34 (LAN 1)

Backup LAN Port: LAN 1 LAN 2

Admin Password of the Failover Target:

Use TeraStations of the same model and storage capacity for the main and backup units.
Set the Ethernet frame size to 1500 bytes for both units.

Continue Close

Note: The target TeraStation's hostname, IP address, and LAN port number will be shown. The LAN port selected here will be used to check the main TeraStation for continued operation.

5 Enter the administrator password of the target backup device, then click *Continue*.

6 If the administrator password is correct, the backup TeraStation will beep. To accept the settings from the main TeraStation, hold down the function button on the front of the backup TeraStation until it stops beeping.

7 The I51 message will display on the LCD and NAS Navigator2 for both TeraStations. Wait until initialization finishes. Failover is configured after it finishes and the I51 message disappears.

Notes:

- If replication is configured for more than one folder, initialize the TeraStation before configuring failover.
- The main TeraStation cannot be used as the backup location for Time Machine.
- If email notification is enabled and failover occurs, navigate to *Management - Email Notification - Edit* in the main TeraStation's settings and click *OK*.
- Ethernet frame size settings for main and failover TeraStations should be 1500 bytes. To change the Ethernet frame size, navigate to *Network - IP Address*, click the LAN port and *Edit*, and change the Ethernet frame size to "1500" bytes.
- Files whose filenames contain more than 80 alphanumeric characters will not be backed up.
- If the I33 error message appears on the LCD display, navigate to *Backup - Replication* and click *Resync*.
- Don't use the same TeraStation for both failover and replication, or failover and Time Machine.

Additional Settings

Maintenance Mode

If failover is configured, enable maintenance mode temporarily before turning off the TeraStation or updating the TeraStation's firmware.

Enable/Disable Maintenance Mode

Maintenance mode can be enabled and disabled at *Backup - Failover* in the main TeraStation's settings. Click *Maintenance mode* to enable maintenance mode, or click *Cancel maintenance mode* to disable maintenance mode.

Service IP Address

The "service IP address" will be the new address of the backup TeraStation when it takes over operation from the main TeraStation. If no service IP address is set, or a fixed IP address is set, an attempt is made to inherit the IP address from the main TeraStation.

When the Main TeraStation Fails

Backup TeraStation Promotion Situations

- **The backup TeraStation cannot detect the main TeraStation within a specified time**
If the backup TeraStation has not received the packet from the main TeraStation for a specified time, the backup TeraStation considers the main TeraStation to have failed. By default, it will try 5 times and wait 60 seconds. If this is triggered by accident, reconfigure failover from the main TeraStation.
- **The following error occurs**
If any of the following errors occur, the main TeraStation will automatically shut down and the backup TeraStation will take over from the main TeraStation:
E12 (cooling failure), E14 (cannot mount RAID array), E16 (drive not found), E22 (cannot mount drive), E30 (drive failure)
Note: The main TeraStation will shut down automatically when any of the above errors occur.

Displayed Messages

If network problems occur, the following messages may appear on the LCD display and in NAS Navigator2 even if neither TeraStation has failed. If this happens, log in to both the main and backup TeraStation's Settings, reset the failover settings, and configure it again.

- The I49 message may appear for the backup TeraStation if the main TeraStation fails.
- The E27 message may appear for the main TeraStation if it cannot detect the backup TeraStation on the network.

Switching to the Backup Unit Manually

If "Switch to backup unit manually" is selected in Settings, the backup TeraStation will not replace the main TeraStation automatically. If the main TeraStation fails, there are two ways to have the backup unit replace the main unit manually on the network:

- In Settings, click on the "Set as Main Unit" button.
- Or, press and hold down the function button on the backup TeraStation.

Backing Up Your Mac with Time Machine

Time Machine is a backup program included with OS X 10.5 or later. Configure your TeraStation as shown to use Time Machine.

- 1 In Settings, click *File Sharing*.

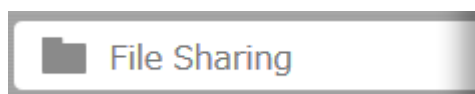

2 Move the AFP switch to the  position to enable AFP.



3 Click  to the right of "Folder Setup".



4 Choose a shared folder as your backup destination for Time Machine.

5 Click *Edit*.

6 Under "LAN Protocol Support", check "AFP (Mac)" and click *OK*.

7 Click *OK*.

8 Click *Close*.

9 Click *Backup*.



10 Click  to the right of "Time Machine".



11 Click *Edit*.

12 Click *Browse*.

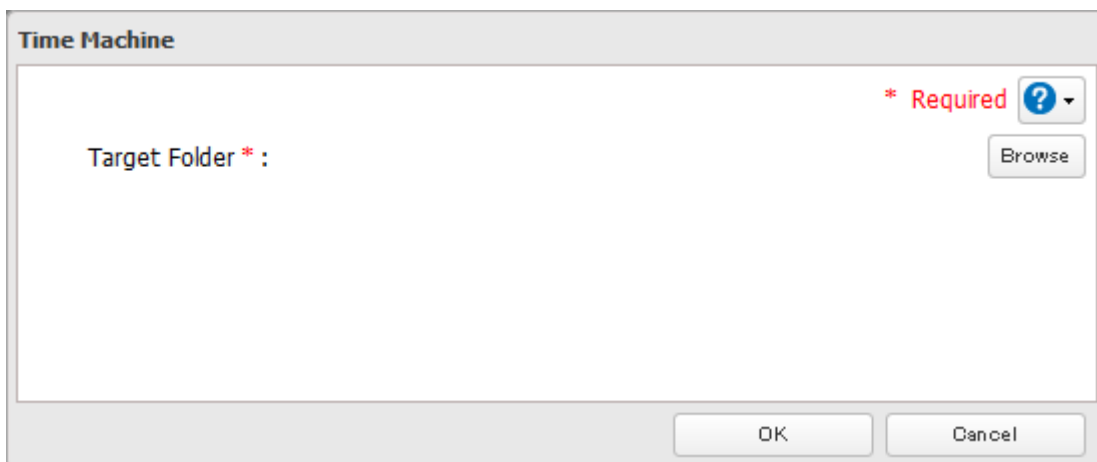

13 Select the shared folder that you set in the previous step, then click *OK*.

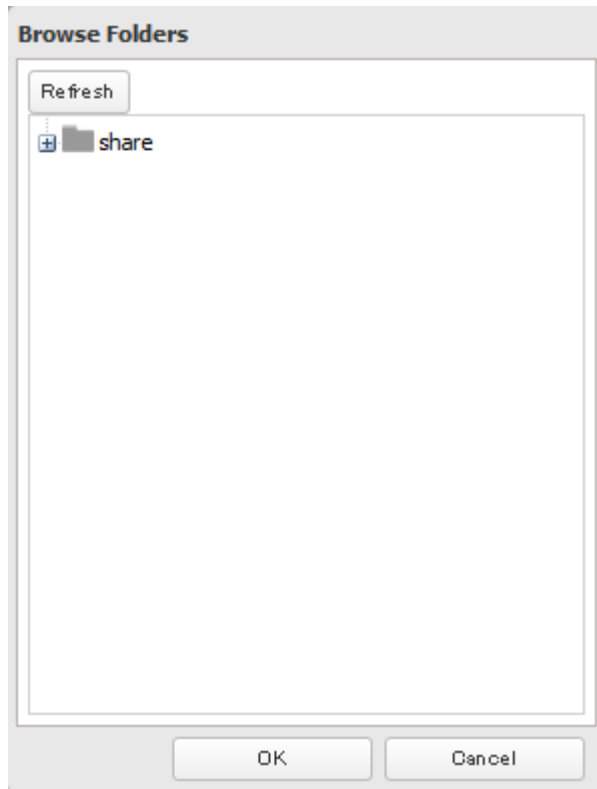

14 Click *OK*.

15 Click *OK*.

16 Move the Time Machine switch to the  position to enable Time Machine.

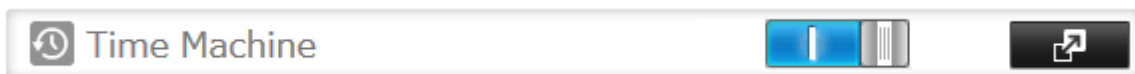

17 On the Mac, open *System Preferences*.

18 Click *Time Machine*.



19 Click *Select Backup Disk*.



20 Select the TeraStation, then click *Use Disk*.

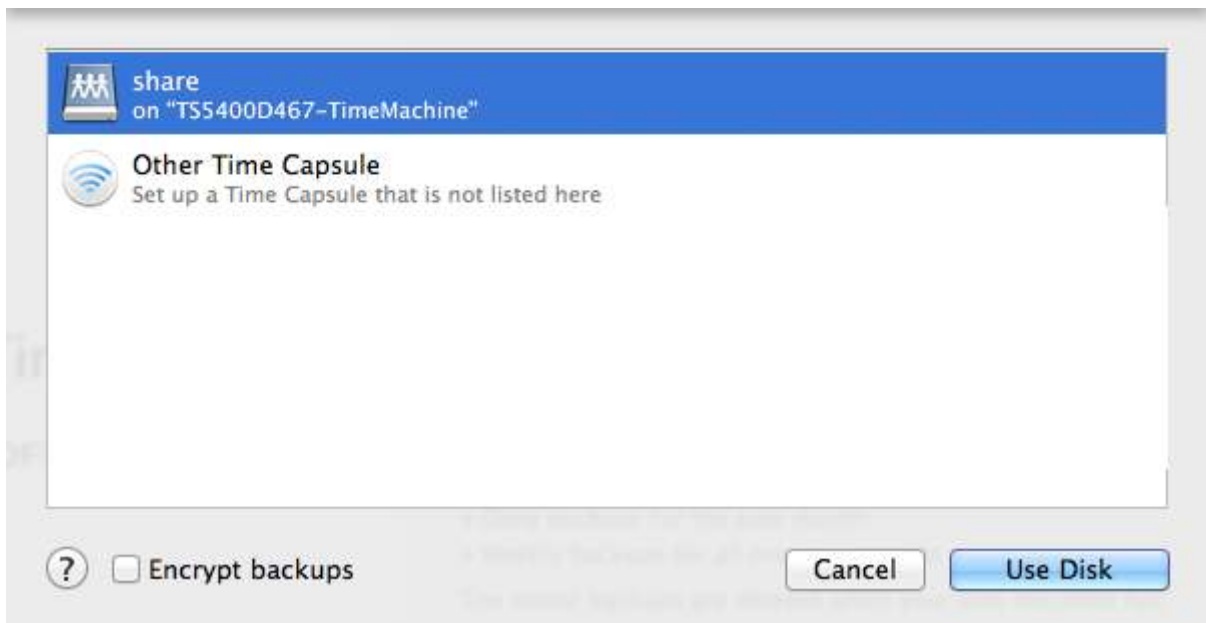

- 21** Enter a username and password with the rights to access the shared folder of the TeraStation, then click *Connect*.

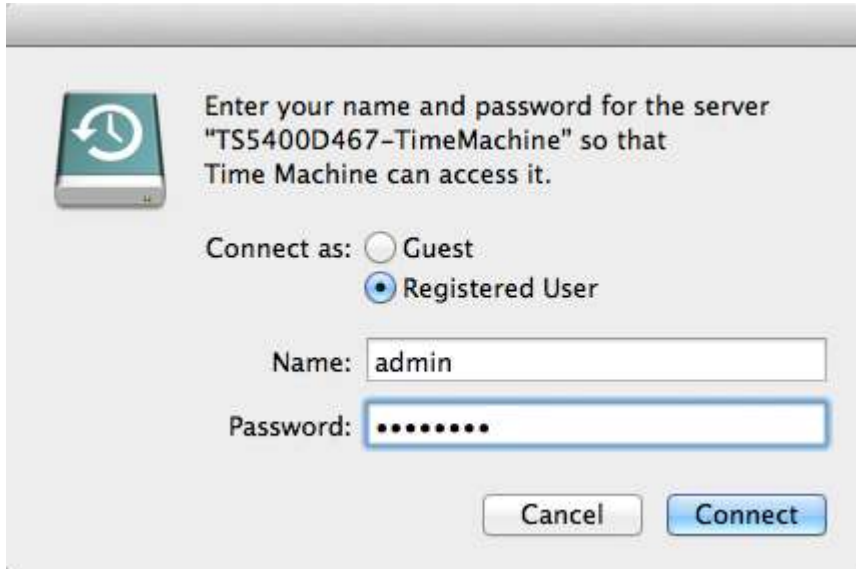

Note: If access restrictions are not configured on the target share, log in with the administrator account. The default username and password for the administrator account are "admin" and "password". If access restrictions are configured, log in with an account with write privileges.

- 22** Time Machine will count down from 120 seconds, and the backup will begin.



Copying from a USB Device

Use Direct Copy to copy from a USB device directly to the TeraStation.

Note: To use Direct Copy, connect only one USB device at a time.

These devices are supported:

- USB mass storage devices
- Card readers (except for card readers that can recognize two or more memory cards)
- Digital cameras and other PTP devices
- UPS devices that are specifically indicated as compatible
- USB printers

These devices are not supported:

- USB hubs
- Mice
- Keyboards

1 In Settings, click *Backup*.



2 Move the Direct Copy switch to the  position to enable Direct Copy.



3 Connect the USB device. When it mounts (about 10 seconds), the function button will light up.

Note: Devices that don't trigger the function button to flash are not supported.

4 You have 60 seconds to hold down the function button for 3 seconds. This will copy all files from the USB device to the Direct Copy folder of the TeraStation.

Notes:

- While the function button is flashing, press and release it quickly to cancel Direct Copy. For digital cameras that are not in the USB mass storage class, all files in the digital camera are copied.
- To change the Direct Copy target folder, navigate to *Backup - Direct Copy - Edit*, select a new folder, and click *OK*.

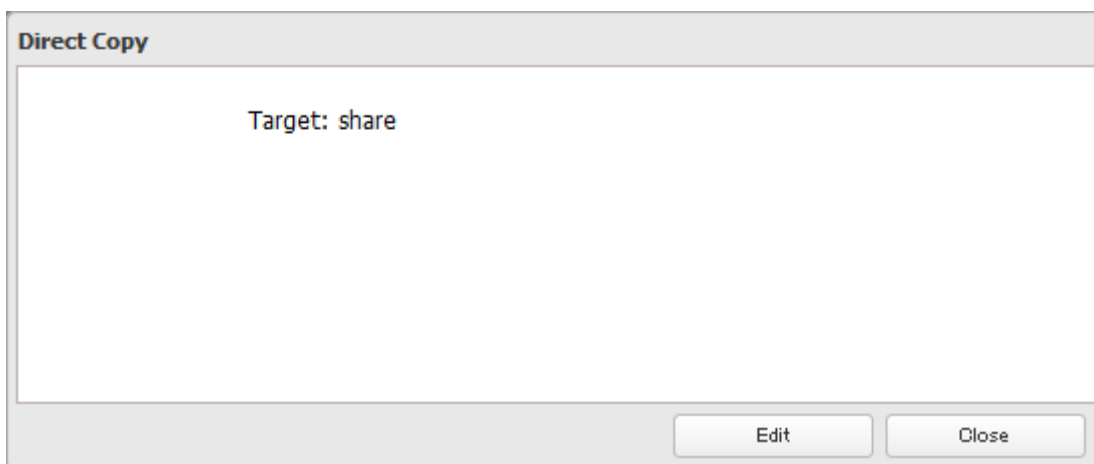

5 When the copy operation is finished, the access LED of the USB device will stop flashing. Hold down the function button for 6 seconds to dismount the device. The blue LED will go out and the device may be removed safely.

Chapter 6 Remote Access

WebAccess

WebAccess is a software program for accessing the files in the shared folder of your TeraStation from your computer or mobile devices through the Internet. **Be careful when configuring WebAccess. Certain settings can make the files in the shared folder available to anyone on the Internet, without any access restrictions.**

Notes:

- You can also configure WebAccess from Easy Admin.

1 In Settings, click *File Sharing*.

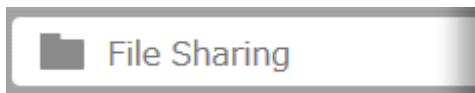

2 Click  to the right of "WebAccess".

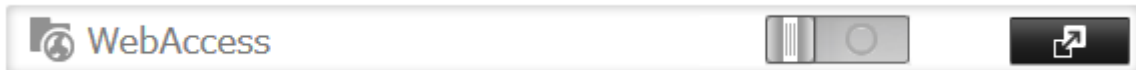

3 Click *Edit*.

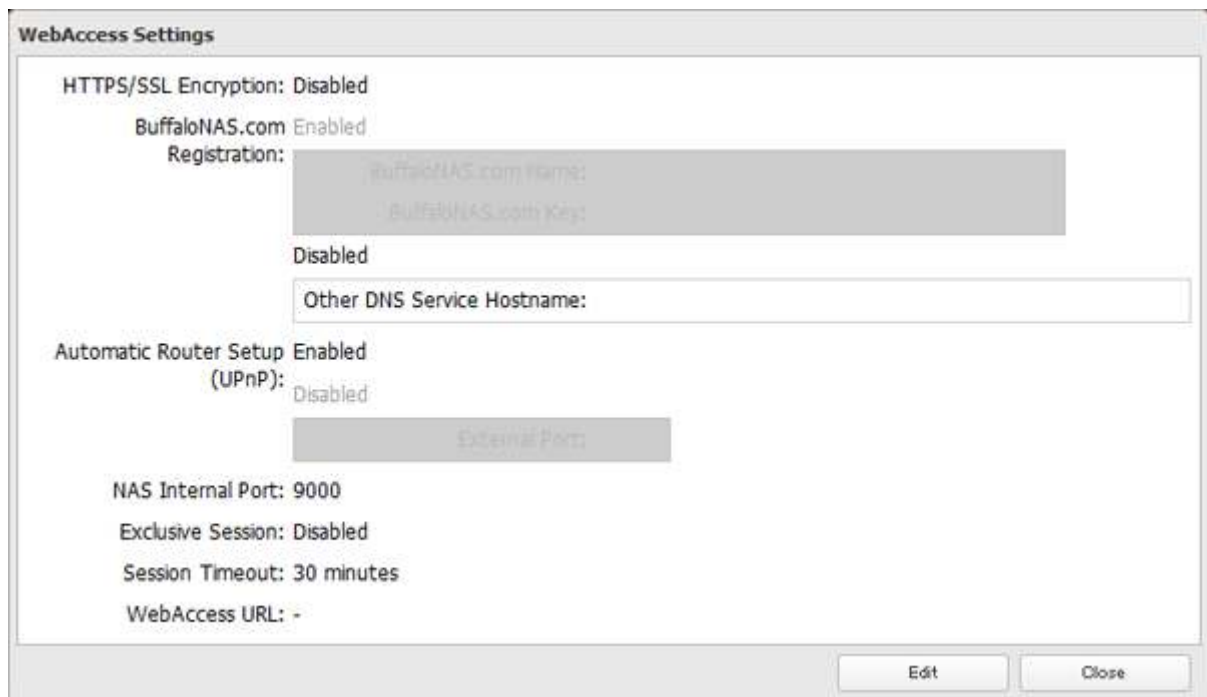

4 Configure the desired settings, then click *OK*.

- You may use the default BuffaloNAS.com registration, or disable to use a different DNS server.
- Choose a "BuffaloNAS.com Name" and "BuffaloNAS.com Key" for your WebAccess account. Names and keys may use 3 to 20 alphanumeric characters, underscores (_), and hyphens (-).
- If "Exclusive Session" is enabled, users cannot log multiple computers into WebAccess. Only the last login will be active.
- Enter a time in minutes (1 to 120, or "Unlimited") before inactive users are logged out of WebAccess.

5 Click *OK*.

6 Move the WebAccess switch to the  position to enable WebAccess.

7 Click  to the right of "Folder Setup".

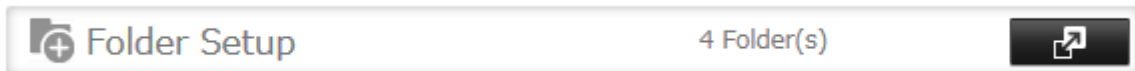

8 Select a shared folder to publish.

Notes:

- For best results, create a new dedicated share for WebAccess.
- When accessing shared folders through WebAccess from a remote location, a username and password may be required for certain operations. For best results, create a user account with permissions on the WebAccess share before using WebAccess.

9 Click *Edit*.

10 Under "LAN Protocol Support", check "WebAccess" and click *OK*.

Notes:

- The following levels of security are available:
 "Allow Anonymous" - Anyone can access (view) shared folders.
 "Allow All Groups and Users" - All groups and users registered on the LinkStation or TeraStation can use WebAccess.
 "Use Inherited Folder Permissions" - Users and groups have the same access permissions with WebAccess that they do locally. If access restrictions are not set for the shared folder, then this option will not be shown.
- When a user or group can access a folder through WebAccess depends on a combination of WebAccess settings and the shared folder's settings.

Folder Setup	WebAccess Public Mode	Allow Anonymous		Allow All Groups and Users		Use Inherited Folder Permissions	
	Folder Attribute	Read & Write	Read Only	Read & Write	Read Only	Read & Write	Read Only
WebAccess Account	Not logged in	R	R	-	-	-	-
	User with read & write access	R/W	R	R/W	R	R/W	R
	User with read-only access	R/W	R	R/W	R	R	R
	Group with read & write access	R/W	R	R/W	R	R/W	R
	Group with read-only access	R/W	R	R/W	R	R	R
	Other users	R/W	R	R/W	R	-	-

R: Read only, R/W: Read and write, -: No access

There are many ways to access WebAccess folders depending on your device.

- From a computer, supported browsers include Internet Explorer 8, Firefox 3.6, and Safari 4.
 Instructions: <http://buffalonas.com/manual/en/>
 Use compatibility mode to use WebAccess with Windows 8.1 and Windows 8 in desktop mode.
- To access from an iOS device, install the "WebAccess i" application from the App Store.
 Instructions: <http://buffalonas.com/manual/i/en/>
- To access from an Android device, install the "WebAccess A" application from Google Play.
 Instructions: <http://buffalonas.com/manual/a/en/>
- To access from a Windows Phone, install "WebAccess" from the Windows Phone Store.
 Instructions: <http://buffalonas.com/manual/wp/en/>

WebAccess Remote

WebAccess Remote lets you open a shared folder on a remote TeraStation or LinkStation from Explorer, My Computer, or other file manager.

To use WebAccess Remote, the following conditions must be satisfied.

- You have TeraStations or LinkStations in two different locations, such as at home and at a remote location.
- WebAccess should be enabled on the source TeraStation.

Note: Set the TeraStation's time settings to the correct time. Using NTP is recommended. To configure NTP settings on the TeraStation, refer to the "Name, Date, Time, and Language" section in chapter 10.

1 In Settings, click *Web Services*.



2 Click  to the right of "WebAccess Remote".

3 Click *Edit*.

- 4 From *Target Folder*, select the shared folder that will be connected.

WebAccess Remote Settings

* Required ?

Target Folder * : share

Type of Connection: Use BuffaloNAS.com name Use external DNS/IP address

BuffaloNAS.com Name * : johntest03

External DNS/IP Address * :

Remote NAS's Username * : admin

Remote NAS's Password * : ●●●●●●

Proxy Server: Enable Disable

Server Name * :

Port Number * :

Username * :

Password * :

Note: The selected folder is used internally by "WebAccess Remote". Files are not added to this folder and the amount of used space does not increase.

- 5 You may choose to enter a BuffaloNAS.com name or an external DNS/IP address. If using a BuffaloNAS.com name, it should be the same BuffaloNAS.com name assigned to the source TeraStation. If using an external DNS/IP address, enter either the IP address of your DNS server, or the global IP address of the remote TeraStation's WebAccess.
- 6 Enter the remote TeraStation's WebAccess username and password.
- 7 Click *OK*.
- 8 Move the WebAccess Remote switch to the  position to enable WebAccess Remote.
- 9 You can directly access the shared folder in the remote TeraStation by entering the path displayed in "Target Folder" into the address box in Explorer, My Computer, or other file manager.

Notes:

- If using after the network has been temporarily disconnected, click *Remount*.
- Do not change any WebAccess Remote settings while the network is disconnected. If you do, WebAccess Remote will be disabled.
- Do not copy more than 100,000 files at once to the WebAccess Remote target folder. If copying fails, try again with fewer files.
- Be careful with existing files in the target folder, as files with the same name will be overwritten even if copied files are older.
- If you copy a file to the WebAccess Remote source folder using Explorer or a backup process, the file will also be copied sequentially to the WebAccess Remote target folder. This second copying process will start in the background during the first copying process and will not be visible. If you shut down or restart the TeraStation immediately after copying a file to the source folder, the file may not be copied to the target folder. Try copying the file again if this occurs.
- If saving 1 TB or more files to or from the WebAccess Remote target folder, make sure there is enough free space on the WebAccess Remote source TeraStation for temporary file caching. For example, when saving

1 TB of files to the WebAccess Remote target folder, it is recommended to keep at least 2 TB of free space available.

FTP

By default, the TeraStation's shares are only accessible by users connected to the same network or router as the TeraStation. The optional FTP server allows users outside the local network to access the TeraStation.

Note: FTP is intended for users who already have FTP client software and have experience with it.

- 1** In Settings, move the FTP switch to the  position to enable FTP.



- 2** Click  to the right of "Folder Setup".

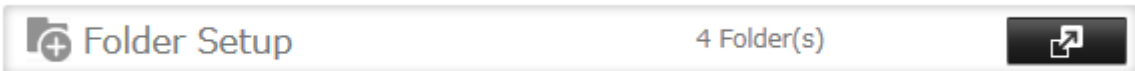

- 3** Choose a folder to enable remote FTP access on.

- 4** Click *Edit*.

- 5** Select read-only or read & write for the shared folder's attribute; under "LAN Protocol Support", check "FTP" and click *OK*.

Accessing the TeraStation with an FTP Client

- To access the TeraStation via FTP, configure your FTP client software with the following settings:
Hostname: IP address of the TeraStation
Username: The TeraStation's username
Password: The TeraStation's password
Port: 21
- Shared folders connected by FTP are available from the "/mnt" directory. The default locations are:
For RAID 0, RAID 5, or RAID 1:
/mnt/array1/share
/mnt/usbdisk1
/mnt/usbdisk2
For RAID 1 (two arrays):
/mnt/array1/share
/mnt/array2/share2
/mnt/usbdisk1
/mnt/usbdisk2
For JBOD:
/mnt/disk1/share
/mnt/disk2/share2
/mnt/disk3/share3
/mnt/disk4/share4
/mnt/usbdisk1
/mnt/usbdisk2

Accessing the TeraStation with an Anonymous User*

- To allow anonymous access to your FTP share, disable access restrictions.
- To access the TeraStation via anonymous FTP, configure your FTP client software with the following settings:
Hostname: IP address of the TeraStation
Username: anonymous
Password: any character string
Port: 21

*If the TeraStation joins a domain, anonymous users cannot access it.

Notes:

- If a file was created or copied by AFP, you may not be able to delete it using an FTP connection. If this occurs, use an SMB or AFP connection instead to delete the file.
- For FTP connections, make sure that the total filename including directory path is 250 single-byte characters or less.

Cloud Storage

The TeraStation supports Amazon S3, a fee-based online storage service provided by Amazon, and other cloud storage services that share the Amazon S3 API. Follow the steps below to configure your TeraStation to use with your cloud storage service:

Note: Set the TeraStation's time settings to the correct time. Using NTP is recommended. To configure NTP settings on the TeraStation, refer to the "Name, Date, Time, and Language" section in chapter 10.

Configuring Cloud Storage

- 1 In Settings, click *Web Services*.



- 2 Click  to the right of "Cloud Storage".



3 Click *Add*.

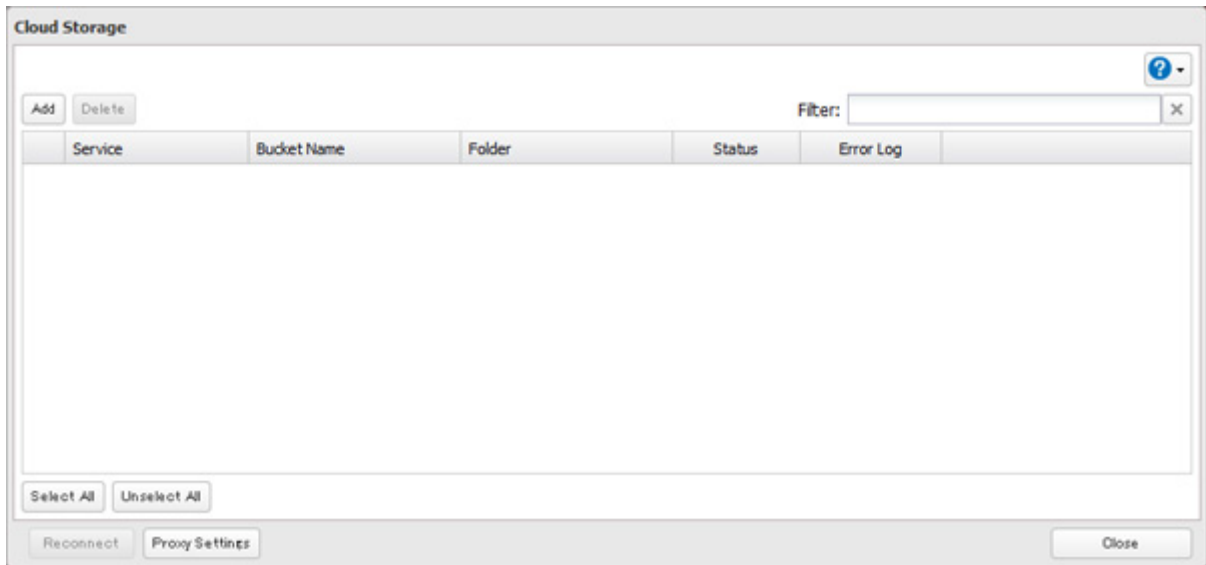

4 Select the service name from the drop-down menu. Enter the bucket name, access key ID, and secret access key; select the storage class and the connection protocol, then click *OK*.

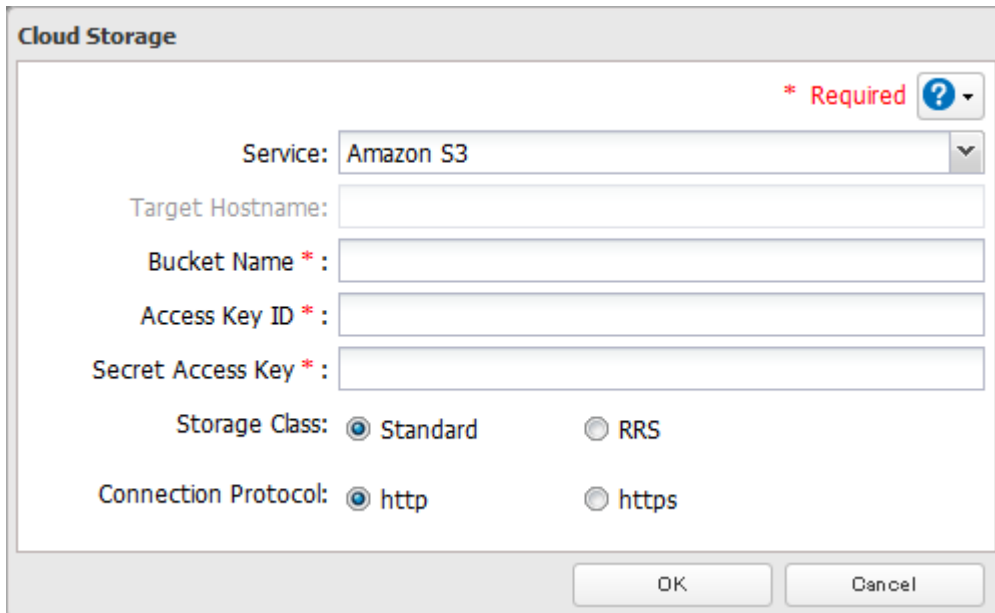

5 Enter a shared folder name to use with the cloud storage service and click *OK*.

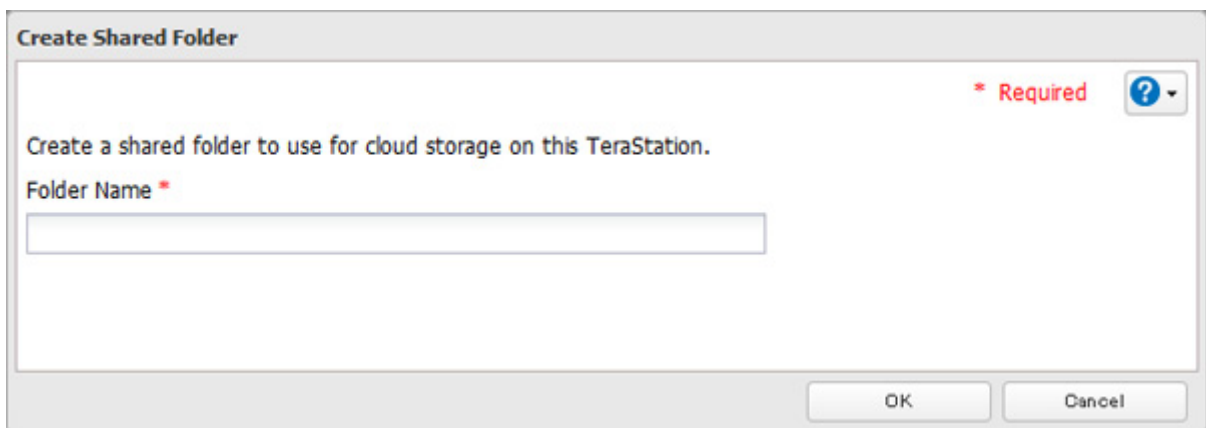

- 6** Under "LAN Protocol Support", check "Backup" and enter the desired shared folder settings. Click *OK*.

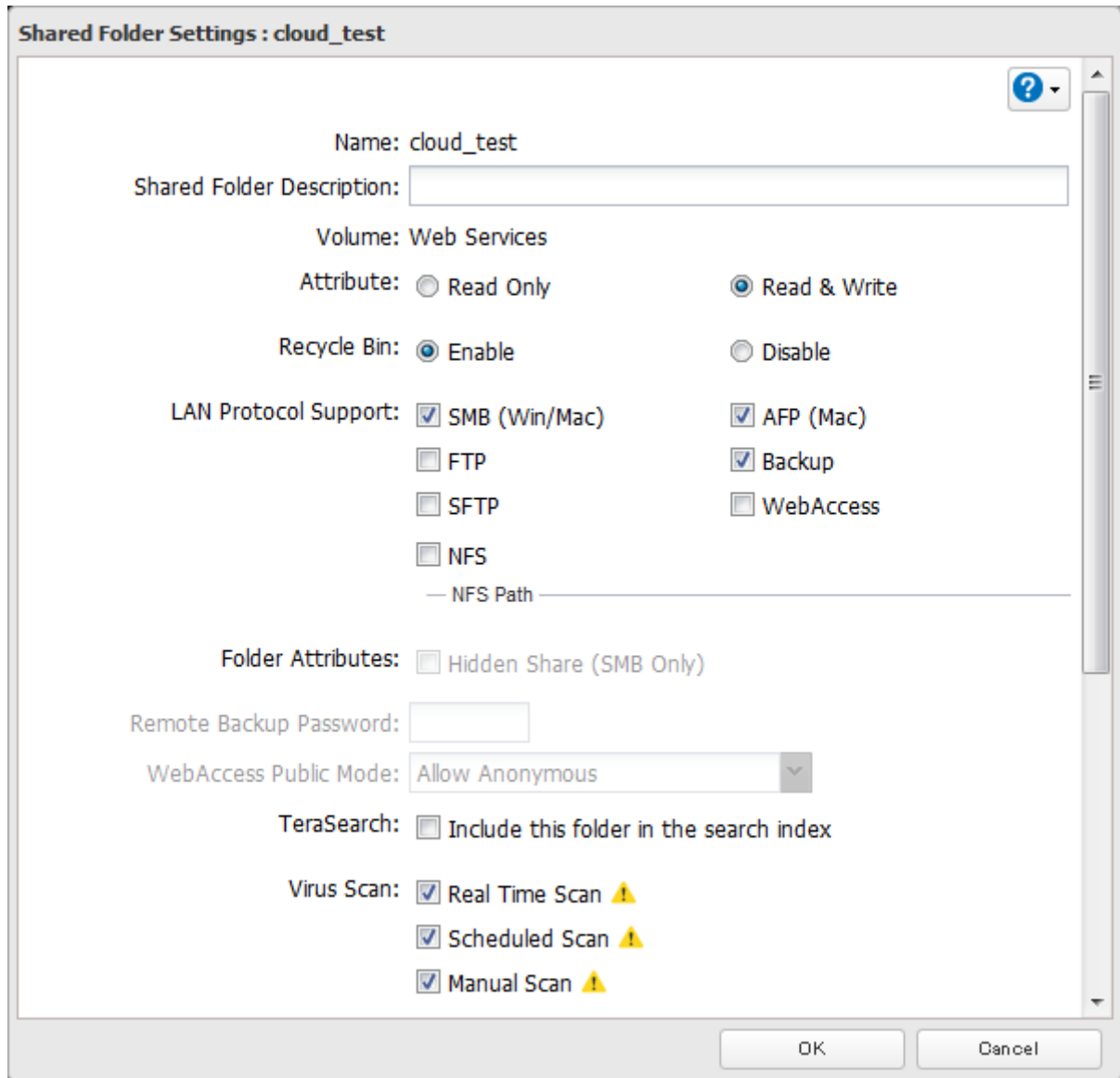

- 7** Click *OK*.
- 8** Click *Close*.

Uploading Files to Cloud Storage

To upload files to cloud storage, using backup job is recommended.

- 1** In Settings, click *Backup*.



- 2** Click  to the right of "Backup".



3 Click *Create New Job*.

Backup List ?

Backup Password:

List of LinkStations and TeraStations

Filter:

Task	Scheduled	Day	Time	Operation Mode	Status
------	-----------	-----	------	----------------	--------

4 Select backup settings such as date and time to run.

Backup Job Settings

* Required ?

Name * :

Schedule: Not scheduled

Date and Time: Sunday 0 Hour 0 Minutes

Operation Mode: Normal backup

Versions: 10

Unlimited

Options: Create a subfolder for backup

Create backup log file

Save backup logs in the backup source folder

Select the folder to save backup logs

Backup Log Target Folder:

Encrypted data transfer

Compress and transfer

Ignore backup errors and continue backup job on schedule

Do not back up recycle bin

Overwrite unchanged files

Filter:

Backup Source Folder Name	Backup Target Folder Name
---------------------------	---------------------------

5 Click *Add*.

6 Click *Browse* under "Backup Source Folder Name".

- 7** Select the shared folder that uploaded files will be saved to, then click *OK*.

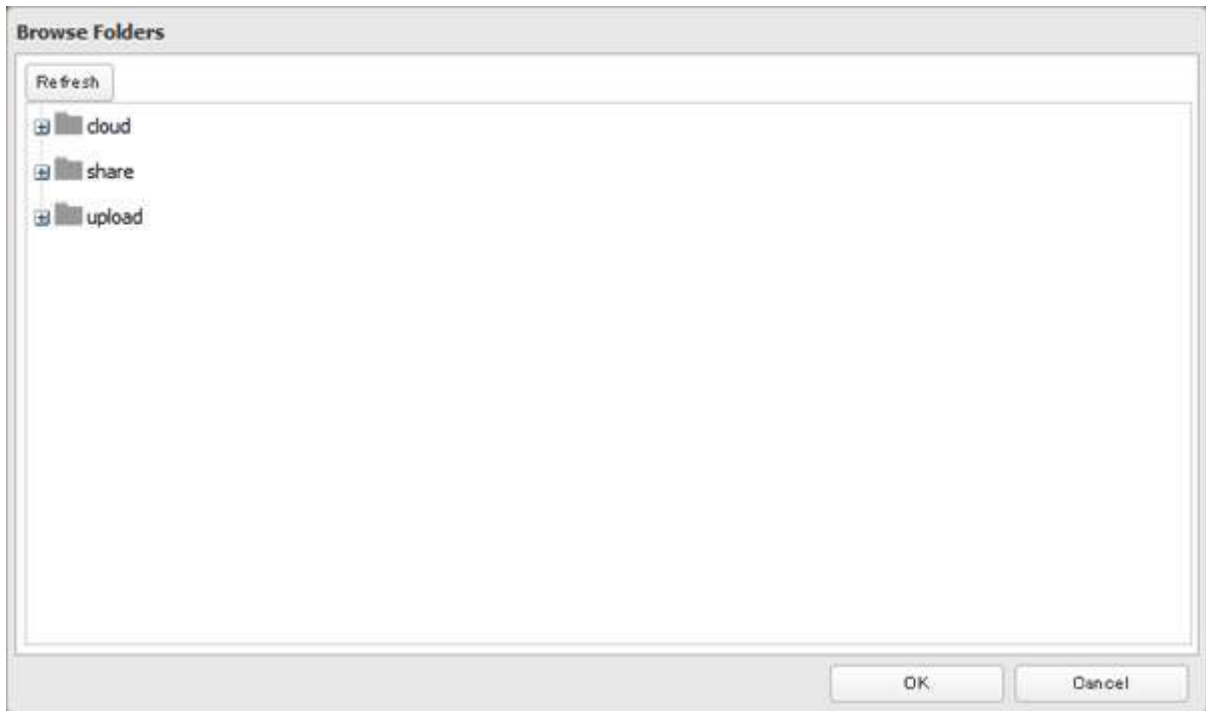

- 8** Click *Browse* under "Backup Target Folder Name".

- 9** Select the shared folder created from the "Configuring Cloud Storage" section above, then click *OK*.

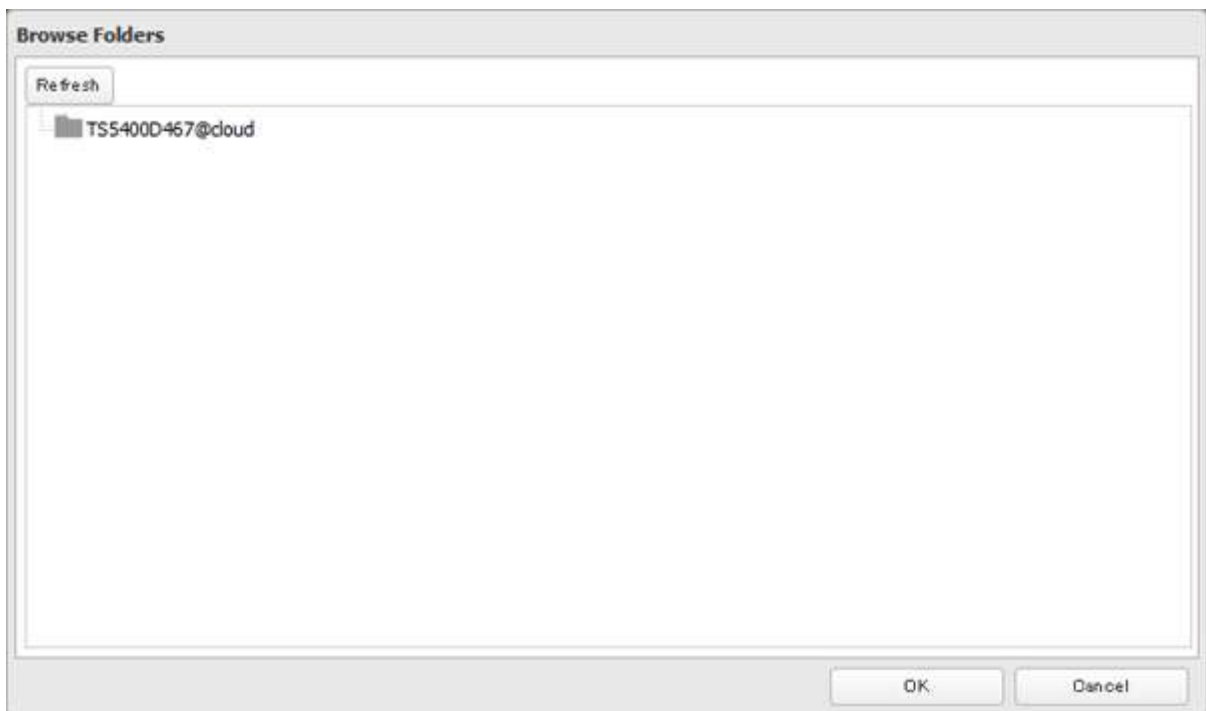

- 10** Click *OK*. Tasks added to "Backup List" are displayed.

- 11** Click *Close*.

Notes:

- If a shared folder created through this process is configured to use NFS, it cannot be mounted from an NFS client.
- Files cannot be uploaded to this shared folder using WebAccess.

- If using the cloud storage through a proxy server, click *Proxy Settings*. In the displayed page, enter the proxy server name, port number, username, and password. Ask your network administrator for detailed proxy server settings.
- To use after the network was temporarily disconnected, click *Reconnect*.
- If a file is added to the bucket from a folder other than the TeraStation's remote replication folder, it may take more than an hour for the file to appear in the TeraStation's remote replication folder. However, when a file is added to the TeraStation's remote replication folder, it immediately appears in the bucket.
- If you enter an incorrect bucket name and then cancel editing the cloud storage service settings, that wrong bucket name may still accidentally be registered. If this happens, reconfigure the cloud storage service settings correctly starting from step 4.
- Be careful with existing files in the target folder, as files with the same name will be overwritten even if copied files are older.
- If you copy a file to the remote folder using Explorer or a backup process, the file will also be uploaded sequentially to the cloud storage bucket. This second uploading process will start in the background during the first copying process and will not be visible. If you shut down or restart the TeraStation immediately after copying a file to the remote folder, the file may not be uploaded to the bucket. Try copying the file again if this occurs.
- If you encounter any upload or download errors, click *Error Log*. The log will display the filename and operation during which the error occurred.
- If uploading fails, try copying the file again. If it still fails, click *Reconnect* or set the cloud storage switch to off and on again, then restart the cloud storage service.
- If transferring or accessing 1 TB or more files from cloud storage, make sure there is enough free space on the TeraStation for temporary file caching. For example, when uploading 1 TB of files to cloud storage, it is recommended to keep at least 2 TB of free space available.

Chapter 7 BitTorrent

BitTorrent is a protocol for distributing large amounts of data efficiently. The information in this chapter is for users who are familiar with BitTorrent.

Note: Use compatibility mode to use the download manager with Windows 8.1 and Windows 8.

- 1 In Settings, click *Applications*.

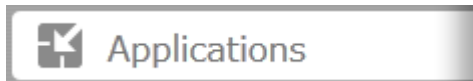

- 2 Click  to the right of "BitTorrent".



- 3 Click *Edit*.

- 4 Click *Browse*.



- 5 Select the shared folder where the downloaded file will be saved, then click *OK*.

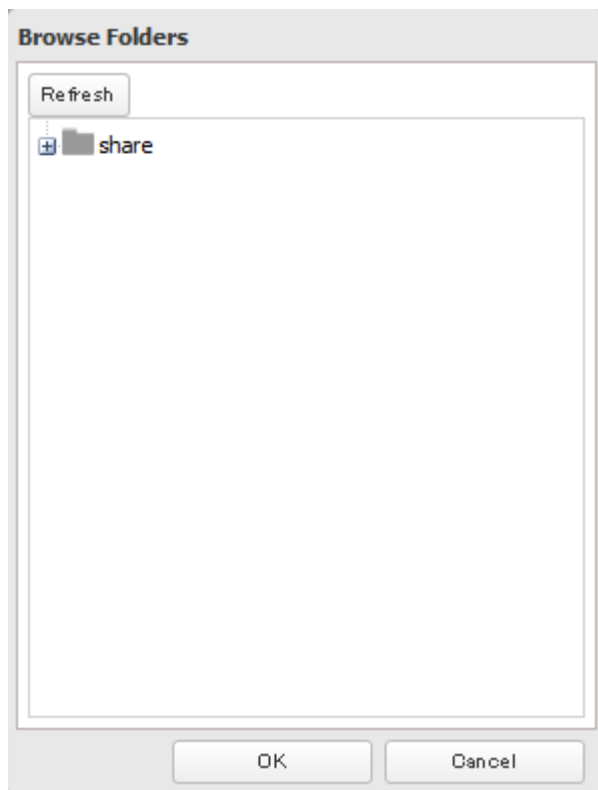

- 6 Click *OK*.

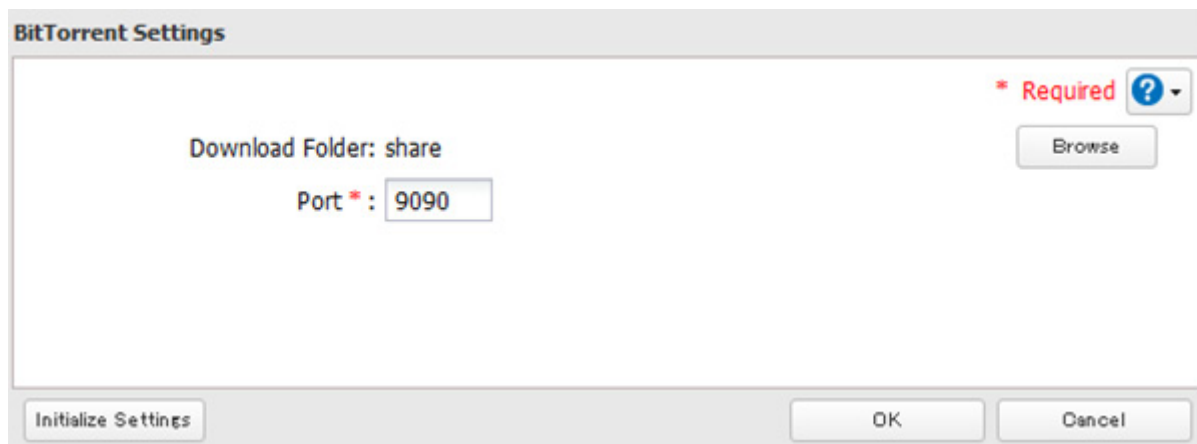

- 7 Move the BitTorrent switch to the  position to enable BitTorrent.

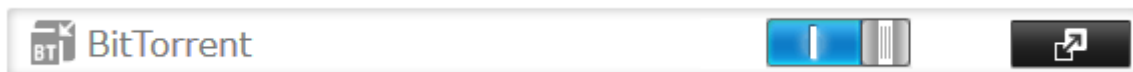

- 8 Click  to the right of "BitTorrent".

- 9** Click *Open Download Manager*. The default username is "admin" and the default password is blank (no password).

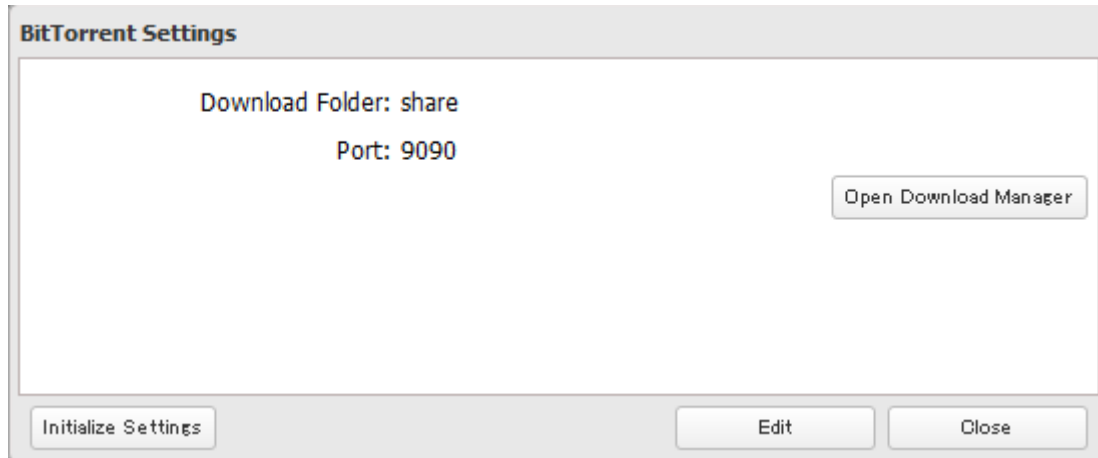

- 10** The download manager will open.

Chapter 8 Multimedia

DLNA

DLNA is a set of guidelines for sharing digital media. The TeraStation includes a DLNA server compliant with the DLNA guidelines. The movies, photos, and music saved on this product can be played back on DLNA-compliant TVs, stereo equipment, game consoles, and other devices within the network.

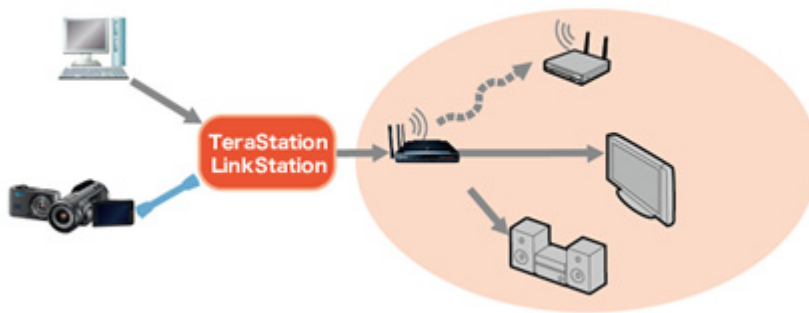

- 1 In Settings, click *File Sharing*.

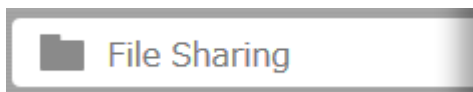

- 2 Click  to the right of "Folder Setup".

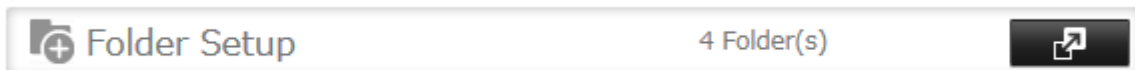

- 3 Select the folder that you want to share with media players and other DLNA-compatible devices.

- 4 Click *Edit*.

- 5 Under "LAN Protocol Support", check "DLNA" and click *OK*.

- 6 Click *Services*.



- 7 Move the DLNA switch to the  position to enable DLNA.



8 Click  to the right of "DLNA Server".

9 Click *Edit*.

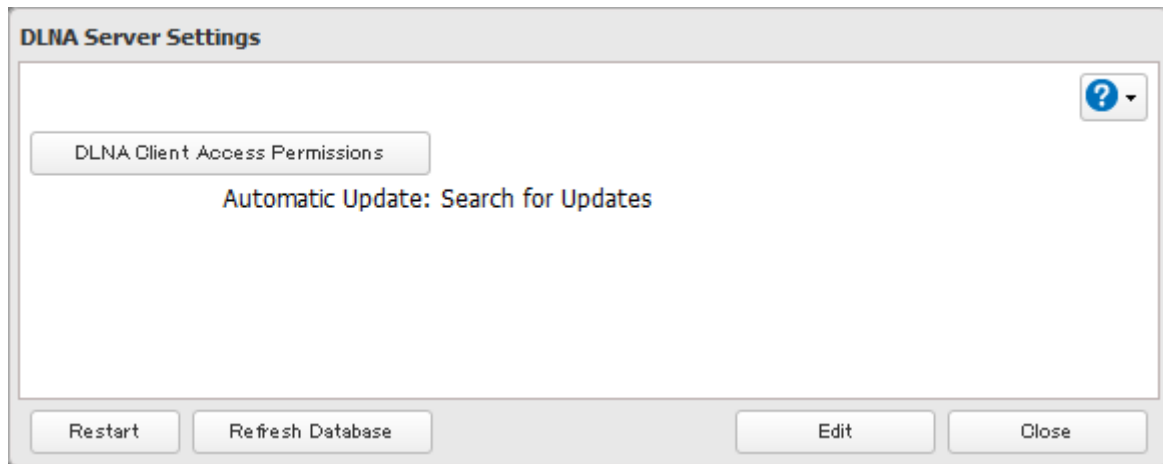

10 Select an interval for DLNA server database updates and click *OK*.

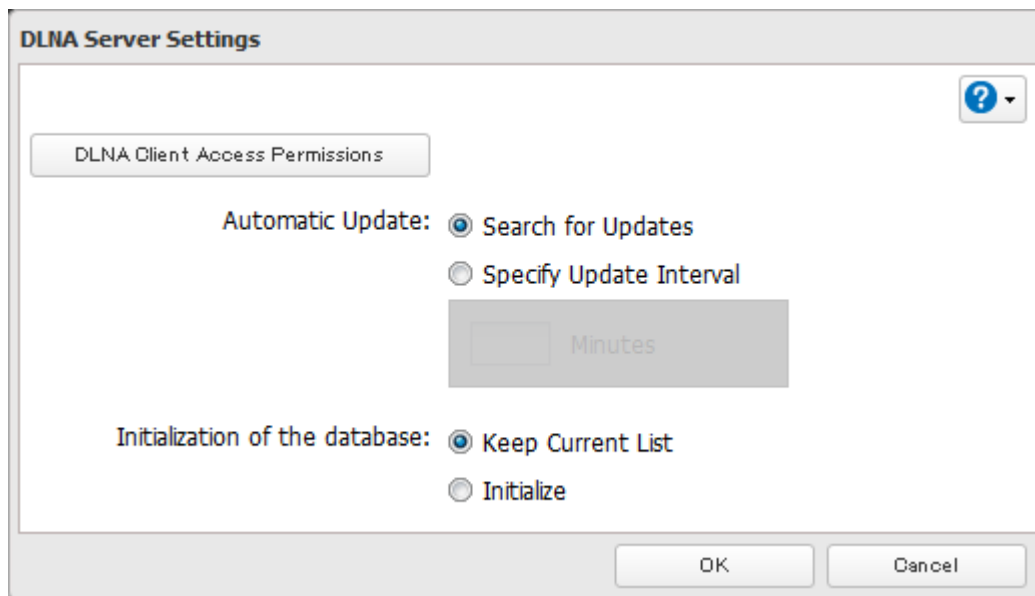

11 Click *OK*.

Playing Files

To play back content from a DLNA-compatible device:

- 1** Connect the DLNA-compatible device to the same network as the TeraStation and turn it on.
- 2** Select the TeraStation in the software of the DLNA-compatible device.
- 3** Select the content to be played back.

Note: For more information on playing files, see the DLNA-compatible devices' manuals.

Connected DLNA-compatible Devices

Follow the procedure below to view the DLNA-compatible devices connected to your TeraStation.

- 1 In Settings, click *Services*.



- 2 Click  to the right of "DLNA Server".

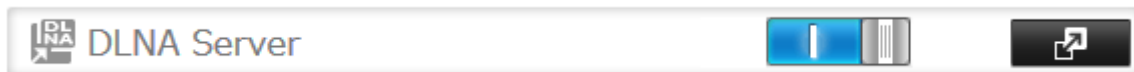

- 3 Click *DLNA Client Access Permissions*.

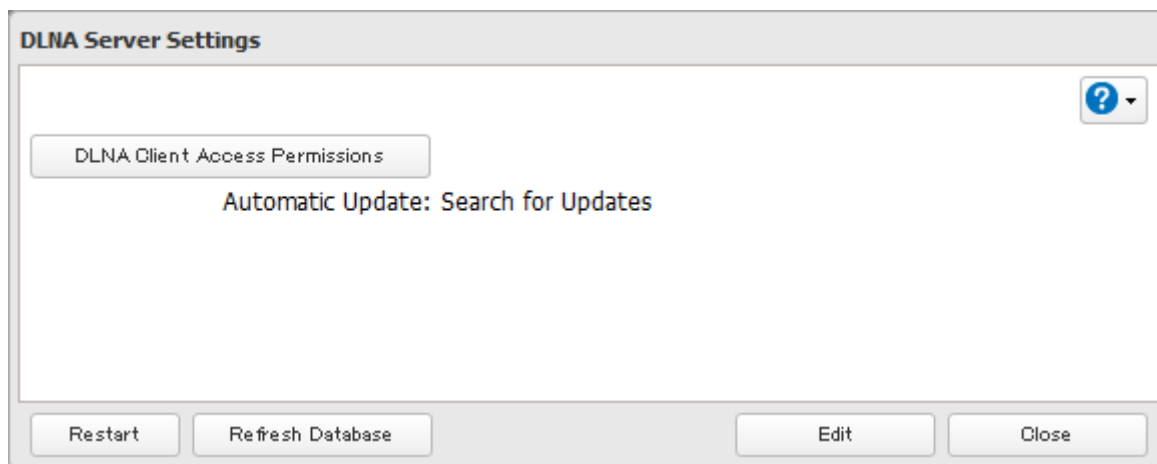

- 4 A list of the MAC addresses, IP addresses, and device names of the DLNA-compatible devices connected to the same network as the TeraStation is displayed. If your device is not listed, click *Refresh Database*.

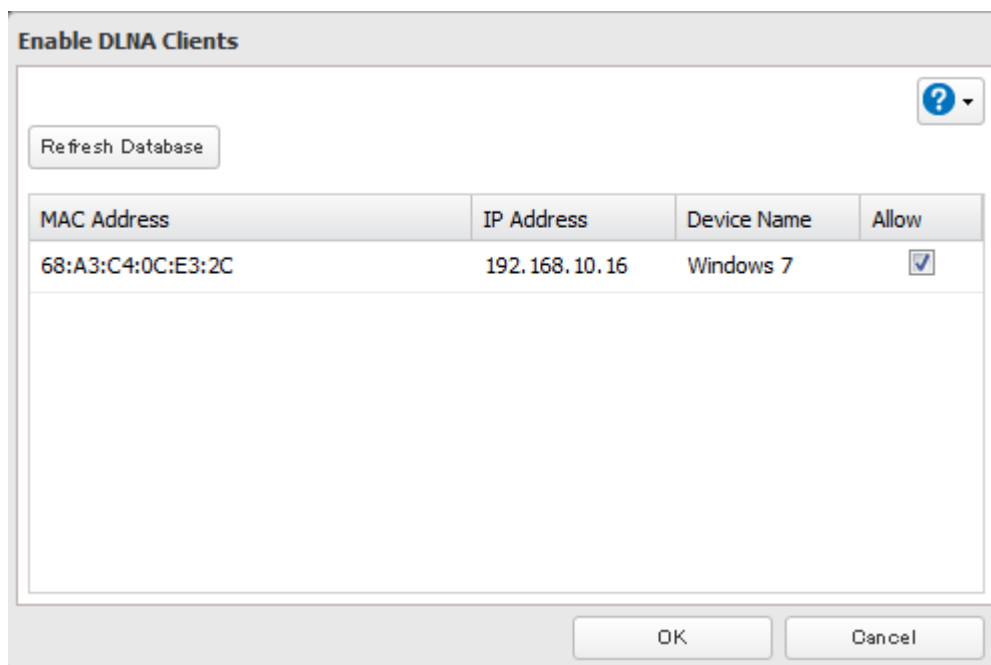

Streaming to DLNA-compatible Devices

When new movies, photos, and music files are added to the TeraStation's DLNA folder, the database must be updated before the new file can be streamed. By default, the database is updated at startup and again every 60 minutes. You can change this interval or update the database manually.

- 1 In Settings, click *Services*.



- 2 Click  to the right of "DLNA Server", then click *Edit*.



- 3 You may change the update interval, or select *Refresh Database* to update the database immediately.

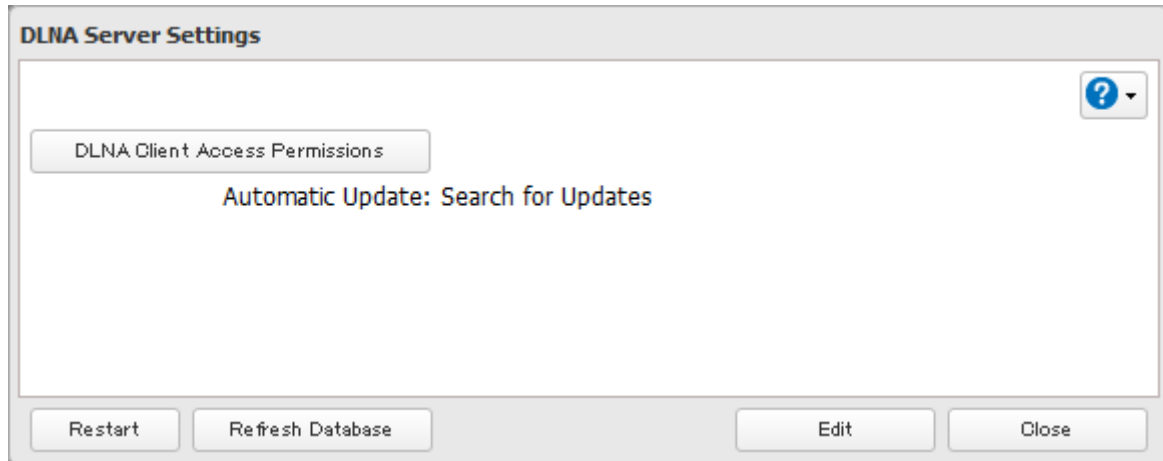

Disabling Playback from Specific Devices

You may block specific DLNA devices from playing back media content.

- 1 In Settings, click *Services*.



- 2 Click  to the right of "DLNA Server".

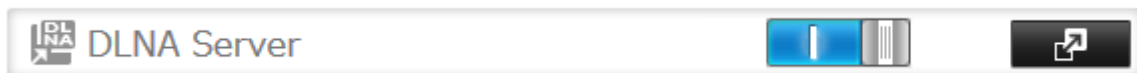

- 3 Click *DLNA Client Access Permissions*.

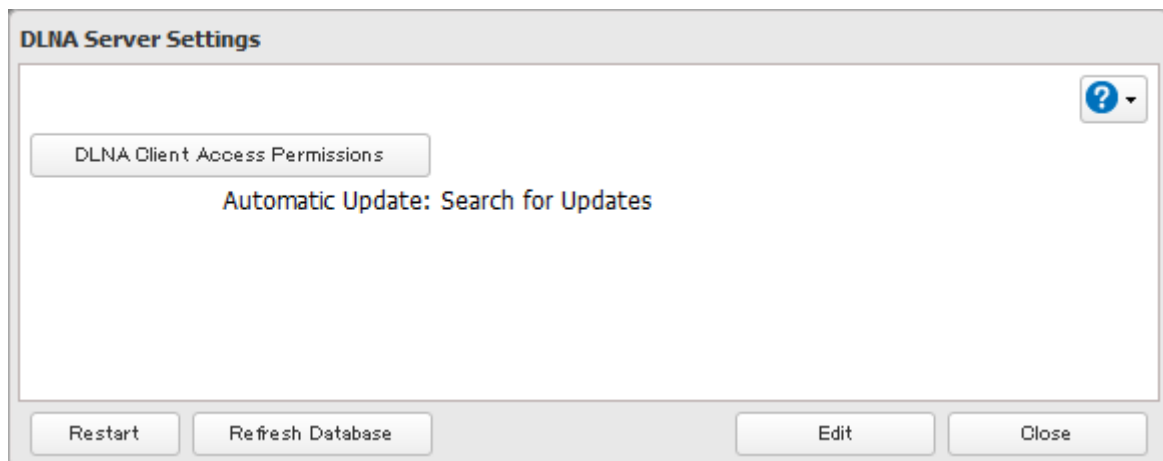

- 4** Uncheck the devices you do not want to allow to play media and click *OK*.

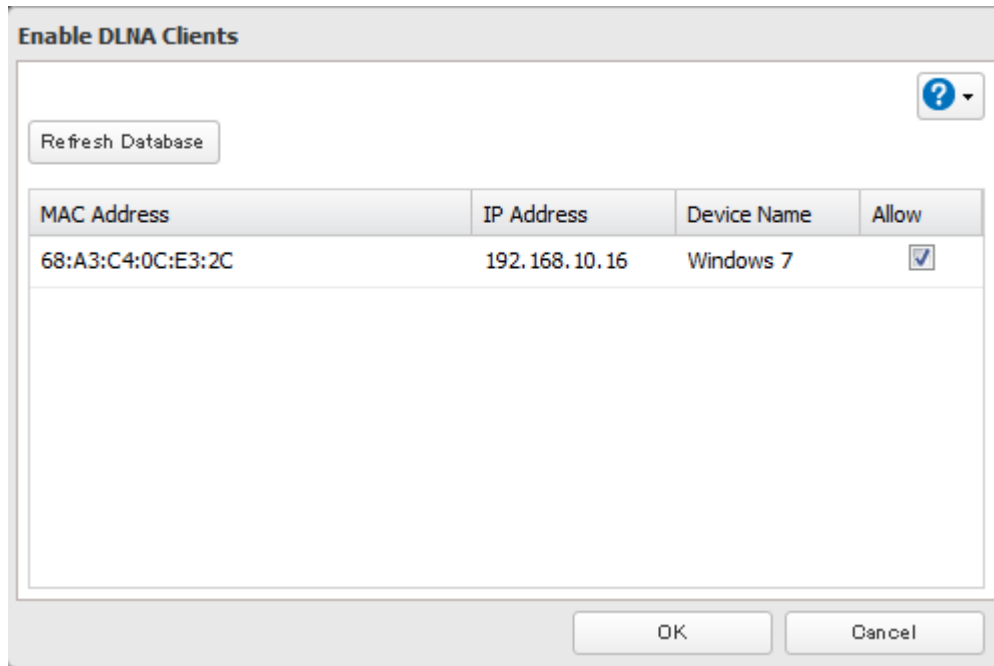

Supported File Types

The TeraStation supports DLNA streaming of files with the extensions below.

Types	File Extensions
Video files	.avi, .divx, .asf, .mpg, .mpe, .m1v, .vob, .mts, .m2ts, .m2t, .mpeg, .mpeg2, .vdr, .spts, .tp, .ts, .3gp, .mov, .m4v, .wmv, .dvr-ms, .xvid, .mp4, .m4v
Picture files	.jpg, .jpeg, .gif, .png, .tif, .tiff, .yuv, .bmp
Music files	.mp3, .mpa, .wma, .aac, .apl, .ac3, .lpcm, .pcm, .wav, .m3u, .m4a, .mp4, .3gp, .m4b, .aif, .aiff, .flac, .ogg, .mp2, .mp1, .mp4

iTunes Server

If iTunes server is enabled, computers on your network with iTunes can play music files stored on the TeraStation and transfer them to iPod, iPhone, and iPad devices. iTunes server supports playback from up to five computers.

Configuration

- 1** In Settings, click *Services*.



- 2** Click  to the right of "iTunes Server".



3 Click *Edit*.

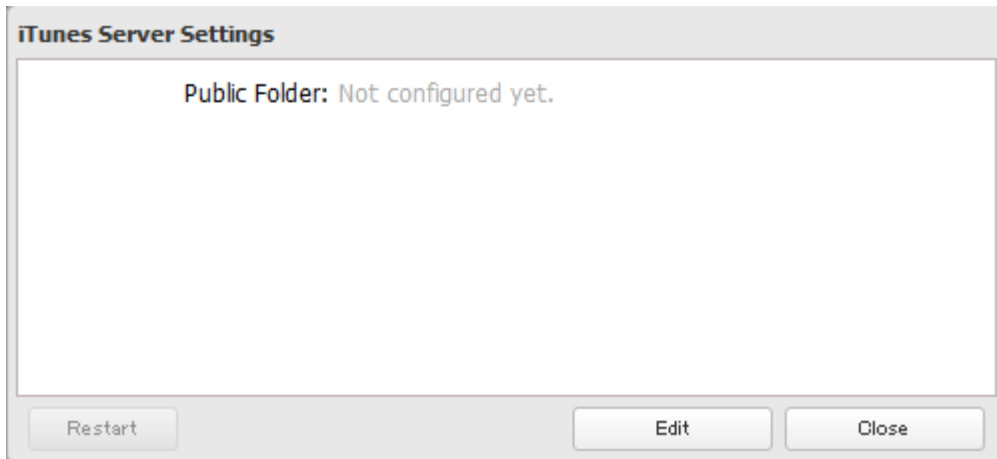

4 Click *Browse*.



5 Select the shared folder that you want to make available to iTunes, then click *OK*.

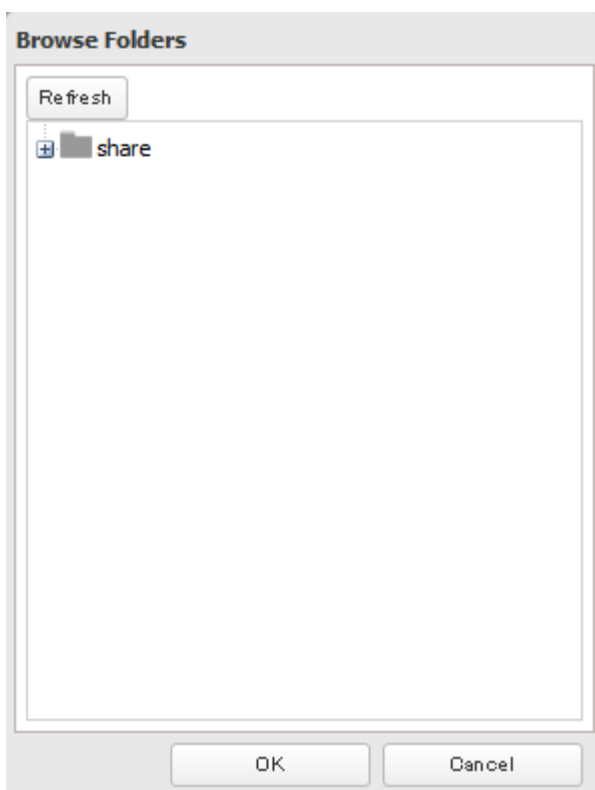

6 Click *OK*, then *OK* again.

7 Move the iTunes server switch to the  position.



Squeezebox Server

Squeezebox is a network music player by Logitech that can play back music stored on your network using your wired or wireless LAN without a computer. Squeezebox supports mp3, flac, ogg, he-aac v2 and wma.

Configuration

1 In Settings, click *Services*.



2 Move the Squeezebox server switch to the  position to enable Squeezebox server.



3 Click  to the right of "Squeezebox Server".

4 Click *Edit*.

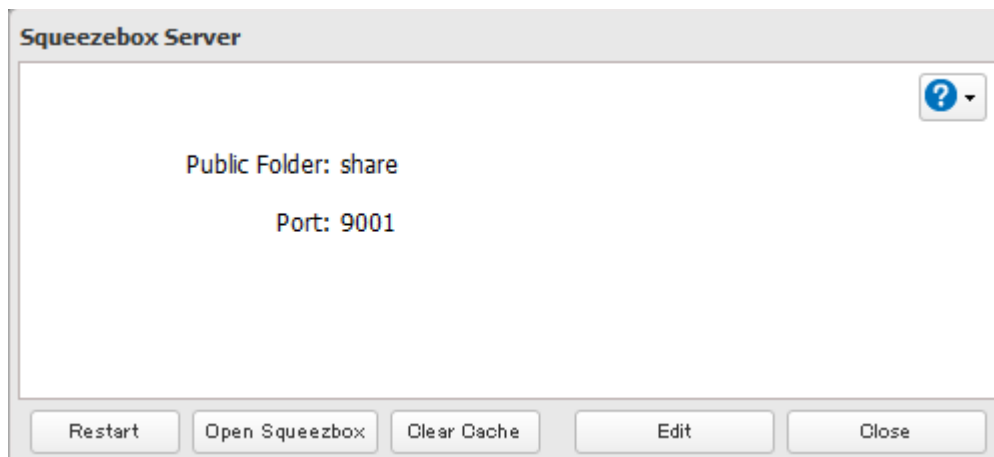

5 Click *Browse*.

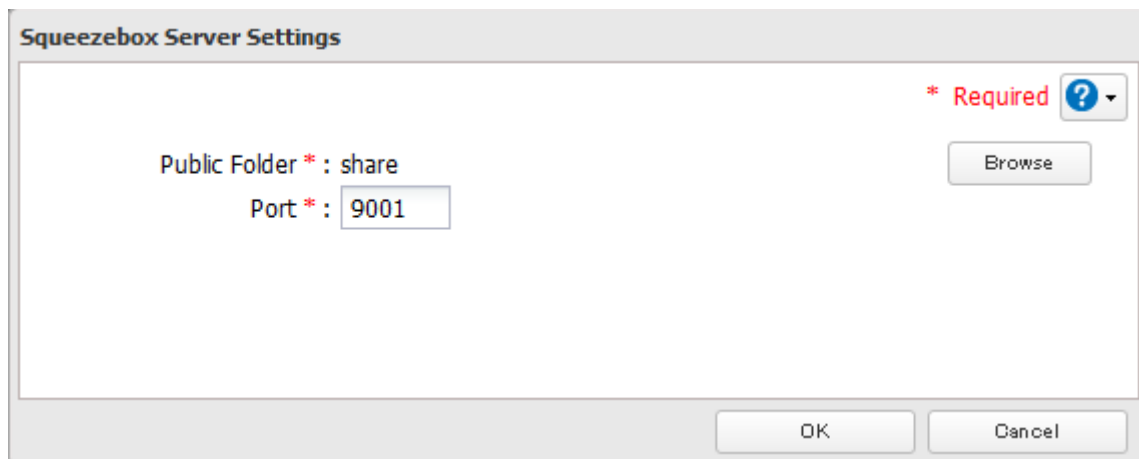

6 Select the shared folder that you want to make available to Squeezebox, then click *OK*.

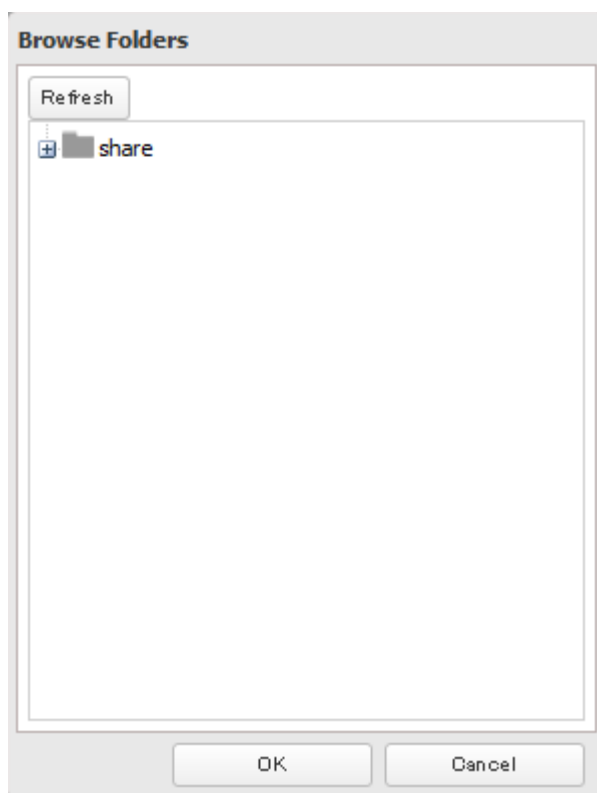

7 Enter port number (9001 is recommended), then click *OK*.

8 Click *OK*.

9 Click *Open Squeezebox*.



The Squeezebox's settings will open.

Chapter 9 Surveillance Server

The TeraStation supports streaming video from RTSP (Real Time Streaming Protocol) network cameras.

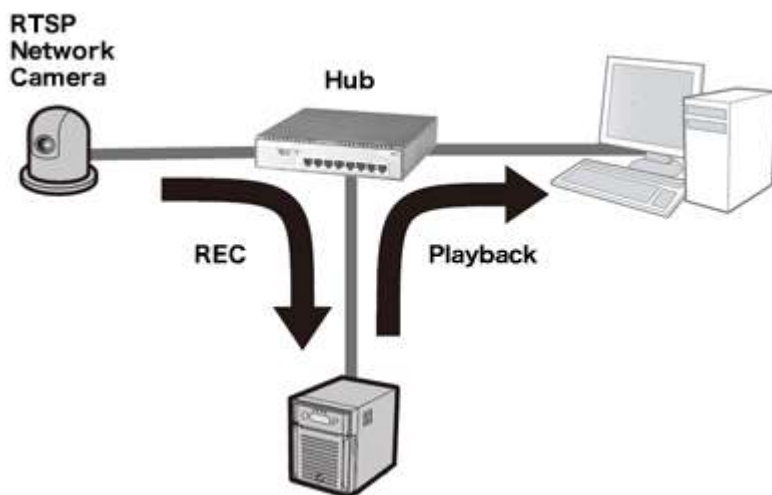

Getting Started

The following items are required:

- TeraStation with surveillance camera support
- Supported network camera
- Ethernet cable
- Ethernet hub
- Computer

Supported operating systems: Windows 8.1 (64-bit or 32-bit)*, Windows 8 (64-bit or 32-bit)*, Windows 7 (64-bit or 32-bit), Windows Vista (64-bit or 32-bit), Windows XP SP3, Windows Server 2008 SP2 (64-bit or 32-bit), Windows Server 2003 SP2, OS X 10.5.8 or later

CPU: Intel dual-core 2.20 GHz or faster

Hard drive: 10 GB or more of available space

RAM: 2 GB or more

*Log in to Windows 8 or Windows 8.1 with a local admin account, not a Microsoft account. If you log in with a Microsoft account, you will not be able to access the surveillance server on the TeraStation.

Live Viewer Requirements:

Supported operating systems: Windows 8.1 (64-bit or 32-bit), Windows 8 (64-bit or 32-bit), Windows 7 (64-bit or 32-bit), Windows Vista (64-bit or 32-bit), Windows XP SP3

CPU: Quad-core 2.33 GHz or faster

Hard drive: 10 GB or more of available space

RAM: 2 GB or more

Note: Surveillance cameras cannot be used if failover is configured. Also, failover cannot be used if surveillance camera functionality is enabled. They're just not compatible.

Installing Client Tools

Download "Buffalo Surveillance Camera Client Tools Setup" from the Buffalo website and install the following client tools using the install wizard on your computer.

Camera Policies - Registers that a network camera is connected and ready to record.

Live Viewer - Lets you view video as it is being recorded. With some network cameras, pan, tilt, zoom, focus, and other remote operations may be unavailable.

Data Service Policies - Used to move, back up, and delete recorded video data.

Vault Admin - Used to perform license registration, self-diagnosis, check the remaining disk space, and other operations.

Surveillance Video Manager - Used to view recorded video data, perform searches, export, and other operations.

Network Activity - Displays the operating status of the TeraStation.

Notes:

- Install after logging into your computer using an account with administrator rights.
- Install another media player to play recorded videos if the version of "Buffalo Surveillance Camera Client Tools Setup" is 5.7.3.2 or later.
- Install VideoLAN VLC media player 1.11–1.13, or Apple QuickTime 7 or later if the version of "Buffalo Surveillance Camera Client Tools Setup" is older than 5.6.19.3. VLC media player 2.0.x may not work with some network cameras. Using VLC media player is recommended if your network camera records in MPEG-4 format.
- If VLC media player is installed, use the default installation location (C:\Program Files (x86)\VideoLAN\VLC in Windows 7 64-bit or the Application folder in Mac OS).
- If surveillance cameras or client tools installed under C:\Program Files (x86)\BUFFALO\SurveillanceServer\Bin are blocked due to the OS firewall, refer to the OS help for instructions about how to disable the firewall.
- Install client tools on one or more computers connected to the same network as the network camera(s) and the TeraStation. Surveillance camera settings are shared for all computers on the network.

Connecting Devices to the Network

Connect the following devices to the network.

- A TeraStation that supports surveillance cameras
- A compatible network camera
- A computer with the above client tools installed

Notes:

- Connect all devices on the same network subnet.
- Set the TeraStation's and network camera's time settings to the correct time. To select a different NTP server on the TeraStation, refer to "Name, Date, Time, and Language" section in chapter 10. In certain cases, the DNS server address must be set in order to access the NTP server.
- Use the dedicated utility provided with the network camera or other program to confirm that the network camera is operating properly.

Enabling Surveillance Cameras

Enable surveillance cameras in Settings.

Note: First, complete the initial settings for the TeraStation and the network camera. For details on the procedure, see the manual supplied with the device.

- 1 In Settings, click *Applications*.

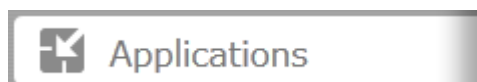

2 Click  to the right of "Surveillance Cameras".



3 Click *Edit*.

4 From "LAN Port", select the LAN port connected to the same network as the network camera and computer where the client tools are installed.

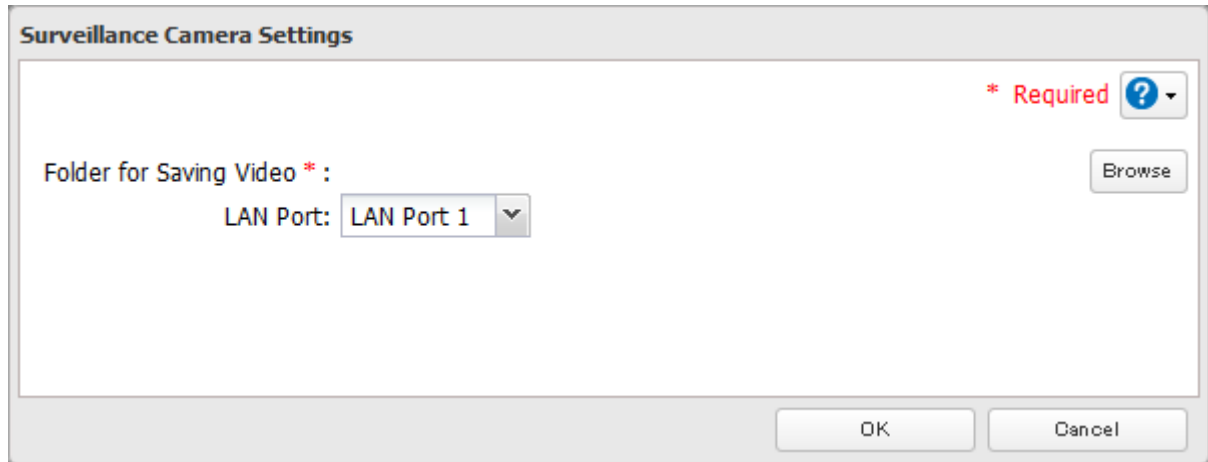

5 Click *Browse*.

6 Choose a folder for recorded video, then click *OK*.

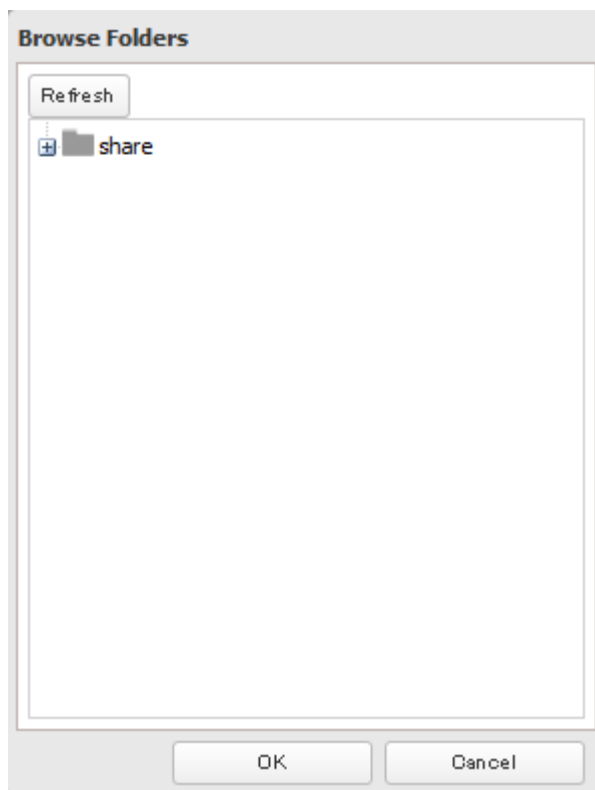

Note: Use a folder with at least 100 GB of available space.

7 Click *OK*.

8 Click *OK*.

9 Move the surveillance camera switch to the  position.



Notes:

- If the target shared folder specified as the storage location for recorded video is deleted, the surveillance camera is automatically disabled.
- Do not directly edit recorded video data in the shared storage folder. If a file is directly edited, the surveillance camera may no longer operate properly.
- Do not duplicate or back up the recorded videos with the backup or replication functions in the TeraStation's Settings. A separate backup license must be purchased to back up this data to another TeraStation.
- The client tools can only be used with the LAN connected to the selected LAN port.

Use with Two or More Network Cameras

In the default settings, only one network camera can be used. To use two or more network cameras, additional licenses (sold separately) must be purchased and registered. For more details to add licenses and registration, see "Activating Additional Licenses" section.

Enabling the Free License

Your TeraStation comes with a license for one surveillance camera. Follow the procedure below to enable the included license.

Note: If port trunking is enabled, the free license cannot be activated. To activate the license, disable port trunking, then follow the procedure below.

- 1 Connect the TeraStation to the Internet.
- 2 Click *Start - BUFFALO - BUFFALO Surveillance Server - Vault Admin*.
For Windows 8.1 and Windows 8, click *Vault Admin* in the Start menu.
- 3 Select the TeraStation where you want to add the license, right-click it, and click *Properties*.

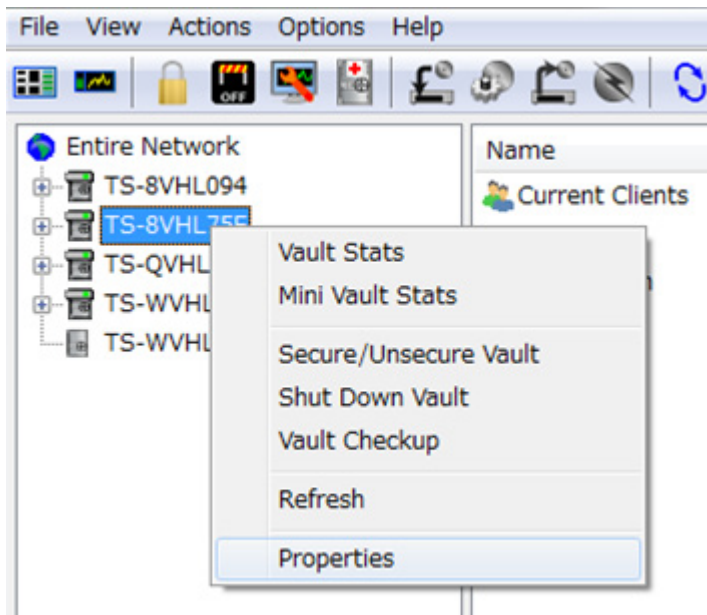

Note: If your computer joins a Public network, the TeraStations may not be detected. In such case, let the computer join a Home or Work network.

- 4 Open the *License* tab, then click *Activate Free License*.

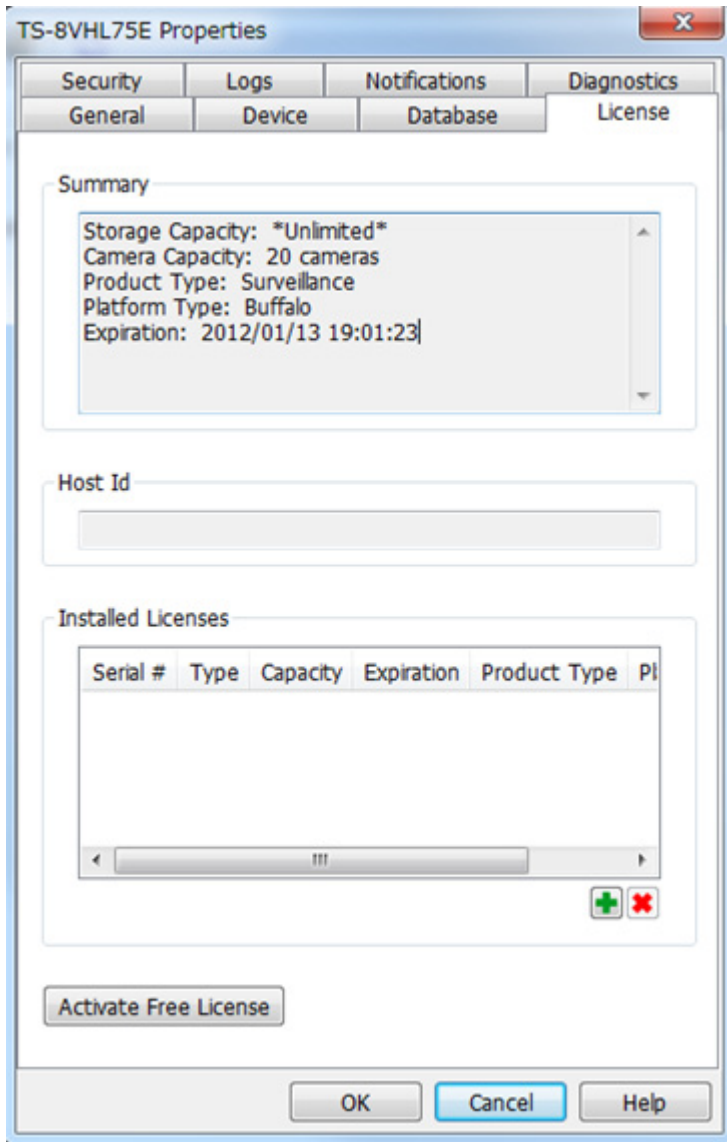

To deactivate the license, click .

- 5** Make sure that "SurveillanceCamera" and "HardDisk" were added to "Installed Licenses".

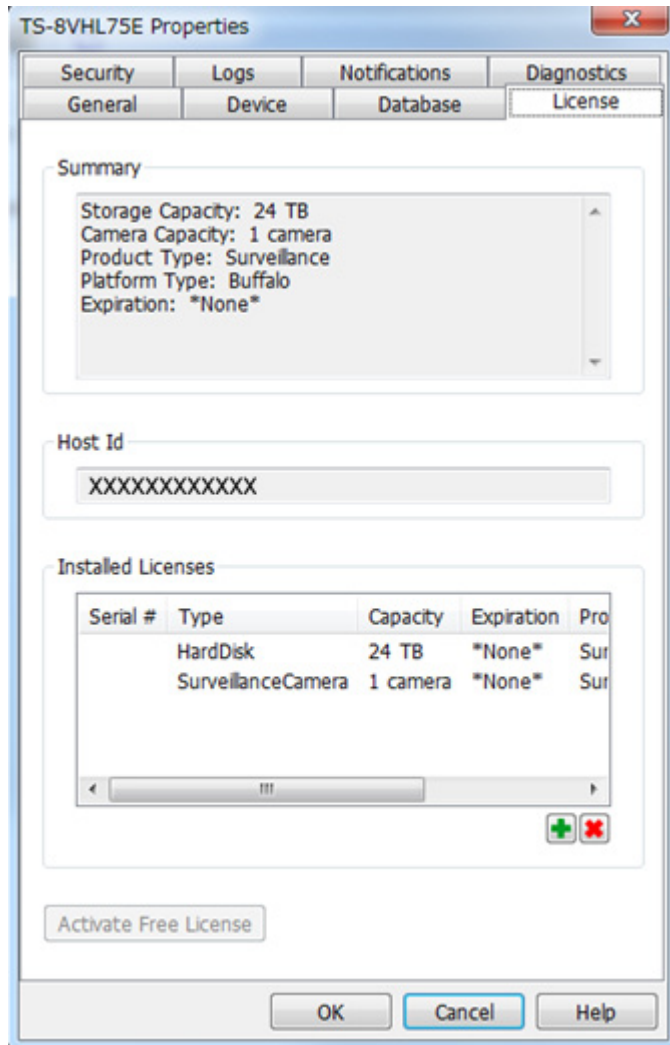

The free license is now enabled.

Registering Recording Policies

Register the network camera that is used.

- 1** Click *Start - BUFFALO - BUFFALO Surveillance Server - Camera Policies*.
For Windows 8.1 and Windows 8, click *Camera Policies* in the Start menu.
- 2** Click the  icon.

3 Click Next.



Welcome to the Add Camera Wizard

This wizard helps you add and schedule a new camera.
You may need to run this wizard with administrative rights.

To continue, click Next.

About Help

< Back Next > Cancel

4 Click *Find Cameras*.



Camera Information

Find cameras on my network to populate the information below.

Find Cameras

Select the manufacturer and model.

- Select Manufacturer - - Select Model -

What is the IP Address?

What credentials are needed to access this camera?

User Name:

Password:

Test Camera

Camera Not Listed

Help

< Back Next > Cancel

- 5 Select the detected network camera, then click *OK*.

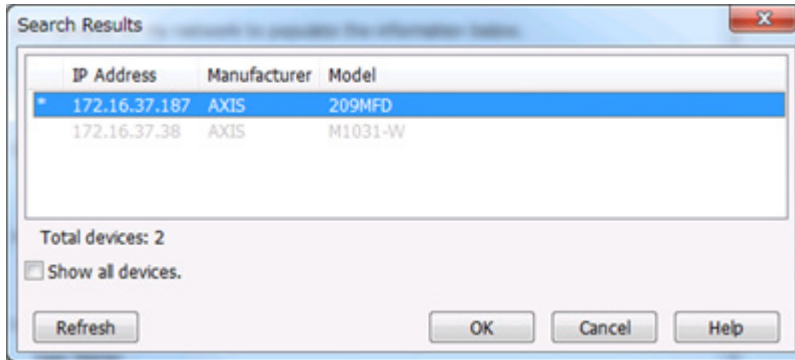

Note: Network cameras that are already in use are indicated by an asterisk (*) and are grayed out.

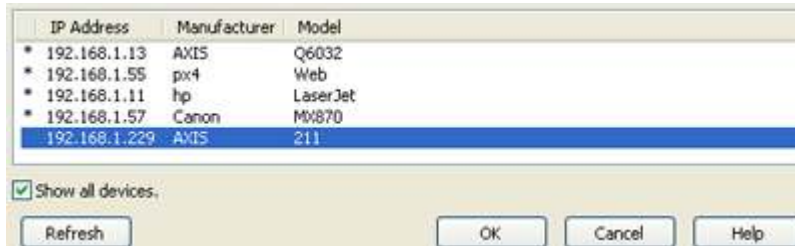

- 6 Enter the username and password if they are configured, then click *Next*.

Note: Clicking *Test Camera* runs an operational check on the network camera.

- 7 Enter the description, then click *Next*.



Description

What is the name of this camera? (For example, 'Front Lobby')

Enter a brief description of this camera.

Help

< Back Next > Cancel

- 8 Select the recording schedule, then click *Next*.



Recording Schedule

When do you want to record video?

Always At selected times

Help

< Back Next > Cancel

- 9 Select the TeraStation where the video will be recorded, then click *Next*.



Recording Computer

What computer will be used for recording video?

- Select Computer -

Help

< Back Next > Cancel

10 Check the registration information; if it is correct, click *Next*.



Ready to Add

Review the summary below before clicking *Next* to add the camera.

Camera name: Rear Entrance
Description: Panasonic camera at back door onto Ash Street.
Manufacturer: Panasonic
Model: BL-C111A
IP Address: 126.34.52.88
User Name: <Empty>
Password: <Empty>
Schedule: M-W-F-- 07:00:00 - 10:00:00
Recording Computer: Diego

11 Click *Next*.

An additional network camera can be registered by selecting "Yes" when asked "Do you want to add an additional camera?"



List of Cameras Added

Rear Entrance at 126.34.52.88 scheduled on M-W-F-- 07:00:00 - 10:00:00

Remove selected Camera

Do you want to add an additional camera?

Yes No

12 Click *Finish*.

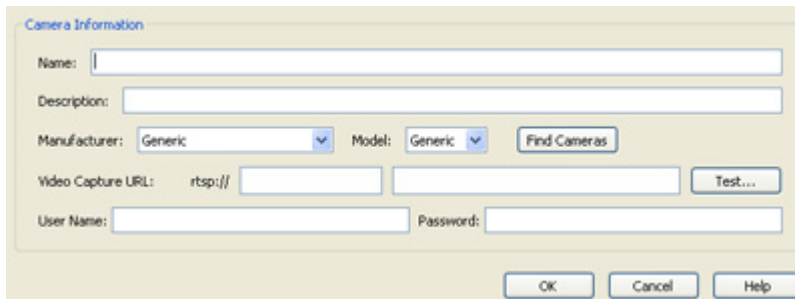

The screenshot shows a 'Camera Information' dialog box with the following fields and controls:

- Name: [Text Input]
- Description: [Text Input]
- Manufacturer: Generic [Dropdown] Model: Generic [Dropdown] Find Cameras [Button]
- Video Capture URL: rtsp:// [Text Input] [Text Input] Test... [Button]
- User Name: [Text Input] Password: [Text Input]
- OK [Button] Cancel [Button] Help [Button]

13 Click *Save*.

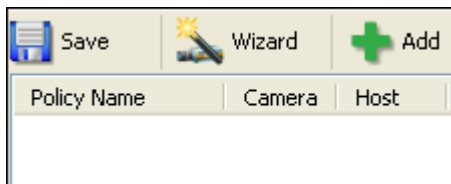

Recording will begin. You've now registered the recording policy of the network camera.

Checking Recording

To check that recording is working correctly, follow the procedure below. Wait at least 15 minutes after registering the recording policy before checking the recording.

- 1 Click *Start - BUFFALO - BUFFALO Surveillance Server - Surveillance Video Manager*.
For Windows 8.1 and Windows 8, click *Surveillance Video Manager* in the Start menu.

- 2 Click *Search*.

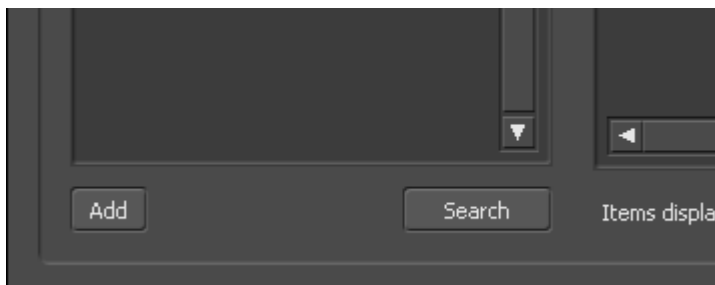

- 3 Recorded video clips are shown in the center of the screen. Click a video clip to start playback.

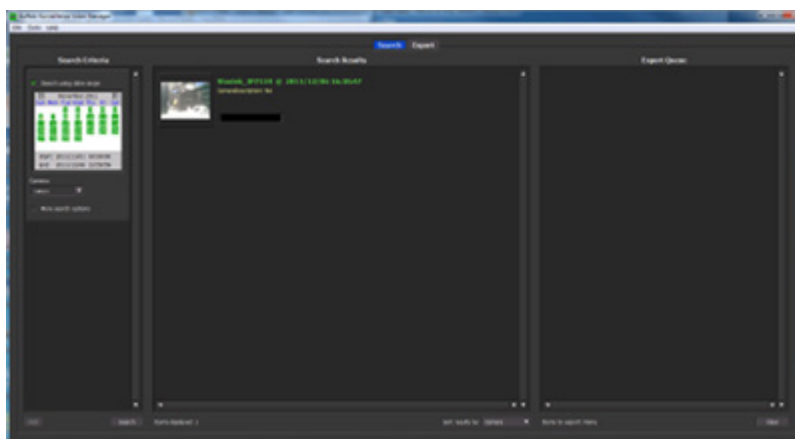

This completes checking recording.

Viewing Saved Video

Follow the procedure below to view recorded data saved in the TeraStation.

- 1 Click *Start - BUFFALO - BUFFALO Surveillance Server - Surveillance Video Manager*.
For Windows 8.1 and Windows 8, click *Surveillance Video Manager* in the Start menu.
- 2 Click *Search*.

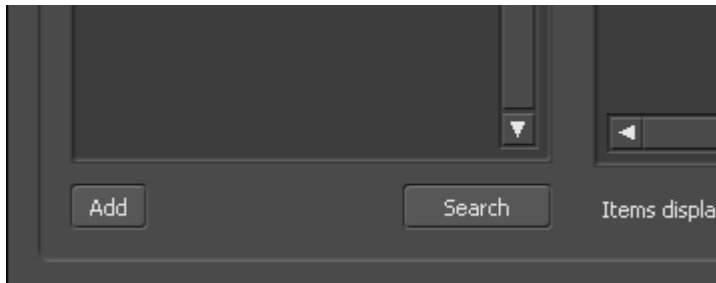

- 3 Video clips are shown in the search results at the center of the screen. Click the clip to start playback.

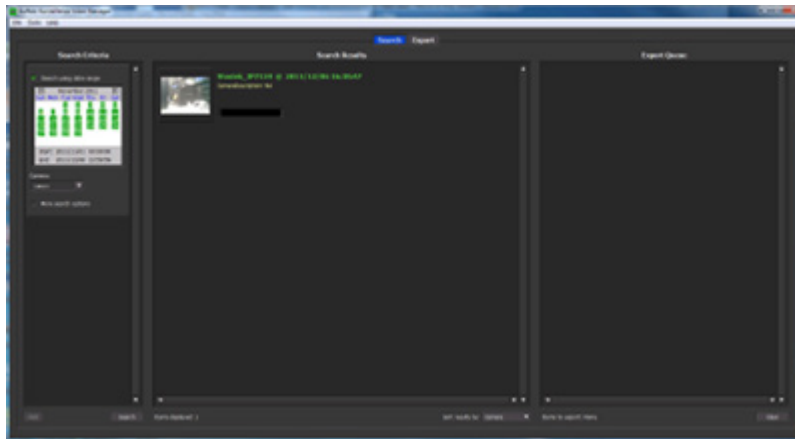

Advanced Usage

Export Recorded Data as a MOV Video File

To export recorded data saved to the TeraStation as a MOV format video file:

- 1 Click *Start - BUFFALO - BUFFALO Surveillance Server - Surveillance Video Manager*.
For Windows 8.1 and Windows 8, click *Surveillance Video Manager* in the Start menu.

- 2 Select the search criteria on the left side of the search screen, then click *Search*.

Search Criteria

Search using date range

April 2010						
Sun	Mon	Tue	Wed	Thu	Fri	Sat
				1	2	3
4	5	6	7	8	9	10
11	12	13	14	15	16	17
18	19	20	21	22	23	24
25	26	27	28	29	30	

Start: 2010/04/06 00:00:00
End: 2010/04/06 23:59:59

Camera:
<any>

More search options

Camera Pool:
<any>

Camera Description:

Show video stored on:
<any>

Show video captured by this computer:

Show video stored on this media:
<any>

Show video stored in this storage pool:
<any>

Add Search Items displayed: None

3 The search results are displayed. Click a thumbnail to start the media viewer.

The screenshot shows a search results window with a dark grey background. At the top, there are two buttons: "Search" (highlighted in blue) and "Export". Below the buttons is the title "Search Results". The main area contains four search results, each with a thumbnail image on the left and text on the right. The thumbnails show a split-screen view of a street scene. The text for each result includes the camera name "Axis211", the time of the search, and technical details like "CameraName", "CameraDescription", "Host", "FrameSize", and "BeginTimeDate". At the bottom of the window, there are navigation arrows and a status bar showing "Items displayed: 573" and "Sort results by: Camera" with a dropdown arrow.

Search Export

Search Results

Axis211 @ 2010/02/17 17:25:42
CameraName: Axis211 CameraDescription: In
Host: Diego FrameSize: 640 x 480
BeginTimeDate: 2010/02/17 17:25:42 RunTim

Axis211 @ 2010/02/17 17:30:42
CameraName: Axis211 CameraDescription: In
Host: Diego FrameSize: 640 x 480
BeginTimeDate: 2010/02/17 17:30:42 RunTim

Axis211 @ 2010/02/17 17:35:43
CameraName: Axis211 CameraDescription: In
Host: Diego FrameSize: 640 x 480
BeginTimeDate: 2010/02/17 17:35:43 RunTim

Axis211 @ 2010/02/17 17:40:43
CameraName: Axis211 CameraDescription: In
Host: Diego FrameSize: 640 x 480
BeginTimeDate: 2010/02/17 17:40:43 RunTim

Items displayed: 573 Sort results by: Camera

- 4 Select the section to export and click *Export*. This will register the video to the export queue.



- 5 Open the Export screen, register the export information from "Export Job Configuration", and click "Start Export". The video is exported in MOV format.

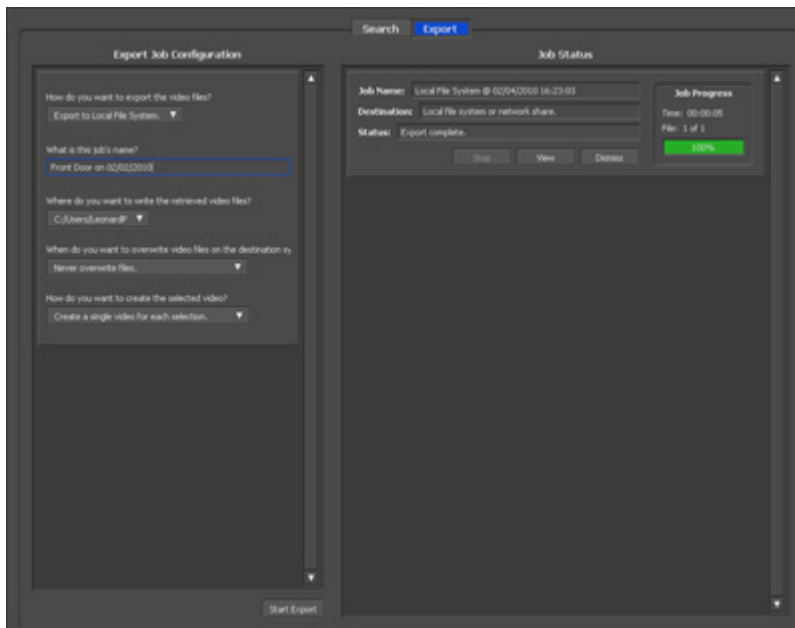

This completes exporting video in the MOV format.

Viewing Video Real-time

Follow this procedure to view the video as it is being recorded by the network camera.

Note: Live Viewer data cannot be viewed.

- 1 Click *Start - BUFFALO - BUFFALO Surveillance Server - Live Viewer*.
For Windows 8.1 and Windows 8, click *Live Viewer* in the Start menu.

- Registered network cameras are listed in the "Cameras" folder on the right side of the screen. To view a video that is currently being recorded, double-click the camera whose video you want to view or drag to a frame of the camera viewer on the left side of the screen.

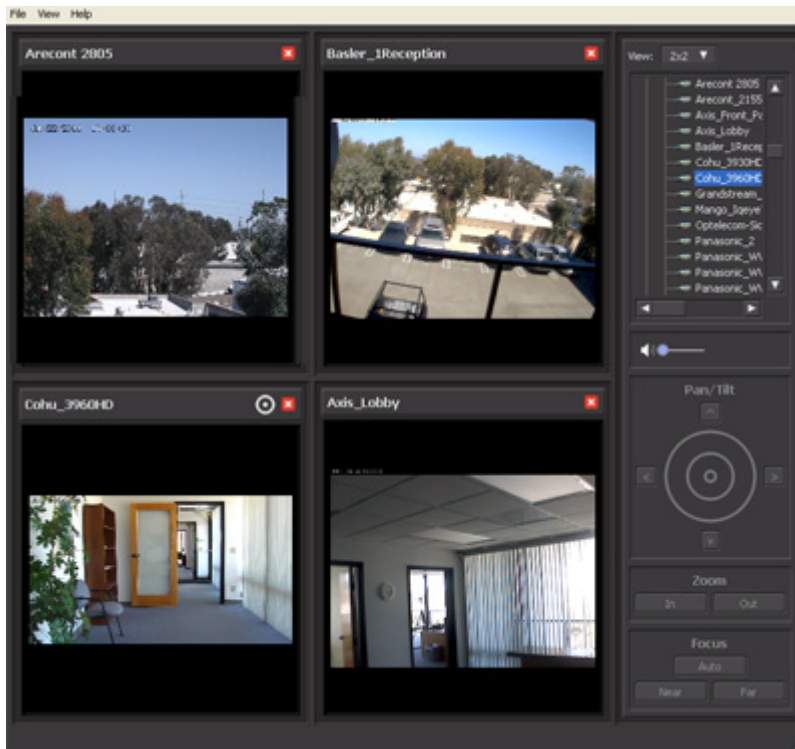

This completes viewing current video.

Moving Recorded Video Data to Another TeraStation

Follow the procedure below to move (migrate) the recorded video data to another TeraStation.

Note: A separate surveillance server license pack must be purchased to do this.

- Click *Start - BUFFALO - BUFFALO Surveillance Server - Data Service Policies*.
For Windows 8.1 and Windows 8, click *Data Service Policies* in the Start menu.
- Click  and when the Create a Policy screen is opened, enter "MigrateTest" into the "Policy Name" field, select "Migrate", and click OK.

A screenshot of a 'Create a Policy' dialog box. It has a light beige background and contains the following elements: a 'Policy Name' label above a text input field; a 'Description' label above a text input field; a 'Policy Type' section with three radio button options: 'Migrate' (which is selected), 'Duplicate', and 'Purge'; a checked checkbox labeled 'Active'; and three buttons at the bottom: 'OK', 'Cancel', and 'Help'.

- Click the *Source* tab. Under "Vault", select the TeraStation where the recorded video data is saved. Select "Any" to migrate recorded data on all network-connected TeraStations.

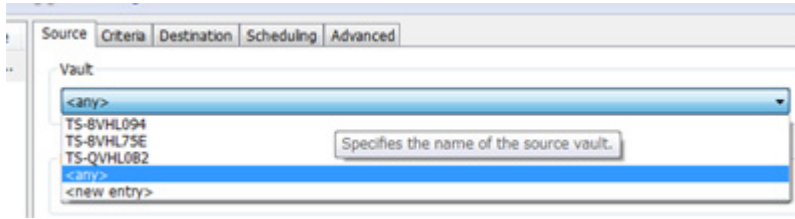

- Click the *Destination* tab to select which TeraStation you want to move the data from "Vault" off of.

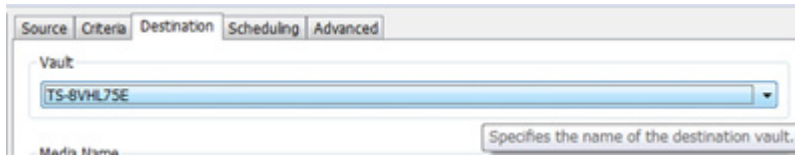

- Set the migration date and time on the *Scheduling* tab. To execute migration every hour, select "Repeatedly at a defined interval" and "Every 1 hour".

- Click  and register the policy.

This completes the settings for moving recorded video to another TeraStation.

Backing Up Recorded Video to Another TeraStation

Follow this procedure to back up recorded video data to another TeraStation.

Note: A separate surveillance camera license pack must be purchased to do this.

- Click *Start - BUFFALO - BUFFALO Surveillance Server - Data Service Policies*.
For Windows 8.1 and Windows 8, click *Data Service Policies* in the Start menu.

- Click  and when the Create a Policy screen opens, enter "DuplicateTest" into the "Policy Name" field, select "Duplicate", and click *OK*.

Policy Name

Description

Policy Type

Migrate

Duplicate

Purge

Active

OK Cancel Help

- 3 Click the *Source* tab and select the TeraStation where the recorded video data is saved under "Vault".

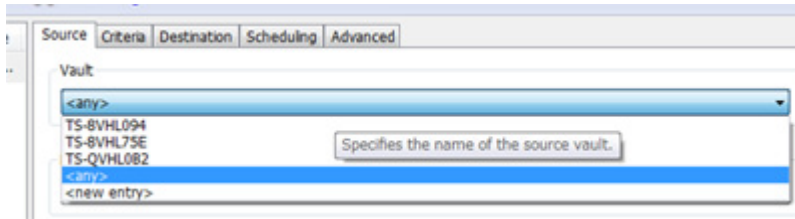

Note: If "any" is selected, recorded data for all TeraStations connected to the network will be backed up. Click the *Destination* tab, then select the TeraStation where you want to move the data from "Vault".

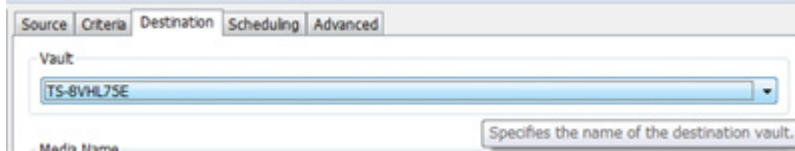

- 4 Set the job execution date and time from the *Scheduling* tab. In this example, to execute the backup job every hour, select "Repeatedly at a defined interval" and "Every 1 hour".

- 5 Click  and register the policy.

This completes the settings for backing up video to another TeraStation.

Automatically Delete Old Data when Space is Low

Follow the procedure below to delete (purge) recorded video starting from the oldest when available space for recording video becomes low.

Note: By default, old video data will be deleted automatically when 80% of available space is used. Old data will be removed at the same rate as new video is added, so there will always be enough video to fill about 80% of the total available space. To disable this setting, remove the "Remove Old Video" policy from "Data Service Policies".

- 1 Click *Start - BUFFALO - BUFFALO Surveillance Server - Data Service Policies*.
For Windows 8.1 and Windows 8, click *Data Service Policies* in the Start menu.

- 2 Click  and when the Create a Policy screen is opened, enter "PurgeTest" into the "Policy Name" field, select "Purge", and click OK.

Policy Name

Description

Policy Type

Migrate

Duplicate

Purge

Active

OK Cancel Help

- 3** Click the *Source* tab and select the TeraStation on which recorded video is saved under "Vault".

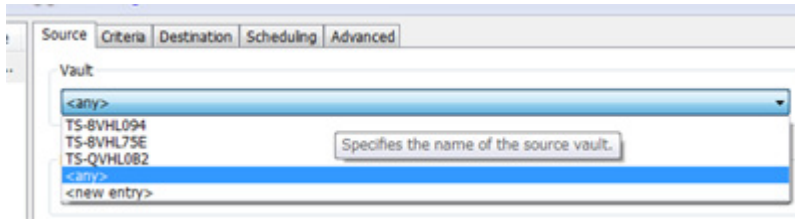

- 4** Open the *Criteria* tab; under "Miscellaneous Options", set "Watermark: High" and "Watermark: Low" options. This determines the used space threshold.

For example, if you set Watermark: High to "80" and Watermark: Low to "40", old data will be deleted when the amount of used space exceeds 80% until it drops to 40%.

- 5** Set the job execution date and time from the *Scheduling* tab. In this example, we'll configure a job to execute at 2:00 AM on weekdays.

- Select "On selected days each week".

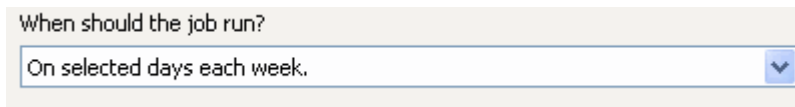

- Select every day between Monday and Friday.

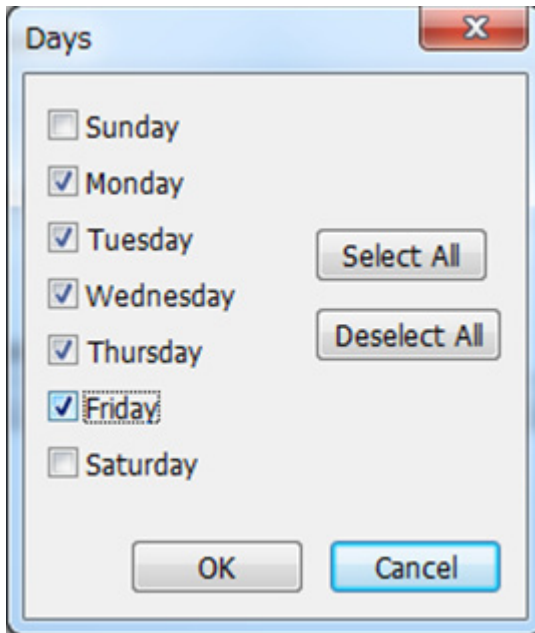

- Select "2:00" and "AM", then click OK.

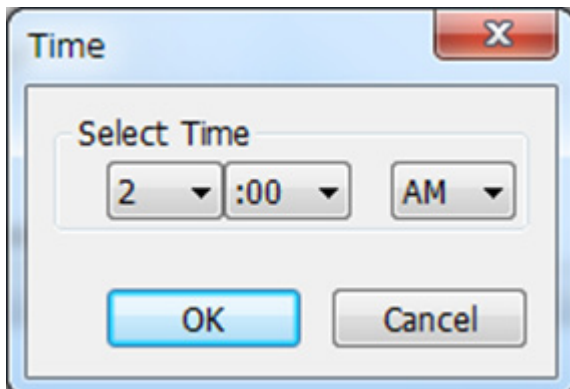

- 6** Click  and register the policy.

This completes the registration of the policy. The job is executed at 2:00 AM Monday to Friday.

Changing Where Recorded Video Is Saved

Follow this procedure to change the TeraStation to which video is saved.

- 1 Click *Start - BUFFALO - BUFFALO Surveillance Server - Camera Policies*.
For Windows 8.1 and Windows 8, click *Camera Policies* in the Start menu.
- 2 Click the  icon on the tool bar and open the "Camera Configurations" screen.
- 3 Double-click the camera for which video will be saved. This opens "Modify Camera".

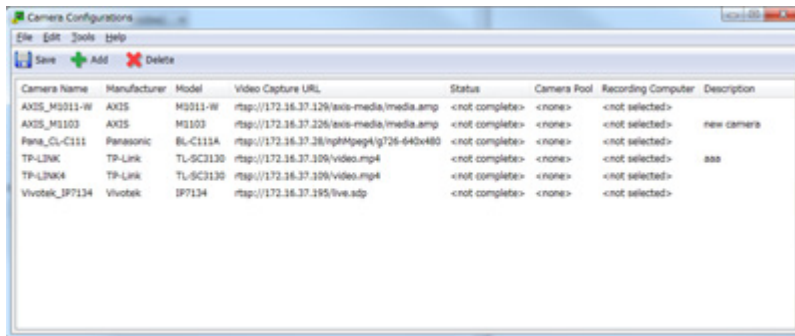

Camera Name	Manufacturer	Model	Video Capture URL	Status	Camera Pool	Recording Computer	Description
AXIS_M1011-W	AXIS	M1011-W	rtsp://172.16.37.129/axis-media/media.amp	<not complete>	<none>	<not selected>	
AXIS_M1103	AXIS	M1103	rtsp://172.16.37.226/axis-media/media.amp	<not complete>	<none>	<not selected>	new camera
Pana_C1111	Panasonic	BL-C111A	rtsp://172.16.37.38/inghMpeg4/g726-640x480	<not complete>	<none>	<not selected>	
TP-LINK	TP-Link	TL-SC130	rtsp://172.16.37.309/Video.mp4	<not complete>	<none>	<not selected>	aaa
TP-LINK4	TP-Link	TL-SC130	rtsp://172.16.37.309/Video.mp4	<not complete>	<none>	<not selected>	
Vivotek_IP7134	Vivotek	IP7134	rtsp://172.16.37.195/live.sdp	<not complete>	<none>	<not selected>	

- 4 Change the TeraStation you want to use as the "Recording Computer" and click *OK*.

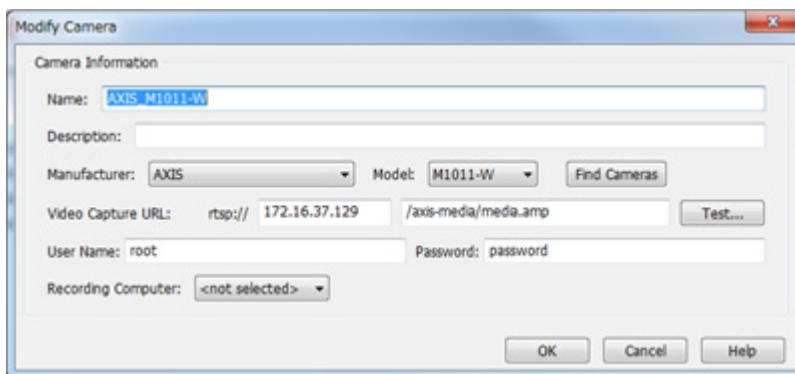

Modify Camera

Camera Information

Name:

Description:

Manufacturer: Model:

Video Capture URL:

User Name: Password:

Recording Computer:

- 5 Click  and register the policy.

This completes changing the TeraStation where recorded video is saved.

Email Notification

You may configure the TeraStation to send you an email notification when the available space for recording is low, or if recording fails due to a camera malfunction, network disconnection, or other cause.

Client Tools

Camera Policies

Camera Policies is utility software that registers the network cameras and starts video recording.



Click  to start a wizard to register network cameras and schedule recording.

Click  to open the camera configuration screen where network cameras are registered.

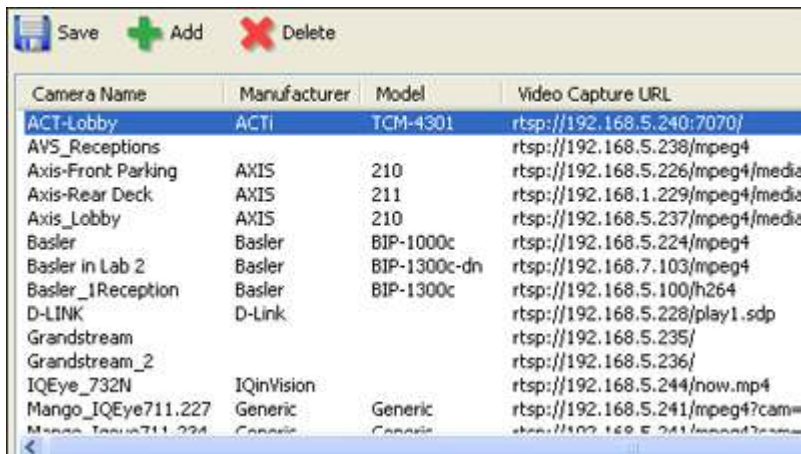

Click  to start a new registration screen for an additional network camera. You can also register the camera and define the recording video policy.

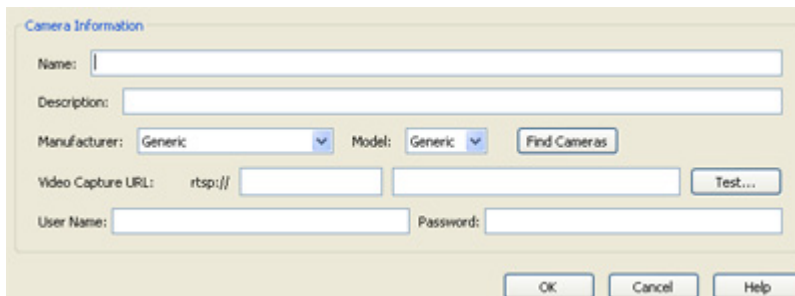

Live Viewer

Live Viewer allows you to view video currently being recorded by a network camera.

Note: To view the current video, the network camera must be registered in Camera Policies.

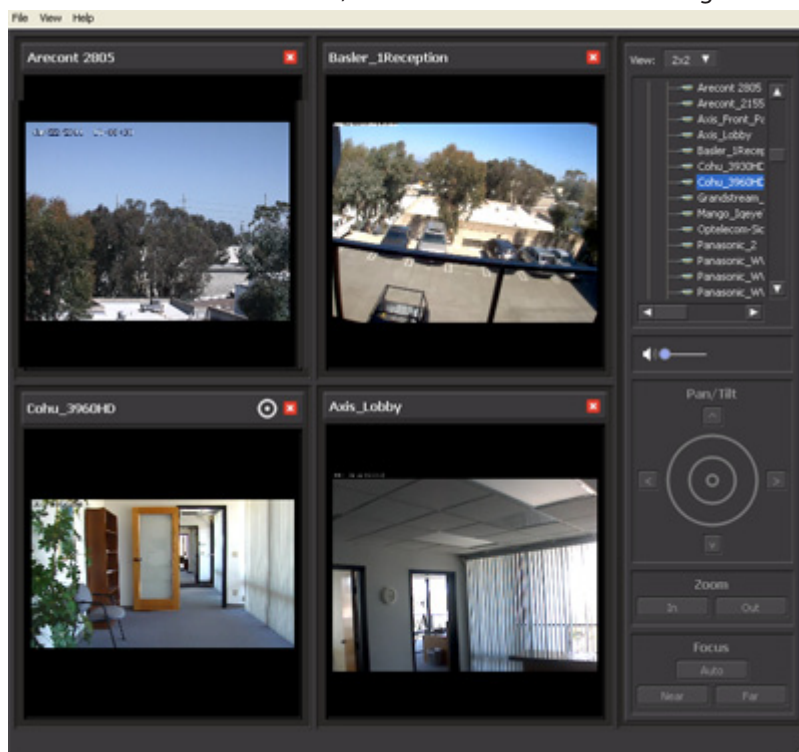

- The layout of the camera view (numbers of rows and columns) and registered network cameras are displayed in the panel on the right side of the screen.
- The camera view (live video) is displayed on the left side panel. In the default setting, a 2x2 camera view is displayed. A layout view with up to 4x4 cameras can be displayed.
- Double-clicking the network camera name or dragging to the camera view frame enables viewing of the current video that is being recorded by the network camera.

The layout can be saved in *View - Save Layout As*.

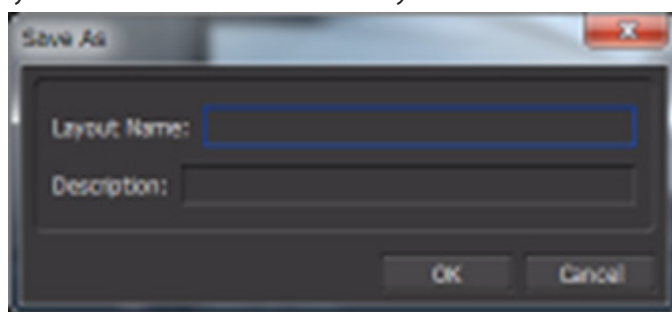

Data Service Policies

Data Service Policies is utility software for creating data service policies. The policy types that can be created are shown below.

Note: To use migration and duplication, a separate backup license must be purchased.

Policy Type	Action
Migration	Moves recorded video data to another TeraStation
Duplication	Copies recorded video data to another TeraStation and synchronizes the data.

Policy Type	Action
Purge	Deletes the recorded video data.

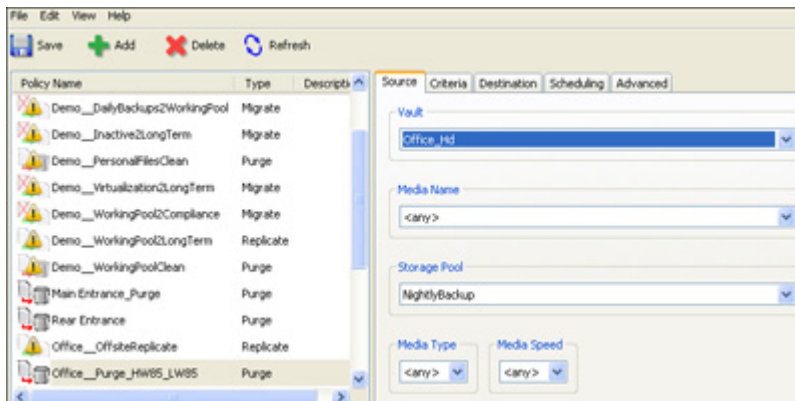

The right side of the screen includes tools for creating and updating data service policies. The left side of the screen shows an overview of all data service policies.

Notes:

- If  is displayed for a policy in the left-side frame, the policy is disabled.
- Surveillance server functionality must be enabled beforehand for the TeraStation where migration or duplication files will be saved.

Vault Admin



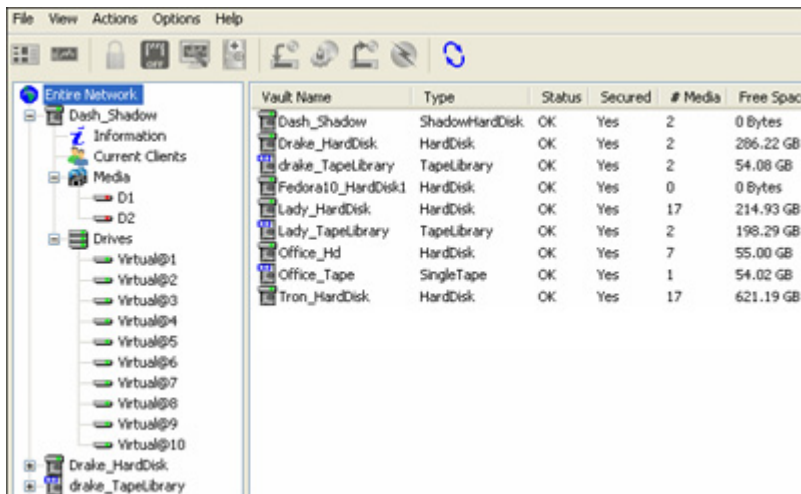

Vault Admin is utility software for managing surveillance camera resources.







Operations are performed from the tool bar located in the top section of the screen.



The icons and their functions are shown below.

Icon	Description
	Starts "Mini Vault Stats" for enabling the display of basic monitoring information.
	Sets the security status.
	Shuts down or restarts a portion (Vault) of the surveillance cameras.
	Changes the properties.
	Performs a diagnosis of the surveillance camera.

Icon	Description
	Loads a media device.
	Prepares a media device.
	Unloads a media device.
	Erases a media device.
	Refreshes the current screen.

Surveillance Video Manager

Surveillance Video Manager is utility software for performing searches and exporting recorded video data.

Search Window

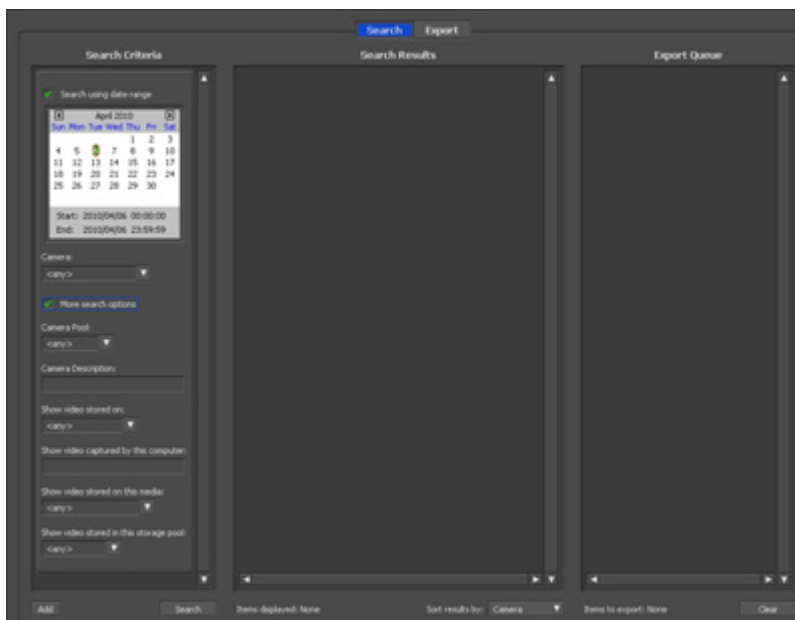

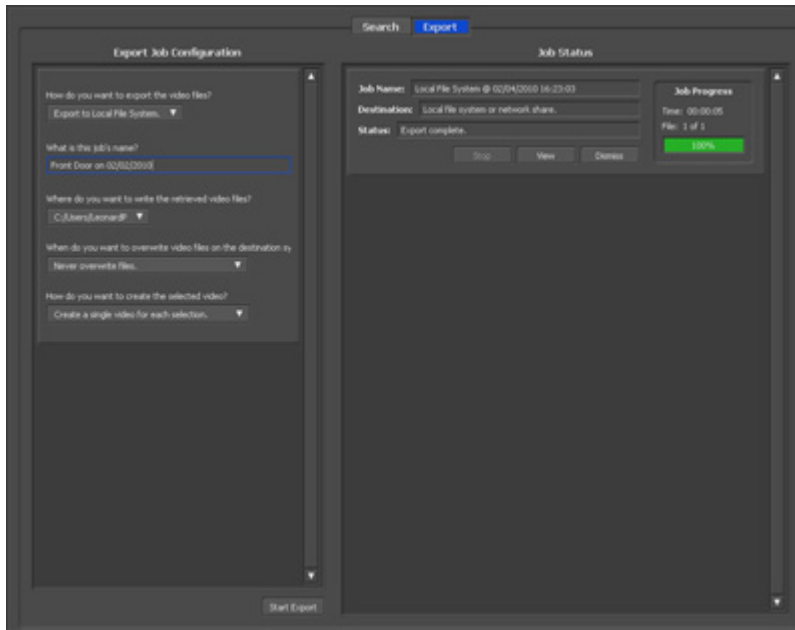

Export Window

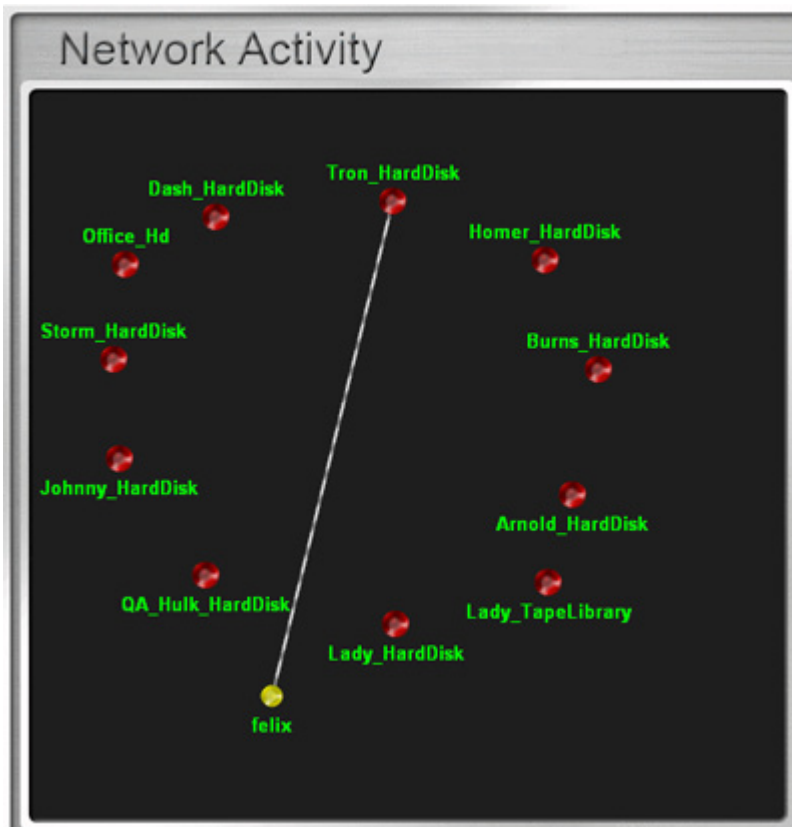

Network Activity

Network Activity is utility software that displays the TeraStations on which surveillance cameras are operating on the network in real time and in graphical form.



All clients and TeraStations located on the network are indicated by  and labels. These can be moved by dragging and dropping them. Clients are displayed only when a job is being executed and activities are indicated by a line linking the client and TeraStation.

Mini Vault Stats

Double-clicking the icon for a TeraStation on "Network Activity" starts "Mini Vault Stats". "Mini Vault Stats" shows the network traffic in graphical form.

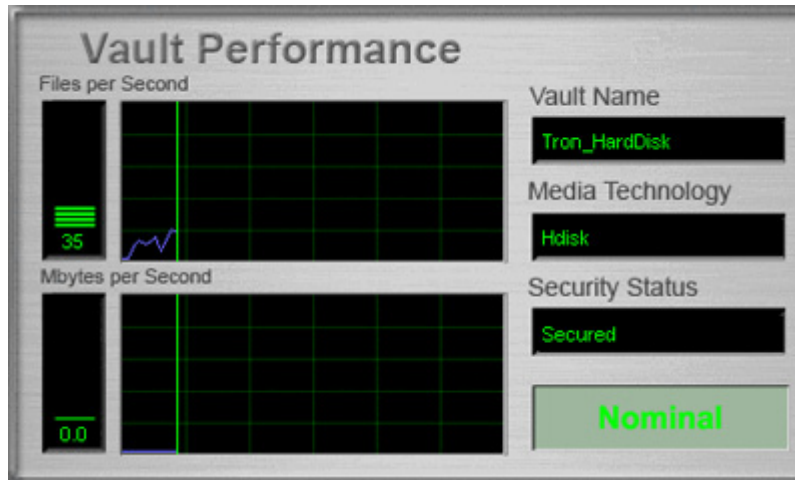

Activating Additional Licenses

Purchasing an additional license (sold separately) enables you to connect and use two or more cameras and use the migration and duplication functions. Use this procedure to activate an additional license.

When the TeraStation is Connected to the Internet

- 1 Click *Start - BUFFALO - BUFFALO Surveillance Server - Vault Admin*.
For Windows 8.1 and Windows 8, click *Vault Admin* in the Start menu.
- 2 Select the TeraStation to which you want to add the license, right-click it, and click *Properties*.

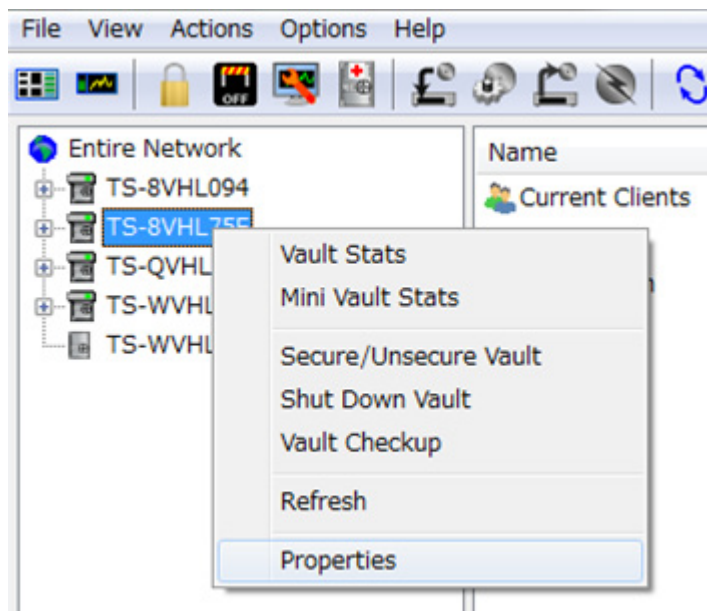

3 Open the *License* tab, then click +.

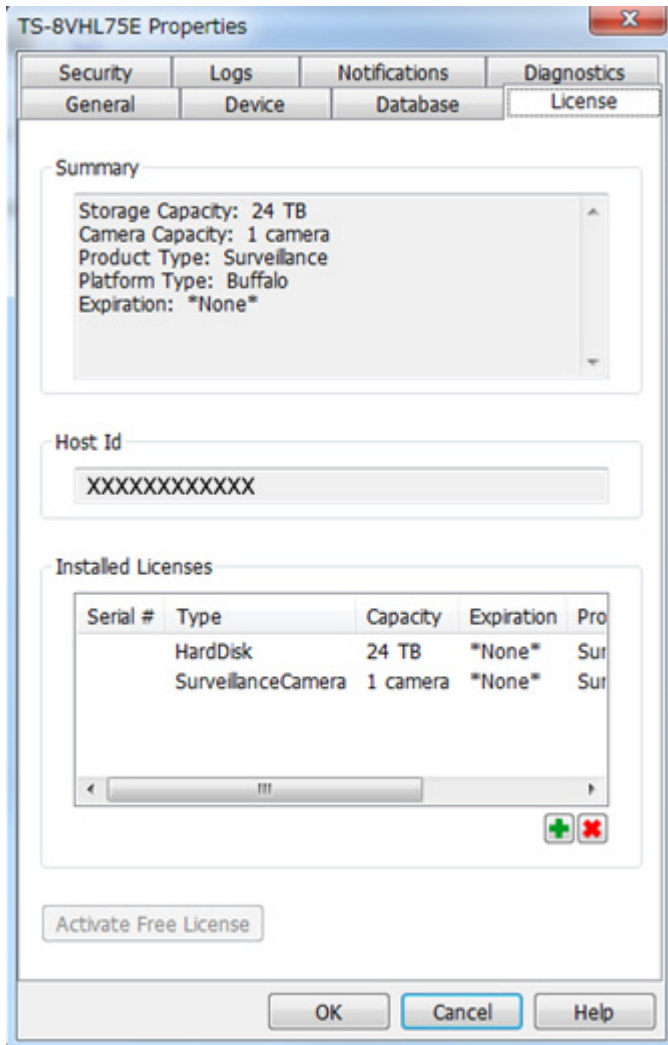

If your default free license activation is not installed, see the "Enabling the Free License" section to install it.

4 Enter the product key for the license pack (sold separately), then click *OK*.

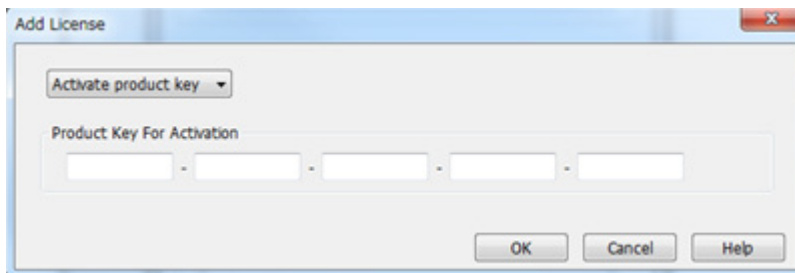

- 5** Confirm that the new license was added to "Installed License".

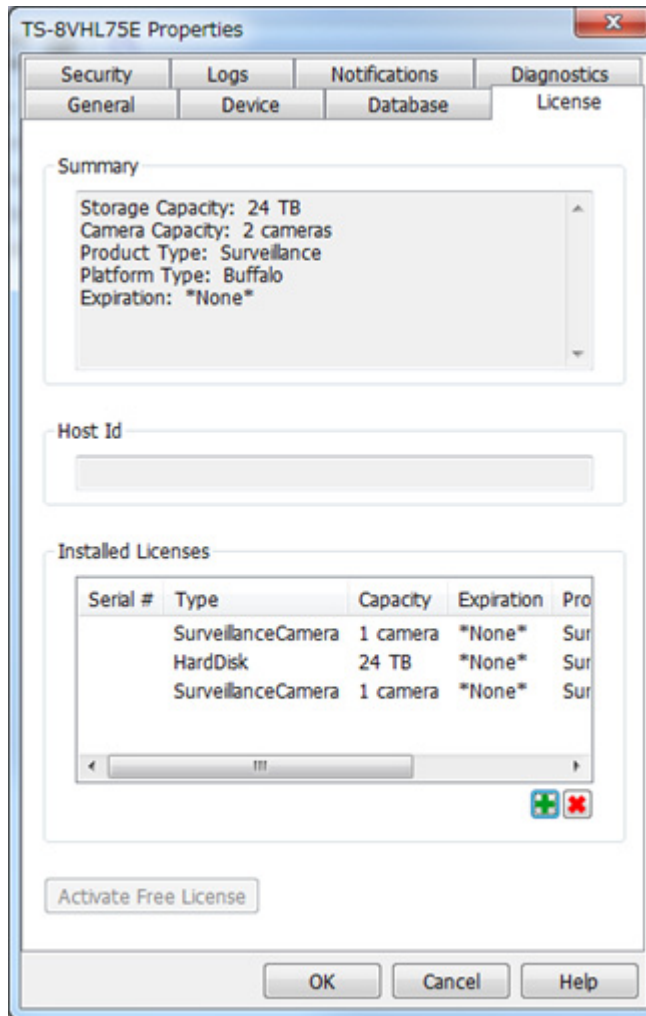

You have now activated the additional license.

TeraStation Not Connected to the Internet

- 1** If the TeraStation is being used in an environment where Internet access is not available, a separate computer with access to the Internet is required to activate the additional license.
- 2** Click *Start - BUFFALO - BUFFALO Surveillance Server - Vault Admin*.
For Windows 8.1 and Windows 8, click *Vault Admin* in the Start menu.

- 3 Select the TeraStation where you want to add the license, right-click it, and click *Properties*.

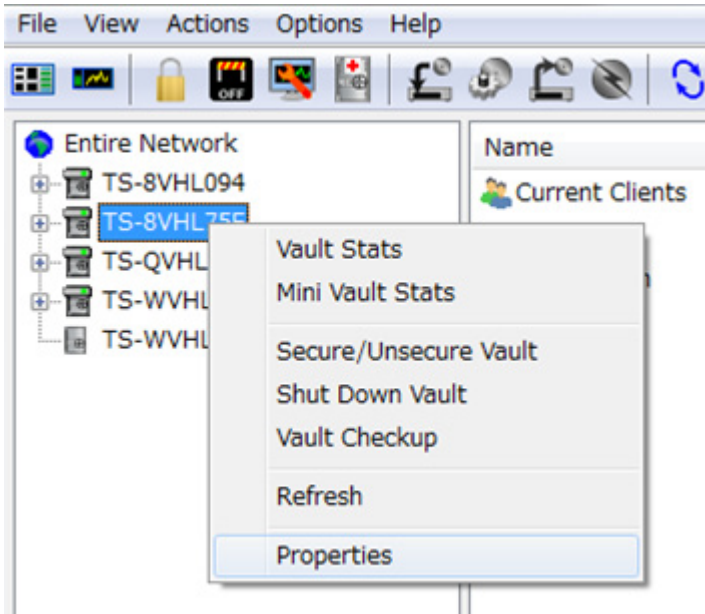

- 4 Open the *License* tab, then make a note of the "Host Id".

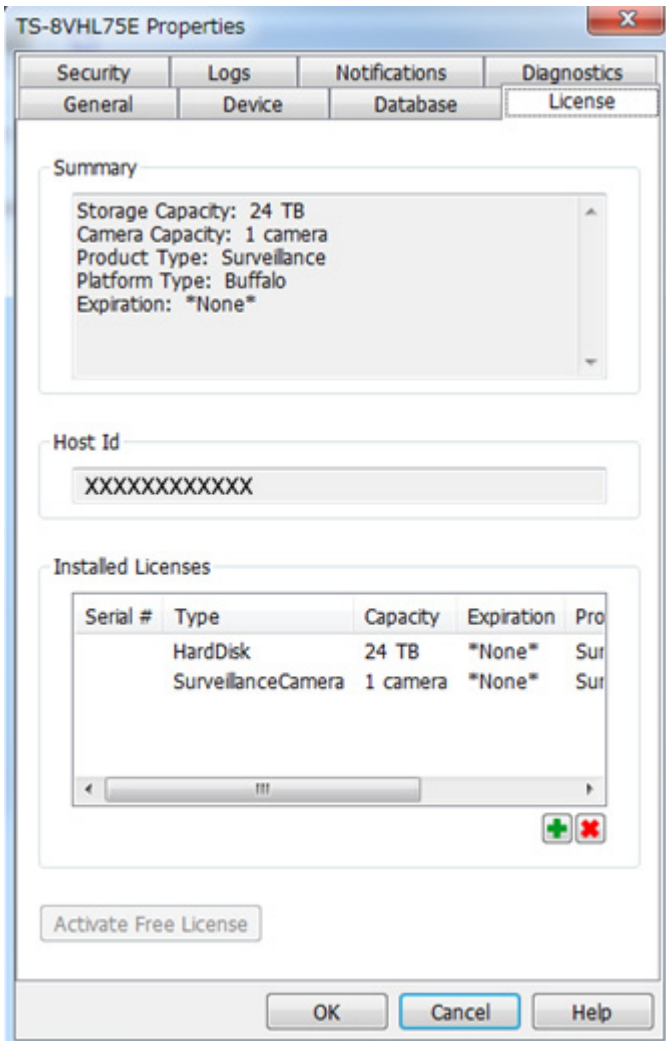

- 5 Open the website in web browser: http://buffalo.jp/support_s/camera_licence/.

- 6 From the license pack (sold separately), enter the product key and host ID code and click "Activate Software License".

Indicates a required field

Activate Buffalo Surveillance Server Software

By filling out the product key and registration information below, you will receive a valid license file to manually activate your Buffalo Surveillance Server software. The license file will then need to be imported into the software using the Buffalo Surveillance Server Vault administrator application.

NOTICE: You should *only* need to complete this process below if you are unable to activate your software directly from the Phoenix Vault Administrator application.

Product Key Information

Please enter your Product Key as XXXXX XXXXX XXXXX XXXXX XXXXX

Product Key: - - - -

Your Host ID number is obtained from the License Properties tab within the Vault Administration application.

Host ID Code: 

I have read and Accept the [Software Application Terms and Conditions](#)

Activate Software License

- 7 Downloading of the license file (*.lic) begins. Save the license file to a USB memory drive or other storage device.
- 8 Copy the license file to a computer connected to the same network as the TeraStation.
- 9 In the computer connected to the same network as the TeraStation, click *Start - BUFFALO - BUFFALO Surveillance Server - Vault Admin*.
For Windows 8.1 and Windows 8, click *Vault Admin* in the Start menu.
- 10 Select the TeraStation to which you want to add the license, right-click, and click *Properties*.

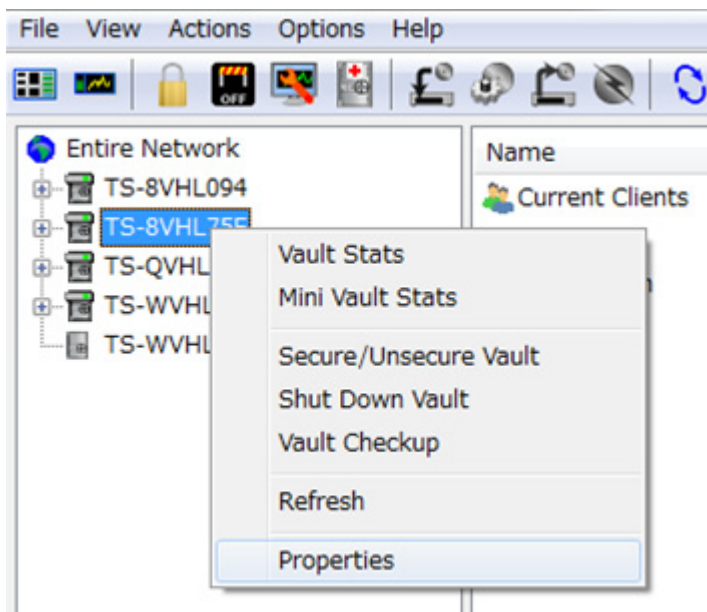

11 Open the *License* tab, then click +.

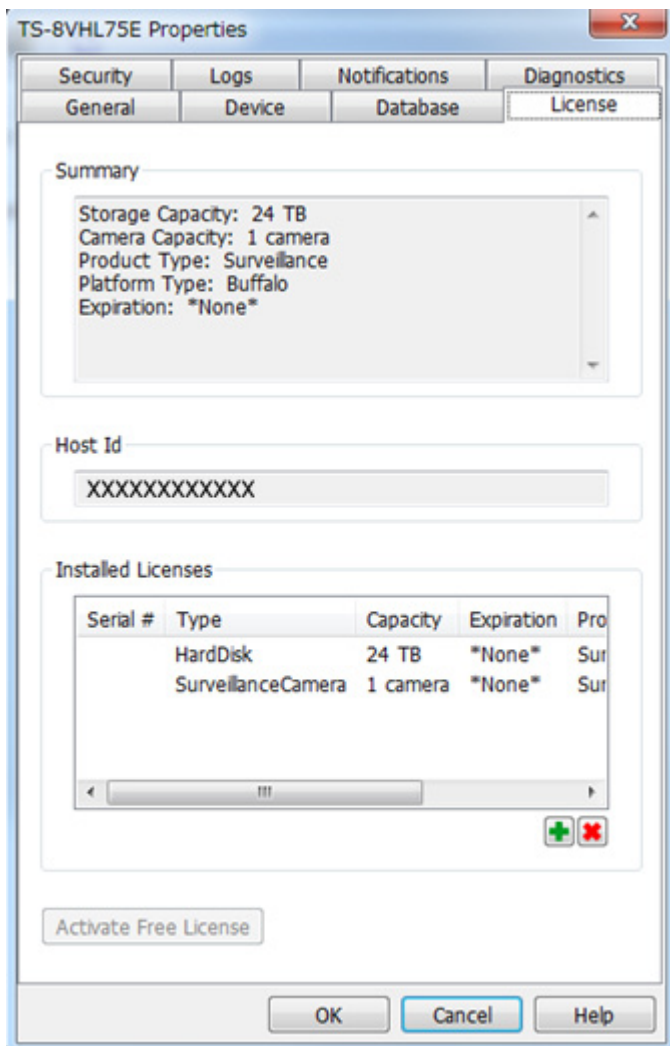

12 Select "Import license file", then click *Browse*.

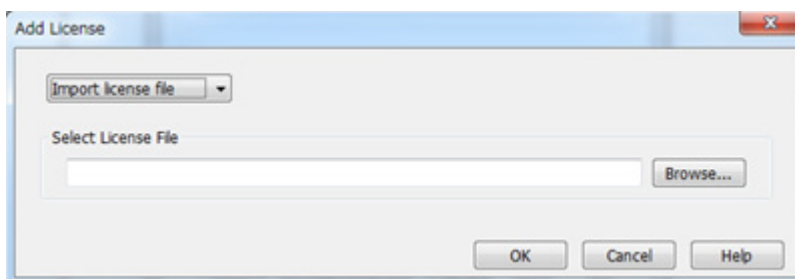

13 Select the license file that was saved before, then click *OK*.

14 Check that the license pack was added to "Installed Licenses".

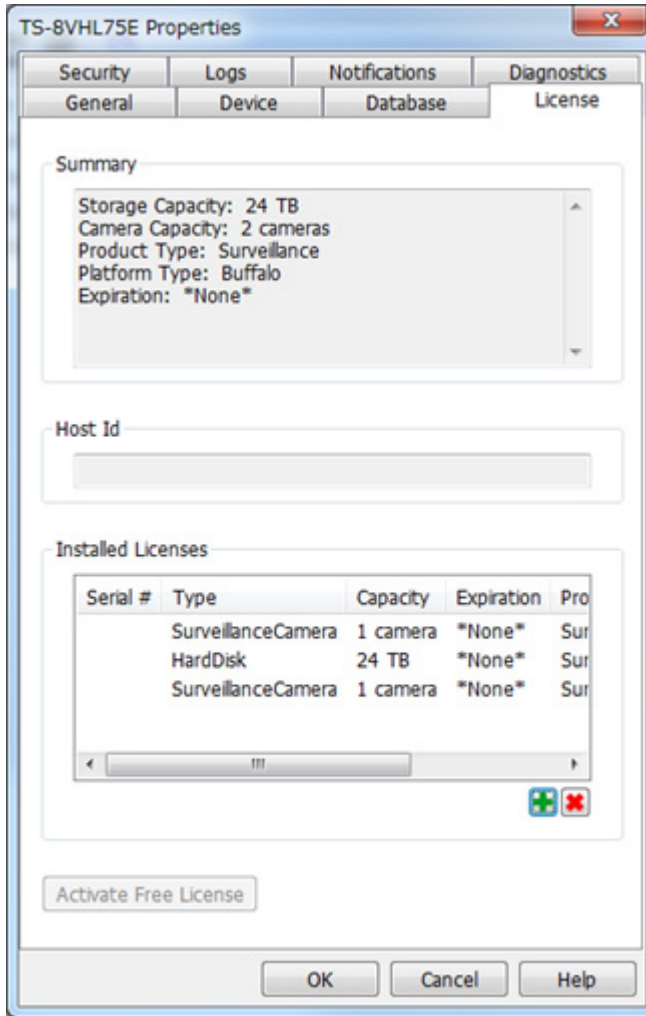

This completes authentication of an additional license.

Troubleshooting

Issue	Possible Cause	Possible Solution
Video recording does not start.	Surveillance Camera setting not enabled.	Enable surveillance camera in Settings.
	A LAN cable between the TeraStation and network camera is disconnected, or the power is turned off.	Check that the LAN cables are inserted correctly.
	The video recording policy is not registered.	Register the video recording policy from Camera Policies.
	The device is not connected to a network on the same LAN, or the device is not connected to the LAN port that was set in Settings.	Connect the device to the network of the LAN port that was set in Settings.
	The disk is full.	Free available space on the disk by moving or deleting files.
	The time for the TeraStation and network camera is not correct.	Set the time in Settings.
	There are not enough camera licenses for the network cameras.	Purchase and register an additional license.

Issue	Possible Cause	Possible Solution
I cannot enable the surveillance camera.	Failover is running.	Disable failover.
Surveillance cameras no longer record video.	The target shared folder for the recorded video was deleted.	Enable surveillance camera functionality in Settings.
I cannot view the network camera using Live Viewer.	The network camera is not registered in some camera policies.	Register the network camera from camera policies.
	There is an error in the network camera settings.	Verify the settings in the camera policies.
There is no recorded data, or the recorded data cannot be found.	A camera was added in camera policies while Surveillance Video Manager was running.	If this is the case, this video may not be accessible. Restart Surveillance Video Manager to enable searching for recorded video from the new camera.

Notes:

- QuickTime is a trademark of Apple Inc., registered in the U.S. and other countries.
- VLC media player is a trademark of Video LAN org.
- See the Buffalo website for supported cameras.
- Refer to the "Buffalo Surveillance Server Administrator's Guide" available from the Buffalo website for information about client tools.

Chapter 10 Advanced Features

Antivirus Software

Trend Micro NAS Security™ can protect your network and data from software viruses, malware, and spyware. To use Trend Micro NAS software, purchase an OP-TSVC license pack (sold separately). If your TeraStation includes activated antivirus software, no license registration is necessary.

Notes:

- To use the antivirus software effectively, the TeraStation should be connected to the Internet. The connection can be routed through a proxy server if the appropriate settings are configured in *Administration - Proxy Settings* from the left-side menu of the Trend Micro NAS Security settings page.
- Trend Micro is a registered trademark of Trend Micro Incorporated.

Licenses

If the antivirus software on your TeraStation is not activated or has expired, please purchase an OP-TSVC license pack (sold separately). If your TeraStation includes activated antivirus software, no license registration is necessary. The total period for antivirus software updates may be extended up to 5 years.

This example shows an initial 1-year period for updates extended by an additional year.

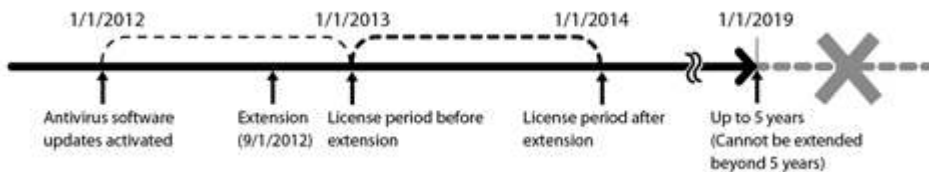

Note: It's not possible to register a serial number that would extend the total license period beyond 5 years, such as a second 3-year license after 3 years.

- 1 From the left-side menu, click *Administration - Product License*.

The screenshot shows the Trend Micro NAS interface. The left-side menu is expanded to show 'Administration - Product License'. The main content area displays the 'Summary' page, which includes 'System Information (2)', 'Product version:', 'Scan Results for Virus', and a list of scan results: 'Virus uncleanable' and 'Virus quarantined'.

- 2 Enter the serial number from the "Trend Micro NAS Security™ License Pack Guide", included in your package. Click *Activate*.

Product License Help

Please enter the new serial number to activate your product.

New Serial Number

Product: Trend Micro NAS Security 1.0

Current serial number: abcd - abcd - abcd - abcd - abcd

New serial number: - - - -

The new license is now registered.

To check the status of the current license, open the Trend Micro NAS Security settings page and navigate to *Administration - Product License* on the left-side menu.

Activating Virus Scanning

Follow the procedure below to activate virus scanning.

- 1 In Settings, click *Applications*.

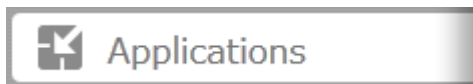

- 2 Move the antivirus switch to the  position.

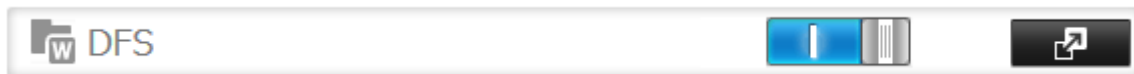

A quarantine folder named "TMNAS" is automatically created on the TeraStation. If a virus is detected, viruses are moved to this folder.

Configuring Security Settings

To configure Trend Micro NAS Security, follow this procedure.

- 1 In Settings, click *Applications*.

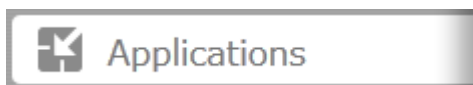

- 2 Click  to the right of "Antivirus".

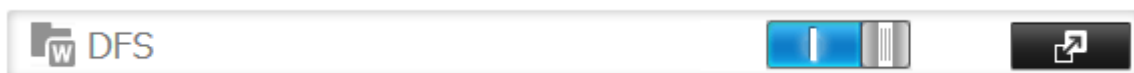

- 3 Click *Options*.

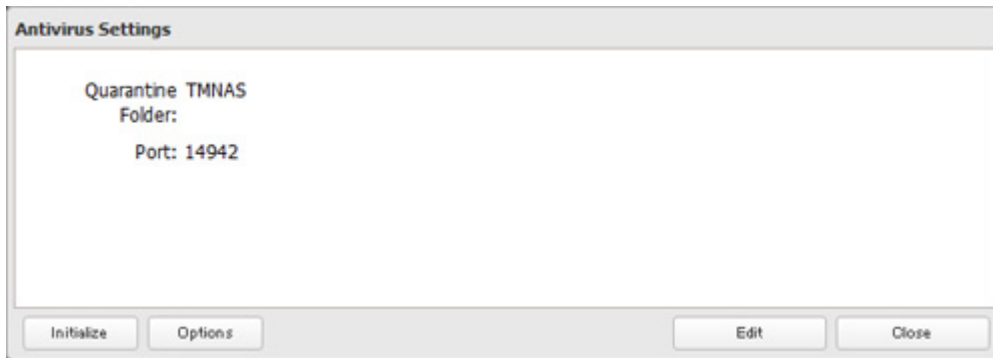

- 4 Enter your username and password, then click *Log On*.

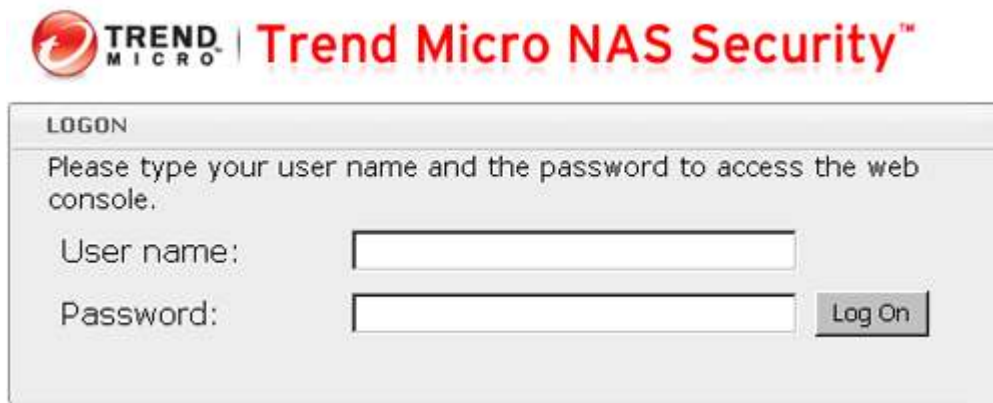

You can log on with the TeraStation's admin account. The default username and password are "admin" and "password".

- 5 Trend Micro NAS Security settings will open.

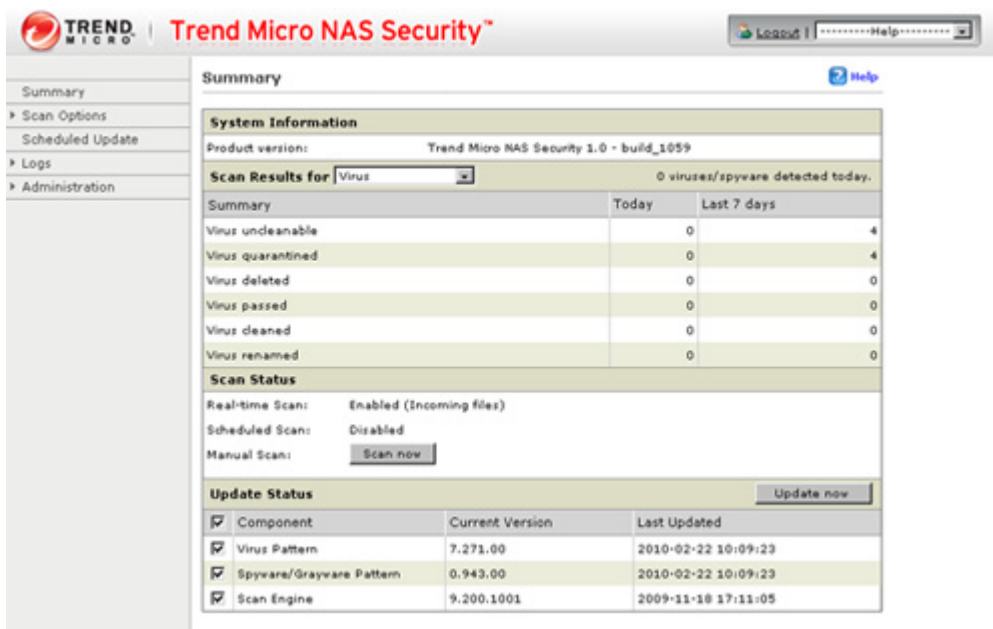

Note: The Trend Micro NAS Security settings page is compatible with IE 6.0 SP2 or later (Windows) and Firefox 1.5 or later (Windows or Mac).

Connecting through a Proxy Server

If you must pass through a proxy server to connect to the Internet in your network environment, follow this procedure to set the IP address of the proxy server and other settings.

- 1 From the left-side menu, click *Administration - Proxy Settings*.

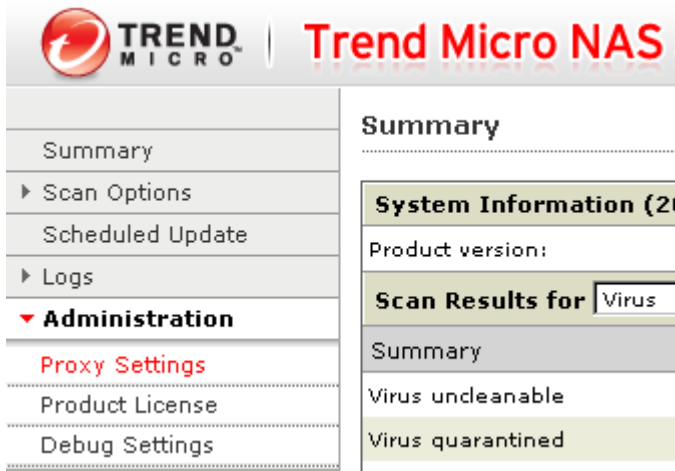

- 2 Check "Use a proxy server to access the Internet (License update)". Enter the IP address and port of the proxy server, then click *Save*.

Proxy Settings

The 'Proxy Settings' dialog box has two tabs: 'General' (selected) and 'Component Update'. Under the 'General' tab, there is a checked checkbox labeled 'Use a proxy server to access the Internet (License update)'. Below this are several input fields: 'Server name or IP address:', 'Port:', 'Proxy server authentication', 'User name:', and 'Password:'. At the bottom of the dialog are 'Save' and 'Cancel' buttons.

The antivirus software is now configured to use a proxy server.

Updating

For best results, configure your antivirus software to update automatically as described below.

- 1 From the left-side menu, choose *Scheduled Updates*.



2 Check "Enable Scheduled Update".

Scheduled Update Help

Enable Scheduled Update

Update Frequency

Start time: 00 : 00 (hh:mm)

Repeat interval: Hourly
 Daily, update for 2 hours

3 Select a time for updates to begin, an interval for updates, and an amount of time for updates to continue. Select the components to update. Click *Save*.

Scheduled Update Help

Enable Scheduled Update

Update Frequency

Start time: 12 : 00 (hh:mm)

Repeat interval: Hourly
 Daily, update for 2 hours
 Weekly, every Monday
update for: 4 hours

Components to Update

<input checked="" type="checkbox"/>	Component	Current Version	Last Updated
<input checked="" type="checkbox"/>	Virus Pattern	7.271.00	2010-02-22 10:09:23
<input checked="" type="checkbox"/>	Spyware/Grayware Pattern	0.943.00	2010-02-22 10:09:23
<input checked="" type="checkbox"/>	Scan Engine	9.200.1001	2009-11-18 17:11:05

The antivirus software is now configured to update automatically at the scheduled time. Updates will not be downloaded if the TeraStation is turned off, in standby mode, or disconnected from the Internet.

Excluding a Specific Folder from Antivirus Scanning

By default, all folders on the TeraStation (including attached USB drives) will be scanned. Follow the procedure below to block specific shared folders from being scanned.

1 In Settings, navigate to *File Sharing - Folder Setup*.

Folder Setup 4 Folder(s) Close

2 Click the shared folder that you want to remove from the scan, then click *Edit*.

3 Uncheck items to exclude from the scan, then click *OK*.

Virus Scan: Real Time Scan
 Scheduled Scan
 Manual Scan

Virus Scanning

Three types of virus scans are available:

Real-time Scan

The virus scan runs in the background, scanning every file that you read or write. This is the default type of scanning. Your TeraStation may run slower if real-time scanning is enabled.

Scheduled Scan

A scheduled scan is executed at specific regular intervals, such as every Tuesday at 3 am.

Manual Scan

A manual scan runs once when initiated. Initiate a manual scan as described below.

- 1 From the left-side menu, choose *Scan Options - Manual Scan*.



- 2 Click *Scan now*.

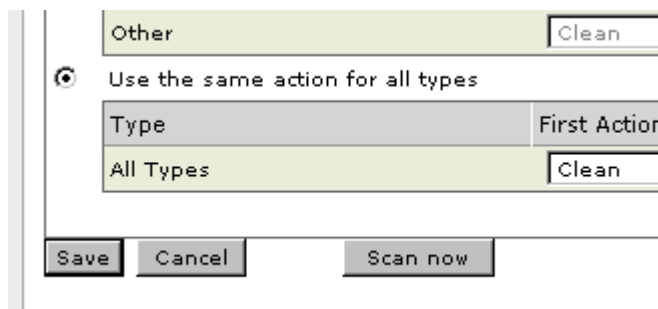

This starts the virus scan.

If the scan finds a virus, the user can be notified in two ways:

- The I34 virus alert message is normally shown on the LCD panel. Once the virus is removed from the quarantine folder, the message is no longer displayed. If the antivirus software is configured to delete viruses from the quarantine folder automatically, then the I34 virus alert message will not be displayed.
- If email notification is enabled in Settings, then the antivirus software notifies the user by email if a virus is found. Enabling email notifications is recommended.

Depending on how many files are on your TeraStation, a virus scan may take several hours. Estimated scanning times are shown below.

- 10,000 files: ~ 30 minutes
- 100,000 files: ~ 5 hours
- 1,000,000 files: ~ 50 hours

Checking the Log

Follow the procedure below to check the virus scan log.

- 1 From the left-side menu, choose "Logs".



- 2 Click the log item that you want to check.

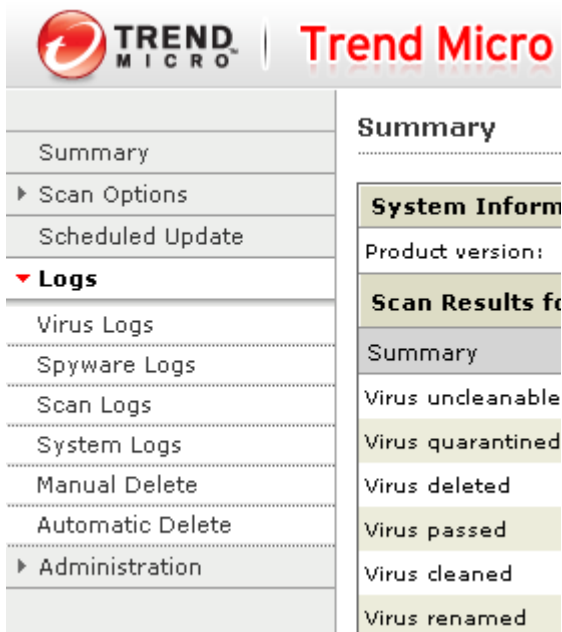

- 3 Click *Display Log*.

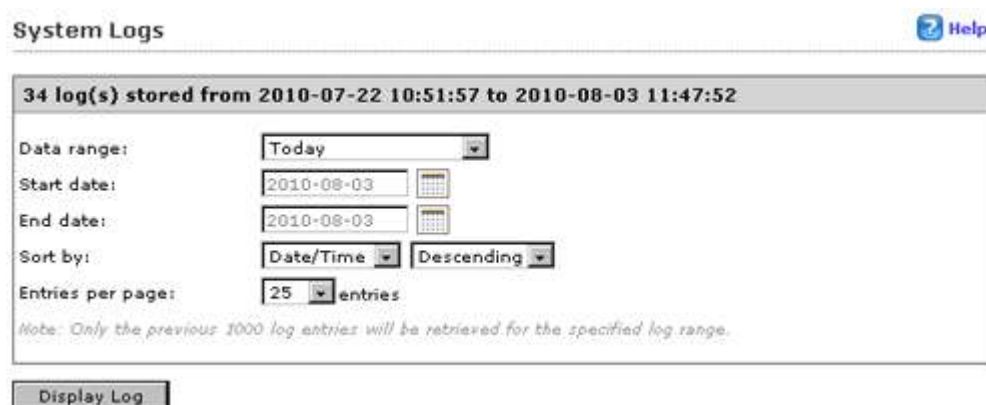

This completes the procedure for checking the log.

Online Help

For more information on the antivirus software, refer to the online help. Follow the procedure below to access the online help.

- 1 From the right-top menu, choose *Help - Contents and Index*.

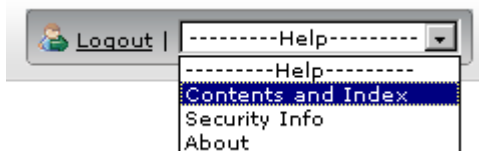

- 2 Online help will open.

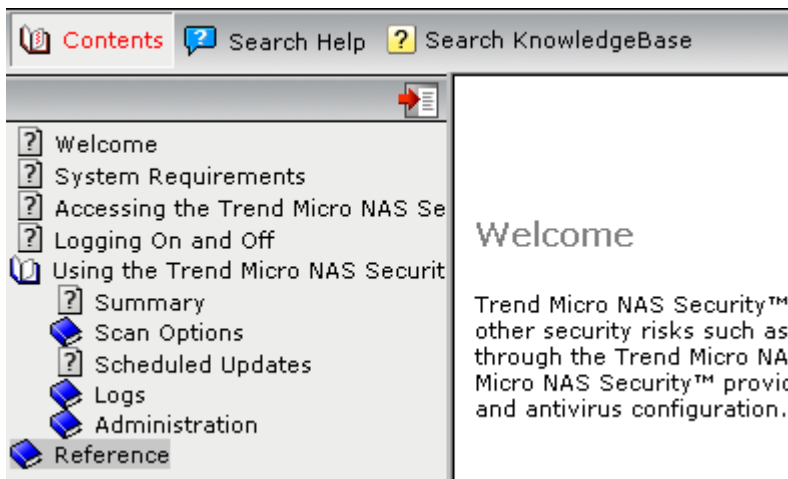

Online help is now ready to use.

Email Notification

Your TeraStation can send you email reports daily, or when settings are changed or an error occurs. Notification emails may be triggered by any of the following events:

- Scheduled hard drive status notification (includes quota exceeded notification)
- Backup jobs
- RAID error
- Fan error
- Hard drive read error
- Hard drive replacement
- RAID configuration change
- System bootup/shutdown

- 1 In Settings, click *Management*.

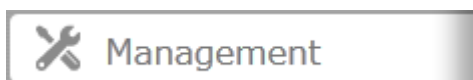

- 2 Move the email notification switch to the  position to enable email notification.



- 3 Click  to the right of "Email Notification".

- 4 Click *Edit*.

- 5** Enter your mail server settings and choose which events will trigger notifications. Click *OK* to send a test email.

The screenshot shows the 'Email Notification' configuration window. It includes fields for SMTP Server Address, SMTP Port (25), Authentication Type (Disable), POP3 Server Address, POP3 Port (110), SSL/TLS (Disable), Username, Password, and Subject (TeraStation Status Report). There are buttons for 'Add', 'Delete', and 'Select from List' for recipients. A table for recipients is shown with columns for Name, Recipient(s), and Class. Below the table are 'Select All' and 'Unselect All' buttons. At the bottom, there are checkboxes for reports: HDD status report (checked), Fan error (checked), Disk error (checked), Backup complete (checked), Quota report (checked), and System alert (checked). The 'HDD status report' checkbox has a dropdown set to '00' and the unit 'Hour'. 'OK' and 'Cancel' buttons are at the bottom right.

Sleep Mode

To save energy, you can specify times to put the TeraStation into sleep (standby) mode, during which the hard drive and LEDs are turned off.

- 1** In Settings, click *Management*.

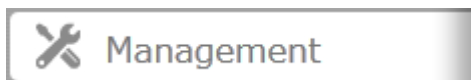

- 2** Click  to the right of "Sleep Timer".

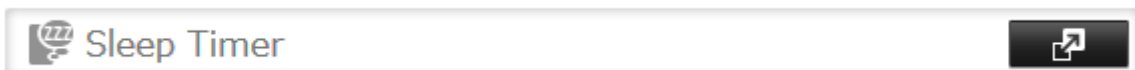

- 3** Click *Edit*.

4 Specify the timer interval, wake-up time, and time to go into sleep mode, then click OK.

The screenshot shows the 'Sleep Timer Settings' dialog box. It contains three sections for 'Timer 1', 'Timer 2', and 'Timer 3'. Each section has a 'Schedule' dropdown menu, a row of checkboxes for days of the week, and two time pickers for 'Wake Up at' and 'Begin Sleep at'. Timer 1 is active with a weekly schedule on Mon-Wed, waking at 07:00 and sleeping at 22:00. Timers 2 and 3 are disabled.

Notes:

- Up to three timers can be set.
- The time to enter sleep mode can be set from 0:00 am to 3:45 of the next day.
The time to wake from sleep mode can be set from 0:00 to 23:45.
If the time to enter sleep mode is after 24:00, the wake-up time setting may be from 4:00 to 23:45.
- The time to enter sleep mode should not be set at the same time as or before the start time.
- If a backup job is scheduled during a disk check, disk format, backup job or within 5 minutes of the current time, the TeraStation will not change to standby mode when the configured time is reached.
- If scheduled times in the timer overlap, operation is performed using the widest time interval.
- Examples of multiple timer settings are shown below.

Example 1:

If running at a current time of 10:00 Wednesday

Timer 1: Daily 12:00–24:00

Timer 2: Not used

Timer 3: Not used

No operation is performed at 12:00 and the unit goes into sleep mode at 24:00.

Example 2:

If running at a current time of 10:00 Wednesday

Timer 1: Daily 9:00–18:00

Timer 2: Wednesday 10:00–20:00

Timer 3: Not used

On days other than Wednesday, normal operation begins at 9:00 and the unit goes into sleep mode at 18:00.

On Wednesday, the unit goes into sleep mode at 20:00.

Example 3:

If running at the current time of 10:00 Wednesday

Timer 1: Daily 9:00–18:00

Timer 2: Wednesday 10:00–1 am of the next day

Timer 3: Not used

On days other than Wednesday, normal operation begins at 9:00 and the unit goes into sleep mode at 18:00. On Wednesday, normal operation begins at 10:00 and the unit goes into sleep mode at 1:00 am of the next day.

Example 4:

When running at a current time of 10:00 Wednesday

Timer 1: Daily 9:00–18:00

Timer 2: Wednesday 7:30–22:00

Timer 3: Not used

On days other than Wednesday, normal operation begins at 9:00 and the unit goes into sleep mode at 18:00.

On Wednesday, normal operation begins at 7:30 and the unit goes into sleep mode at 22:00.

- To wake the TeraStation from sleep mode manually, press the power button.

Wake-on-LAN

The TeraStation supports Wake-on-LAN, which allows it to be turned on remotely.

- 1 In Settings, click *Network*.

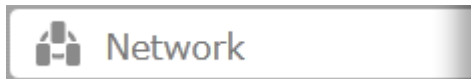

- 2 Click  to the right of "IP Address".



- 3 Click the LAN port that will receive Wake-on-LAN packets.

- 4 Enable "Wake-on-LAN", then click OK.

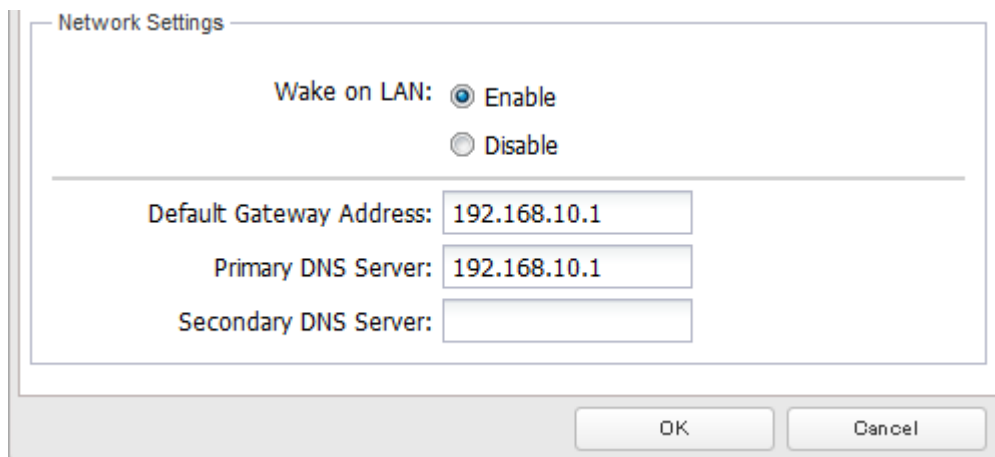

Wake-on-LAN is now enabled. As long as it is connected to power and the network, you can turn on the TeraStation remotely.

Notes:

- After a power outage, wait 5 minutes after power is restored to send the Wake-on-LAN packet to the TeraStation.
- After receiving the Wake-on-LAN packet, the TeraStation may take approximately five minutes to be ready to use.
- To use Wake-on-LAN, you'll need Wake-on-LAN software such as AMD's Magic Packet utility. The TeraStation does not include Wake-on-LAN software.
- The TeraStation does not support using Wake-on-LAN and port trunking at the same time. You may use either feature, but not both at the same time.

- On the local network, Wake-on-LAN packets may be sent to port 2304 on either of the TeraStation's LAN ports. If the TeraStation is connected to a Buffalo wireless router configured for remote access, then it may be turned on from outside the local network (from the WAN side). To use this feature, connect the router to only LAN port 1 on the TeraStation.
- If you send a Wake-on-LAN packet to the current main TeraStation (originally the backup TeraStation) right after it replaces the faulty TeraStation via failover, Wake-on-LAN may not work. In such a case, restart the TeraStation once.

UPS (Uninterruptible Power Supply)

If a UPS (sold separately) is attached, the TeraStation can be automatically shut down for protecting data in the event of a power outage.

- 1** Plug the power cable of the UPS to a wall socket.
- 2** Connect the AC cable of the TeraStation to the UPS.
- 3** Connect the UPS and TeraStation using a USB cable or serial cable.
- 4** Turn on the UPS, then the TeraStation.
- 5** In Settings, click *Management*.

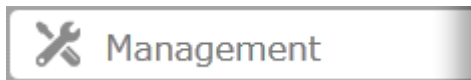

- 6** Click  to the right of "UPS Sync".



- 7** Click *Edit*.

8 Configure the desired settings, then OK.

Notes:

- If the TeraStation is connected directly to a UPS, select "Sync with UPS connected to this TeraStation". If a different TeraStation is connected to the UPS, select "Sync with UPS connected to another LinkStation or TeraStation on the same network". After making this selection, enter the IP address of the TeraStation that will be the sync source in "Other LinkStation or TeraStation's IP Address".
- When the TeraStation is rebooted after an automatic shutdown (such as from a power outage or power supply problem), verify that the power supply has been restored. If the TeraStation is turned on while it is still running on the UPS and without the power supply restored, automatic shutdown is not performed, even after the specified time has elapsed.
- If the power supply from the UPS to the TeraStation is stopped and restarted when UPS recovery is enabled, the TeraStation is automatically restarted.

Port Trunking

Two Ethernet cables can be used to establish two separate communication routes providing LAN port redundancy and improving communication reliability. The use of two Ethernet cables enables access to the TeraStation even if one of the cables is disconnected.

The port trunking modes that can be set in the TeraStation are shown below.

Trunking Mode	Characteristics
Round-robin*	Network packets are transmitted in sequential order from the first available NIC slave through the last.
Active-backup	Only one NIC slave in the bond is active. A different slave becomes active if and only if the active slave fails.
XOR*	Transmits network packets based on [(source MAC address XOR'd with destination MAC address) modulo NIC slave count]. This selects the same NIC slave for each destination MAC address.
Broadcast	Transmits network packets on all slave network interfaces.
Dynamic link aggregation**	Creates aggregation groups that share the network speed and duplex settings. Utilizes all slave network interfaces in the active aggregator group according to the 802.3ad specification.

Trunking Mode	Characteristics
TLB	The outgoing network packet traffic is distributed according to the current load (relative to the speed) on each network interface slave.

*A separate intelligent switch that supports EtherChannel or other port trunking is required. Configure two LAN ports on the switch for port trunking first.

**A separate intelligent switch that supports IEEE 802.3ad is required. Configure LACP in the switch first.

Configuring Port Trunking

If the TeraStation is being used as an iSCSI hard drive, disable iSCSI before changing network settings such as port trunking. Navigate to *Drives - iSCSI* in Settings and move the iSCSI switch to the  position temporarily.

1 Use an Ethernet cable to connect the hub LAN port and TeraStation LAN port 1.

Notes:

- Do not connect the second Ethernet cable to the TeraStation yet.
- If using an intelligent switch, configure the LAN ports on the switch first, before connecting to the TeraStation.

2 In Settings, click *Network*.

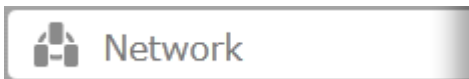

3 Click  to the right of "Port Trunking".



4 Choose a port trunking link.

5 Select the LAN port that will be used, select the port trunking mode, and click *Accept*.

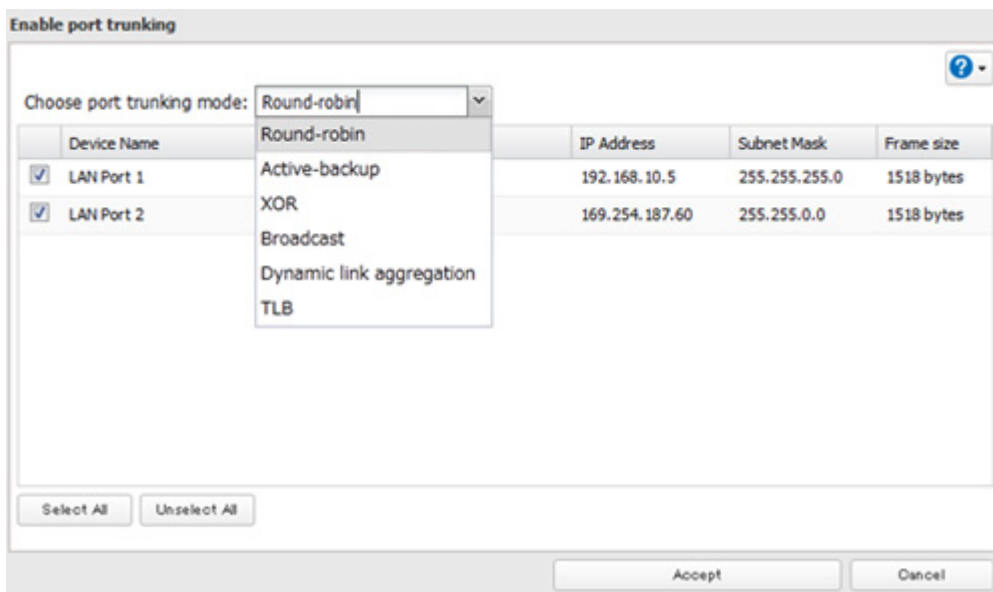

6 Connect the hub's LAN port and TeraStation's LAN port using the second LAN cable. If you are using an intelligent switch, connect to the LAN port that was previously configured for port trunking.

7 Reboot the TeraStation before use.

Connecting a Printer

You can connect a printer to the USB port on the TeraStation.

Notes:

- Only one USB printer can be connected to the TeraStation.
- Bidirectional communication is not supported i.e., remaining ink quantities and other printer status information is not displayed.
- If a multifunctional printer is connected, only the printer function can be used. Other functions such as scanning will not be available.
- The print server does not support Mac OS.
- Don't disable the SMB protocol while the print server is enabled. If you do, you will need to enable SMB again and reconfigure the print server from scratch.

Setting Up a Printer with Windows 8.1, Windows 8, Windows 7, or Windows Vista

1 In Settings, click *Services*.



2 Move the print server switch to the  position to enable the print server.

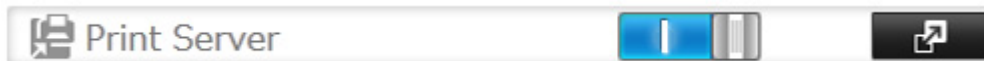

3 Refer to the manual supplied with the printer and install the printer drivers.

4 Click *Start - Network*. For Windows 8.1 and Windows 8, click the *Network* in *File Explorer*.

5 Double-click the TeraStation server name.

6 Double-click the icon of the connected printer (shared name is displayed).

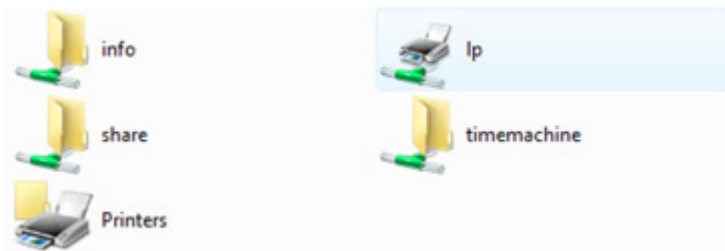

- 7 Select your printer, then click OK.



- 8 Register the printer.

Setting Up a Printer with Windows XP

- 1 In Settings, click *Services*.



- 2 Move the print server switch to the  position to enable the print server.



- 3 Refer to the manual supplied with the printer.
- 4 Click *Start - Control Panel*.
- 5 Click *Network and Internet Connections*.
- 6 Click *My Network Places- View workgroup computers - (Name of the TeraStation Server)*.
- 7 Double-click your printer icon.

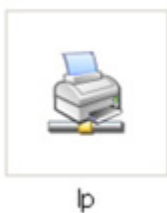

- 8 When "The server for the printer does not have the correct printer driver installed. If you want to search for the proper driver, click OK." displays, click OK.

9 Register the printer.

TeraSearch

TeraSearch lets you search for character strings contained in files (text files, Word files, etc.) stored on the TeraStation. Follow the steps below to enable it.

- 1** In Settings, click *File Sharing*.

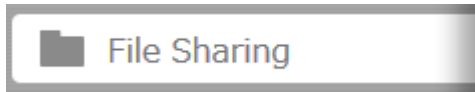

- 2** Click  to the right of "Folder Setup".

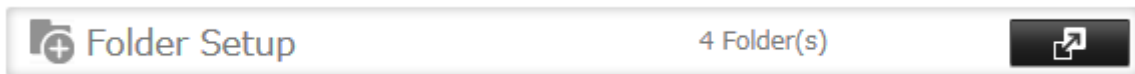

- 3** Click the shared folder to be indexed.

- 4** Click *Edit*.

- 5** Check "Include this folder in the search index", then click *OK*.

- 6** Click *OK*.

- 7** Click *Close*.

- 8** Click *Applications*.

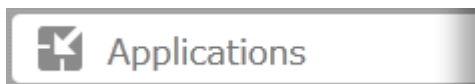

- 9** Move the TeraSearch switch to the  position to enable TeraSearch.



- 10** Click  to the right of "TeraSearch".

11 Click *Refresh Index*

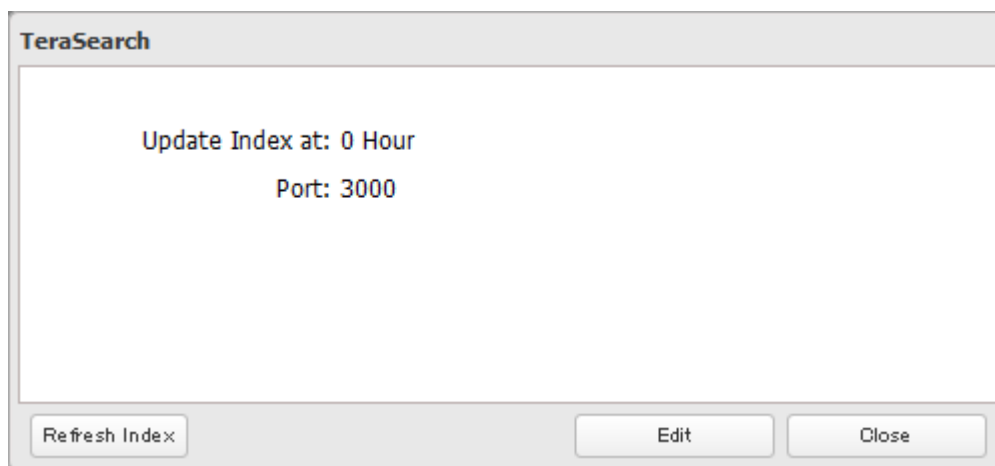

12 Click *Edit*.

13 Enter the port number that you want to use and the time that the index will be updated, then click *OK*.

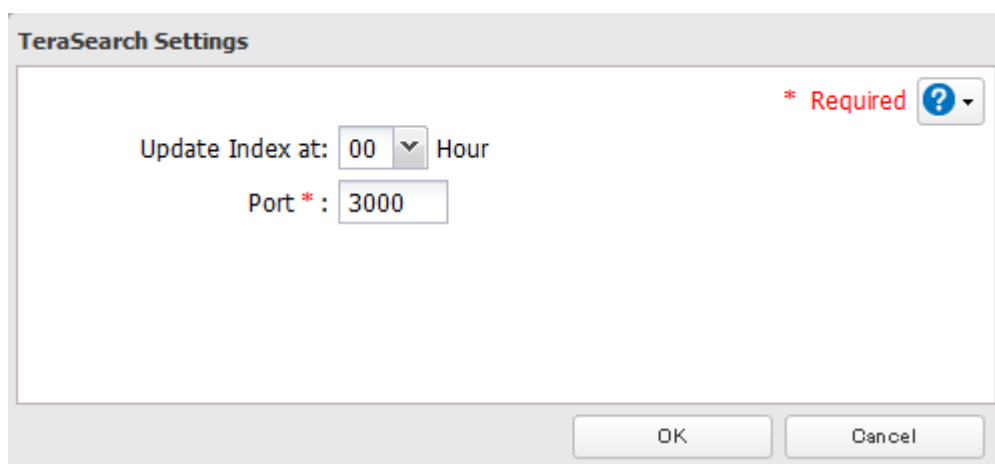

14 Open the following URL in your browser.

[http://\(IP address of your TeraStation\):3000/](http://(IP address of your TeraStation):3000/)

Note: You can identify your IP address from NAS Navigator2.

15 Enter your TeraStation's username and password, then click *Login*.

16 Enter a keyword in the "Search Text" field. Check "Advanced Search" to enable searches by specifying the filename, owner, date updated, and file size.

17 Click *Search*. The search results are displayed. Click the filename in the results to open the file.

Offline Files

The "offline files" feature that is included with many versions of Windows can be used with files on the TeraStation. You will be able to work on files stored on the TeraStation even when your PC is disconnected from the network. When you next connect to the network, the updated files are written and synchronized. Follow the procedure below to configure offline files.

1 In Settings, click *File Sharing*.

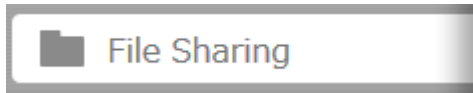

2 Click  to the right of "Folder Setup".



3 Click the shared folder for offline files.

4 Click *Edit*.

5 Choose "Manual File Caching", "Automatic File Caching", or "Automatic Program and File Caching", then click *OK*.

Note:

- "Manual File Caching" - User selects files that are cached.
- "Automatic File Caching" - Opened files can be cached locally for offline use. Previous versions of files that are not synchronized are automatically replaced by the latest versions.
- "Automatic Program and File Caching" - Opened files can be cached locally for usage offline. Previous versions of files and applications executed from the network that are not synchronized are automatically replaced by the latest version of the files and applications.

6 Click *OK*.

7 Click *Close*.

8 In Windows, navigate to *Folder options*. (Windows 8.1, Windows 8, and Windows 7 users should skip to step 9).

- 9 Check "Enable Offline Files", then click OK.

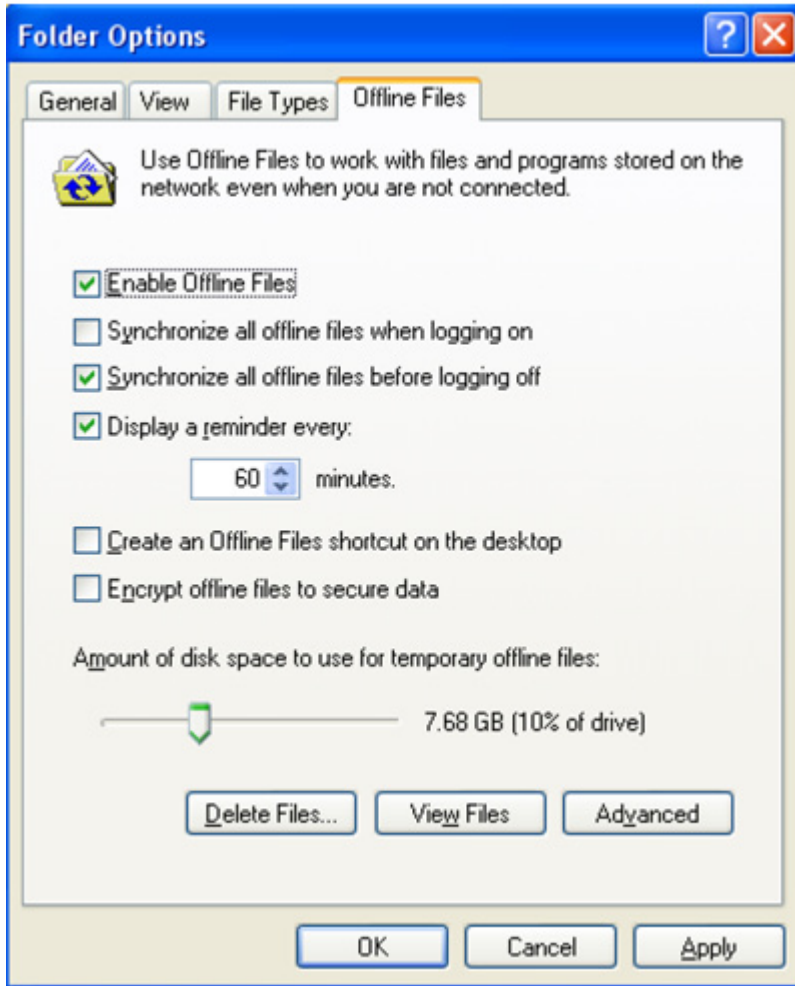

Note: Offline files cannot be enabled if "Use Fast User Switching" is enabled. To change the setting, open "User Accounts" in Control Panel and select "Change the way users log on or off".

- 10 Right-click the icon of the shared folder on the TeraStation for which you have set the offline feature, then click *Always available offline*. If the offline file wizard opens, follow the instructions on the screen.

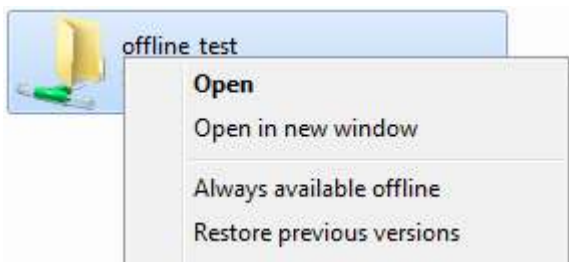

- 11 When the offline settings and sync settings are completed, the files and folders set appear as shown:



- 12 If the computer is disconnected from the network after synchronization is completed, the offline file function can be used.

Offline files can be accessed by the original Universal Naming Convention (UNC) where the data was saved.

Note: If you cannot access offline files, try the following procedure:

- (1) Reconnect the computer to the network.

- (2) Navigate to *Start - All Programs - Accessories - Sync Center* and click *Sync All* to synchronize all offline files.
- (3) Disconnect the computer from the network and verify that you can access offline files.

DFS

DFS (Distributed File System) is a set of client and server services that allows Windows users to organize many distributed SMB file shares into a distributed file system. Follow the steps below to enable DFS on the TeraStation.

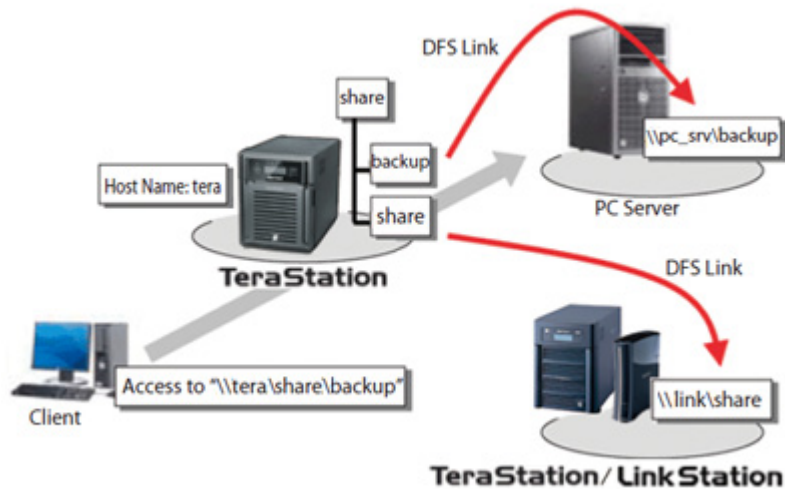

- 1** In Settings, click *File Sharing*.

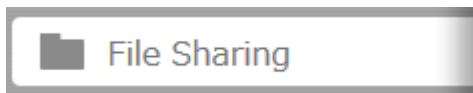

- 2** Click  to the right of "DFS".

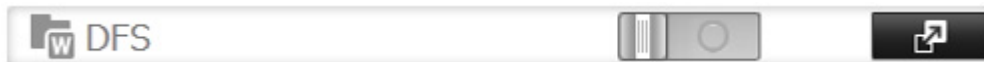

- 3** Click *Edit*.

- 4** Enable or disable "Set DFS Link to DFS Root".

If enabled, a DFS link target shared folder is created under the DFS root. If disabled, up to 8 DFS link target shared folders can be created under the DFS root.

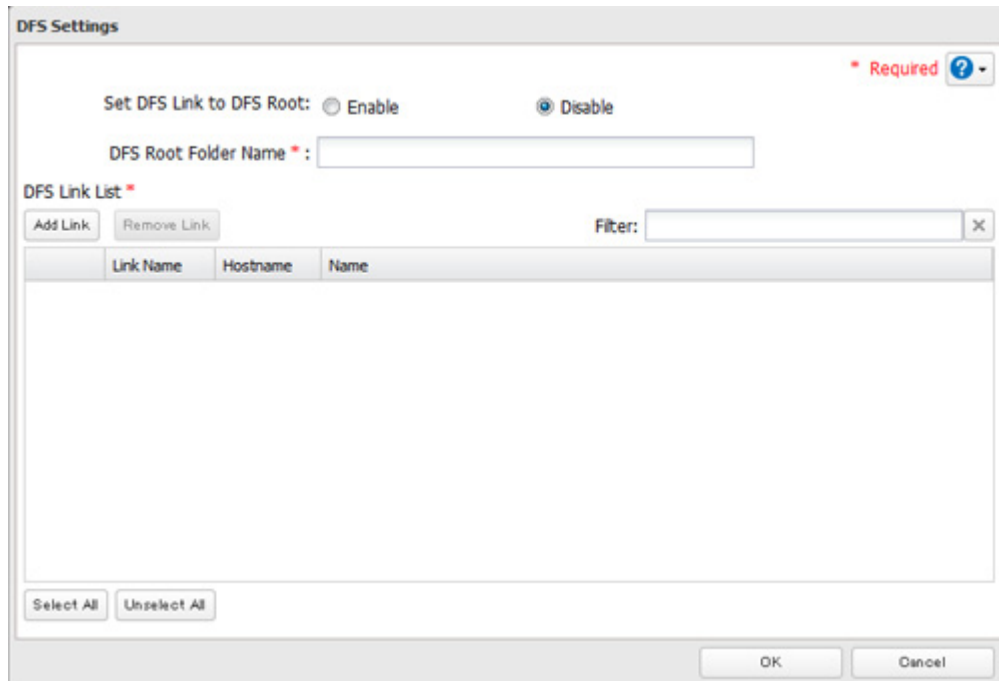

- 5 Enter *DFS Root Folder Name*.
- 6 Click *Add Link*.
- 7 Enter the link name, hostname, and shared folder name, then click *OK*.

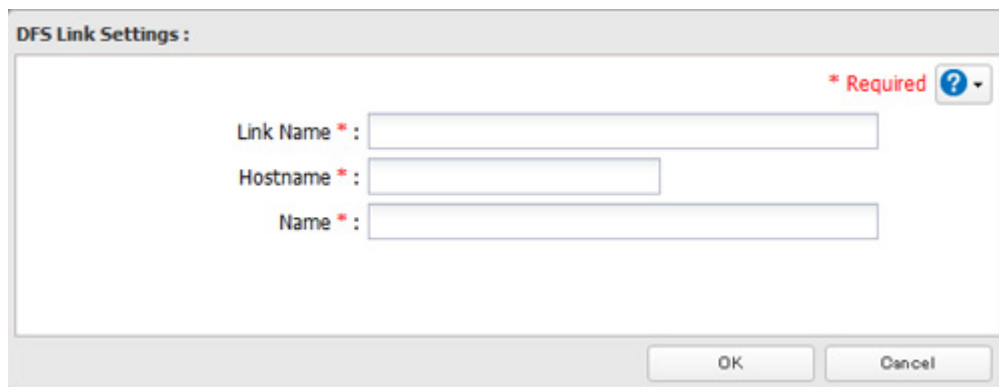

- 8 Click *OK*.
- 9 Move the DFS switch to the  position to enable DFS.



Notes:

- Don't disable the SMB protocol while DFS is enabled. If you do, you will need to enable SMB again and reconfigure DFS from scratch.
- TeraStations, LinkStations, and SMB-compatible Windows computers can be specified as DFS link targets (Mac OS and Linux are not supported).

Accessing from an NFS Client

Note: (US purchasers only) Buffalo's customer support will help configure the NFS settings on your TeraStation, and will support VMware and Windows clients but will not provide support for configuring your Linux or other UNIX clients. There are many types of UNIX and the procedures for configuring NFS with them will vary considerably. For help configuring your NetWare, Linux, or other UNIX clients for NFS support please consult each client's own documentation and support.

- 1 In Settings, click *File Sharing*.

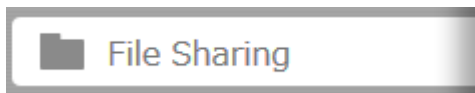

- 2 Click  to the right of "Folder Setup".



- 3 Choose the shared folder that will be accessible to the NFS client.

- 4 Click *Edit*.

- 5 Under "LAN Protocol Support", check "NFS" and click *OK*.
Note the NFS path. It will be used later for accessing data from an NFS client.

- 6 Click *Close*.

- 7 Move the NFS switch to the  position to enable NFS.



- 8 Click  to the right of "NFS".

- 9 Click *Client Settings*.

10 Click *Add Client*.

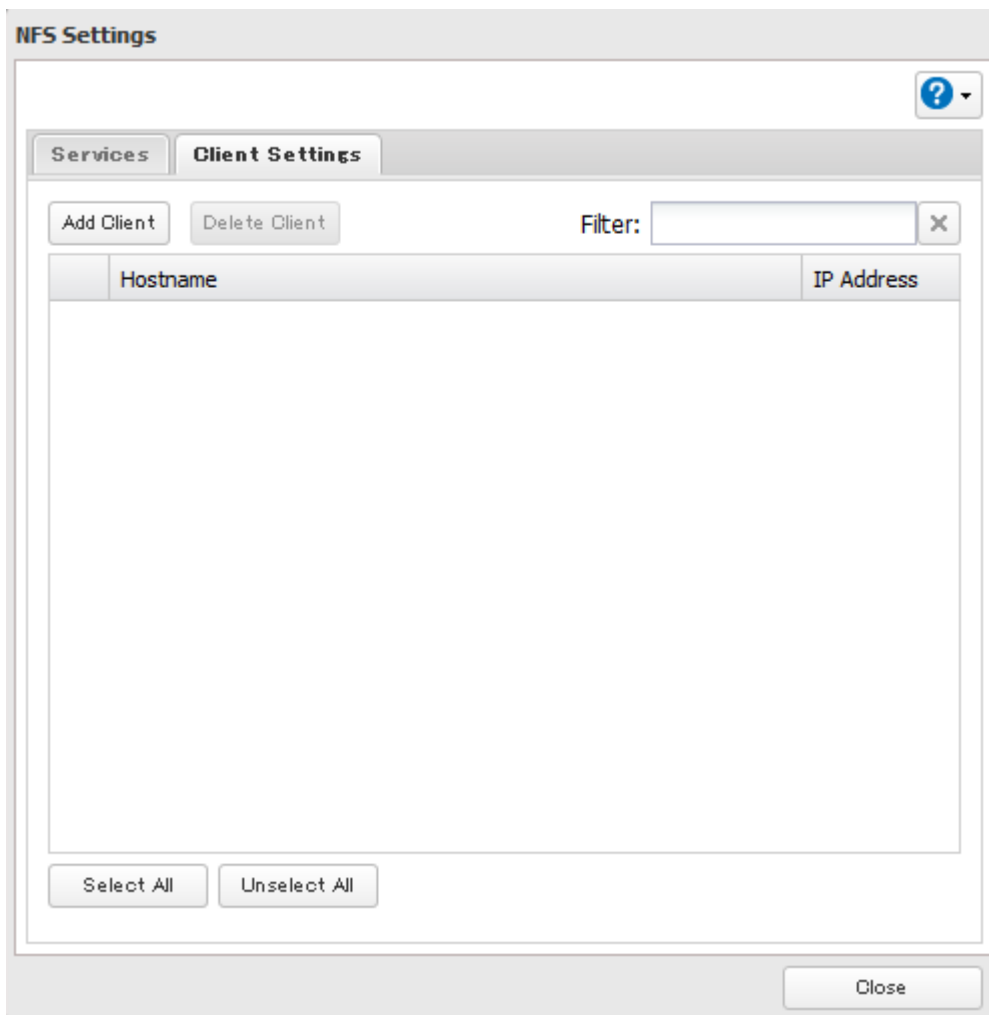

11 Enter the IP address and hostname of the NFS client, then click *OK*.

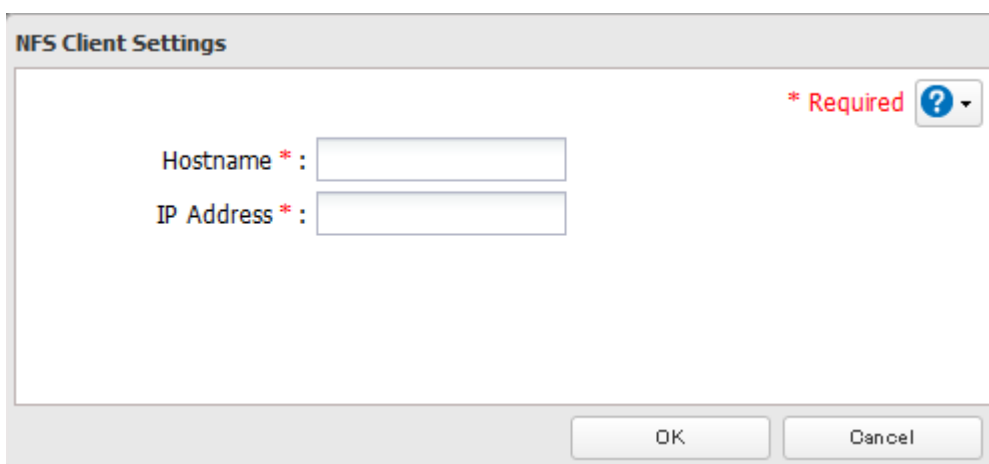

Note: To delete a client, check the hostname and click *Delete Client*.

12 Click *Close*.

13 Enter the mount command to access the shared folder from the NFS client.

The mount command depends on your operating system. The examples below assume that IP address of your TeraStation is 192.168.11.10, "/mnt/array1/share" is the desired NFS path, and "/mnt/nas" or drive letter "z" is the mount point.

For Linux:

```
mount -t nfs 192.168.11.10:/mnt/array1/share /mnt/nas
```

For Windows Service for Unix 3.5:

```
mount 192.168.11.10:/mnt/array1/share z:
```

For Solaris 10:

```
mount -F nfs 192.168.11.10:/mnt/array1/share /mnt/nas
```

Notes:

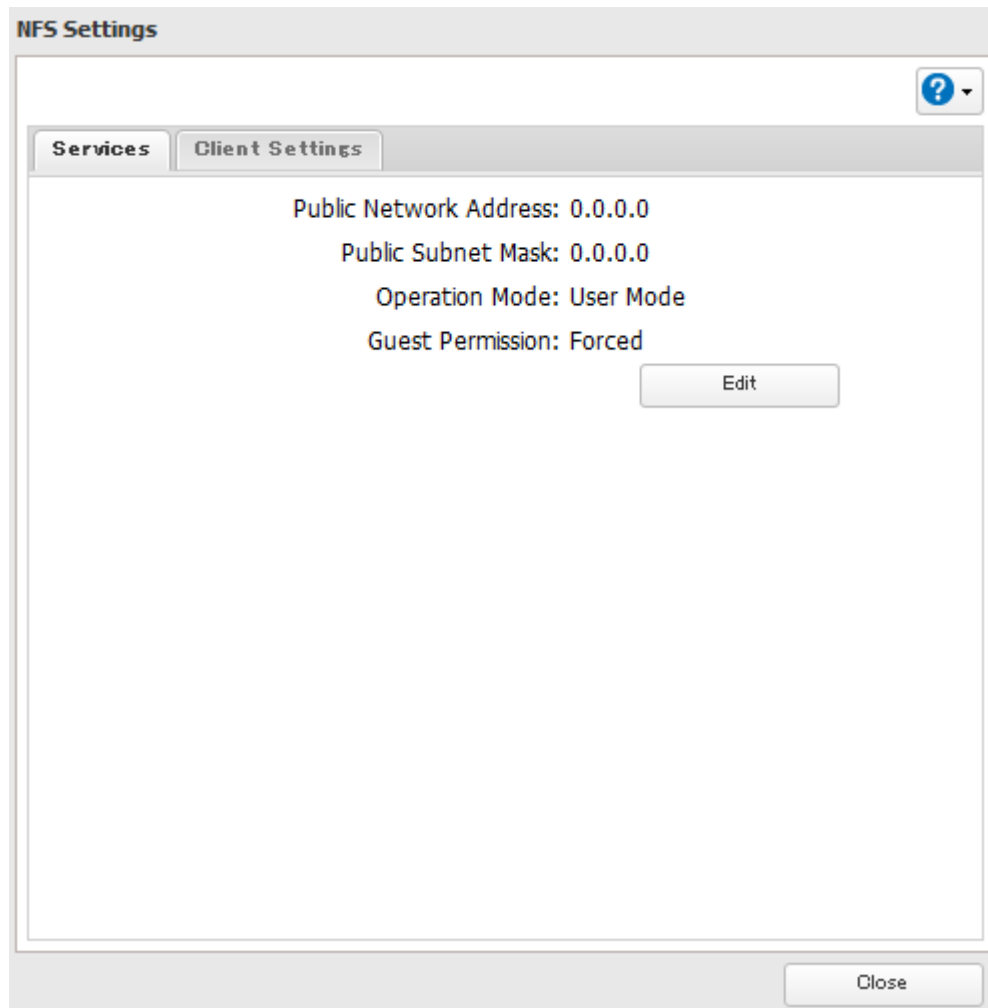

- To configure access restrictions by IP address, click *Services - Edit*, then enter the desired settings.
- To use shared folders set for NFS as drives on VMware ESX/ESXi, change the operation mode from "User Mode" (default setting) to "Kernel Mode" on the screen navigating to *Services - Edit*.
- If you configure "Guest Permission" to "Forced" on the screen navigating to *Services - Edit*, user ID and group ID should be 99 when the data is written from NFS clients; this is recommended for SMB or other protocols as well. Use "Ignored" if the TeraStation only enables NFS connection.

Encrypting Data Transmission

Encrypting Settings Data

All communication with Settings can use SSL encryption if you access settings through `https://`.

Encrypting FTP Transfer Data

You can encrypt passwords and files using SSL/TLS for secure FTP communication. First, open a shared folder's settings and click *Edit*; under "LAN Protocol Support", check "FTP" and click *OK*. Enable SSL security in the setup screen for your FTP client. The procedure depends on the FTP client software.

SSL Keys

SSL keys are used during setup screen operations and FTP communication. SSL (Secure Socket Layer) is a type of encryption system called public key encryption. Generally, SSL is managed by the two files below.

server.crt (SSL Certificates)

The TeraStation sends the file to a computer, and the computer uses it to perform encryption. The TeraStation receives the encrypted data and uses server.key (the private key) to decrypt the data.

In SSL, this key contains the server certificate, and depending on your computer environment, a check may be performed to determine the trustworthiness of the certificate. The server certificate included in the TeraStation in the default settings was created by Buffalo, and in some cases the message "There is a problem with this website's security certificate" may be displayed in your browser or other software. Disregard this message and continue.

server.key (SSL Key)

This file is used as a pair with server.crt (server certificate). This is required for decrypting the data that was encrypted by the server certificate, and this is normally not revealed.

Updating SSL Key

To update a server certificate and a private key for SSL, follow this procedure.

- 1 Navigate to *Management - SSL*.
- 2 Register "server.key" for "Secret Key" and "server.crt" for "Server Certificate (.crt)", then click *Import*.

Notes:

- Place the SSL key files (server.key, server.crt) directly below the C root drive. The SSL key may not be able to be updated if it is placed in folders or paths that contain multi-byte characters.
- Use the provided password for the SSL key.
- If Settings cannot be displayed after updating, initialize the TeraStation settings.
- Updating the firmware initializes an SSL key.

Web Server

The TeraStation can be used as a web server. In addition to HTML files, images, and JavaScript, the TeraStation also allows installation of Perl script and PHP script files.

- 1 In Settings, click *Services*.



- 2 Move the web server switch to the  position to enable the web server.



- 3 Click  to the right of "Web Server".

4 Click *Edit*.

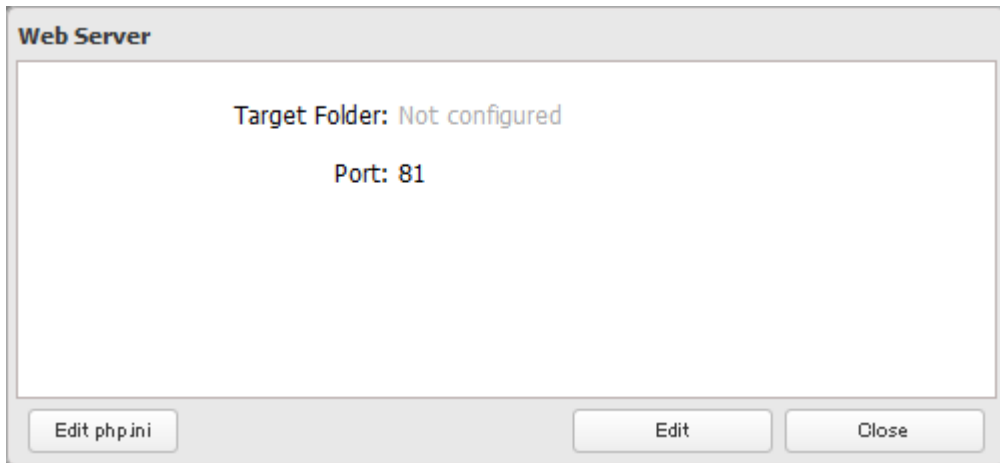

Note: The settings of the PHP language interpreter can be changed from "Edit php.ini".

5 Click *Browse*.

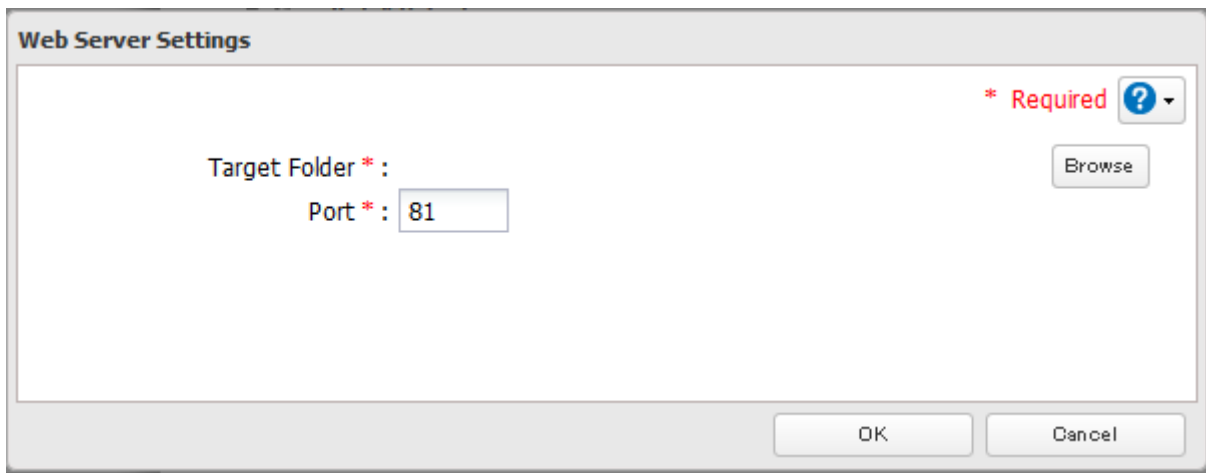

- 6 Choose a shared folder for the web server , then click *OK*.

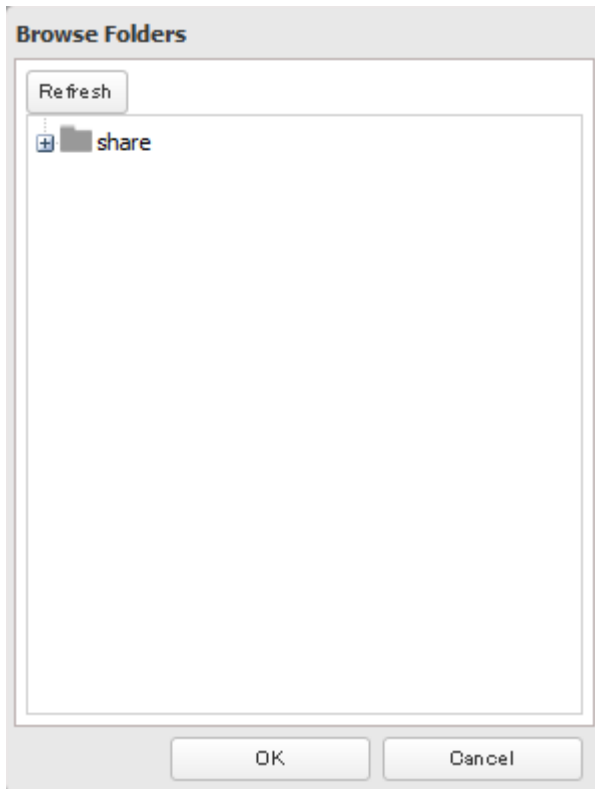

- 7 Choose an external port, then click *OK*.

MySQL Server

The TeraStation can be used as a MySQL server. A MySQL database may be installed and linked with the web server.

- 1 In Settings, click *Services*



- 2 Move the MySQL server switch to the  position to enable the MySQL server.

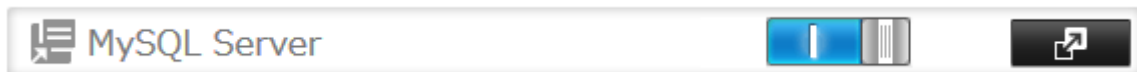

- 3 Click  to the right of "MySQL Server".

- 4 Click *Edit*.

5 Click *Browse*.

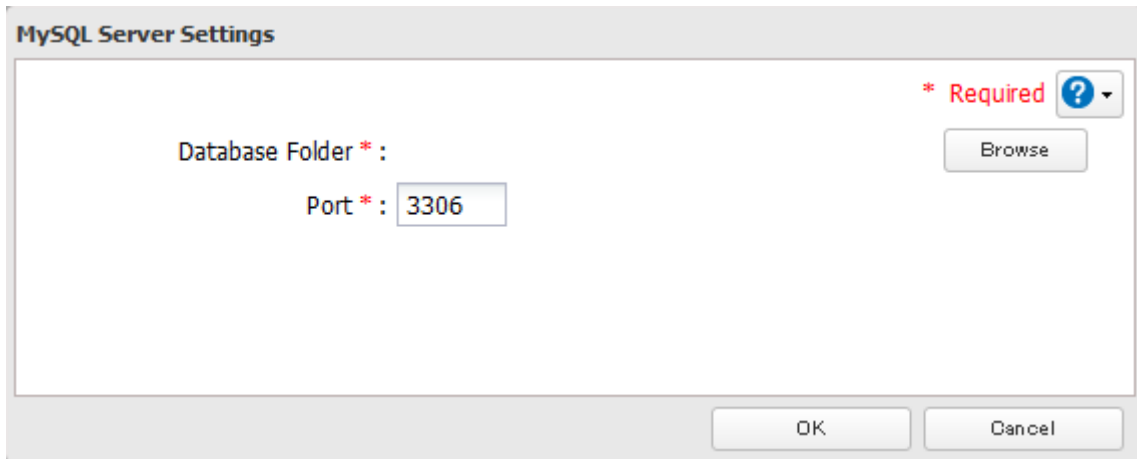

6 Choose a shared folder for the MySQL server, then click *OK*.

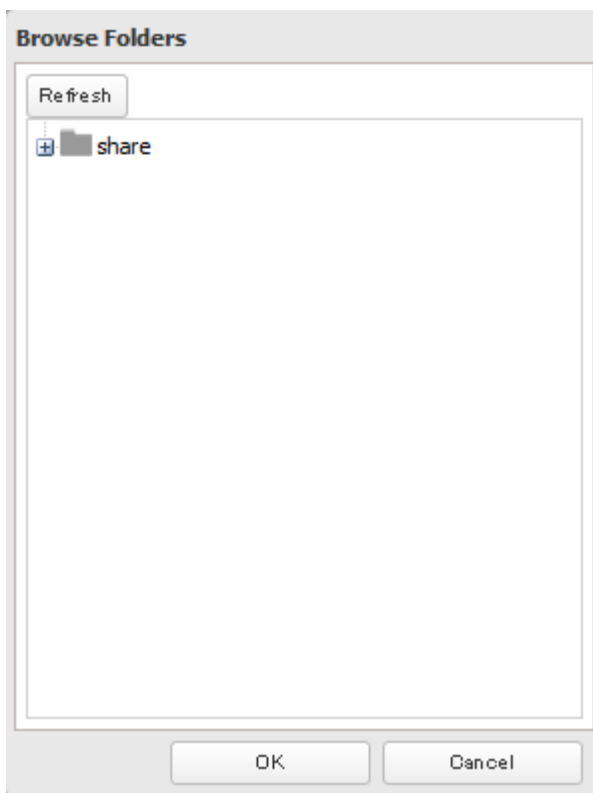

7 Choose an external port, then click *OK*.

SNMP

If SNMP is enabled, you can browse your TeraStation from SNMP-compatible network management software. The specific MIB (management information base) file for Buffalo is available from the Buffalo website.

1 In Settings, click *Network*.

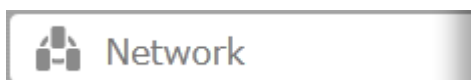

2 Move the SNMP switch to the  position to enable SNMP.

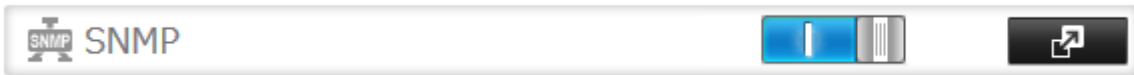

3 Click  to the right of "SNMP".

4 Click *Edit*.

5 Configure the desired settings, then click *OK*.

Saving and Applying Settings

The TeraStation's settings can be saved to a USB memory device and restored to another TeraStation of the same series. Use this function to back up and copy settings to a new TeraStation.



Make a note of the hard drive configuration (number of hard drives, RAID, LVM, etc.) of the TeraStation where the settings were saved. Make sure that any TeraStation that you apply these settings to has exactly the same hard drive configuration before you apply the settings. If the drive configuration is different, you may get unexpected results.

The following settings are not saved or restored:

Category	Settings
File Sharing	Shared folder information of USB drive and media cartridge
Drives	All settings in "Drives"
	All settings in "RAID" - "Options" - "RAID Array Settings"
	All settings in "LVM"
	All settings in "iSCSI"
Network	USB drive and media cartridge information
	All settings in "IP Address", except for service port restrictions, Wake-on-LAN, and Ethernet frame size settings
Backup	All settings in "Port Trunking"
	All settings in "Failover"
Management	All settings in "Name", except for descriptions
	All settings in "UPS Sync"
	All settings in "SSL"
	Display language in Settings

Saving Settings

1 Insert a USB memory device into a USB port on the TeraStation.

Notes:

- Use a USB 2.0 port. If your TeraStation has both USB 3.0 and USB 2.0 ports, make sure that you use one of the USB 2.0 ports.

- The USB memory device should have a capacity of at least 1 GB.
- Any data stored on the USB memory device will be deleted.

2 In Settings, click *Management*.

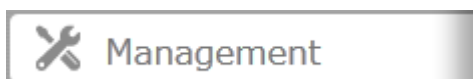

3 Click  to the right of "Restore/Erase".

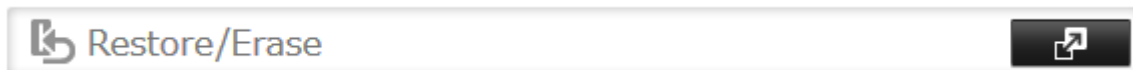

4 From "Target USB drive", select the USB memory device that is connected to the USB 2.0 port of the TeraStation.

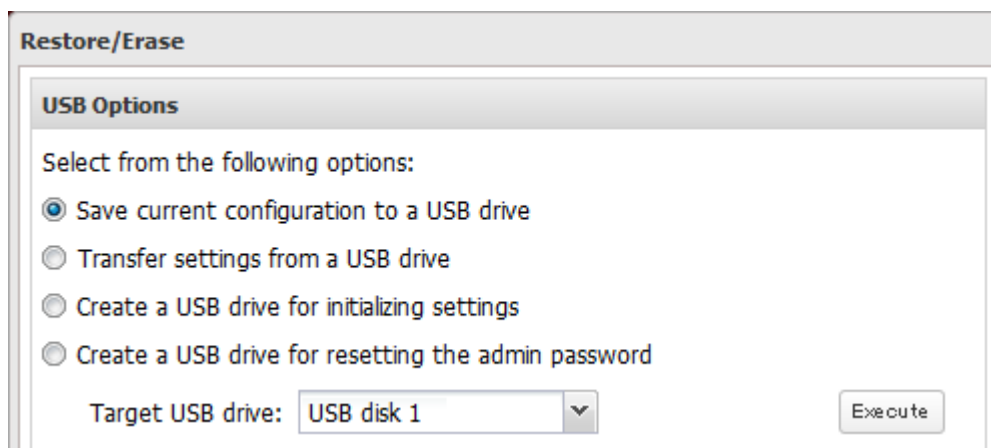

5 Select "Save current configuration to a USB drive", then click *Execute*.

Troubleshooting:

If the settings are not saved to the USB memory device successfully, you may receive the error message "The specified operation cannot be executed.". Verify:

- The device is connected to a USB 2.0 port, not a USB 3.0 port.
- The device has a capacity of 1 GB or larger.
- The device is not write-protected.

Applying Settings

The saved settings can be applied to a different TeraStation (of the same series).

1 Connect the USB memory device with the saved settings to a USB 2.0 port of the TeraStation (not a USB 3.0 port).

2 In Settings, click *Management*.

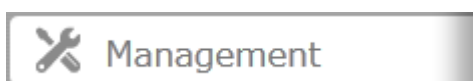

- 3 Click  to the right of "Restore/Erase".



- 4 From "Target USB drive", select the USB memory device that is connected to the USB 2.0 port of the TeraStation.

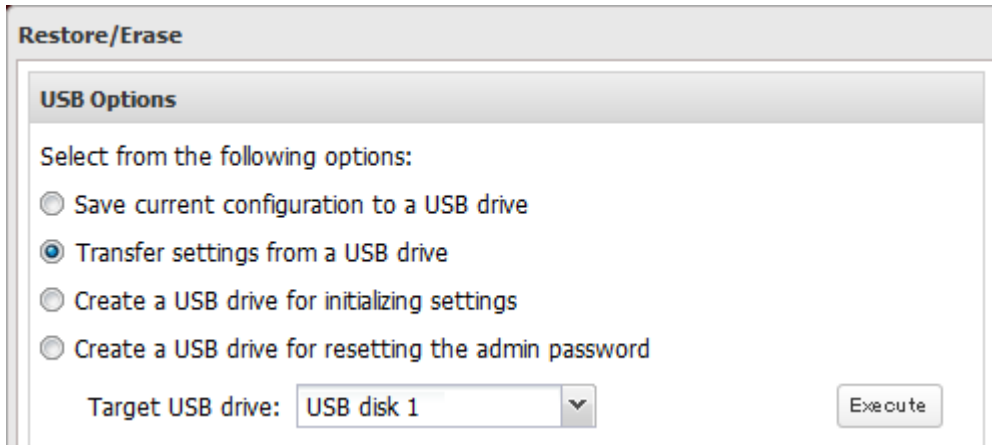

- 5 Select "Transfer settings from a USB drive", then click *Execute*.

Restoring Factory Defaults

Initializing from Settings

To initialize the TeraStation to its factory defaults from Settings, follow this procedure.

- 1 In Settings, click *Management*.

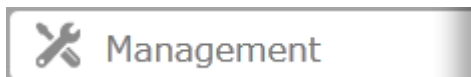

- 2 Click  to the right of "Restore/Erase".

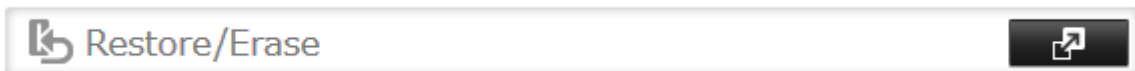

- 3 Click *Initialize TeraStation*.

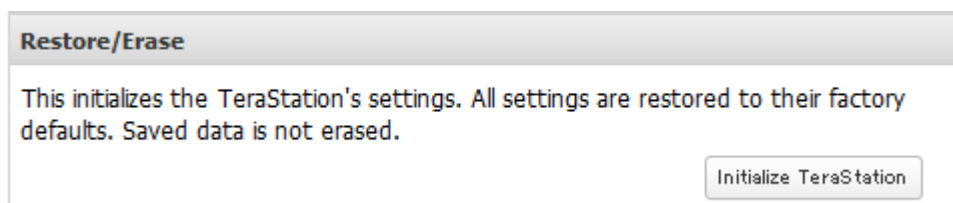

- 4 The "Confirm Operation" screen will open. Enter the confirmation number, then click *OK*.

- 5 The TeraStation will be restored to its factory default settings.

Creating an Initialization Drive

A system initialization drive will restore the settings on your TeraStation to their factory defaults. You can initialize them without logging in to Settings. Follow the steps below to create a system initialization drive.

Notes:

- Normally, making and using the system initialization drive will not affect data. However, always back up your data regularly!
- This USB drive can be used to recover the system if your TeraStation doesn't boot at all. In this case, if the data partition is damaged, then all your data will be deleted by the recovery process.

- 1** Insert a 1 GB or larger USB flash drive (not included) into a USB 2.0 port on the TeraStation.
- 2** In Settings, navigate to *Management - Restore/Erase - USB Options*.
- 3** Select *Create a USB drive for initializing settings*.
Note: All data on the USB flash drive will be erased!
- 4** Select the USB memory device from "Target USB drive", then click *Execute*.
- 5** Enter the 4 digit confirmation number and click *OK*. The TeraStation will create the initialization drive. This will take about a minute.
- 6** When the "finished" dialog opens, the USB initialization drive is ready to use. Dismount the USB drive before unplugging it. See "Dismounting Drives" in chapter 4 for the instructions on dismounting drives.

Initializing with the USB Drive

To initialize the settings on your TeraStation with the USB drive as created above, follow the procedure below.

Note: If using the initialization drive to initialize, the unit's current firmware version will be changed to the version used to create the initialization drive.

- 1** Create a USB "initialization drive" as described above.
- 2** Insert the USB drive into a USB 2.0 port (not a USB 3.0 port) on the TeraStation. Make sure that no other USB drives are connected to any USB ports on the TeraStation.
- 3** Set the boot mode switch to "USB".
- 4** Press the power button to turn on the TeraStation.
- 5** When the I41 message appears on the LCD panel, press the function button.
- 6** It will take several minutes for initializing the settings. The TeraStation will shut down when it's finished.
- 7** After shutdown, the I39 message is displayed.
- 8** Set the boot mode switch to "HDD" position.
- 9** Press the power button to start the TeraStation.

Resetting the Administrator Password

Creating a Password Reset Drive

A password initialization drive can reset the administrator password to its default value ("password"). This could be very useful if you forget your admin password.

- 1** Connect a 1 GB or larger USB memory device (not included) to a USB 2.0 port on the TeraStation.
- 2** In Settings, navigate to *Management - Restore/Eraser - USB Options*.
- 3** Select *Create a USB drive for resetting the admin password*.
Note: All data on the USB flash drive will be erased!
- 4** Select the USB memory device from "Target USB drive" list, then click *Execute*.
- 5** Enter the 4 digit confirmation number and click *OK*. The TeraStation will create the password reset drive. This will take about a minute.
- 6** When the "finished" dialog opens, the password reset drive is ready to use. Dismount the USB drive before unplugging it. See "Dismounting Drives" in chapter 4 for the instructions on dismounting drives.

Resetting with the USB Drive

To reset your admin password, follow the procedure below.

- 1** Create a USB "password initialization" drive as described above.
- 2** Insert the USB drive into a USB 2.0 port (not a USB 3.0 port) on the TeraStation.
- 3** Set the boot mode switch to "USB".
- 4** Press the power button to turn on the TeraStation.
- 5** When the I41 message appears on the LCD panel, press the function button.
- 6** The password will be reset to its factory default. The TeraStation will shut down when it's finished.
- 7** After shutdown, the I39 message is displayed.
- 8** Set the boot mode switch to "HDD" position.
- 9** Press the power button to start the TeraStation.

Logs

Follow the procedure to check the TeraStation's logs.

- 1** In Settings, click *Management*.

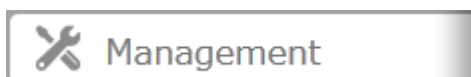

- 2 Click  to the right of "Logs".

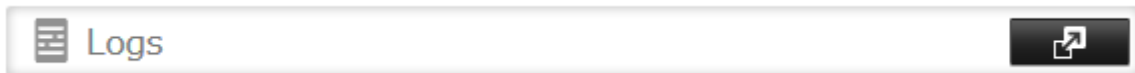

- 3 Click *Edit*.

- 4 Select a log to view.

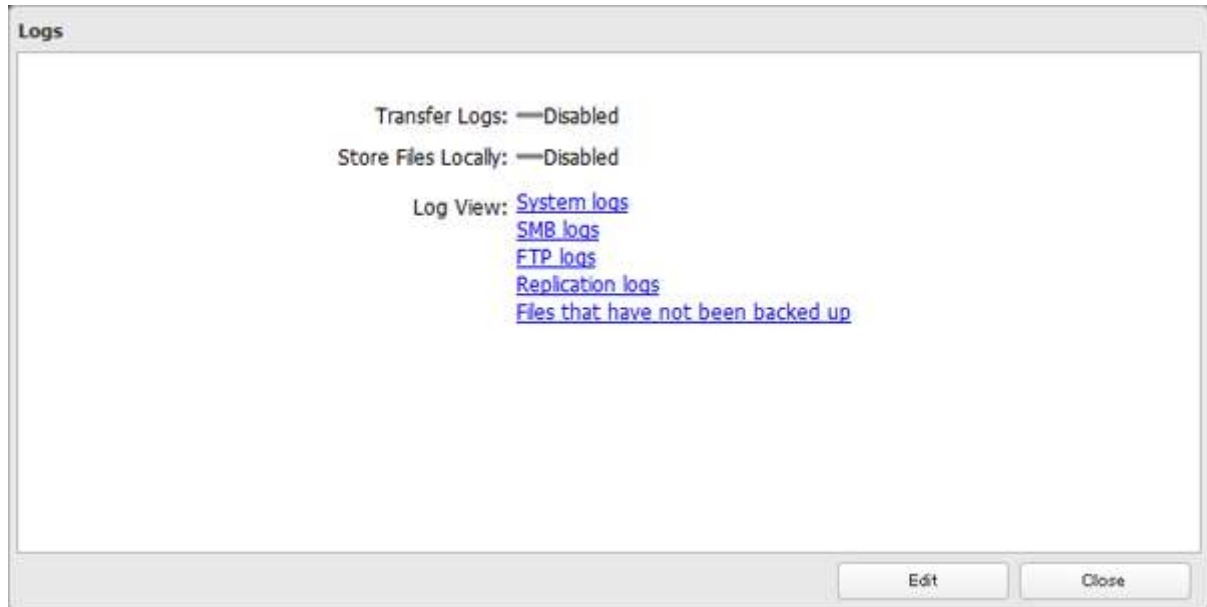

The file operation log stores file operations performed on the internal hard drives. File operations on USB drives are not logged.

Note: All logs are encoded in UTF-8 format. To show them correctly, change the software encoding to "UTF-8".

To transfer logs

- 1 Click *Edit*.
- 2 Enable "Syslog Transfer".
- 3 Enter the IP address of the syslog server where you want to transfer the logs to.
- 4 Select the type of log that you want to transfer from "Logs to Transfer".
- 5 Click *OK*.

Note: FTP logs cannot be written to a syslog server.

To create a link to the logs in the shared folder

- 1 Click *Edit*.
- 2 Enable "Share Link to Logs".
- 3 Select the shared folder where the link will be created in "Target Shared Folder".
- 4 Click *OK*.

Under the selected shared folder, a folder named "system_log" will now contain the logs.

Updating the Firmware

If a new firmware is available, a message is displayed when the TeraStation boots. You can update the firmware by following ways:

Notes:

- Updating version 2.40 or earlier firmware to 2.60 will overwrite your current guest account and user accounts email address settings. The guest account will be enabled and all user accounts' email addresses will be blank. Reconfigure your desired guest and user account settings after this update.
- If all drives and RAID arrays on the TeraStation have LVM enabled but no LVM volumes have been created, you will not able to update the firmware from Settings.
- Settings is not available while the firmware is updating. Don't try to access Settings from another computer until the update is complete.

Updating Manually

- 1** In Settings, click *Management*.

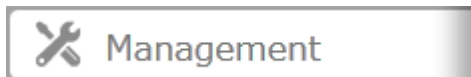

- 2** Click  to the right of "Update".



- 3** Click *Install Update*.

You can also download the latest firmware from the Buffalo website.

Updating Automatically

- 1** In Settings, click *Management*.

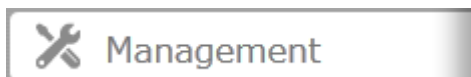

- 2** Click  to the right of "Update".



- 3 Click *Update Settings*.

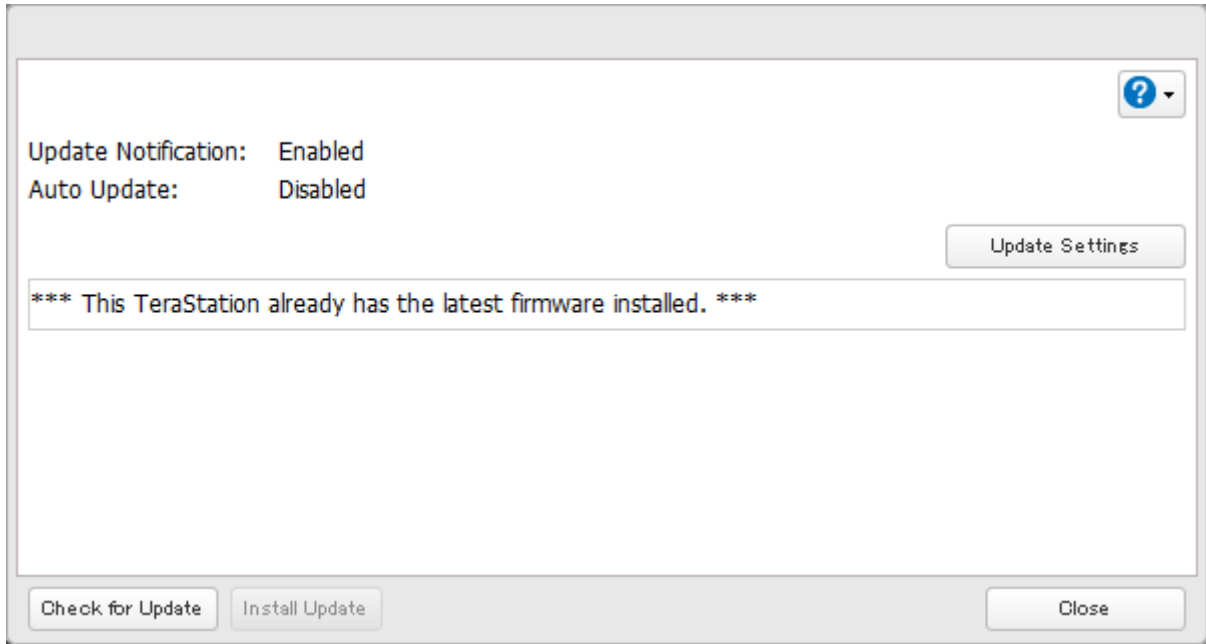

- 4 Select "Update the firmware automatically" and click *OK*.

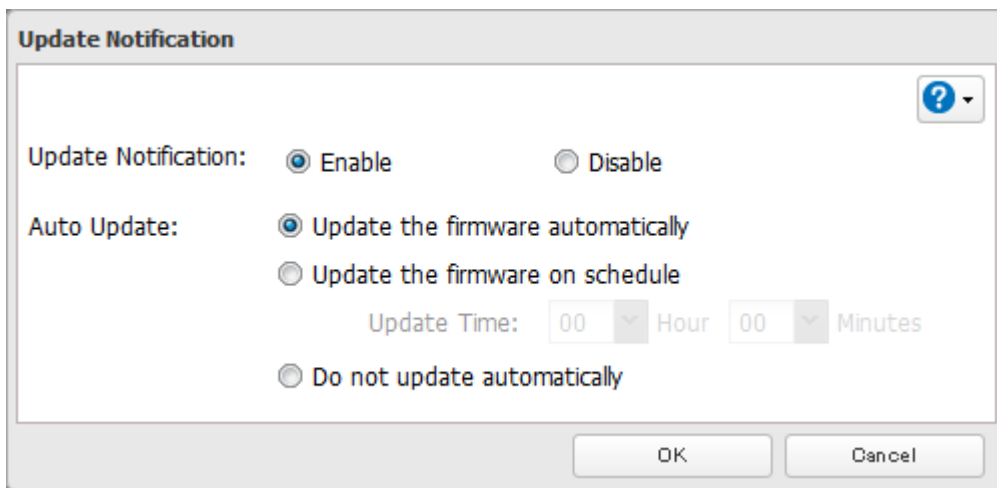

Alternately, you may choose to schedule updates for a specific time of day.

Name, Date, Time, and Language

Configure the TeraStation's hostname, date, time, and language as shown below.

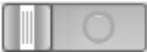
Note: If the TeraStation is being used as an iSCSI hard drive, to change the settings, navigate to *Drives - iSCSI* in Settings and set the icon to .

- 1 In Settings, click *Management*.

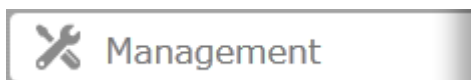

- 2 Click  to the right of "Name/Time/Language".

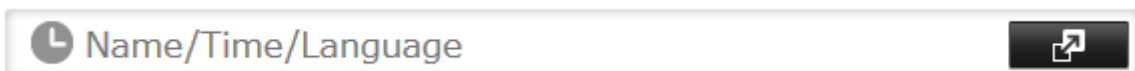

3 Click *Edit*.

4 Click the *Name* tab, then configure the TeraStation's name and description.

The screenshot shows a dialog box titled "Name/Time/Language". In the top right corner, there is a red asterisk followed by the word "Required" and a blue question mark icon. Below the title bar, there are four tabs: "Name", "Time", "Language", and "Management Information". The "Name" tab is currently selected. Inside the dialog, there are two text input fields. The first is labeled "Name *" and contains the text "TS5200D4E1". The second is labeled "Description:" and contains the text "TeraStation". At the bottom of the dialog, there are two buttons: "OK" and "Cancel".

5 Click the *Time* tab.

Click *Use Local Date/Time* to use your computer's time settings for the TeraStation.

By default, the TeraStation adjusts its clock automatically by using a default NTP server. This NTP server belongs to Internet Multi Feed Inc. For more information, visit www.jst.mfeed.ad.jp.

To use a different NTP server, select *Name/Time/Language* from *Management*. Click *Time*, then *Edit*. Uncheck "Use Default NTP Server" and enter a new NTP IP address. Click *OK*.

If an NTP server is specified by name instead of IP address, make sure that a DNS server is configured for the TeraStation.

The screenshot shows the 'Name/Time/Language' dialog box with the 'Time' tab selected. The 'Date/Time Source' section has the 'Enable' radio button selected. The 'NTP IP Address' field contains 'ntp.jst.mfeed.ad.jp'. The 'Use Default NTP Server' checkbox is checked. The 'NTP Synchronization Frequency' dropdown is set to 'Daily'. The 'Disable' section is visible but not selected, showing a date of '12/17/2013' and a time of '14:06:18'. The 'Time Zone' dropdown is set to '(UTC+09:00) Osaka, Sapporo, Tokyo'. The dialog has 'OK' and 'Cancel' buttons at the bottom.

Note: The internal clocks of the TeraStation and other devices on your network may run at slightly different speeds. Over a long period of time your network devices may show somewhat different times, which can cause network problems. If clocks on your network vary by more than 5 minutes it may cause unexpected behavior. For best results, keep all clocks on the network set to the same time by adjusting them regularly, or use an NTP server to correct them all automatically.

- 6 Click the *Language* tab. Select the language to be used and click *OK*.

The screenshot shows the 'Name/Time/Language' dialog box with the 'Language' tab selected. The 'Character Encoding' dropdown is set to 'CP437'. The 'Display Language' dropdown is set to 'English'. The dialog has 'OK' and 'Cancel' buttons at the bottom.

Note: This tab changes the language used by the TeraStation for email notifications, DLNA, and other functions. To change the language displayed in Settings, go to Advanced Settings or Easy Admin and click *Language* in the menu bar. Choose your desired language from the drop-down menu.

Beep Alerts

You can set the TeraStation to beep when certain errors occur.

- 1 In Settings, click *Management*.

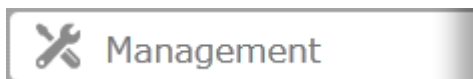

- 2 Click  to the right of "Notifications".



- 3 Click *Edit*.

- 4 Select the conditions to beep the alert, then click *OK*.

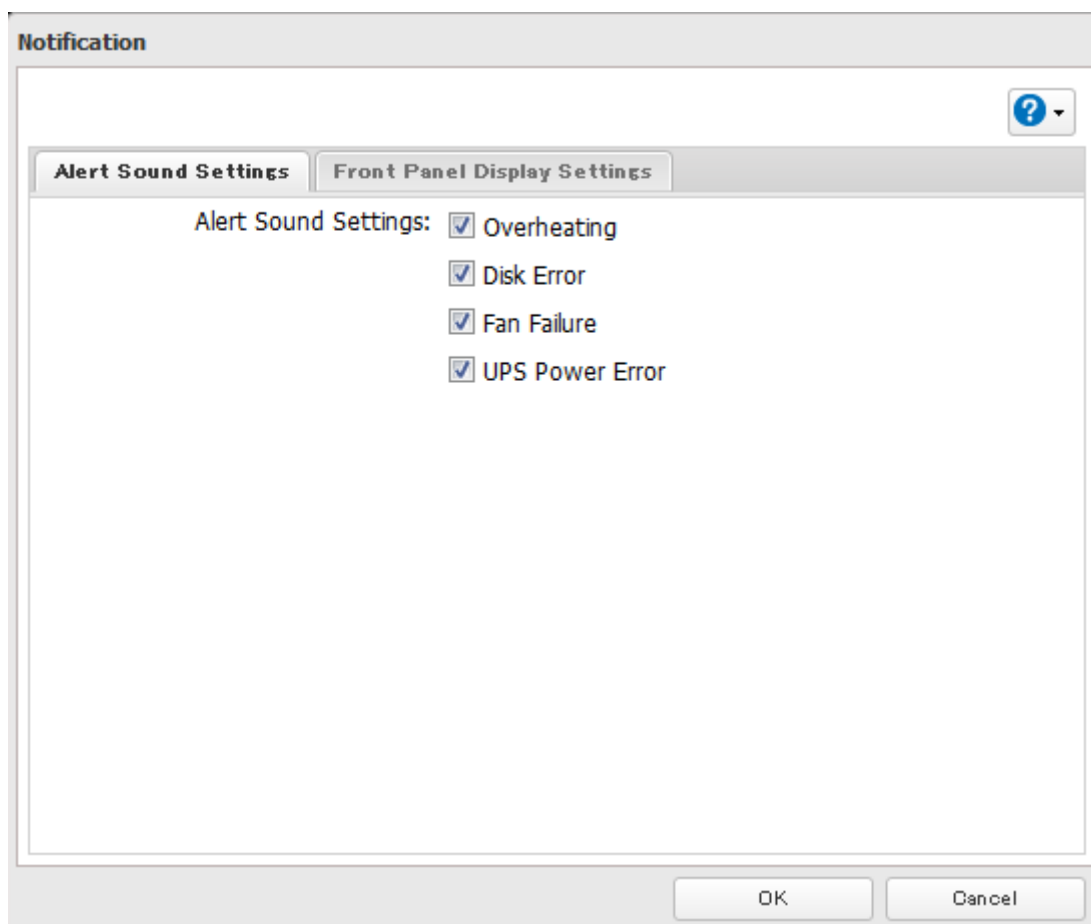

LCD and LEDs

You may configure the LEDs and LCD on the front of the TeraStation.

- 1 In Settings, click *Management*.



- 2 Click  to the right of "Notifications".



- 3 Click *Edit*.

- 4 Click *Front Panel Display Settings*.

- 5 Configure your settings, then click *OK*.

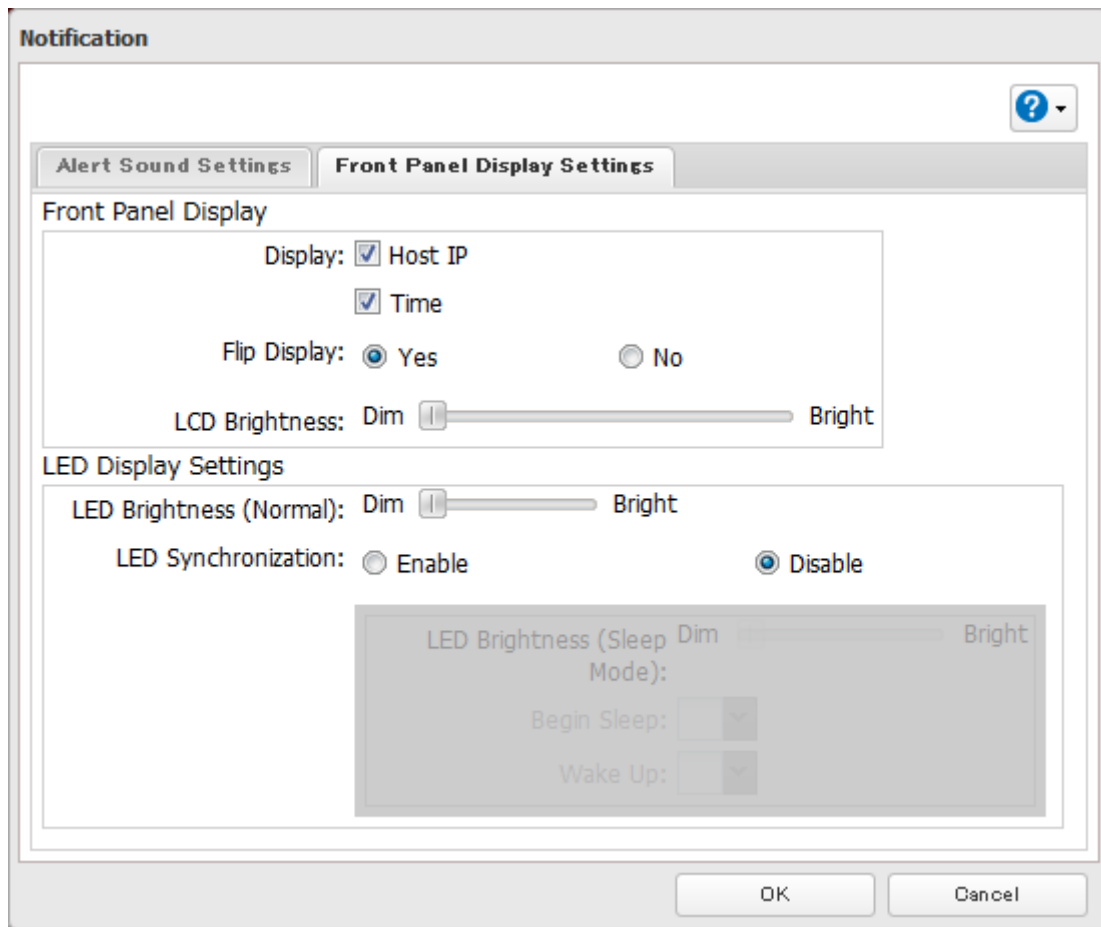

Jumbo Frames

If your other network devices support it, you may be able to increase network performance with jumbo frames.

- 1 In Settings, click *Network*.

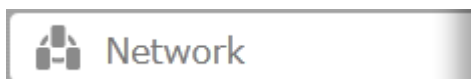

2 Click  to the right of "IP Address".

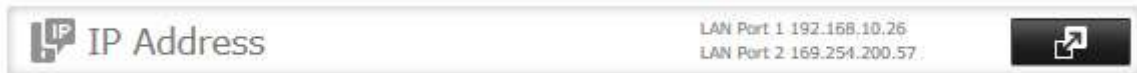

3 Click the LAN port where the jumbo frames will be used.

4 Select the desired Ethernet frame size and click OK.

IP Address Settings:LAN Port 1

* Required 

DHCP: Enable
 Disable

IP Address * : 192.168.10.30
Subnet Mask * : 255.255.255.0

Ethernet Frame Size: 1500  bytes

Ethernet frame sizes of 1500-9216 bytes are supported. The stated size doesn't include 14 bytes of header and 4 bytes of FCS. The default frame size is 1500 bytes. Frame sizes of 1501 bytes or more are considered jumbo frames.











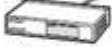

Network Settings

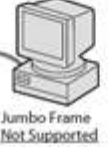
Wake on LAN: Enable
 Disable

Default Gateway Address: 192.168.10.1
Primary DNS Server: 192.168.10.1
Secondary DNS Server:

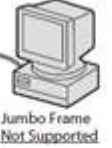
DHCP is enabled for LAN port 1.

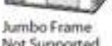
OK Cancel

Connection			Transmission	
 Jumbo Frame	 Jumbo Frame Supported	 Jumbo Frame Supported		Transmit Jumbo Frame
 Jumbo Frame	 Jumbo Frame Supported	 Jumbo Frame Not Supported		Transmit normally
 Jumbo Frame	 Jumbo Frame Not Supported	 Jumbo Frame Not Supported		Transmit normally
 Jumbo Frame	 Jumbo Frame Not Supported	 Jumbo Frame Supported		No transmission

Note: Make sure the TeraStation's Ethernet frame size is smaller than the hub or router's. Larger frame sizes may not transfer the data to the TeraStation correctly.

Changing the IP Address

Normally, the TeraStation's IP address is set automatically from a DHCP server on your network. If you prefer, you can set it manually. An easy way to do this is to change it from NAS Navigator2 running on a computer connected to the same router (subnet) as the TeraStation. The procedure to change the IP address in Settings is below.

Note: If the TeraStation is being used as an iSCSI hard drive, to change the settings, navigate to *Drives - iSCSI* in Settings and move the iSCSI switch to the  temporarily before changing network settings.

- 1 In Settings, click *Network*.

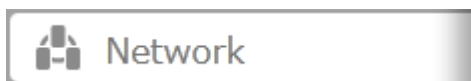

- 2 Click  to the right of "IP Address".



- 3 Click the LAN port where the IP address will be changed.

- 4** Disable "DHCP" and enter the desired network address settings, then click *OK*.

IP Address Settings:LAN Port 1

* Required ?

DHCP: Enable
 Disable

IP Address * : 192.168.10.30
Subnet Mask * : 255.255.255.0

Ethernet Frame Size: 1500 bytes

Ethernet frame sizes of 1500-9216 bytes are supported. The stated size doesn't include 14 bytes of header and 4 bytes of FCS. The default frame size is 1500 bytes. Frame sizes of 1501 bytes or more are considered jumbo frames.

Network Settings

Wake on LAN: Enable
 Disable

Default Gateway Address: 192.168.10.1
Primary DNS Server: 192.168.10.1
Secondary DNS Server:

OK Cancel

Notes:

- Do not set the same address for LAN port 1 and LAN port 2. This may cause unstable network communication.
- Use LAN port 1 to access different network subnets from the TeraStation. Access to a different network subnet is not possible from LAN port 2 since it doesn't have a default gateway.
- The following IP addresses are reserved and should not be used. If you configure one of them by accident, initialize all settings by referring to the "Restoring Factory Defaults" section in chapter 10.
 - Local loopback address: 127.0.0.1, 255.255.255.0
 - Network address: 0.0.0.0, 255.255.255.0
 - Broadcast address: 255.255.255.255, 255.255.255.0
 - The IP address range from 224.0.0.0 to 255.255.255.255

Chapter 11 Utilities

NAS Navigator2 for Windows

NAS Navigator2 is a utility program that makes it easy to display Settings, change the TeraStation's IP address, or check its hard drive. If you installed the TeraStation with the TeraNavigator CD, NAS Navigator2 was installed automatically.



Double-click the  icon to start NAS Navigator2.

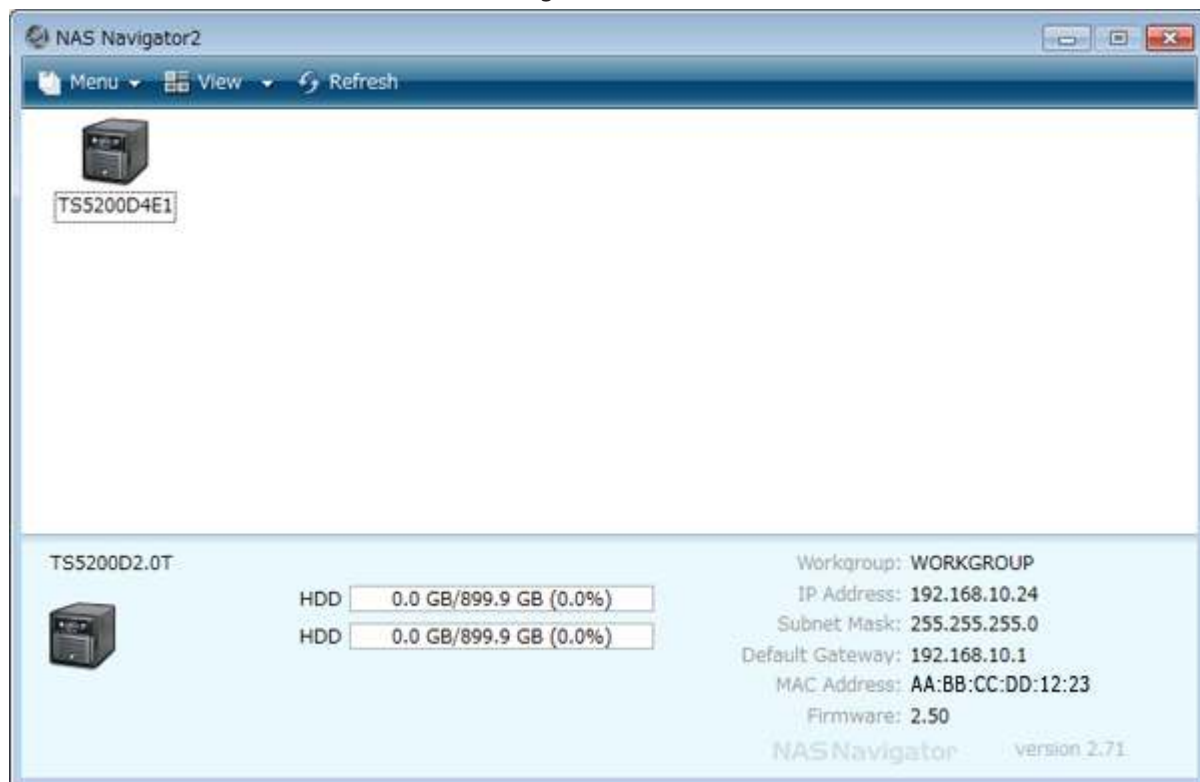

Click your TeraStation's icon to open a share on the TeraStation and display:

- Total capacity
- Capacity in use
- IP address
- Workgroup
- Subnet mask
- Default gateway
- MAC address
- Firmware version

Name		Description
Menu	Map Share*	Assigns the TeraStation's shared folder as a network drive.
	Disconnect Share*	Unmaps the network drive.
	Map All Remote Shares to Drive Letters	Assigns all the TeraStation's shared folders as network drives.
	Create Desktop Shortcut*	Creates a shortcut to the TeraStation's shared folder (share).
	Launch NAS Navigator2 on Startup	Launches NAS Navigator2 in the system tray when Windows boots.
	Display Errors	If an error occurs, an error message will pop up from the NAS Navigator2 icon in the system tray.
	Properties*	Opens the selected TeraStation's properties page.
	Close	Closes NAS Navigator2.
View	View	Icons: Displays icon. Details: Displays hostname, product name, workgroup, IP address, subnet mask, and default gateway.
	Sort by	Selects the sort order from following to display when multiple TeraStations are found: Hostname, product name, workgroup, IP address, subnet mask, default gateway
Browse*		Opens the TeraStation's shared folder.
Refresh		Searches for NAS devices on the network again.
I'm here*		Causes your TeraStation to beep.
Right-click your device's icon to show these options.	Browse Shares	Opens the TeraStation's shared folder.
	Settings	Opens Settings for the selected TeraStation.
	Properties	Opens the TeraStation's properties page.
	Map Share	Assigns the TeraStation's shared folder as a network drive.
	Disconnect Share	Unmaps the network drive.
	Create Shortcut	Creates a shortcut icon to the shared folder "share" on the desktop.
	I'm here	Causes your TeraStation to beep.

*Click on the TeraStation's icon to display these options.

When NAS Navigator2 is minimized, right-click on the NAS Navigator2 icon in the system tray for the following options.

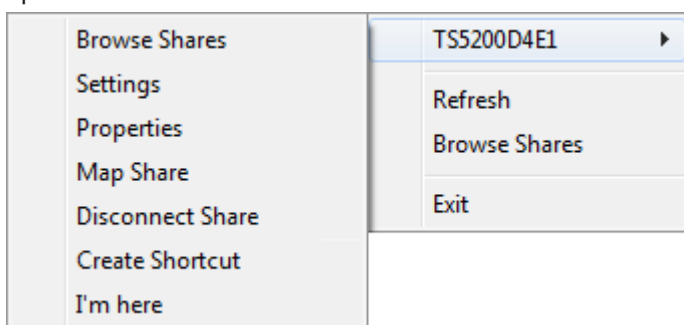

Name		Description
TeraStation Name	Browse Shares	Opens the TeraStation's shared folder.
	Settings	Opens Settings for the selected TeraStation.
	Properties	Opens the TeraStation's properties page.
	Map Share	Assigns the TeraStation's shared folder as a network drive.
	Disconnect Share	Unmaps the network drive.
	Create Shortcut	Creates a shortcut icon to the shared folder "share" on the desktop.
	I'm here	Causes your TeraStation to beep.

Name	Description
Refresh	Refreshes list of NAS devices.
Browse Shares	Displays NAS Navigator2 window.
Exit	Exits NAS Navigator2.

The following tasks may be performed from the TeraStation's properties page.

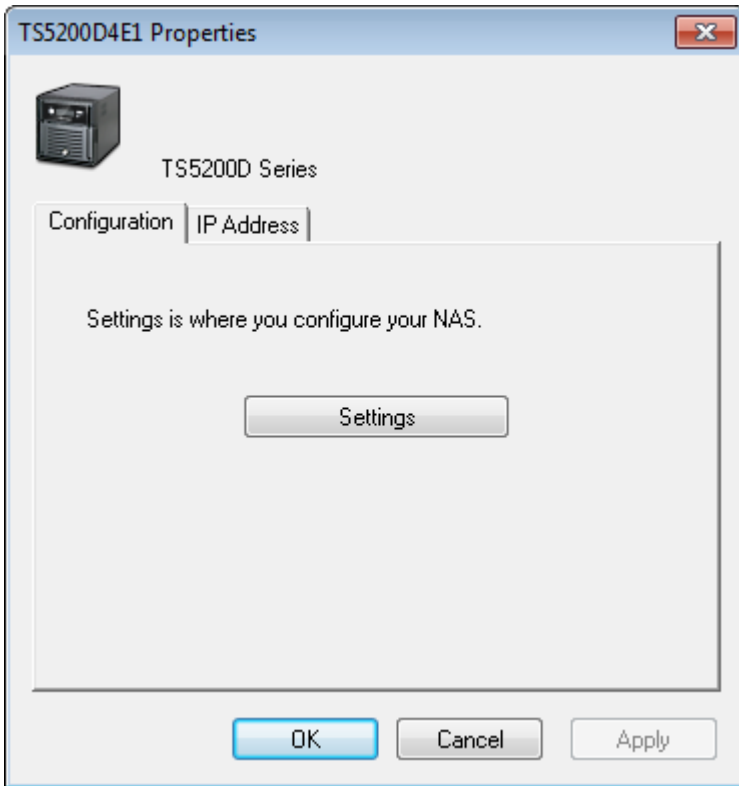

Name	Description
Configuration	Click <i>Settings</i> to open the configuration interface.
IP Address	Check <i>Use DHCP</i> to assign an IP address from the DHCP server automatically. If there is no DHCP server in the network, you cannot use this function. Check <i>Renew IP address</i> to obtain an IP address from the DHCP server. You can manually enter an IP address, subnet mask, and default gateway.

Mount as Network Drive

You can easily map a shared folder as a network drive using NAS Navigator2.

- 1 Double-click the  icon on to start NAS Navigator2.

- 2 Right-click on the TeraStation's icon, then click *Map Share*.

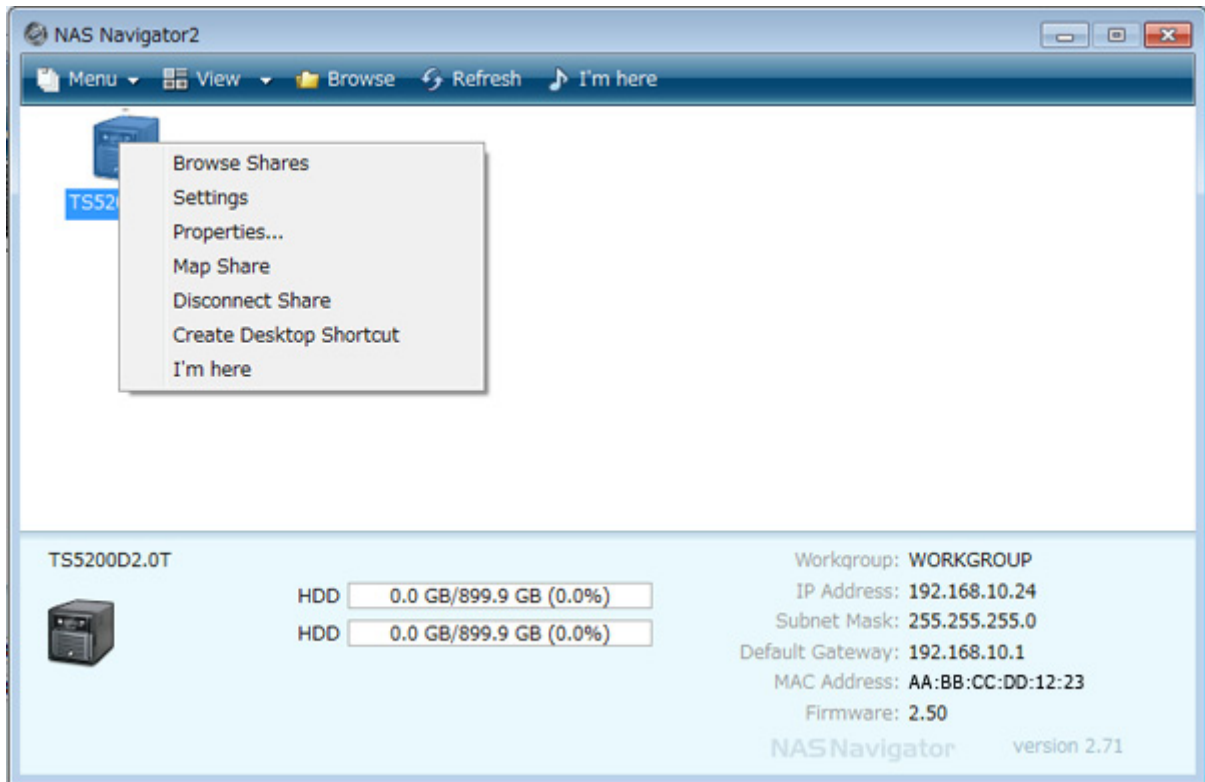

- 3 An icon for the mapped share will appear in Computer or My Computer. You can use this network drive just like any other hard drive.



Changing the IP Address



- 1 Double-click the  icon to start NAS Navigator2.
- 2 Right-click on your TeraStation's icon and choose *Properties - IP Address*.

- 3** Uncheck "Use DHCP" and enter the desired settings, then click *OK*. If the username and password prompt appears, enter the admin username and password.

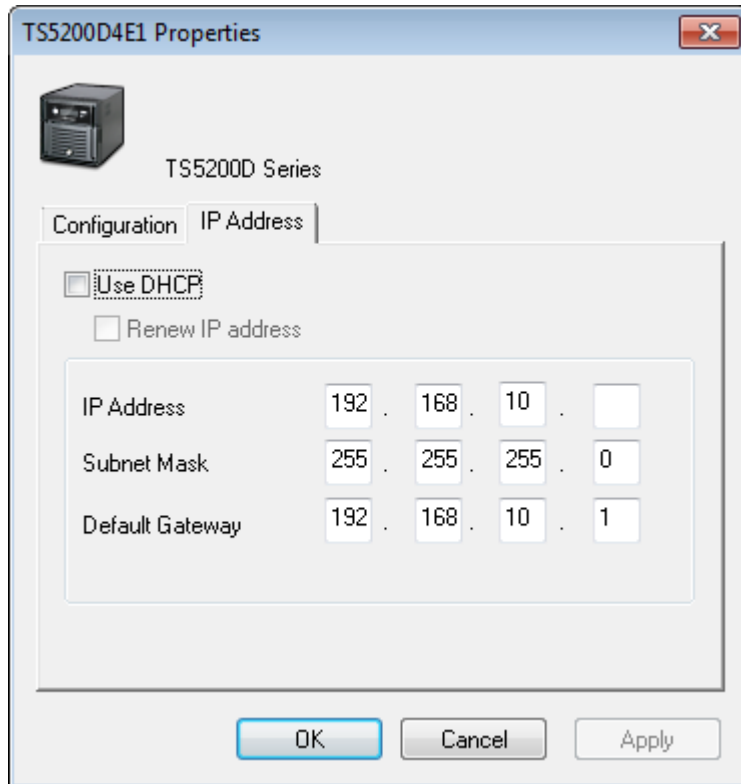

Note: The following IP addresses are reserved and should not be used. If you configure one of them by accident, initialize all settings by referring to the "Restoring Factory Defaults" section in chapter 10.

Local loopback address: 127.0.0.1, 255.255.255.0
Network address: 0.0.0.0, 255.255.255.0
Broadcast address: 255.255.255.255, 255.255.255.0
The IP address range from 224.0.0.0 to 255.255.255.255

NAS Navigator2 for Mac

NAS Navigator2 is a utility program that makes it easy to display Settings, change the TeraStation's IP address, or check its hard drive.

If you installed the TeraStation with the TeraNavigator CD, NAS Navigator2 was installed automatically. To launch it,



click the icon in the Dock.

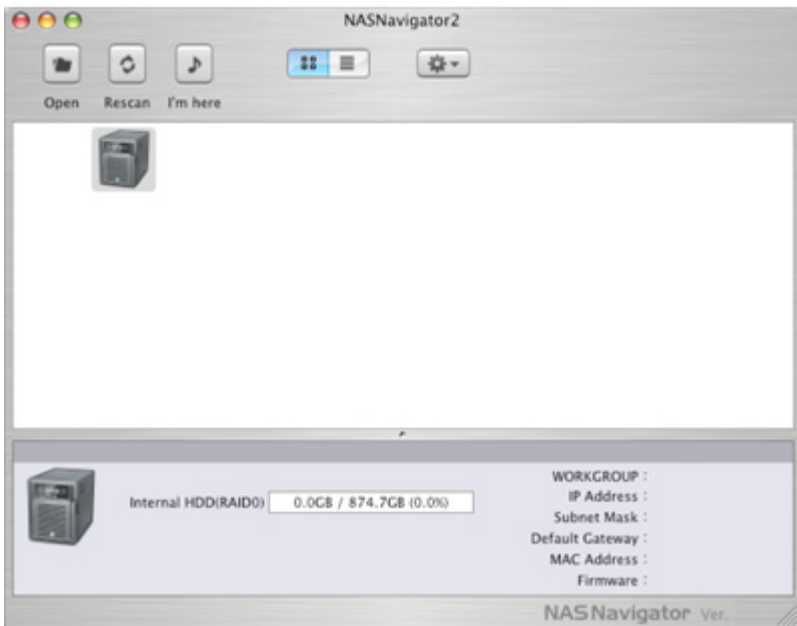

Click on a TeraStation's icon to display:

- Total capacity
- Used capacity
- Workgroup
- IP address
- Subnet mask
- Default gateway
- MAC address
- Firmware version

Double-click it to open a share on the TeraStation.

Name	Description	
Open	Opens the default shared folder for a selected TeraStation.	
Refresh	Searches for NAS devices on the network again.	
I'm here	Causes your TeraStation to beep.	
Settings	Opens Settings for the selected TeraStation.	
Configure	Opens a window that lets you configure NAS's IP address or open Settings.	
Label Color	Selects the color of the name displayed below the icon.	
View Options	Lets you choose icon size, position, and view mode.	
Auto Power Mode	Auto power mode can turn supported TeraStations and LinkStations on the network on and off automatically.	
To display these options, hold down the control key and select your TeraStation's icon.	Open Folder	Opens the TeraStation's shared folder.
	Settings	Opens Settings for the selected TeraStation.
	Configure	Opens a window that lets you change the NAS's IP address or open Settings.
	I'm here	Causes your TeraStation to beep.
	Label Color	Selects the color of the name displayed below the icon. The menu below is displayed when you click the TeraStation icon while holding down the control key.

Mount as Network Drive

You can map a shared folder as a network drive using NAS Navigator2 on Mac OS.

- 1 Click the  icon in the Dock to start NAS Navigator2.
- 2 Double-click the TeraStation icon or click the TeraStation icon while holding down the control key, then select *Open Folder*. Enter a username and password with the rights to access the shared folder.

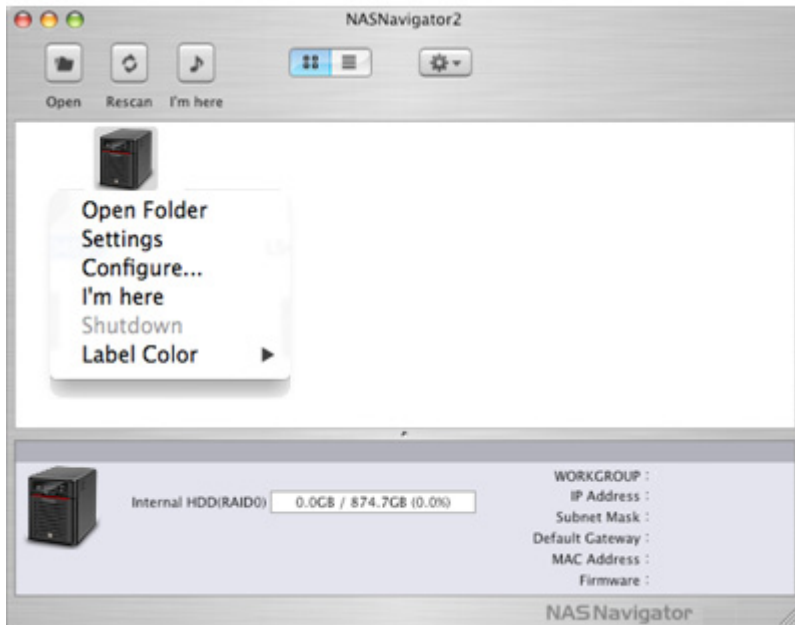

- 3 Select the shared folder that you want to mount, then click *OK*.
- 4 The shared folder is now mounted as a network drive.

Changing the IP Address

- 1 Click the  icon in the Dock to start NAS Navigator2.
- 2 Click the TeraStation icon while holding down the control key, then choose *Configure - IP Address*.

- 3** Uncheck "Use DHCP"; enter the desired settings and the administrator password, then click *Apply*.

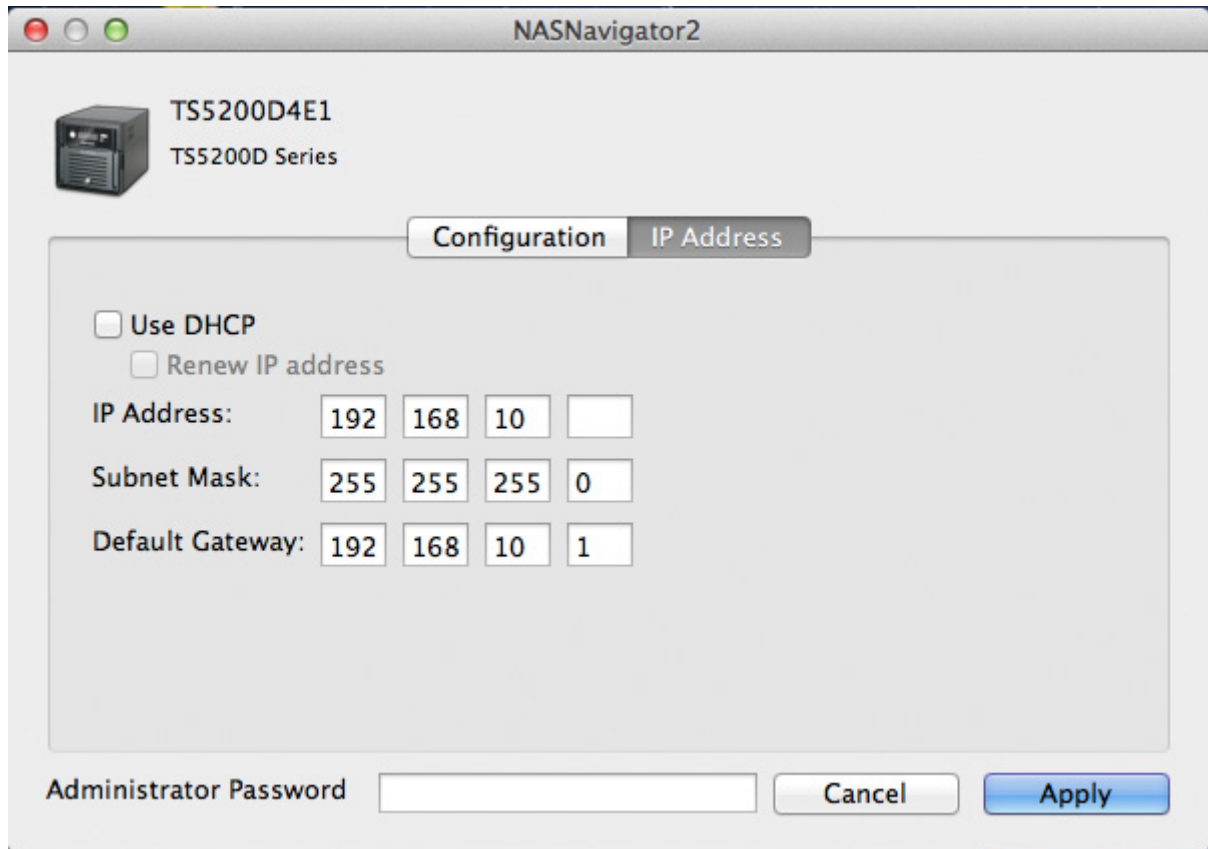

Note: The following IP addresses are reserved and should not be used. If you configure one of them by accident, initialize all settings by referring to the "Restoring Factory Defaults" section in chapter 10.

- Local loopback address: 127.0.0.1, 255.255.255.0
- Network address: 0.0.0.0, 255.255.255.0
- Broadcast address: 255.255.255.255, 255.255.255.0
- The IP address range from 224.0.0.0 to 255.255.255.255

iSCSI Connection Tool

The iSCSI Connection Tool is a Windows utility that lets you use the TeraStation as an iSCSI drive.

Note: If using TS5000N series TeraStation models, this software is not included with the TeraNavigator software and cannot be installed from it.

To launch it, click *Start - All Programs - BUFFALO - iSCSI Connection Tool - iSCSI Connection Tool*.

For Windows 8.1 and Windows 8, click *iSCSI Connection Tool*.

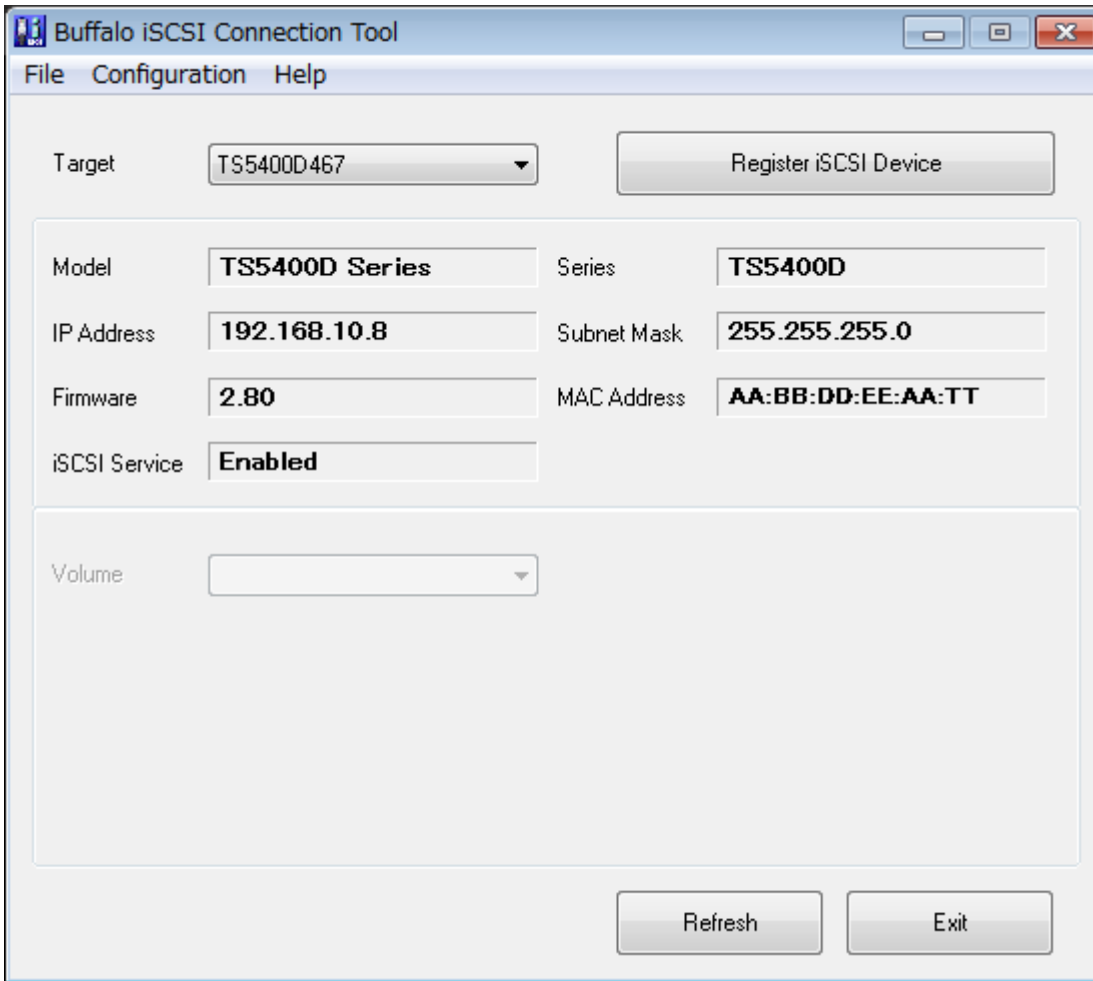

Home Screen

Name	Description
Target	If a TeraStation is selected, clicking <i>Register iSCSI Device</i> will register all the volumes in the TeraStation to the computer for enabling connection to individual volumes. If a volume is already registered, click <i>Unregister iSCSI Device</i> to unregister all volumes, disconnecting them from the TeraStation.
Model	Displays TeraStation's model name.
Series	Displays TeraStation's series name.
IP Address	Displays TeraStation's IP address.
Subnet Mask	Displays TeraStation's subnet mask.
Firmware	Displays TeraStation's firmware version.
MAC Address	TeraStation's MAC address.
iSCSI Service	Shows whether the iSCSI service of the TeraStation is running or stopped.
Volume	Select individual volumes from a registered TeraStation. Select a volume and click <i>Connect</i> , then the selected volume will be recognized as a local drive in My Computer on your computer. If a volume is connected, click <i>Unregister</i> to disconnect it.
Current status	Displays current status of the selected volume. - Disconnected: Volume is disconnected. - Connected: Volume is connected. - Connected to another PC: Volume is connected to another computer. Displays the other computer's IP address.

Name	Description
User authorization	- Disabled:No authentication. - Enabled:User authentication is needed to connect to a volume.
Connect on Start Up	If selected, the computer will connect to the volume automatically at boot.
Refresh	Search for network devices on the LAN.
Exit	Exit iSCSI Connection Tool.

Menu

Name		Description
File	Refresh	Search for network devices on the LAN.
	Exit	Closes the iSCSI Connection Tool.
Setup	Configuration	Opens Settings for the selected TeraStation.
	Change IP address	You can change the IP address of the selected TeraStation.
	Unregister iSCSI device	If you disconnect the TeraStation without unregistering it or changing its IP address, the registration information stays in your computer and searches will take longer. For better performance, unregister disconnected TeraStations with this command.
	Set mutual CHAP secret	Set the CHAP password on the computer side.
	Persistent Volume	If checked, your computer will reconnect to the TeraStation whenever it's restarted.
	Connect volumes	Connect multiple volume at a time.
	Disconnect volumes	Displays the screen to disconnect multiple volume at a time.
	Disk management	Format drives.
Help	About	Displays version information.

NovaBACKUP

NovaBACKUP is a Windows utility that lets you back up the data on your computer or TeraStations.

- 1** Insert the TeraNavigator CD into your computer. TeraNavigator will launch.
- 2** Click *Options - Additional Software Installation*.
- 3** Select "NovaBackup" and click *Install*.
- 4** Click *Install* again.
- 5** Check "Backup Client" and click *Install* on the NovaBackup installation wizard.
- 6** Select the installation language and click *Next* twice.
- 7** Check on "I accept the terms in the License Agreement", then click *Next*.
- 8** Select "Typical", then click *Next*.
- 9** Enter your name, company name, and email address. Select "I have a license key" and click *Next*.

Notes:

- Name, company name, and email address are required.
- Don't change the license key which is displayed on the screen.

10 Click *Finish*.

NovaBACKUP is now installed. To launch NovaBACKUP, click the icon on your computer's desktop. For more detailed information, click *View Help* in the NovaBACKUP Express Wizard or click *Help Topics* at the upper right of the NovaBACKUP home screen.

Chapter 12 Appendix

LCD Display

The LCD display can be cycled through different modes by pressing the display button on the front of the TeraStation. Also, the items displayed can be configured at *Management - Notifications - Front Panel Display Settings* in Settings.

Modes

LCD Message		Description	Corrective Action
LINK SPEED Note: When an Ethernet cable is connected to LAN Port 2, "LINK SPEED 2" is displayed.	LINK SPEED No LINK	Not connected to network.	Connect an Ethernet cable to the LAN port.
	LINK SPEED 10 Mbps HALF	Connected at 10 Mbps half duplex.	-
	LINK SPEED 10 Mbps FULL	Connected at 10 Mbps full duplex.	-
	LINK SPEED 100 Mbps HALF	Connected at 100 Mbps half duplex.	-
	LINK SPEED 100 Mbps FULL	Connected at 100 Mbps full duplex.	-
	LINK SPEED 1000 Mbps	Connected at 1000 Mbps full duplex.	-
Series Name / Firmware Version	TS5400D Ver. x.xx	Displays the series name and the firmware version. Note: This is an example for 4-drive TeraStation models. Depending on the unit model you are using, the series name may be displayed differently.	-
Hostname / IP Address	TSxxxxx xxx 192.168.11.150	Displays the hostname and IP address. At the end of the IP address, F (fixed IP address) or D (IP address automatically acquired from a DHCP server) is displayed. Note: When an Ethernet cable is connected to LAN port 2, "NETWORK2" is displayed in the hostname section.	-
Calendar / Clock	DATE TIME 2012/1/1 11:11	Displays the date and time set in the TeraStation.	-

Errors

LCD Message	Description	Corrective Action
BOOT FAIL	Hard drive not found.	Contact Buffalo technical support for assistance.
SYSTEM Error E04 Can't Load Krnl!	The firmware is corrupted.	Contact Buffalo technical support for assistance.

LCD Message	Description	Corrective Action
UPS E10 Dependent Mode	The TeraStation is running on the UPS battery due to a power outage. The system will now be shut down safely.	Check that power is being supplied to the UPS, and if there are no problems, turn on the TeraStation.
SYSTEM Error E11 Fan Failure	An error occurred in the fan speed.	Check that no foreign objects or dust are clogging the fan. If any foreign objects or dust are found, use a pair of tweezers, air duster, or other tool to remove them. If the error is displayed again, contact Buffalo technical support for assistance.
SYSTEM Error E12 Cooling Failure	A rise in the system temperature may have exceeded the allowable safety value.	Do not place objects in the area around the TeraStation. Also, move the TeraStation to a cool location.
RAID Arrayx E14 Can't Mount	RAID array x cannot be mounted.	Run the RAID array disk check in Settings.
HDx Error E16 HDx Not Found	Unable to find hard drive x.	Hard drive x may be disconnected or may have failed. After shutting down, reinstall the hard drive.
HDx Error E22 HDx Can't Mount	Unable to mount drive x.	Format the hard drive. After formatting, if the error still appears after rebooting, replace the hard drive. If the error is displayed again, contact Buffalo technical support for assistance.
FailOver E27 LostBackupTarget	Unable to find the backup TeraStation.	In the main TeraStation's settings, navigate to <i>Backup - Failover</i> to reconfigure the backup TeraStation for failover.
HDx Broken E30 Replace the DISK	An error occurred, so hard drive x was removed from the RAID array.	Replace hard drive x.

Status

After you change settings or format a hard drive, the current status is displayed on the LCD.

LCD Message	Description	Corrective Action
SYSTEM I10 TOO HOT!	System temperature is too high.	Move the TeraStation to a cool location. Do not place objects in the area around the TeraStation.
HDx Warning I11 Bad Sectors	Drive x has too many bad sectors.	Replace hard drive x.
Operation I12 DEGRADE MODE	Operating in degraded mode.	-
RAID I13 ARRAYxFormatting	Formatting RAID array x.	-
RAID I14 ARRAYx Checking	Checking RAID array x.	-
RAID I15 ARRAYx Scanning	Examining the error status of RAID array x. Note: Transfer speeds are slower during the examination process.	-
RAID I16 ARRAYx Creating	Creating RAID array x.	-
RAID I17 ARRAYx Resyncing	Resynchronizing RAID array x. Note: Transfer speeds are slower during resynchronization.	-

LCD Message	Description	Corrective Action
RAID I18 ARRAYx Rebuilding	Rebuilding RAID array x. Note: Transfer speeds are slower during the rebuilding process.	-
RAID I19 ARRAYx 0 Filling	Writing 0s to RAID array x, erasing all data.	-
RAID I20 DISKx Formatting	Formatting hard drive x.	-
RAID I21 DISKx Checking	Checking hard drive x.	-
RAID I22 DISKx 0 Filling	Erasing the data for hard drive x.	-
SYSTEM I25 F/WUPDATING	Updating the TeraStation firmware. Note: Do not turn off the power during the updating process.	-
Web Setting I26 Initializing	Initializing all settings.	-
USB Diskx I27 Checking	Checking USB hard drive x.	-
USB Diskx I28 Formatting	Formatting USB hard drive x.	-
Press FuncSW I31 New Diskx ready	Displayed when pressing the Function button to rebuild the RAID after replacing hard drive x.	Press the Function button to rebuild the RAID array.
Set From Web I32 New Diskx ready	Displayed after replacing hard drive x when the RAID needs to be rebuilt in Settings or formatting is necessary.	In Settings, either rebuild the RAID array or format the hard drive.
Replication I33 ReplicateFailure	An error occurred in replication, or synchronization between the main TeraStation and the backup TeraStation failed during failover configuration.	In Settings, navigate to <i>Backup - Replication</i> and choose "Resync" to execute resynchronization. If the error is displayed again, contact Buffalo technical support for assistance.
Virus alert I34 Virus detected	A virus scan found a virus.	Once the virus is removed from the quarantine folder, the message is no longer displayed. If the antivirus software is configured to delete viruses from the quarantine folder automatically, then the message will not be displayed.
Cartridgex I35 Location error	A hard drive set as a media cartridge has been installed in the drive x slot.	Connect to the slot that was set as a media cartridge.
Cartridgex I36 Decryption error	Media cartridge cannot be decrypted. The media cartridge may have been encrypted by a TeraStation other than this product.	Connect to the TeraStation that performed encryption to decrypt.
Recovery I37 SystemRecovering	System recovery in progress.	-
Recovery I38 RecoveryFinished	System recovery is complete.	-
Recovery I39 Change Boot	System recovery from the USB recovery device is complete.	Change the boot mode switch on the rear to HDD.
Recovery I40 DataWillDeleted	Beginning recovery. All data in the drive 1 will be deleted.	-
Recovery I41 PushFuncToStart	Pressing the function button on the front will start the recovery process.	-

LCD Message	Description	Corrective Action
Recovery I42 Preparing	Preparing to start the recovery process.	-
Recovery I43 Unsupported HW	The TeraStation was started from the USB recovery device, but the system cannot be recovered from this USB recovery device.	-
Recovery I44 Disk1 not found	Recovery from the USB recovery device was initiated, but drive 1 was not detected.	Make sure that drive 1 is present and fully inserted in its slot.
Recovery I45 Recovery Failed	Recovery failed.	-
RAID ARRAY I46 RMM+Processing	Data migration or conversion (RAID migration) is in progress.	Do not turn off the TeraStation power.
SYSTEM I47 Don't Power Off		
FailOver I48 PushFuncToStart	This TeraStation is ready to become the failover backup for the main TeraStation.	Hold down the function button on the front of the target TeraStation until it stops beeping to accept failover backup status.
FailOver I49 LostMainTarget	The main TeraStation in the failover configuration cannot be found.	Make sure that the main TeraStation is on, working, and connected to the network.
FailOver I50 Maintenance mode	Failover maintenance is in progress.	Do not turn off the TeraStation power.
FailOver I51 Initializing	Initializing the failover configuration.	Do not turn off the TeraStation power.
New Firmware I52 Available	A new firmware version has been released.	Update the firmware.
BackupTask xx I54 Backup Failure	xxth backup task failed.	Make sure that the backup job is configured correctly. Make sure that the NAS is on and not in standby mode. If the backup job still fails, check the status of NAS, network, and backup source and destinations.
Recovery I55 RecoveryAuthFail	Authentication during recovery of settings failed.	Settings can only be restored for the TeraStation whose settings were originally saved. To restore settings, insert the USB memory device, move the Boot Mode switch on the rear of the TeraStation to the USB position, and restart the TeraStation. Or, settings can be restored in Settings with the TeraStation powered on.
Surveillance I56 Lack of License	There are not enough surveillance camera server licenses.	Purchase and register an additional license.
Surveillance I57 No free space	There is not enough space to save additional surveillance video.	Delete or move some of the stored video.
Surveillance I58 Recording Failure	Video not recorded.	Check your settings. Also, use the utilities provided with your camera to check that the camera is operating correctly.

Default Settings

Administrator's Name	admin
Password	password

Shared Folders	"share" (for both Windows and Mac computers). The recycle bin is enabled on "share" by default.
DHCP Client	Normally, the TeraStation will get its IP address automatically from a DHCP server on the network. If no DHCP server is available, then an IP address will be assigned as follows: IP Address: 169.254.xxx.xxx (xxx is assigned randomly when booting the TeraStation.) Subnet Mask: 255.255.0.0
Registered Groups	"hdusers", "admin", and "guest" You cannot edit or delete these default groups.
Microsoft Network Group Settings	WORKGROUP
Ethernet Frame Size	1500 bytes (not including 14 bytes of header and 4 bytes of FCS)
AFP	Enabled
FTP	Disabled
NTP	Enabled
Print Server	Enabled
WebAccess	Disabled
Time Machine	Disabled
TeraSearch	Disabled
RAID Mode	8-drive, 6-drive, and 4-drive models: RAID 5 2-drive models: RAID 1

Specifications

Check the Buffalo website for information about the latest products and specifications.

LAN Port	Interface	IEEE 802.3ab (1000BASE-T) IEEE 802.3u (100BASE-TX) IEEE 802.3 (10BASE-T)
	Transfer Speed	1000 Mbps full duplex (auto-negotiation) 100 Mbps full duplex/half duplex (auto-negotiation) 10 Mbps full duplex/half duplex (auto-negotiation)
	Number of Ports	2 ports (supports Auto-MDIX)
	Connector Type	RJ-45 8-pin
	Protocol	TCP/IP
	Access Method	CSMA/CD
	File Sharing	SMB/CIFS, AFP, FTP/SFTP, NFS, HTTP/HTTPS
	Management	HTTP/HTTPS
	Jumbo Frames	1500, 4084, 7404, and 9216 byte modes are supported. (not including 14 bytes of header and 4 bytes of FCS)
USB Port	8-drive models, 6-drive models, and 4-drive rackmount models: USB 2.0 Port (Series A) x 2, USB 3.0 Port (Series A) x 3 4-drive desktop models and 2-drive models: USB 2.0 Port (Series A) x 2, USB 3.0 Port (Series A) x 2 Note: Supported USB devices include Buffalo USB hard drives, USB UPS devices, and printers.	
UPS Port	UPS Port (D-SUB 9 pin (Male)) x 1 Note: Compatible UPS are manufactured by Omron or APC.	

Internal Hard Drive	If a hard drive in the TeraStation malfunctions, replace it with a Buffalo drive of the same capacity. Use a Buffalo OP-HDWR series drive for the TS5200DS, TS5000WR, and TS5000N series, a OP-HDH series drive for the TS5400RH, and a OP-HDS series drive for other TS5000 series TeraStations. The drives listed above are available from the Buffalo website.
Power Supply	AC 100–240 V, 50/60 Hz
Dimensions (D x W x H)	8-drive models: 230 x 300 x 215 mm; 9.1 x 11.8 x 8.5 in 6-drive models: 230 x 170 x 260 mm; 9.1 x 6.7 x 10.2 in 4-drive desktop models: 230 x 170 x 215mm; 9.1 x 6.7 x 8.5 in 4-drive rackmount models: 430 x 45 x 430 mm; 16.9 x 1.7 x 16.9 in 2-drive models: 230 x 170 x 170 mm; 9.1 x 6.7 x 6.7 in
Weight	8-drive models: Approx. 12.0 kg; 26.5 lb 6-drive models: Approx. 10.0 kg; 22.1 lb 4-drive desktop models: Approx. 7.5 kg; 16.5 lb 4-drive rackmount models: Approx. 9.0 kg; 19.8 lb 2-drive models: Approx. 4.0 kg; 8.8 lb
Power Consumption (Max.)	8-drive models: 170 W 6-drive models: 120 W 4-drive desktop models: 86 W 4-drive rackmount models: 140 W 2-drive models: 47 W
Operating Environment	Temperature: 5–35°C; 41–95°F Environment Humidity: 20–80% (no condensation)
Compatibility	Windows PCs, Macs, and tablets with wired or wireless Ethernet connection. Note: The TeraStation requires a network connection with your computer for operation. It cannot be connected via USB.
Supported OS	Windows 8.1*, Windows 8*, Windows 7*, Windows Vista*, Windows XP, Windows XP Media Center Edition (2004 or 2005), Windows Server 2012, Windows Server 2008 R2, Windows Server 2008, Windows Server 2003 R2, Windows Server 2003, Windows 2000 Server**, Windows RT 8.1, Windows RT OS X 10.10, 10.9, 10.8, 10.7, 10.6, 10.5, 10.4**, 10.3.9** *32-bit and 64-bit **TS5000 series only.

Chapter 13 Regulatory Compliance Information

For Customers in the United States

FCC Statement

This equipment has been tested and found to comply with the limits for a Class A digital device, pursuant to part 15 of the FCC Rules. These limits are designed to provide reasonable protection against harmful interference when the equipment is operated in a commercial environment. This equipment generates, uses, and can radiate radio frequency energy and, if not installed and used in accordance with the instruction manual, may cause harmful interference to radio communications. Operation of this equipment in a residential area is likely to cause harmful interference in which case the user will be required to correct the interference at his own expense.

This device complies with Part 15 of the FCC Rules. Operation is subject to the following two conditions: (1) This device may not cause harmful interference, and (2) this device must accept any interference received, including interference that may cause undesired operation.

Only use the cables and accessories that are included in the package. Don't use other accessories or cables unless specifically instructed to in the documentation.

UL and MET

CAUTION: Slide/rail mounted equipment is not to be used as a shelf or a work space.

Ne déposez jamais des instruments au dessus de l'appareil et ne l'utilisez jamais comme un tiroir.

For Customers in Europe

EU Declaration of Conformity



Dansk

Dette er et Klasse A-produkt. I et hjemmemiljø kan dette produkt skabe radiointerferens, hvormed det kan være nødvendigt for brugeren at tage passende forholdsregler.

Der må kun bruges de kabler og det tilbehør der er inkluderet i pakken. Der må ikke bruges andet tilbehør eller kabler, medmindre det er udtrykkeligt beskrevet i dokumentationen.

Brug ikke USB-kabler, der er 3 meter eller længere for at tilslutte USB enheder til denne TeraStation serie.

Deutsch

Dies ist ein Produkt der Klasse A. In einer häuslichen Umgebung kann dieses Produkt Funkstörungen verursachen. Um diese zu beheben, müssen ggf. entsprechende Maßnahmen ergriffen werden.

Verwenden Sie ausschließlich die Kabel und Zubehörteile, die im Lieferumfang enthalten sind. Andere Zubehörteile oder Kabel dürfen nur dann verwendet werden, wenn dies in der Dokumentation ausdrücklich vorgeschrieben ist. Verwenden Sie keine USB-Kabel, die 3 Meter lang oder länger sind, um USB-Geräte an TeraStation dieser Serie anzuschließen.

English

This is a Class A product. In a domestic environment, this product may cause radio interference, in which case the user may be required to take adequate measures.

Only use the cables and accessories that are included in the package. Don't use other accessories or cables unless specifically instructed to in the documentation.

Do not use USB cables that are 3 meters or longer to connect USB devices to this TeraStation series.

Español

Este es un producto de Clase A. En una situación domestica, este producto puede producir interferencias de radio, en ese caso el usuario deberá tomar las medidas adecuadas.

Utilice únicamente los cables y accesorios incluidos en el paquete. No utilice otros accesorios ni cables a menos que así se indique en la documentación.

Utilice cables de una longitud inferior a 3 metros para conectar los dispositivos USB a este tipo de TeraStation.

Français

Cet appareil est un produit de Classe A. Dans un environnement domestique, ce produit est susceptible de provoquer des interférences radio, auquel cas l'utilisateur peut être mis en demeure de prendre des mesures appropriées.

Utilisez uniquement les câbles et accessoires inclus dans ce package. N'utilisez aucun autre accessoire ou câble sauf instruction spécifique de la documentation.

Utilisez des câbles d'une longueur de moins 3 mètres pour connecter les périphériques USB à ce type de TeraStation.

Italiano

Questo è un prodotto di Classe A. In ambienti domestici il prodotto può causare radiointerferenza, nel qual caso potrebbe rendersi necessaria l'adozione di opportune misure.

Utilizzare esclusivamente i cavi e gli accessori inclusi nell'imballaggio. Non utilizzare altri accessori o cavi a meno che non sia specificamente indicato nella documentazione.

Non utilizzare cavi USB lunghi 3 metri o più per collegare dispositivi USB a questa TeraStation.

Nederlands

Dit is een Klasse A product. Dit product kan in een huishoudelijke omgeving radiostoring veroorzaken in welk geval de gebruiker adequate maatregelen dient te nemen.

Gebruik alleen de kabels en toebehoren die zich in de verpakking bevinden. Gebruik geen ander toebehoren of kabels tenzij dit uitdrukkelijk in de handleiding wordt aangegeven.

Gebruik geen USB-kabels die 3 meter of langer zijn om USB-apparaten met deze TeraStation series te verbinden.

Norsk

Dette er et produkt i klasse A. I et hjemmemiljø kan dette produktet forårsake radiointerferens, noe som gjør at brukeren i så fall må foreta passende tiltak.

Bruk kun kabler og tilbehør som er inkludert i pakken. Ikke bruk annet tilbehør eller kabler med mindre spesielt instruert til å gjøre det i dokumentasjonen.

Bruk ikke USB-kabler på tre meter eller mer for å koble USB-enheter til denne TeraStation-serien.

Português

Este é um produto de Classe A. Num ambiente doméstico, este produto pode provocar interferências de rádio, pelo que o utilizador poderá ter de tomar medidas adequadas.

Utilizar apenas cabos e acessórios incluídos na embalagem. Não utilizar outros acessórios ou cabos, salvo se especificamente indicado na documentação.

Não usar cabos USB de 3 metros ou mais para ligar dispositivos USB a esta série TeraStation.

Suomi

Tämä on luokan A tuote. Tämä tuote voi aiheuttaa radiohäiriöitä kotikäytössä, jolloin käyttäjän on ehkä ryhdyttävä tarvittaviin toimenpiteisiin.

Käytä ainoastaan pakkauksen mukana toimitettuja kaapeleita ja varusteita. Älä käytä muita varusteita tai kaapeleita ellei näin ole erityisesti ohjeistettu asiakirjoissa.

Älä käytä 3m tai pitempiä USB-kaapeleita USB-laitteiden liittämiseen näille TeraStation-sarjoille.

Svensk

Detta är en Klass A-produkt. I en hushållsmiljö kan denna produkt orsaka radiostörningar, och användaren kan i så fall begäras att vidta lämpliga åtgärder.

Använd bara kablar och tillbehör som ingår i förpackningen. Använd inte andra tillbehör eller kablar om du inte får uttryckliga instruktioner om det i dokumentationen.

Använd inte USB-kablar som är 3 meter eller längre för att ansluta USB-enheter till den här TeraStation-serien.

Türk

Bu, A Sınıfı bir üründür. Evde kullanım sırasında bu ürün radyo girişimine yol açabilir ve bu durumda kullanıcının gerekli önlemleri alması gerekebilir.

Yalnızca pakette bulunan kablo ve aksesuarları kullanın. Belgelerde özellikle belirtilmedikçe başka aksesuar ve kablolar kullanmayın.

USB aygıtları bu TeraStation serisine bağlamak için 3 metre ve daha uzun USB kabloları kullanmayın.

CB

Norsk

Utstyr som er koplet til beskyttelsesjord via nettplugg og/eller via annet jordtilkoplet utstyr – og er tilkoplet et kabel-TV nett, kan forårsake brannfare.

For å unngå dette skal det ved tilkopling av utstyret til kabel-TV nettet installeres en galvanisk isolator mellom utstyret og kabel-TV nettet.

Svensk

Utrustning som är kopplad till skyddsjord via jordat vägguttag och/eller via annan utrustning och samtidigt är kopplad till kabel-TV nät kan i vissa fall medföra risk för brand. För att undvika detta skall vid anslutning av utrustningen till kabel-TV nät galvanisk isolator finnas mellan utrustningen och kabel-TV nätet.

For Customers in Korea

KC

이 기기는 업무용(A급) 전자파적합기기로서 판매자 또는 사용자는 이 점을 주의하시기 바라며, 가정외의 지역에서 사용하는 것을 목적으로 합니다.

For Customers in Taiwan

BSMI

警告使用者：

此為甲類資訊技術設備，於居住環境中使用時，可能會造成射頻擾動，在此種情況下，使用者會被要求採取某些適當的對策。

For Customers in China

CCC

警告

此为A级产品，在生活环境中，该产品可能会造成无线电干扰。在这种情况下，可能需要用户对其干扰采取切实可行的措施。

注意

用错误型号电池更换会有爆炸危险

务必按照说明处置用完的电池

For Customers in Russia

TR-CU

Country of Origin	Made in China
Manufacturer	Buffalo Inc. Akamondori Bldg., 30-20, Ohsu 3-chome, Naka-ku, Nagoya 460-8315, Japan
For manufacturing date and country, refer to the product package. Дату изготовления и страну-производителя см. на упаковке. Өнімнің шығарылу мерзімі мен мемлекеті бойынша ақпаратты қаптамадан қараңыз. Дату и країну вырабу гл. на ўпакоўцы.	