

HOTGRIPS® PRO



NEW

ADVANCED HEATED GRIPS WITH INTEGRATED CONTROLLER

HOTGRIPS® PRO are the latest evolution of Oxford's vast range of world-leading heated grips. They offer fully integrated temperature control in 3 brand new, silicone formed grip patterns; improving durability and heat stability. Simply press the integrated button to set your temperature and allow them to self-regulate, while you keep your focus on the road.

Go to our dedicated website to find out more:

OXFORDHOTGRIPS.COM

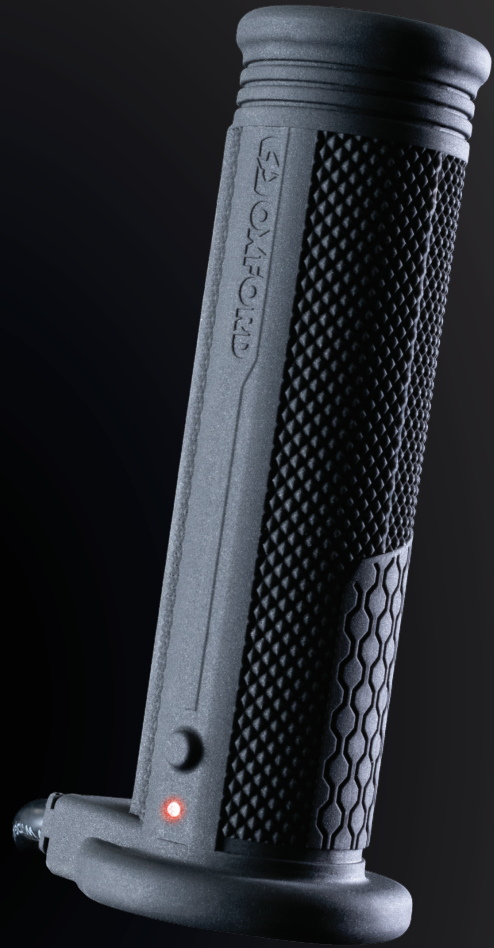

HEX

Creating a comfort layer, reducing vibration through the grip, whilst increasing durability.

KNURLING

Creates the largest surface area for maximum grip and control.

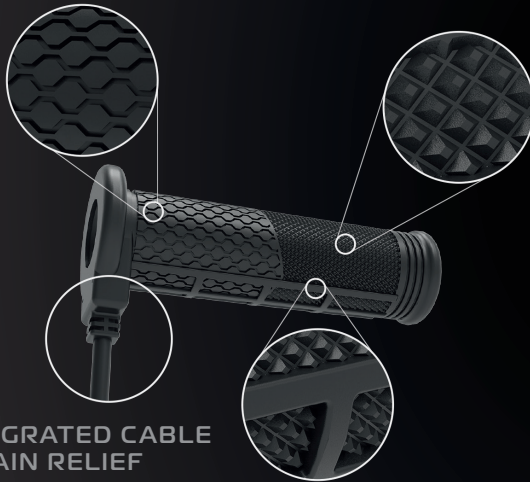

INTEGRATED CABLE STRAIN RELIEF

Allows for a more compact cable exit. This reduces the size of the grip without reducing the reliability and durability of the cable exit.

GRIPPER BARS

Designed for tough terrain where grip is more important for control and stability.



NEW

HOTGRIPS® PRO ADVENTURE



NEW

HOTGRIPS® PRO TOURING



NEW

HOTGRIPS® PRO SPORT



ZERO-G

PADDOCK STANDS



All of our paddock stands are engineered using the latest CAD technology and 3D modelling techniques. By being scientifically designed to minimise the required effort to move a given load, our new ZERO-G range of paddock stands literally take the weight off.

FRONT DOLLY STAND



REAR DOLLY STAND



MATERIAL:
Steel

MAX LOAD:
250kg

STAND WEIGHT:
5.8kg

LIFT HEIGHT:
350 - 360mm

FRONT STAND



REAR STAND



MATERIAL:
Steel

MAX LOAD:
300kg

STAND WEIGHT:
5.8kg

LIFT HEIGHT:
335mm

HEADSTOCK STAND



MATERIAL:
Steel

MAX LOAD:
250kg

STAND WEIGHT:
9kg

LIFT HEIGHT:
765mm max

SINGLE SIDED STAND



MATERIAL:
Steel

MAX LOAD:
300kg

STAND WEIGHT:
6.7kg

LIFT HEIGHT:
360mm
(Pin centre)



VIEW FULL RANGE AT
OXFORDZERO-G.COM

GARAGE SIGNS

FEATURES

- Made from high quality coated metal tin plate with rolled edges
- 4 x 3.2mm pre-drilled holes for attachment
- Dimensions: 30 x 20cm x 0.25mm thick
- Weight: 124g



LIVE TO RIDE



BEWARE



OXFORD



CHAIN CLEANER
500ml

BEST IN SHOW

CLEANING AND CARE PRODUCTS

A carefully formulated range of specialist cleaning and care products to make your pride and joy 'best in show'



BIKE DEGREASER
500ml



BRAKE CLEANER
500ml



FAST FINISH POLISH
500ml



**XXL SIZE CANS
50% MORE PRODUCT***

**VISIT THE
MICROSITE
HERE**



*Chain Cleaner & Bike Degreaser 750ml

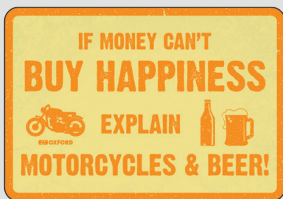

BUY HAPPINESS

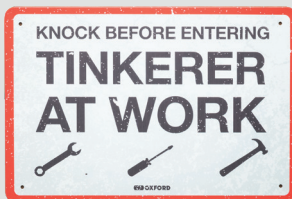

TINKERER



THERE IS A GOD



WOMAN CAVE

[VIEW MORE AT OXFORDPRODUCTS.COM](http://OXFORDPRODUCTS.COM)

EXHAUST SHIELDS

MOTORCYCLE ACCESSORIES

Oxford's Exhaust Heat Shield offers thermal protection by deflecting radiated exhaust heat and guards against you, your clothing or your accessories from accidentally touching a hot exhaust system. The Heat Shield is supplied with adjustable clamps so it can be fitted to a variety of different sized exhaust pipe diameters. Available in four bespoke designs to suit the style of your bike: Cafe, Street, Sport and Scrambler.

FEATURES

- Stainless steel construction
- Thermal protection
- Corrosion resistant
- Easy to install

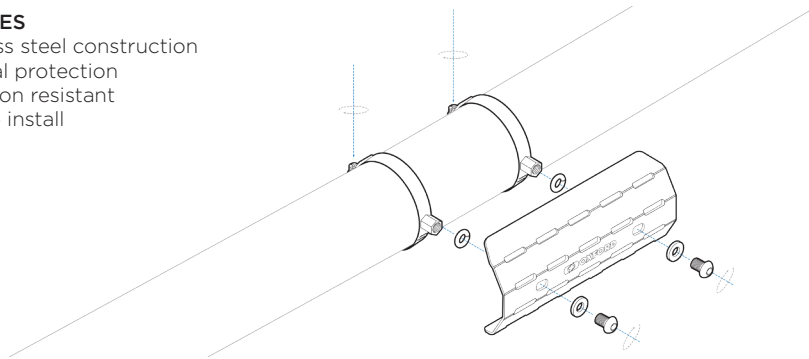

NEW CAFE

INCLUDES

- Includes: 45 - 60mm clamp(s), anti-vibration washers; M6 screws; flat washers

NEW STREET

INCLUDES

- Includes: 45 - 60mm clamp, anti-vibration washer; M6 screw; flat washer

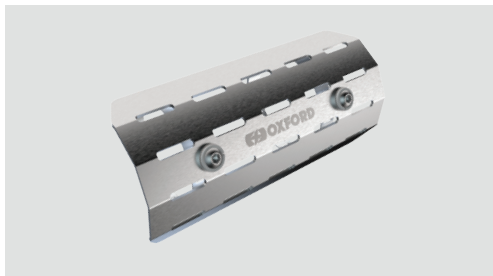

NEW SPORT

INCLUDES

- Includes: 45 - 60mm clamp(s), anti-vibration washers; M6 screws; flat washers

NEW SCRAMBLER

INCLUDES

- Includes: 45 - 60mm clamp(s), anti-vibration washers; M6 screws; flat washers

WORKSHOP MATS

FEATURES

- Sewn edge to hold back spills
- Hard wearing polyester
- 5mm deep pile carpet
- Size: 200 x 100cm
- Fluid resistant TPR backing
- Track compliant (meets FIM requirements)

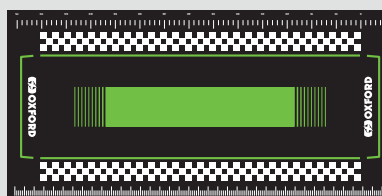

PITLANE GREEN



SPORT



NEW

SEQUENTIAL INDICATORS

The ultimate trick upgrade. The indicator dynamically sweeps across from the inside to the outside of the indicator strip, when activated. A universal fit makes these a must-have for any bike.

DarkChaser

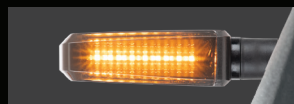

NightFighter

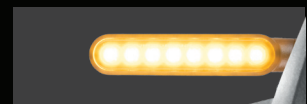

DarkSeeker

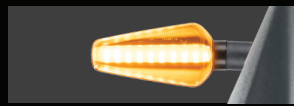

DarkHunter

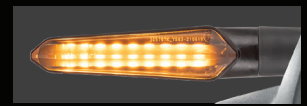

ADVENTURE



CAFE



VIEW MORE AT OXFORDPRODUCTS.COM

RIDER COMFORT

MOTORCYCLE ACCESSORIES

The new Air Seats and Cool Seats from Oxford are the perfect accessory for your next adventure.



"Adventure & Touring" and "Pillion & Enduro" Air Seats

NEW AIR SEATS

Air pocket seat cushion

FEATURES

- Improves riding comfort for all
- Eliminates numbness & painful pressure points
- Air mesh fabric controls moisture & heat
- Pump included with schrader valve fitment
- Air cushion: 100% TPU
- Cover: 100% polyester

NEW COOL SEATS

Mesh seat cushion

FEATURES

- Improves riding comfort for all
- Designed to keep air flowing between rider and seat
- Air mesh fabric controls moisture & heat
- Non-slip rubber backing
- Universal fit
- 100% polyester

STREET & SPORT



ADVENTURE & TOURING



PILLION & ENDURO



STREET & SPORT



ADVENTURE & TOURING



PILLION & ENDURO



CLIQR

A huge range of quick-release options to securely mount your mobile phone!

VIEW FULL RANGE AT OXFORDCLIQR.COM



NEW



USB TYPE C
HANDLEBAR MOUNT

NEW FILTER BUDS

Reusable noise filtering earplugs

When you're riding, you DON'T want to damage your hearing with the constant roar of the wind whipping under and over your helmet. You DO however want to hear the things which make for a safe and enjoyable ride... your engine note, vehicles around you, sirens, alarms and the sounds of other people going about their business. Regular earplugs just block out sound... ALL of it!

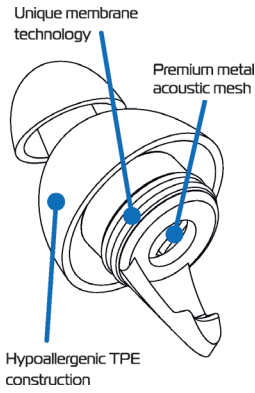

NEW SMART FINGERS

Touchscreen glove contacts compatible with smart phones & tablets

Have you got a favourite pair of gloves but can't operate your phone with them on? The solution is Oxford's Smart Fingers. Just affix these touchscreen compatible contact pads to the fingertips of your gloves and you'll never need to remove them to use your phone again.



NEW DESIGNS

RIGGERS

HEAVY DUTY MOTORCYCLE BRACES

Oxford Riggers are super strong and now available in a range of new designs.

- Anti-snap rubber teeth protect clothing
- Extra strong clips
- Adjustable size - 400-750 mm length
- 50mm or 35mm elastic
- Material: 80% Elastic, 15% Metal and 5% PU



CHIC



SLIM



NAVY



KHAKI



CLASSIC

VIEW MORE AT OXFORDPRODUCTS.COM

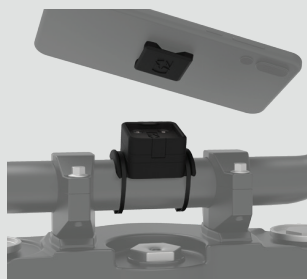

CABLE-TIE MOUNT

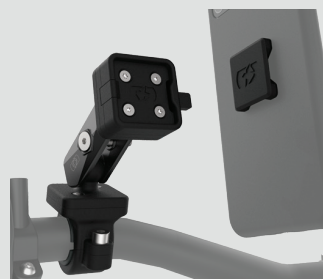

HANDLEBAR PIVOT MOUNT

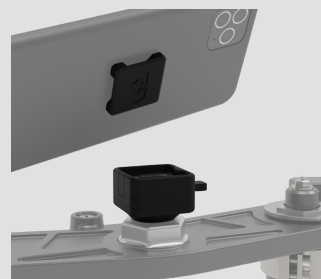

HEADSTOCK MOUNT



TRAVEL CAMPING ESSENTIALS

NEW FIRE PIT & GRILL

Top notch stainless steel firepit & grill which fold flat into a carry pouch.



NEW CAMPING CHAIR

Ultra compact fold-away seat



FUEL FLASK

Emergency fuel carrier

FEATURES

- Leakproof seal
- Lightweight aluminium
- Tough construction
- 1.5L: 320 x 88mm
- 1L: 270 x 80mm
- Use with Bottle Stash



BOTTLE STASH

Drinks and fuel bottle carrier

FEATURES

- 4 fixing straps
- Molle webbing mounting points
- Durable 600D polyester construction
- Max bottle size: 88mmø x 320mm



NEW ACCESSORIES

Great additions for any adventure!

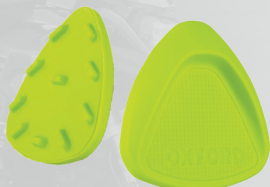

MAGNIMATE:
MAGNETIC STAND PUCK



FOLDING CUTLERY SET



CAMPING MUG