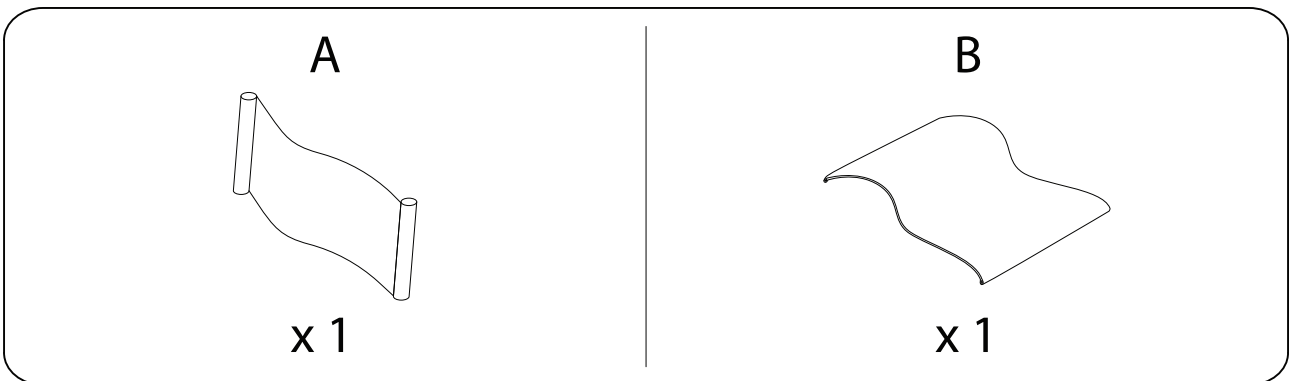
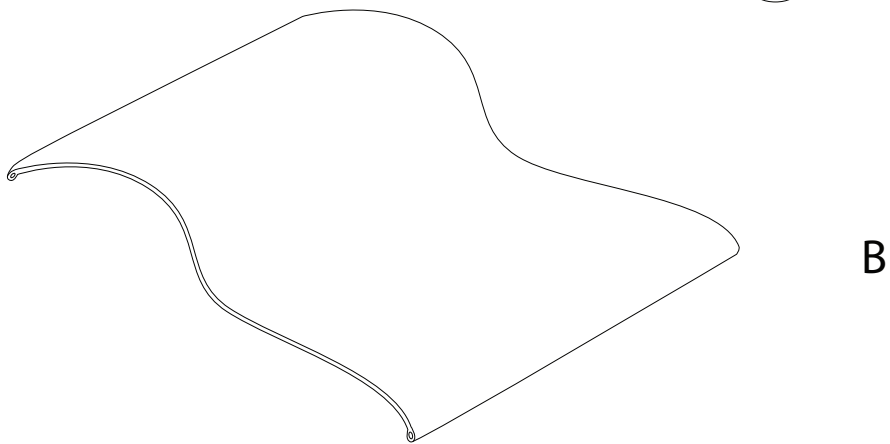
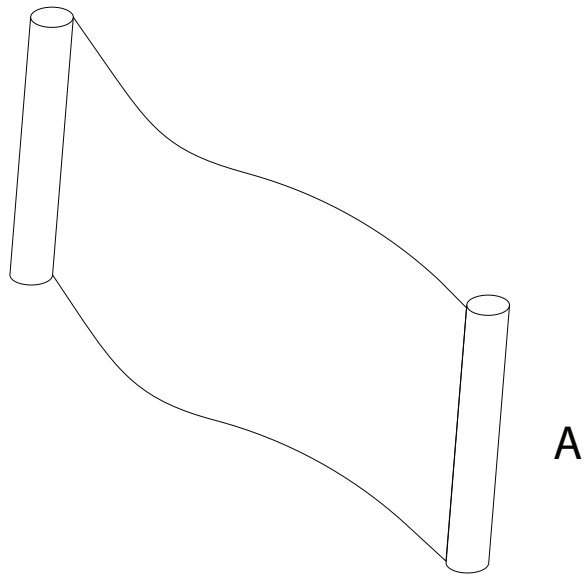

Diagram illustrating assembly instructions and safety warnings:

- Warning 1:** A crossed-out power drill icon indicates that a power drill should not be used for assembly. This warning is associated with a clock icon and the number **10'**, representing a 10-minute time limit.
- Warning 2:** A crossed-out warning triangle icon indicates a safety hazard. This warning is associated with a person icon and the number **1**, representing that one person should be present during assembly.

1/4



1

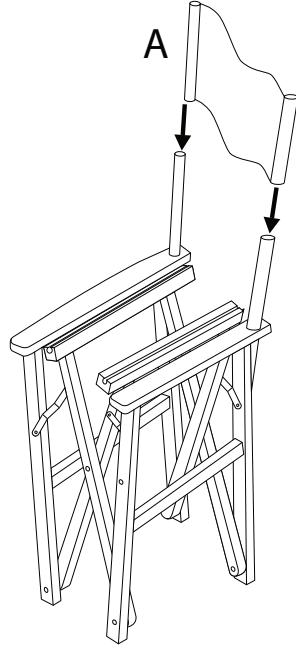
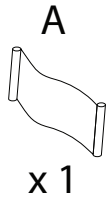

2

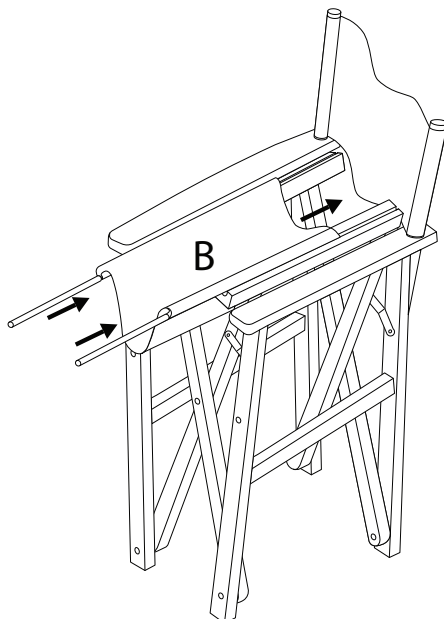
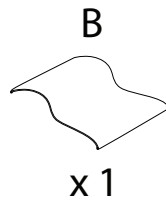

3

