

# AREBOS

## Patio Heater 2000W

AR-HE-HS2000CRS/B  
AR-HE-HS2000WRS/B



Please follow all security measures in this user's manual to ensure a secure use.



Thank you for trusting in AREBOS.

## Table of Contents

<b>1. Safety Instructions.....</b>	<b>3</b>
1.1 Explanation of the symbols .....	3
1.2 General safety instructions .....	3
1.3 Intended use.....	5
1.4 Improper use .....	5
<b>2. Heater Components .....</b>	<b>6</b>
<b>3. Technical Data .....</b>	<b>6</b>
<b>4. Assembly.....</b>	<b>7</b>
4.1 Wall mounted function .....	7
4.2 With heater holder function.....	8
<b>5. Operation of Remote Control.....</b>	<b>11</b>
<b>6. Maintenance and Cleaning.....</b>	<b>12</b>
6.1 Maintenance.....	12
6.2 Cleaning .....	12
<b>7. Disposal instruction .....</b>	<b>13</b>
7.1 Disposal of the packaging.....	13
7.2 Disposal of waste equipment.....	13
7.3 Meaning of the “dustbin” .....	13
<b>EU Declaration of Conformity .....</b>	<b>14</b>

Please read and save these instructions. Read through this user's manual carefully before using this product. Protect yourself and others by observing all safety information, warnings and cautions. Failure to comply with instructions could result in personal injury and/or damage to product or property. Please retain instructions for future reference.

## 1. Safety Instructions

### 1.1 Explanation of the symbols



This product **must not** be disposed of with household waste!



By means of a CE marking, it can be recognized that a product complies with the legal requirements of European legal standards and therefore may be traded within the European Community.



Warning of electrical voltage!



**Warning!** Hot surface!



**Warning!** Read the safety instructions carefully. Failure to follow the safety precautions could result in serious injury or damage. Keep the operating instructions in a safe place.

### 1.2 General safety instructions

- Keep all safety information and instructions for future reference.
- The appliance can be used by children aged from 8 years and above and persons with reduced physical, sensory or mental capabilities or lack of experience and / or knowledge if they have been given supervision or instruction concerning use of the appliance in a safe way and understand the hazards involved.
- Children must not play with the appliance. Cleaning and user maintenance must not be carried out

by children without supervision.

- Children younger than 3 years must be kept away unless they are supervised at all times.
- Children aged 3 years and under and under 8 years may only switch the appliance on and off if they are supervised or have been instructed in the safe use of the appliance and understand the resulting hazards, provided that the appliance is placed or installed in its normal position of use
- Children aged 3 years and under 8 years must not insert the plug into the socket, regulate the appliance, clean the appliance and/or carry out user maintenance.
- Do not use the appliance in small rooms if there are people in them who cannot leave the room independently and are not under constant supervision.
- Do not operate the unit in rooms where there is a risk of explosion.
- Do not operate the unit in aggressive atmospheres.
- Allow the unit to dry after wet cleaning. Do not operate the unit when it is wet.
- Do not operate or handle the unit with wet or damp hands.
- Do not expose the unit to direct water jets.
- Never insert objects or limbs into the unit.
- Do not cover or transport the unit during operation.
- Do not sit on the unit.
- The appliance is not a toy. Keep children and animals away. Only use the appliance under supervision.
- Before each use, check the appliance, its accessories and connecting parts for possible damage. Do not use defective devices or device parts.
- Make sure that all electrical cables outside the unit are protected from damage (e.g. by animals). Never use the unit if the electrical cables or the mains connection are damaged!
- The power connection must comply with the specifications in the chapter Technical Data.
- Insert the mains plug into a properly fused mains socket.
- Select mains cable extensions taking into account the appliance connection power, cable length and intended use. Unroll extension cords completely. Avoid electrical overload.
- Before servicing, maintaining or repairing the unit, unplug the mains cable from the mains socket by grasping the mains plug.
- Switch off the unit and unplug the power cord from the mains socket when you are not using the unit.
- Never use the unit if you notice any damage to the power plug or power cord. If the mains lead of this appliance becomes damaged, it must be replaced by the manufacturer or its after-sales service or a similarly qualified person in order to avoid hazards. Defective mains cables pose a serious health hazard!
- During installation, observe the minimum distances to walls and objects as well as the storage and operating conditions according to chapter Technical data.
- Do not use the unit in the immediate vicinity of curtains.
- Do not transport the unit during operation.
- Let the unit cool down before transport and / or maintenance work.
- Do not use this unit near bathtubs, shower trays, swimming pools or other vessels containing water. There is a risk of electric shock!
- The unit must not be placed directly below a wall socket.
- The appliance must be installed in such a way that switches and other controls cannot be touched by a person in the bath or shower.
- The appliance must not be used with a programme switch, a timer, a separate remote control system or a similar device that switches the appliance on automatically, as there is a risk of fire if the heater is covered or incorrectly positioned.

### **1.3 Intended use**

- Use the appliance to heat surfaces in covered and uncovered outdoor areas.
- The appliance is designed for domestic use and is not suitable for commercial use.
- The appliance is intended for floor installation only.
- The intended use includes the heating of surfaces:
  - In storage rooms,
  - In construction site rooms,
  - In containers,
  - In the catering trade,
  - At trade fairs and events,
  - In covered outdoor areas (e.g., covered terrace).

### **1.4 Improper use**

- The unit is not intended for industrial use.
- Do not place the appliance on a wet or flooded surface.
- Do not place any objects, such as items of clothing, on the unit.
- Do not use the appliance for heating vehicles.
- Do not use the appliance near petrol, solvents, varnishes or other highly flammable vapours, or in rooms where they are stored.
- The appliance must not be used as a heater for babies/ children or animals.
- The appliance must not be installed in a shower cubicle or directly above a bathtub.
- The appliance must not be used near swimming pools.
- Do not use the unit in the immediate vicinity of washbasins, bathtubs or other containers that contain water. Never immerse the unit in water.
- Any operation or use other than that specified in these instructions is not permitted. Failure to comply will invalidate any liability and warranty claims.
- Unauthorised structural changes, additions or conversions to the unit are prohibited.

## 2. Heater Components

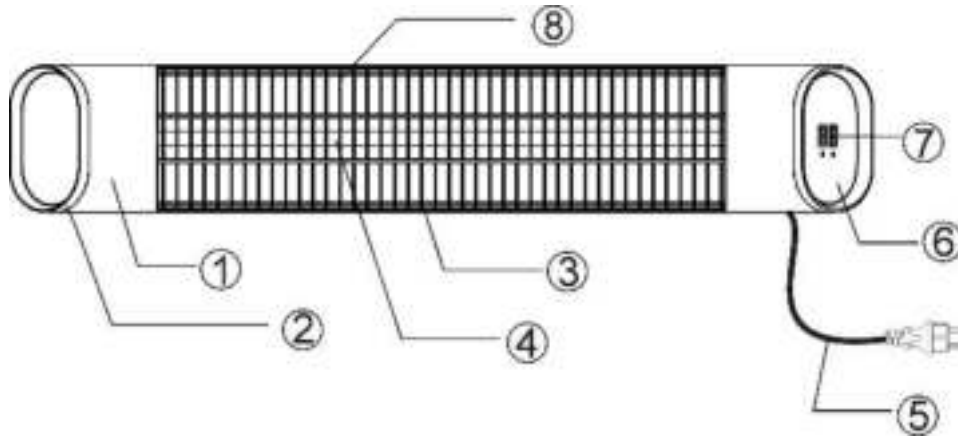

1	Aluminium box
2	Plastic cover
3	Aluminium fuselage
4	Heating tube
5	Power cord
6	Right housing
7	LED displayer
8	Protection grille

## 3. Technical Data

Model	AR-HE-HS2000WRS AR-HE-HS2000WRB	AR-HE-HS2000CRS AR-HE-HS2000CRB
Voltage	AC 220V-240V	AC 220V-240V
Frequency	50Hz/60Hz	50Hz/60Hz
Power(W)	2000W	2000W
Protection class	I	I
Degree of protection	IP65	IP65
Remote control battery type	CR 2032 / 3V	CR 2032 / 3V
Height telescopic pole	NA	110-180cm
Dimension of product (mm)	852 x 105 x 130mm	852 x 650 x (1150-1850) mm
Weight	2.7 kg	5.4 kg

## 4. Assembly

### 4.1 Wall mounted function

1. There are 4 brackets and fasteners used with the heater. Furthermore, in the canal of back side of the heater there are 4 square fastener washers 25×25mm. Take the square washers and fasten 2 brackets to the canal of the backside of the heater by the help of screws (Figure 1).

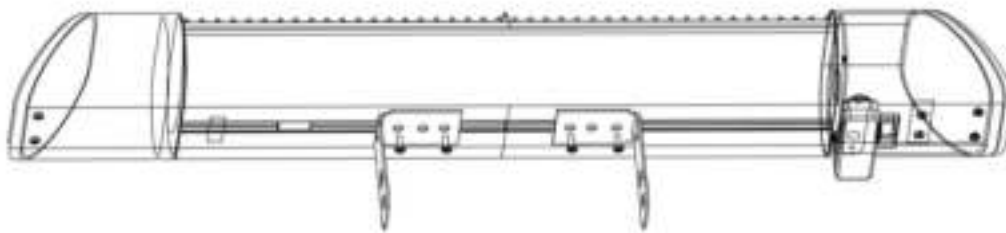

2. Fasten the brackets at the appropriate distance of each other (45-55cm) (Figure 2) .



3. Two other brackets are fastened by the help of fasteners at the appropriate distance on the wall parallel to the floor (at least 1.8 m from the floor and at least 0.75 m from the ceiling). (Figure 3).



4. Join the brackets on the heater with the brackets, fastened on the wall, with the help of figured screw-nuts (Figure 4). Install the heater under necessary angle (in the direction to the area being heated).

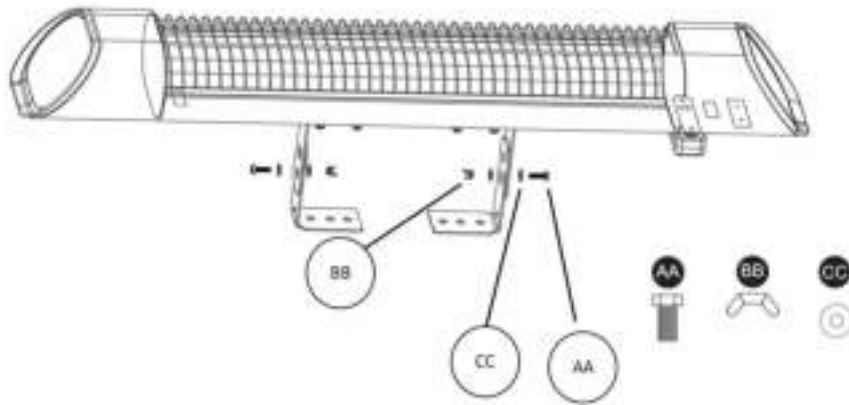

#### 4.2 With heater holder function

**Note:**

The heater holder is within delivery content of Model AR-HE-HS2000CRS and AR-HE-HS2000CRB.

**Heater holder structure**

1.	Base
1.1	Foot (4x)
1.2	Base center
1.3	Base center cover
2.	Bottom tube
3.	Fixed screw
4.	Top tube
5.	Fixed axle sleeve (2x)
6.	Fixed spacer (2x)
7.	Located button (2x)
8.	Fixed axle

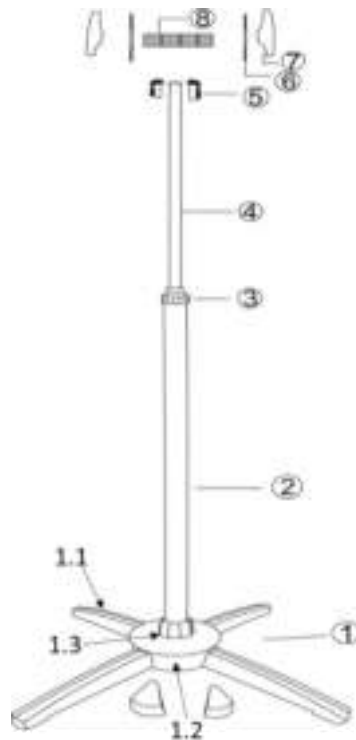



**Connect the heater body with the holder:**

1. Place 4x feet (1.1) into the slots on the bottom of the base (1.3) of the pole (2).

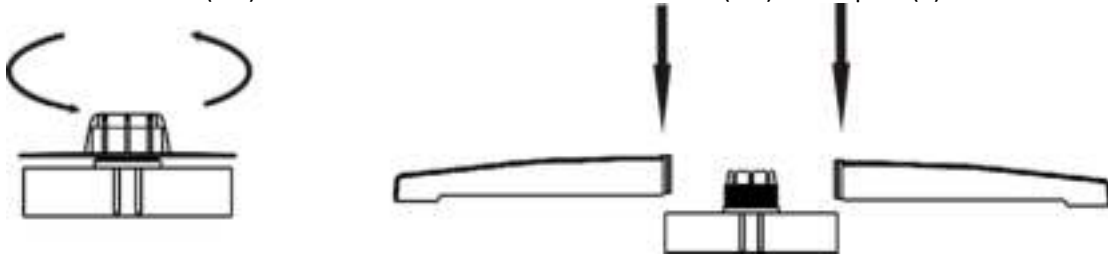

2. Tighten pole (2) into the stand center (1.2) by turning the pre-attached stand center cover clockwise until tight.

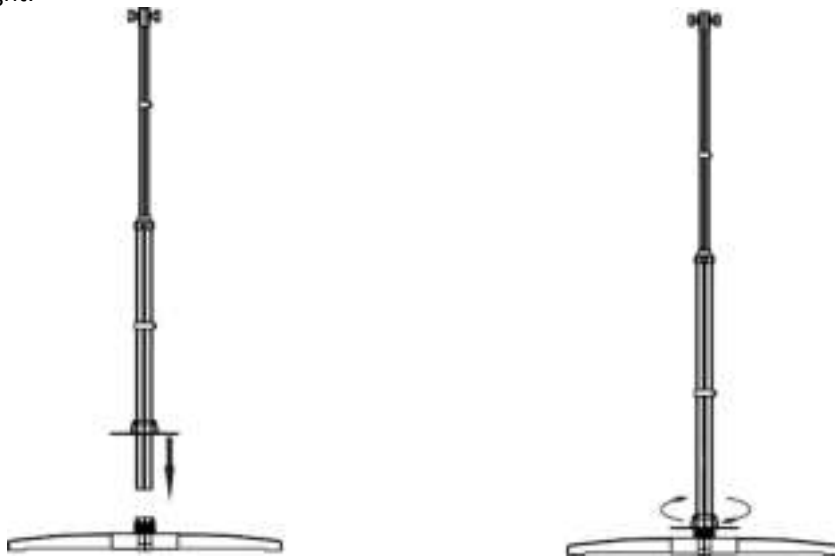

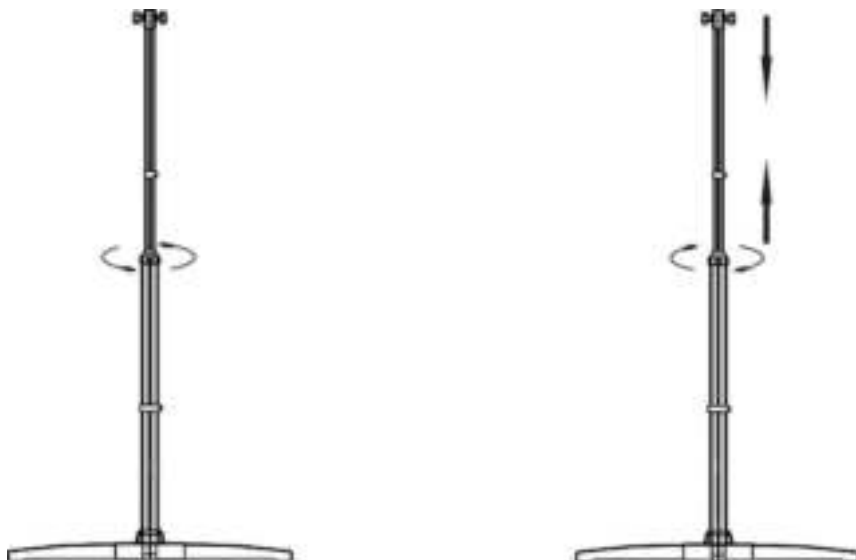

3. Adjust the height of stand as desired.

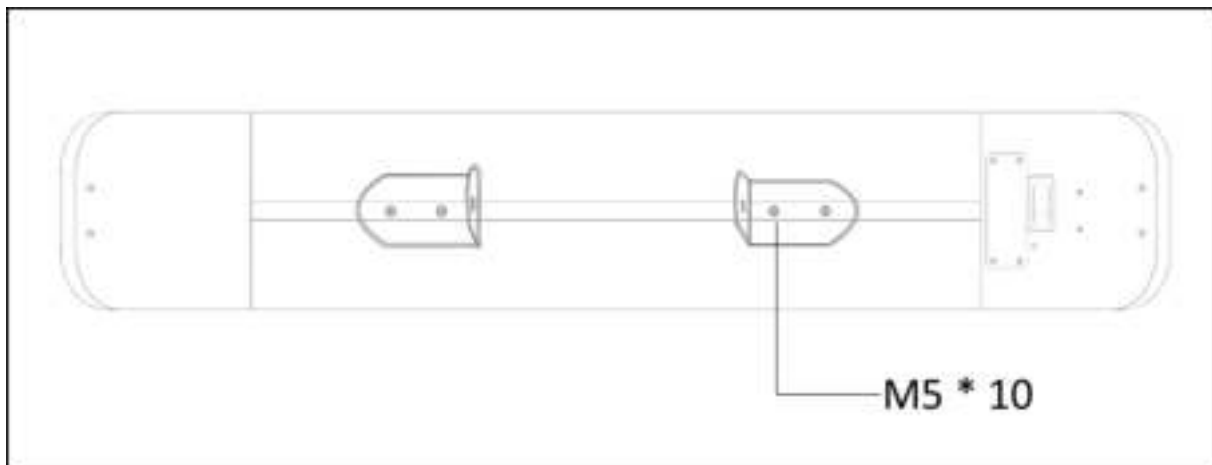
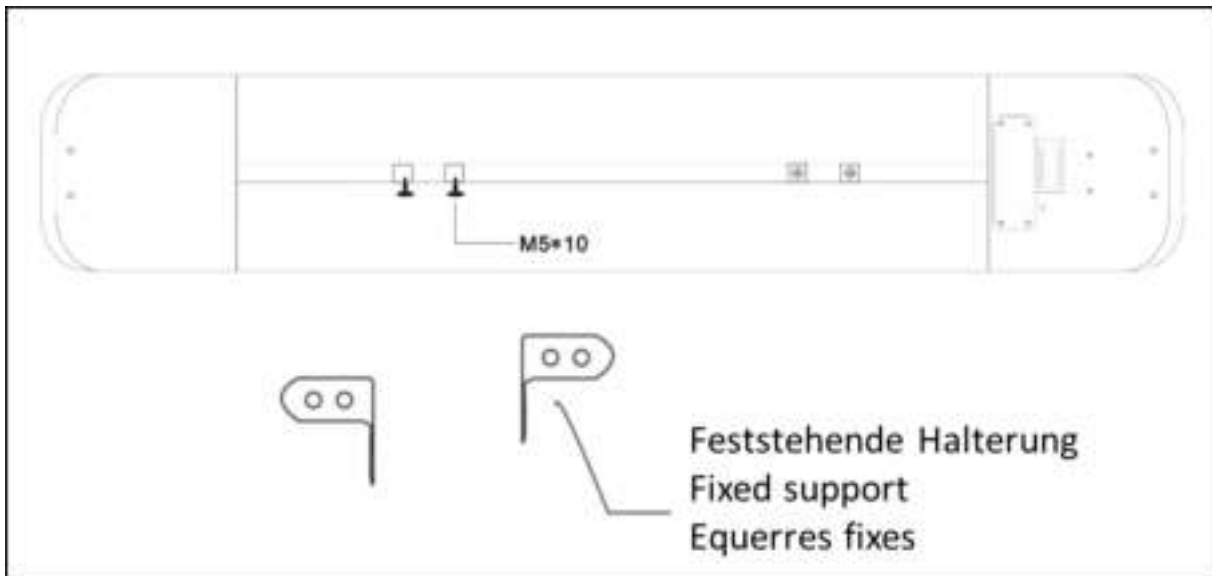

4. Place the heater head facing down on a soft surface.

5. Use M5x10 (4x) screws attach the fixed support (2x) to the back panel of device.



6. Loosen the Fixing knobs “” (2X) of the holder, then assemble the device and the holder as shown following.

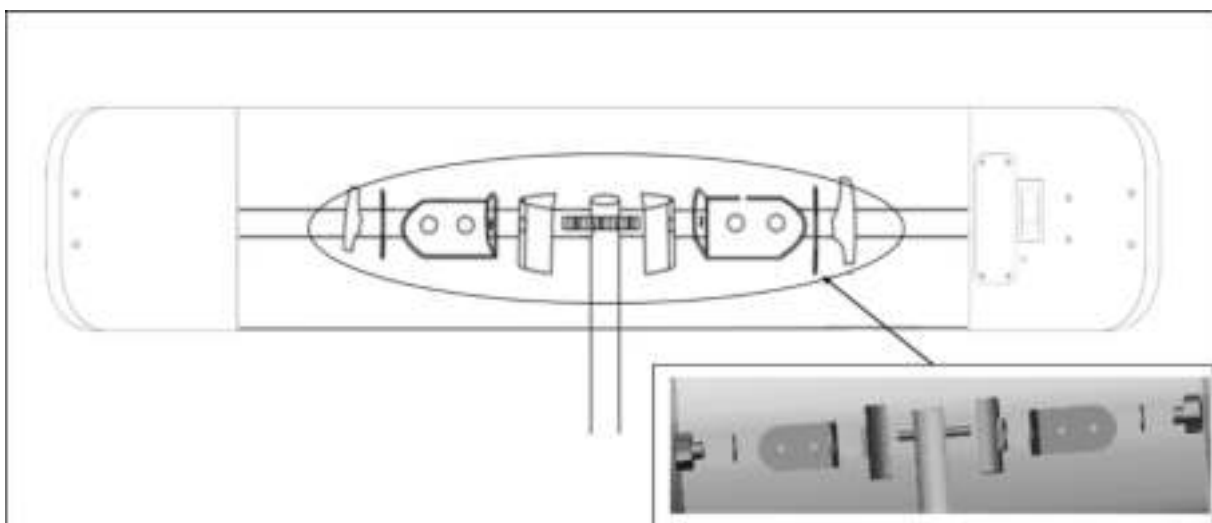

7. Now the device is attached with the holder. The heater is now ready to use. Ensure you have read these instructions thoroughly prior to use.

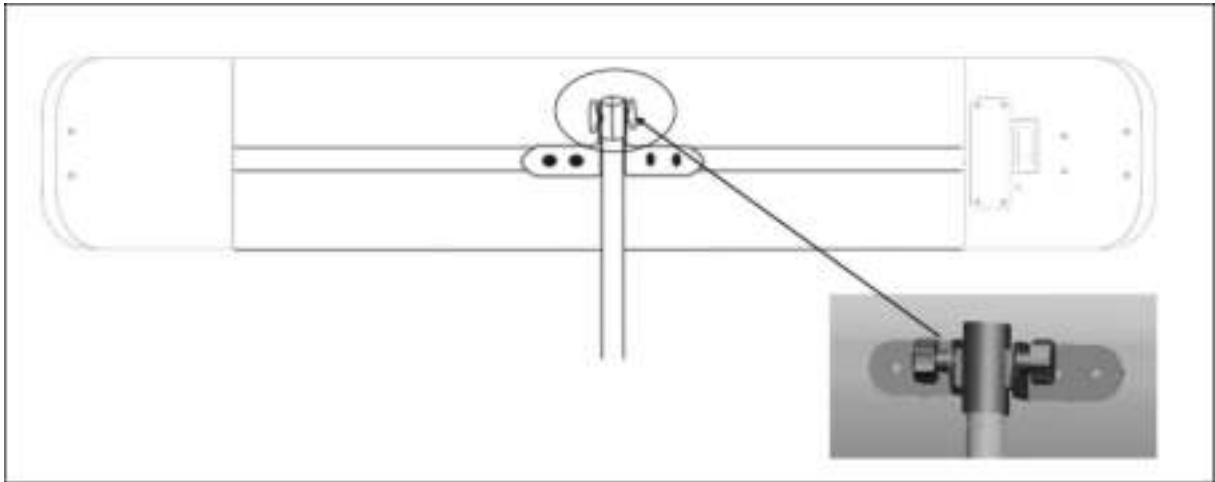







## 5. Operation of Remote Control

- The functions of the heater may be controlled via the buttons on your remote control and LED screen. You may also control some of the functions of your heater through the buttons on the front side of the heater.



1. Plug in and use the power switch in the rear right side to connect the power.



2. Press  in the remote to make the heater standby.
3. Press  to increase the power until F9.
4. Press  to decrease the power until F1.
5. Press , the heater is in half of full power.
6. Press , the heater is in full power.
7. Press  to set 24 hours power off.

## 6. Maintenance and Cleaning

### 6.1 Maintenance

- **Attention!** Careful and regular maintenance of infrared Heater is required to attain a long and efficient operation of your appliance.
1. Check the cleanliness of the reflector and IR-filament at least once a month. If necessary, apply cleaning and maintenance instructions.
  2. The number of checks may be increased considering the amount of the dust in the environment.
  3. Check the deformation of the reflector, wire and frame visually while cleaning the appliance. In case of any deformation, consult a qualified technician.
  4. Check the power cable and plug visually while cleaning the appliance. In case of any deformation, consult a qualified technician.
  5. It is recommended to change the reflector every 2 years for more efficient operation.

### 6.2 Cleaning

- **Attention!** Regular and careful cleaning helps your heater operate for longer years and more efficiently.
1. Unplug your power cable for your safety before cleaning your appliance.
  2. Take out the front grid wire through the inlets on the frame using a slotted screwdriver.
  3. Make sure that the power is off for your safety. Power cable plug must be unplugged.
  4. The reflector and filament must be cleaned with a soft cloth, a smooth brush or cool or dry air. The cloth may be damp but never too wet and the cleaner should not include any chemical.
  5. Refrain from using cleaning material likely to damage the reflector (cleanser etc.).
  6. Insert the wire grid using a slotted screwdriver.

## 7. Disposal instruction

### 7.1 Disposal of the packaging

- Please make reference to the guidelines and standards for appropriate disposal of the packaging valid in your region. In part, the package may consist of plastic bags - watch this respect, with special care to ensure that this is not out of the reach of children. There is a risk of suffocation!

### 7.2 Disposal of waste equipment

- Equipment must be disposed of in accordance with the rules and regulations of the local waste disposal.
- At the end of the long life of your article, please dispose of the valuable raw materials for proper disposal so that proper recycling can take place. If you are not sure how to proceed, the local waste disposal companies or recycling centers are happy to help.

### 7.3 Meaning of the “dustbin”



The symbol of the crossed-out dustbin on batteries or accumulators indicates that they must not be disposed of with household waste at the end of their service life. If batteries or accumulators contain mercury (Hg), cadmium (Cd) or lead (Pb), you will find the respective chemical symbol below the symbol of the crossed-out trash can. You are legally obliged to return old batteries and accumulators after use. You can do this free of charge in a retail store or at another collection point near you. Addresses of suitable collection points can be obtained from your city or local government.

Batteries may contain substances that are harmful to the environment and human health. Special care must be taken when handling batteries containing lithium due to the particular risks involved. The separate collection and recycling of old batteries and accumulators is intended to avoid negative effects on the environment and human health.

Please avoid the generation of waste from old batteries as much as possible, e.g. by preferring batteries with a longer life or rechargeable batteries. Please avoid littering public spaces by not carelessly leaving batteries or electrical and electronic equipment containing batteries. Please consider ways to reuse a battery instead of disposing of it, for example by reconditioning or repairing the battery.

You can also find more information on the Battery Act on the Internet at [www.batteriegesetz.de](http://www.batteriegesetz.de).

You can also visit our website at [www.arebos.de](http://www.arebos.de) to find out about other return options we have created.

**Our customer service number: +49 (0) 931-45232700**

## EU Declaration of Conformity

We,

Canbolat Vertriebs GmbH, Gneisenaustraße 10-11, 97074 Würzburg, Germany,

Hereby declare that the product named below, seen its design and construction as well as according to our sales, has been complied with the relevant and basic health and safety EU-requirements.

Name of the product:

Art. Nr.: 4260627427642; 4260627427239; 4260627427253; 4260627427659

Model Nr.: AR-HE-HS2000CRS/B; AR-HE-HS2000WRS/B

If the product has any modification not allowed by us, this declaration loses its validity.

Tested acc. to:

EMC directive 2014/30/EU

EN 55014-1:2017, EN61000-3-2:2014

EN 61000-3-3:2013, EN 55014-2:2015

Low Voltage Directive 2014/35/EU

EN 60335-2-30:2009 + A11:2012

EN 60335-1:2012 + A11:2014 + A13:2017

EN 62233:2008

ROHS 2011/65/EU ; (EU) 2015/863

Date/Manufacturer Signature/Location:

Würzburg, May 12, 2021



Identification of the signatory:

Korhan Canbolat, head of the company

Authorised representative for the technical documentation:

Korhan Canbolat

**Office address:**

Canbolat Vertriebs GmbH

Gneisenaustraße 10-11

D-97074 Würzburg

Return address can be found in the imprint: <https://www.arebos.de/impressum/>

VAT identification number: DE 263752326

Court of the Commercial Register is Würzburg, HRB 10082

WEEE Reg.-No. DE 61617071