



# BOTANICALS™

10349







Q LEGO® Builder



[LEGO.com/sustainable-packaging](https://LEGO.com/sustainable-packaging)



 <sup>FR</sup> **DONNEZ**  
OU  
**RECYCLEZ**

 OU  OU 

ASSOCIATION    MAGASIN    DÉCHÈTERIE

Adresses sur [quefairedemesdechets.fr](https://quefairedemesdechets.fr)



# BUILDER



Apple and the Apple logo are trademarks of Apple Inc., registered in the U.S. and other countries and regions. App Store is a service mark of Apple Inc. Google Play and the Google Play logo are trademarks of Google LLC. Tencent and the Tencent logo are trademarks of Tencent Inc.

Q [LEGO.com/devicecheck](https://www.lego.com/devicecheck)

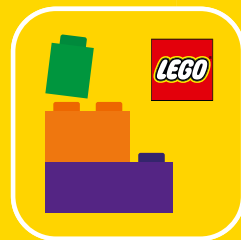

Q LEGO® Builder

EN Ask parents' permission before going online | DE Eltern um Erlaubnis bitten, bevor du online gehst | FR Demande l'autorisation d'un parent avant d'aller en ligne | IT Chiedi il permesso ai tuoi genitori prima di andare online | ES Pídeles permiso a tus papás antes de conectarte a Internet | PT Peça autorização aos pais antes de acederes online | ZH 上网前应先征得父母的同意 | PL Poproś rodziców o zgodę, zanim wejdiesz do Internetu | CS Než půjdeš na internet, požádej rodiče o svolení | SK Skôr než pôjdeš na internet, vypýtaj si povolenie od rodičov | HU Kérj szülői engedélyt, mielőtt online csatlakoznál! | UA Запитуйте дозволу батьків, перш ніж користуватися інтернетом | RO Cere permisiunea părinților înainte de a te conecta online | BG Поискайте разрешение от родител, преди да влезете онлайн | LV Pirms došanās tiešsaistē palūdz atļauju vecākiem | ET Enne Interneti kasutamist küsi vanematelt luba | LT Prieš prisijungdami prie interneto, atsiklauskite tėvų



# Dracaena

The Dracaena is also known as the **dragon tree**. Unlike actual dragons, it does not spew fire. It simply creates a fierce vibe. This LEGO® version enjoys exploring new spaces and is guaranteed to feel at home with you. (Especially if you let it hold hands with your **friendship plant**.)



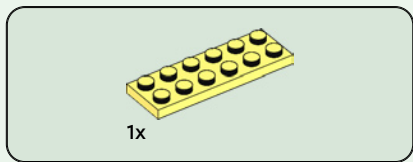
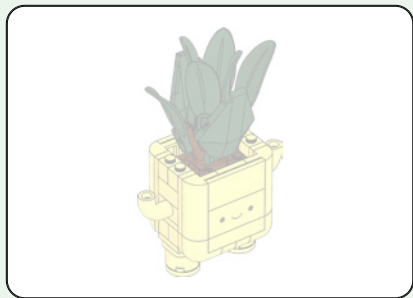

1

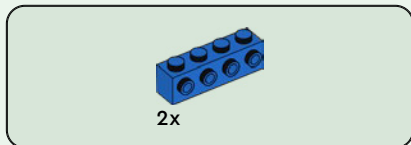
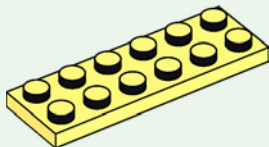

2

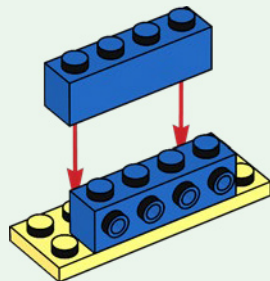

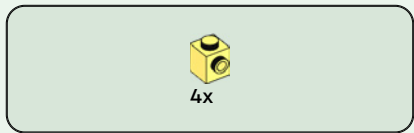

3

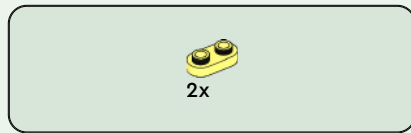
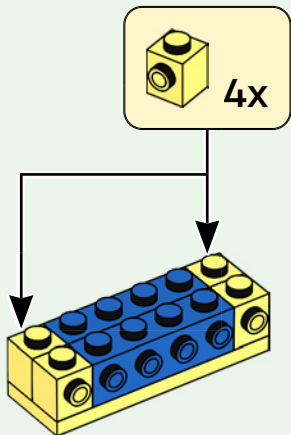

4

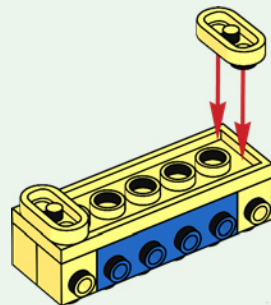



2x

5

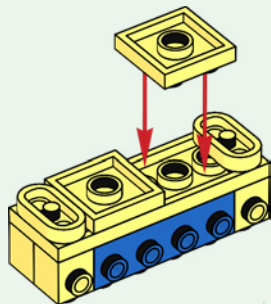

2x

6

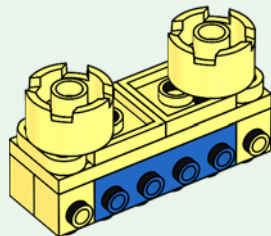



2x

7

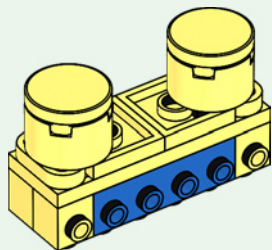

2x

8

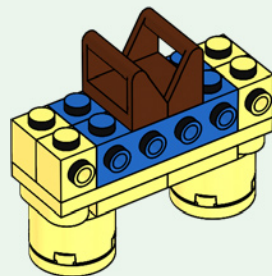

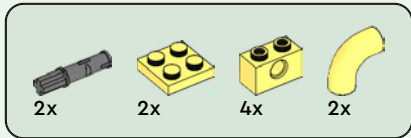

9

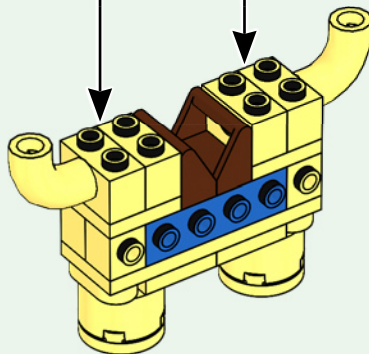
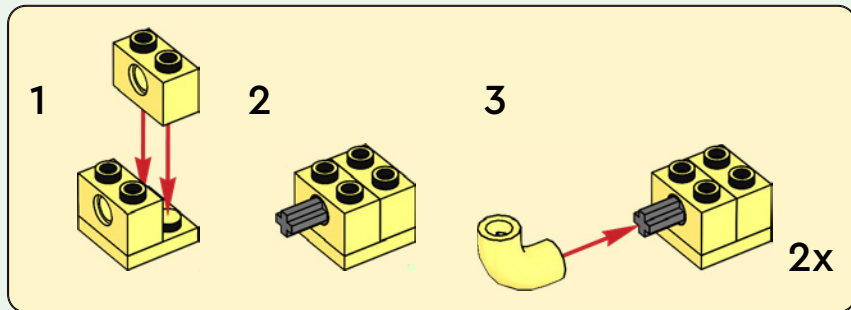

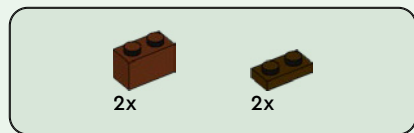

10

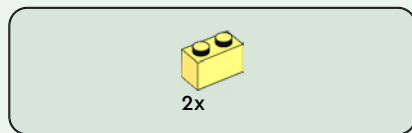
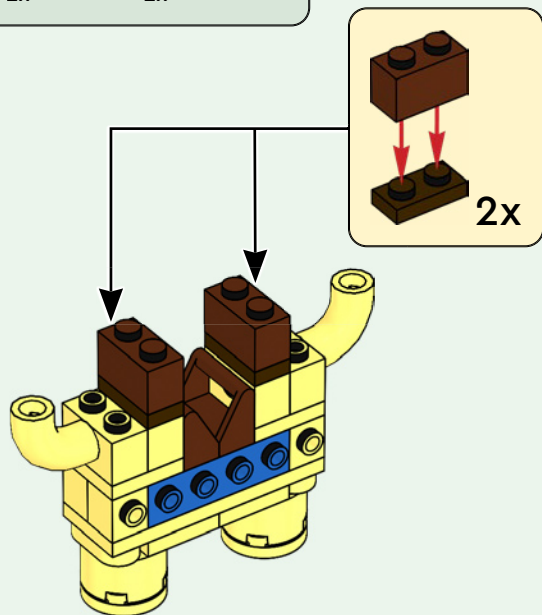

11

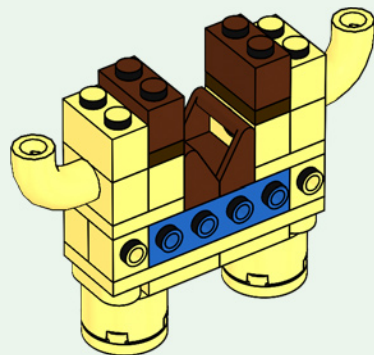



4x

12



4x

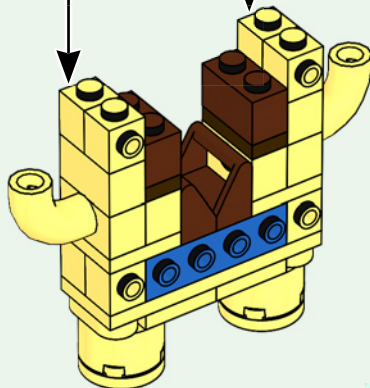



13

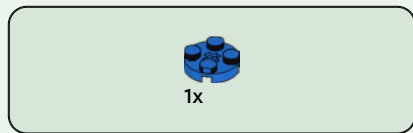
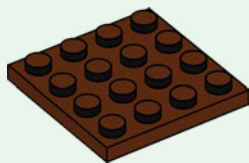

14

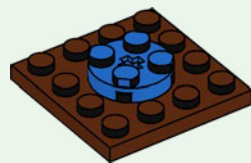



2x

15

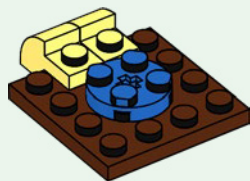

2x

16

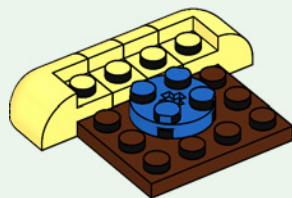

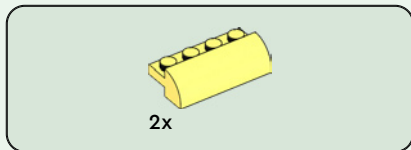

17

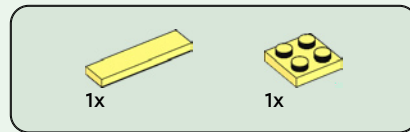
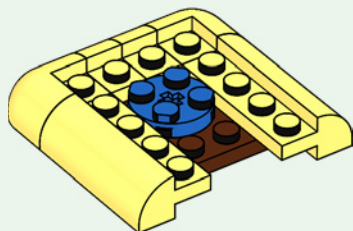

18

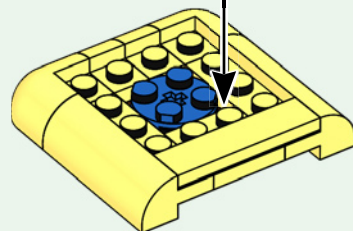
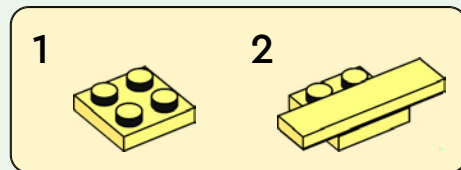

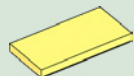

2x

19

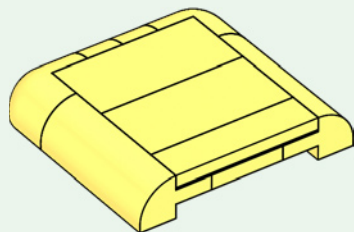

1x



2x

20

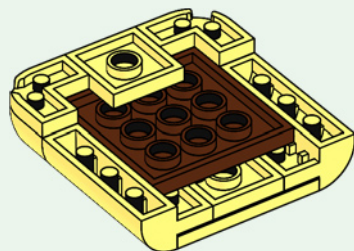



2x

21

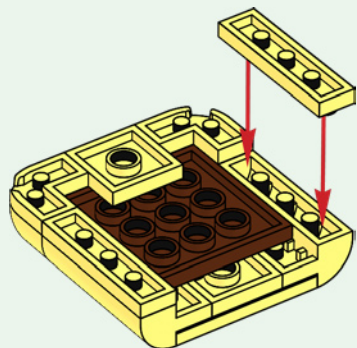

2x

22

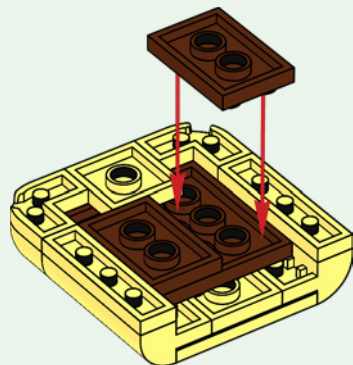

23

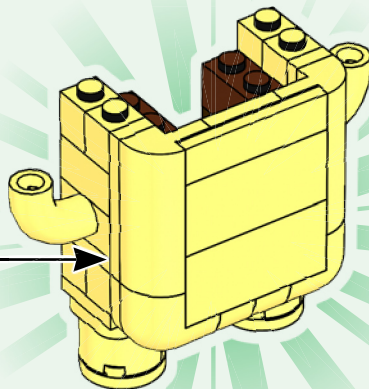



24

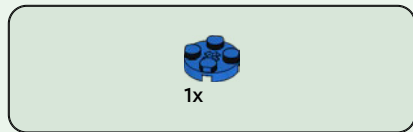

25

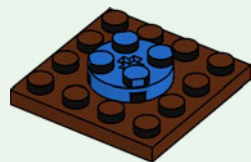



2x

26

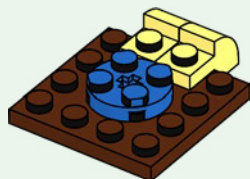

2x

27

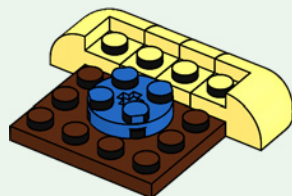

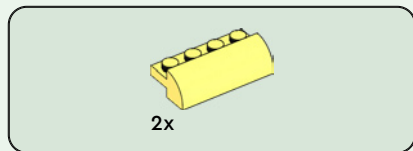

28

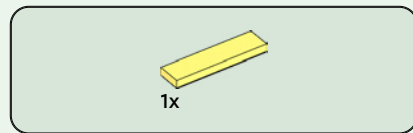
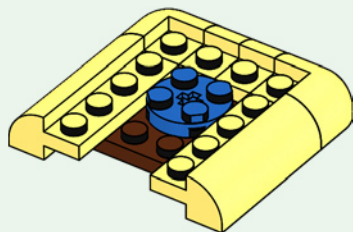

29

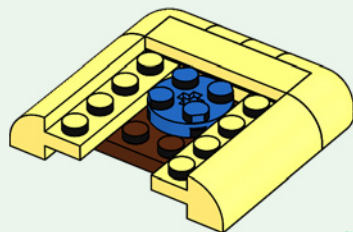

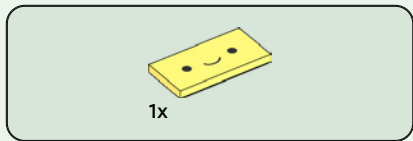

30

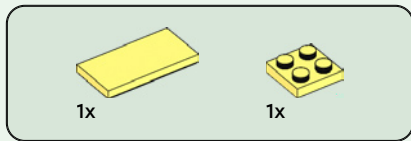
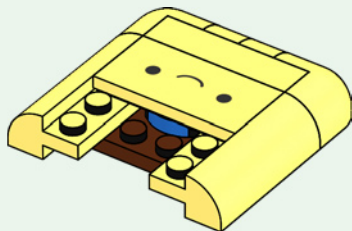

31

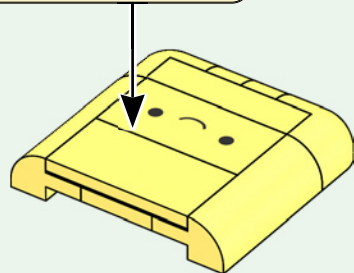
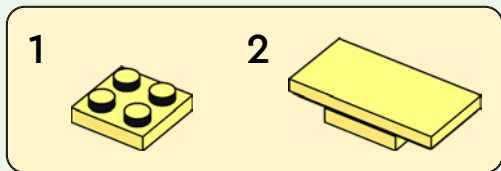



1x



2x

# 32

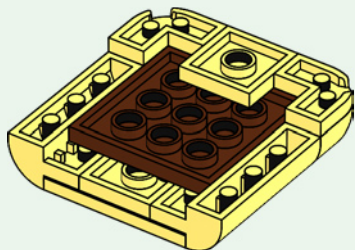
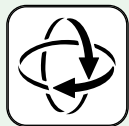

2x

# 33

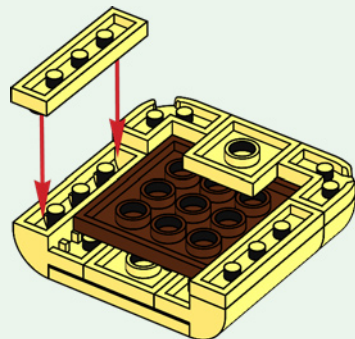



2x

34

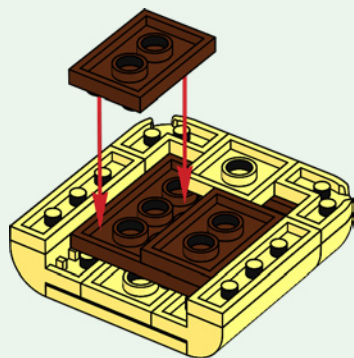

35

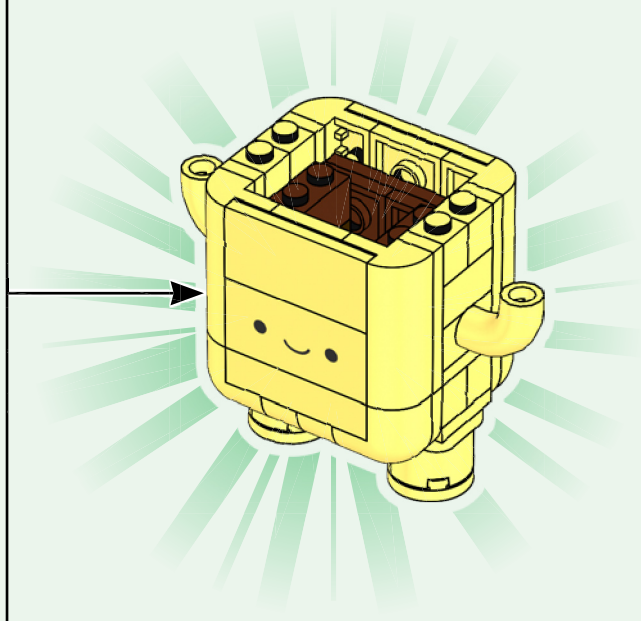

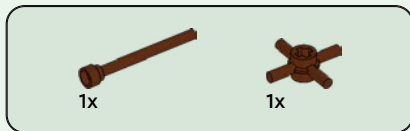
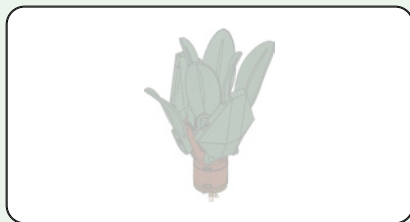

36

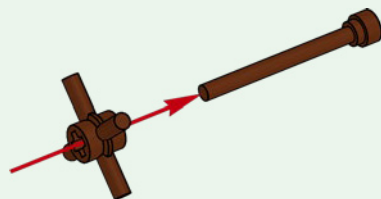

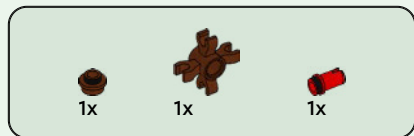

37

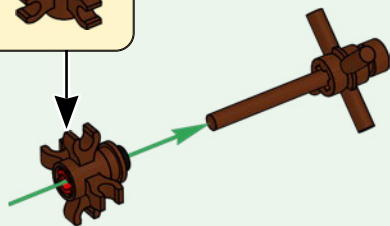
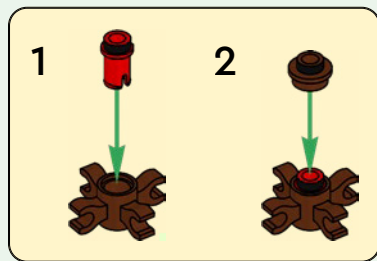



38

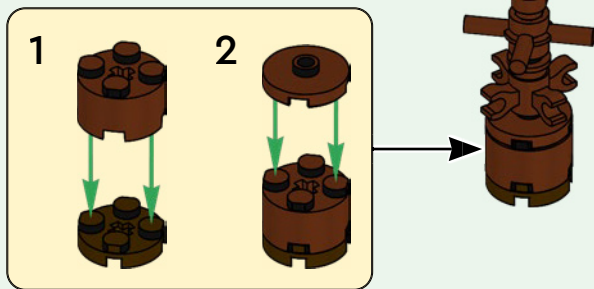

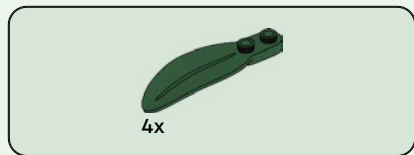

39

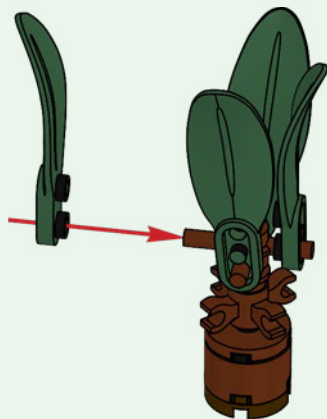

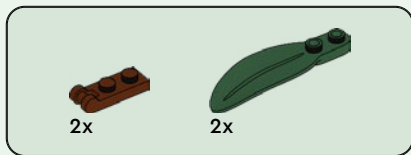

40

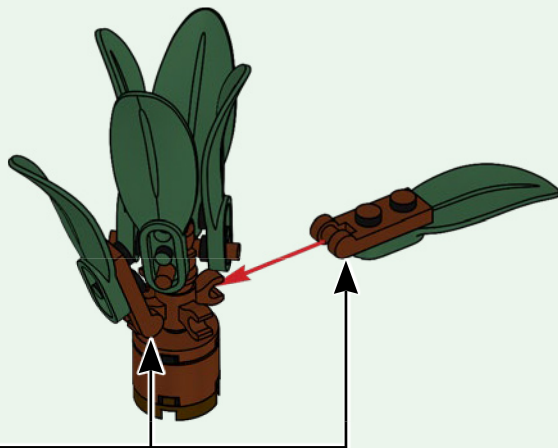
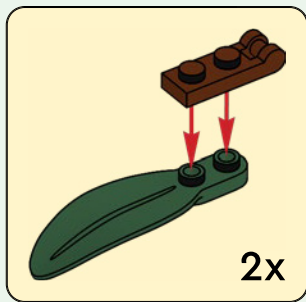



2x

41

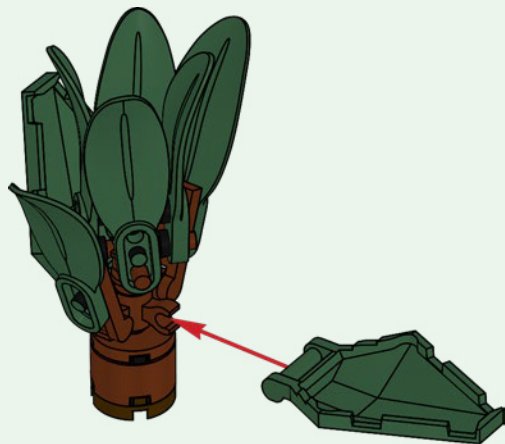

1x



1x

42

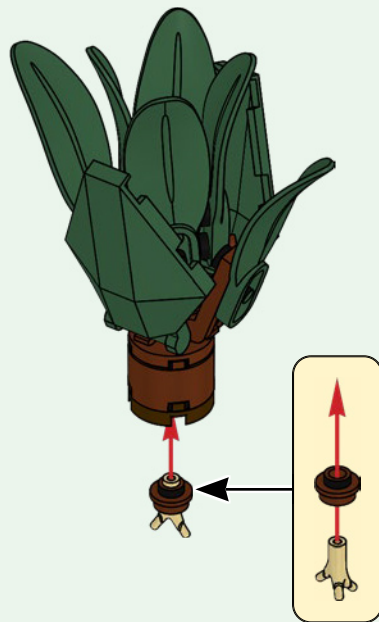

43

