





















1  1PC	2  1PC	3  1PC	4  1PC	5  1PC
6  1PC	7  1PC	8  2PCS	9  2PCS	10  1PC
11  2PCS	12  2PCS	13  2PCS	14  1PC	
A M6×15mm  26PCS	B M4×12mm  24PCS	C 4mm  1PC		

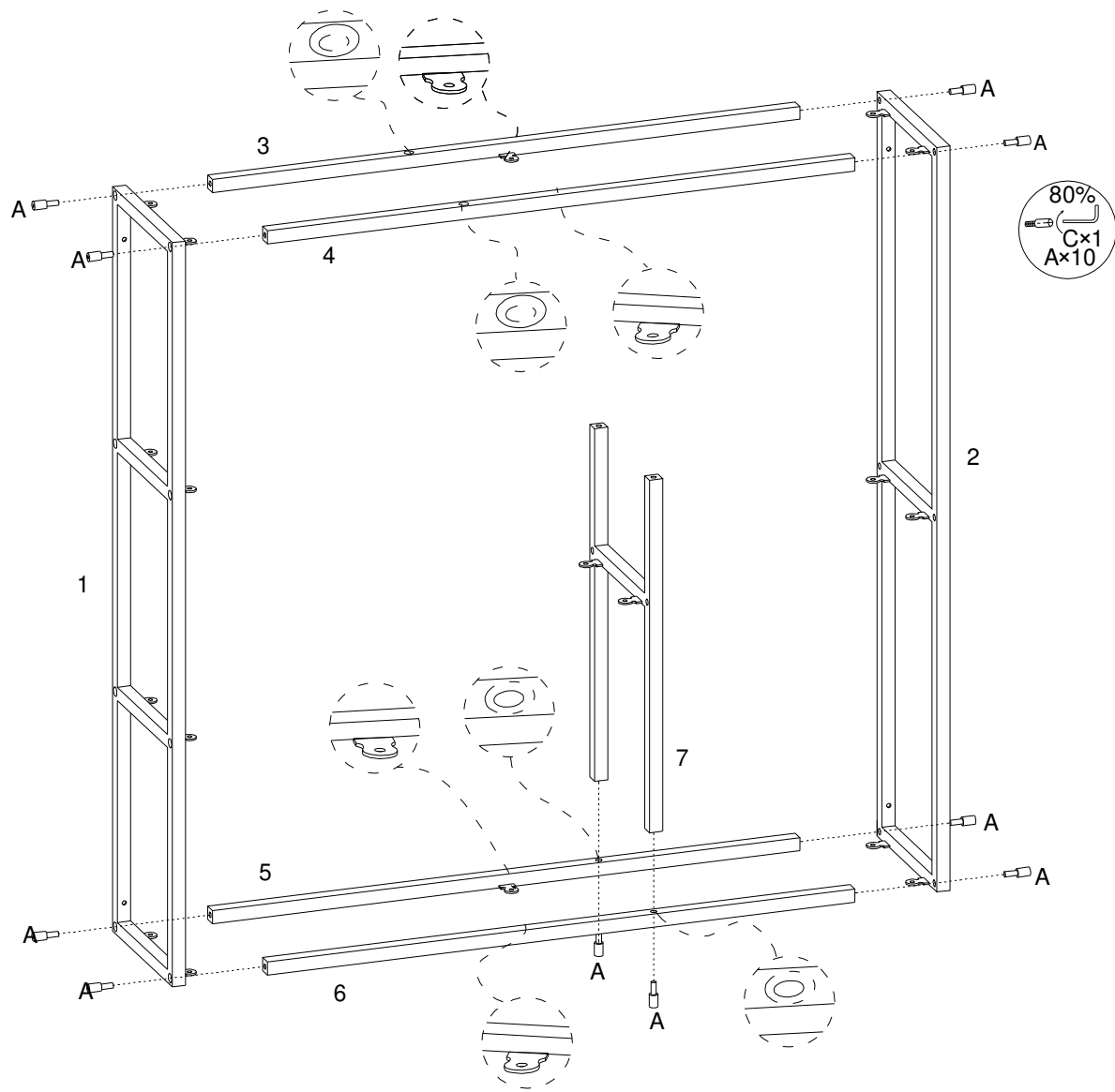

<p>A M6×15mm  10PCS</p>	<p>C 4mm  1PC</p>
---	---

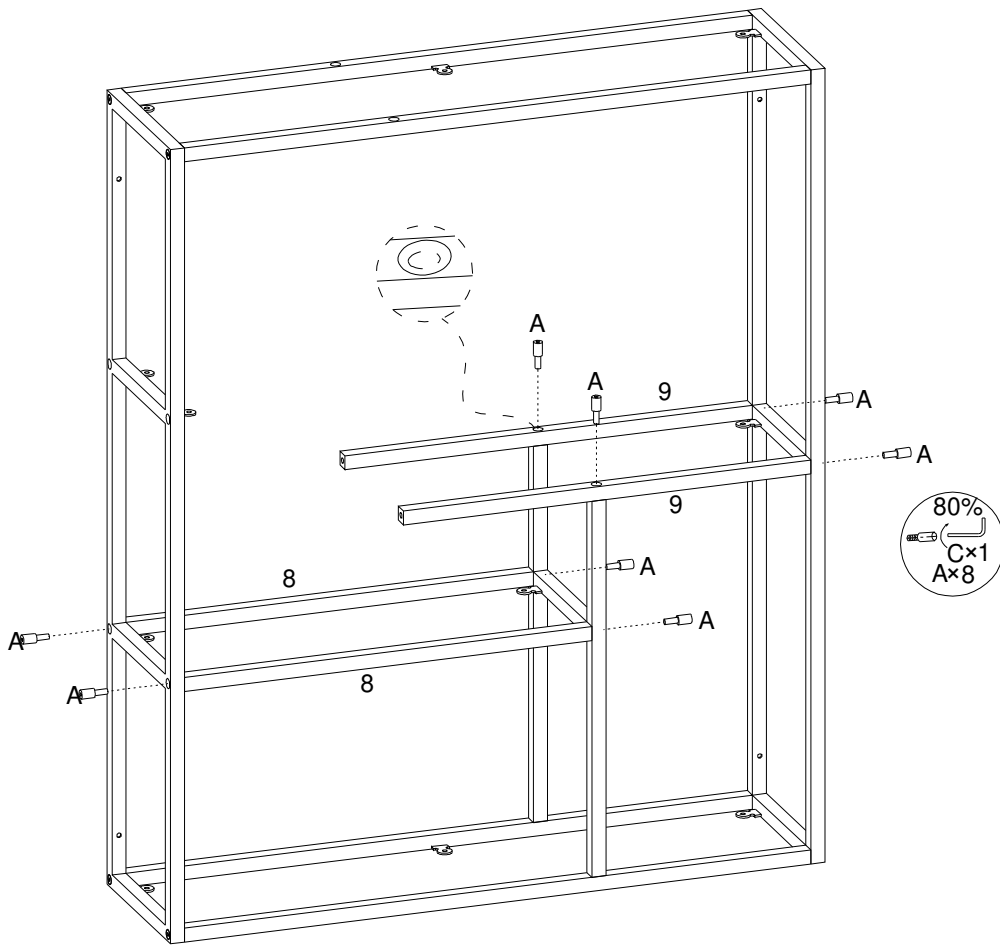

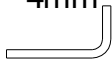
<p>A M6×15mm  8PCS</p>	<p>C 4mm  1PC</p>
--	---

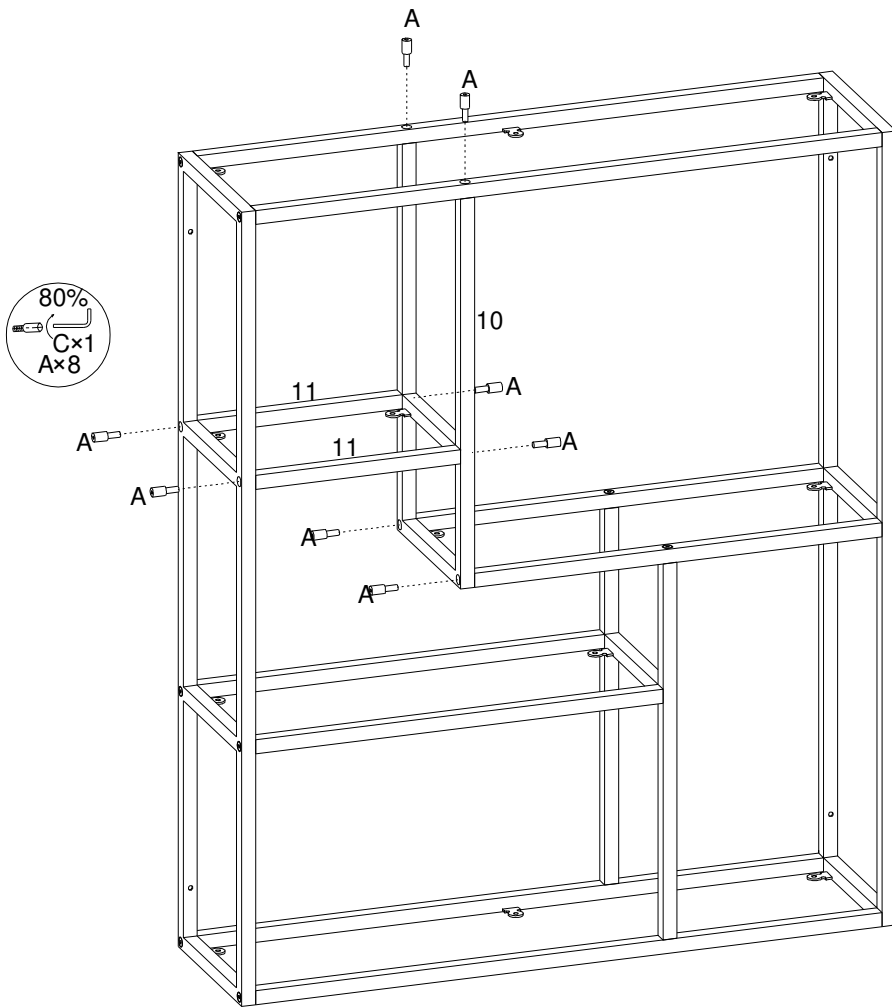

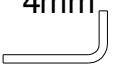

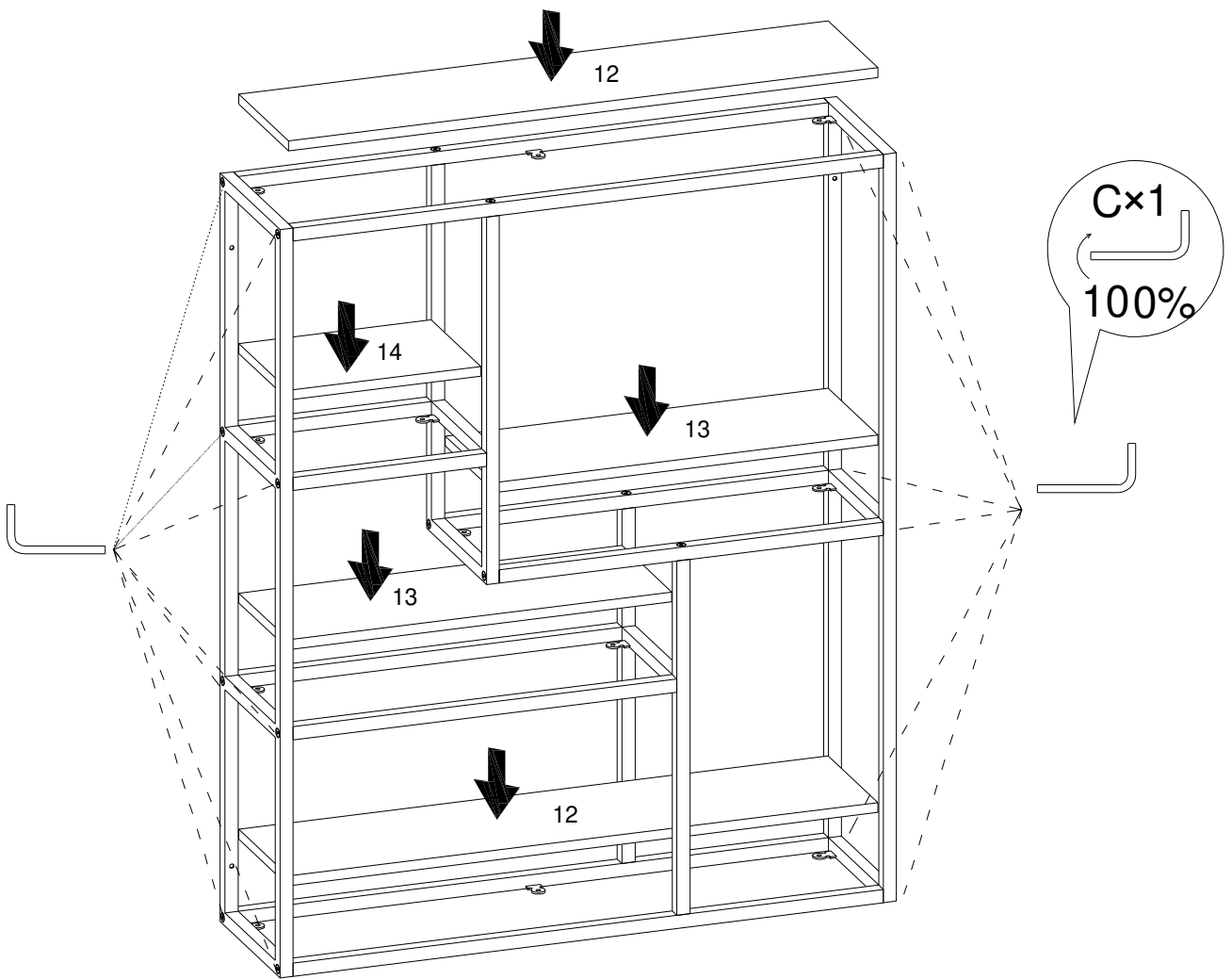
<p>A M6×15mm</p>  <p>8PCS</p>	<p>C 4mm</p>  <p>1PC</p>
---	--



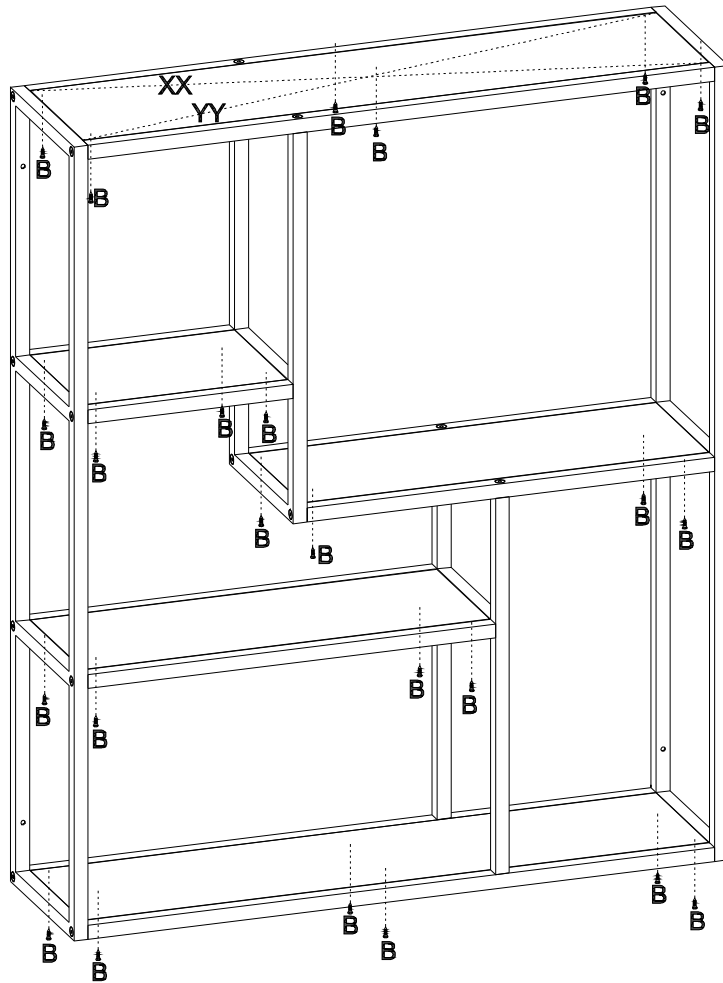

XX=YY



B
M4×12mm

24PCS

