

SCOTT

SLIMISSIMO

Instruction Manual

Model no.: 20200



IMPORTANT INFORMATION

For safety purpose you should read the instructions carefully before using the appliance for the first time. Save the instructions for future reference.

The appliance is designed for domestic use and may only be operated in accordance with these instructions for use.

Always handle with care and warn other users the potential danger.

Danger: The appliance can cause injuries if it is misused.

DO's

1. Check the rating of the appliance and make sure it corresponds to local mains supply.
2. Ensure all packaging materials, labels or stickers are removed from the appliance before the first use.
3. Unwind and straighten the power cord before using the appliance.
4. Place and use the appliance on a dry, flat and stable surface.
5. Use the appliance only in areas where trained personnel can monitor the operation.
6. This appliance is not intended for use by persons with reduced physical, sensory or mental capabilities, or lack of experience and knowledge, unless they have been given supervision or instruction concerning use of the appliance by a person responsible for their safety.
7. Disconnect the appliance from mains supply outlet under the following conditions:
 - Before filling the water tank.
 - Before removing any parts from the appliance or restoring any parts on the appliance.
 - Before cleaning or maintenance.
 - When the appliance is not working correctly.
 - After using the appliance.
8. Empty the water tank when the appliance is not used for a long period of time.
9. Allow to cool the appliance before putting on, taking off parts, before cleaning, or storing the appliance.
10. Always use tap water or distilled water to make coffee or fill the tank. Warm water, hot water, or other liquids can damage the appliance.
11. Use the grinder for grinding coffee bean only.
12. Always ensure that your hands are dry before removing the plug from the mains socket.
13. If the power cord is damaged, it must be replaced by the manufacturer or its service agent or similarly qualified person in order to avoid any hazard.
14. This appliance is intended for household and domestic use only.
15. The plastic bags used to wrap this appliance or the packaging may be dangerous. To avoid risk of suffocation, keep these bags out of reach of babies and children. These bags are not toys.

DO NOT's

1. Do not use or place the appliance on a wet or hot surface, near hot ovens, electric and gas burners.
2. Do not use an extension power cord set unless competent authority has approved it.
3. Do not leave the cord hanging over the edge of a kitchen table, work top or touch hot surfaces.
4. Do not let children play with the appliance.
5. To protect against fire, electric shock and injury, do not immerse the appliance, power cord or plug in water or other liquids.
6. Do not put the appliance in dishwasher.
7. Do not cover the appliance when in use.
8. Do not operate the hot water function continuously for more than one tank of water.
9. Do not unplug the appliance by pulling the power cord from the mains supply.
10. Do not operate the appliance if the drip tray is improperly placed in position.
11. Do not operate the appliance if the power cord or plug has been damaged or if the appliance malfunctions or is damaged in any way. Contact the service agent when in doubt.
12. Do not attempt to open the main body or dismantle any parts from the appliance, there is no serviceable part inside.
13. Do not use any accessories or attachments with this appliance other than those recommended by SCOTT.
14. Do not insert fingers or other objects into the grinder.
15. To disconnect from the mains supply outlet, do not drag the cord itself. Pull by the head of plug.

A. GET TO KNOW YOUR COFFEE MACHINE

I. GENERAL DESCRIPTION

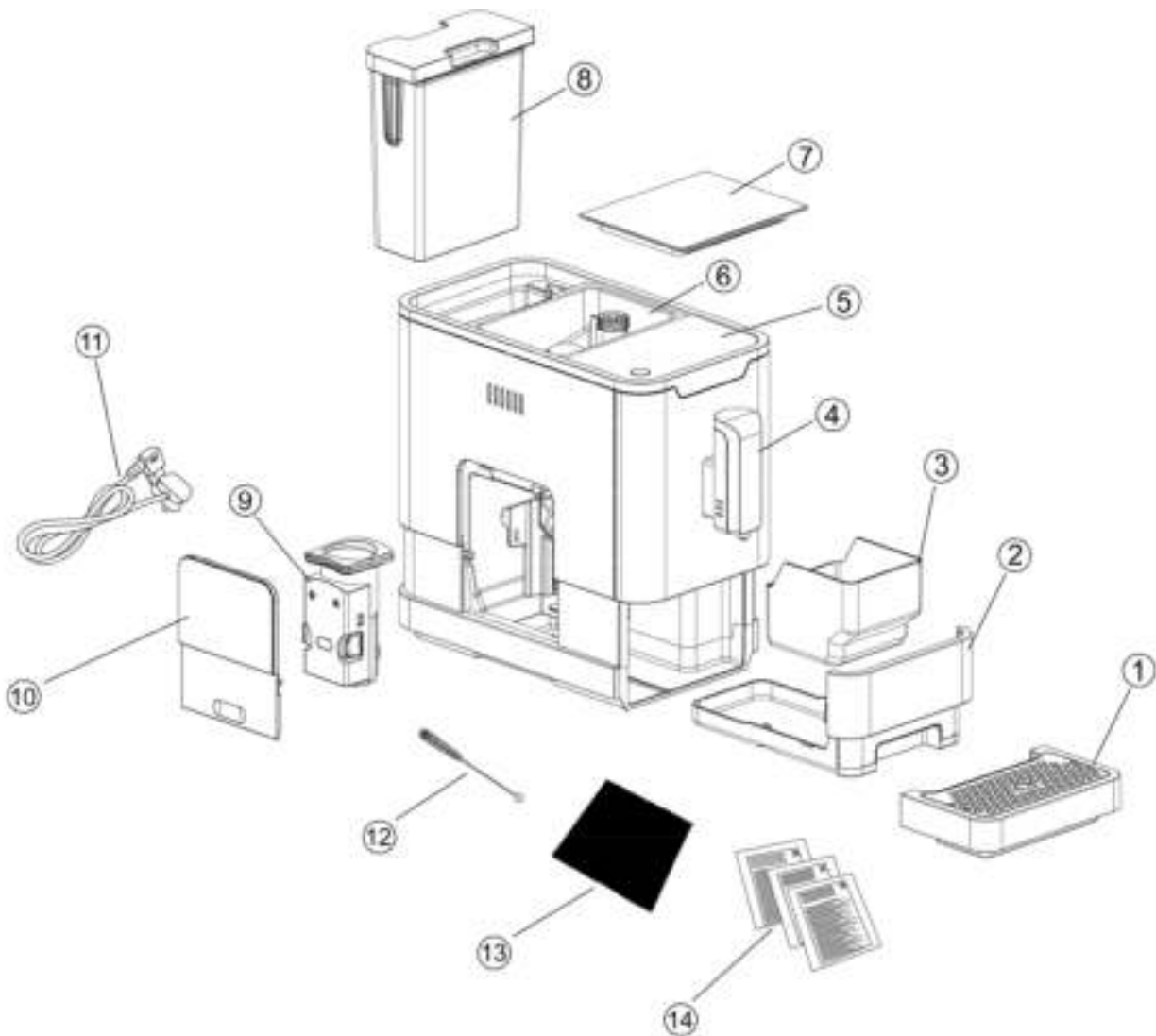

Coffee Machine









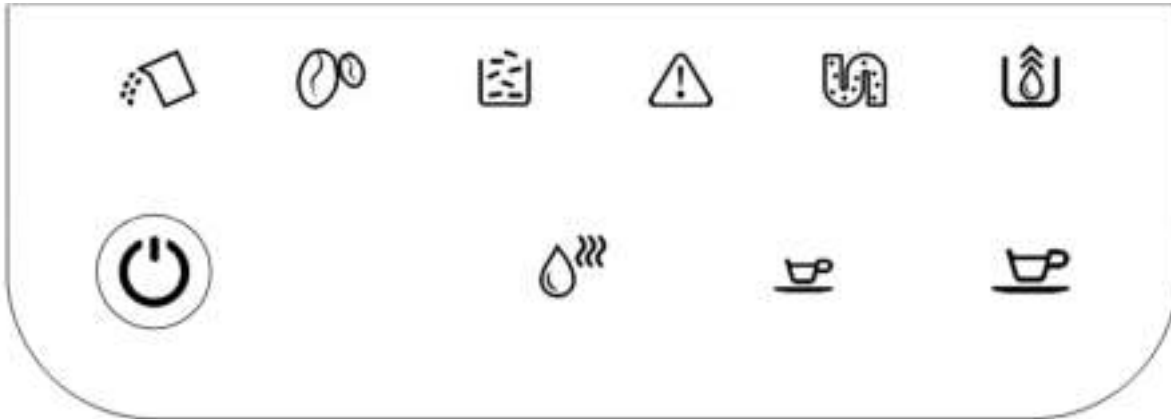

1. External drip tray
2. Internal drip tray
3. Coffee grounds container
4. Adjustable coffee spout
5. Control panel
6. Coffee bean container
7. Coffee bean container lid
8. Water tank
9. Brewer
10. Service door
11. Power cord

Accessories

12. Cleaning brush
13. Cleaning cloth (for control panel)
14. Cleaning agent x 3 packs

CONTROL PANEL



	Power ON/OFF button
	Hot water button
	Espresso button
	Lungo button
	Flashing: Low water level or water tank is missing
	Lack of coffee bean
	Lighting up stably: Coffee grounds container is full Flashing: Internal drip tray or coffee grounds container is missing
	Lighting up stably: Brewer is missing or installed improperly Flashing: Service door is opened or installed improperly
	Lighting up stably: Requires to process descaling Flashing: Descaling is under process
	Empty system function is under process

Note: Touch-sensitive area is located at the lower part of icons. Press the touch-sensitive area firmly in front of the appliance.

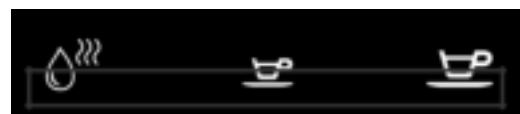

B. MACHINE INSTALLATION

1. Remove all protective films, stickers and other packaging materials from the appliance.

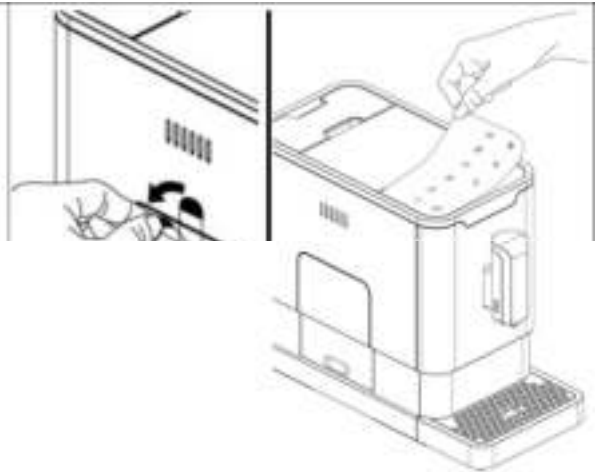

2. Place the appliance on a safe and stable surface with an easily reachable power supply and allow minimum distance from the sides of the machine.

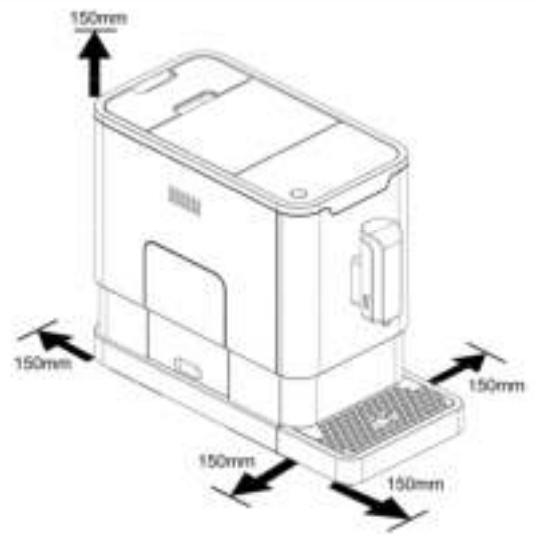

3. Insert the external drip tray, make sure it is inserted correctly.

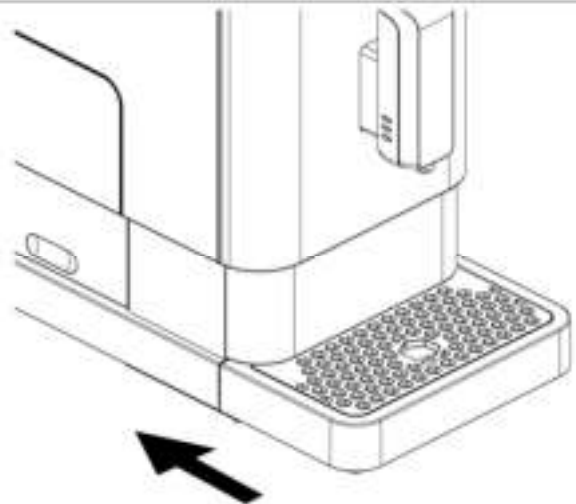

4. Fill the water tank with water.



5. Fill the coffee bean container with coffee beans.



6. Unwind and straighten the power cord and insert the socket into the back of the machine. Insert the plug into a wall socket with suitable power voltage.

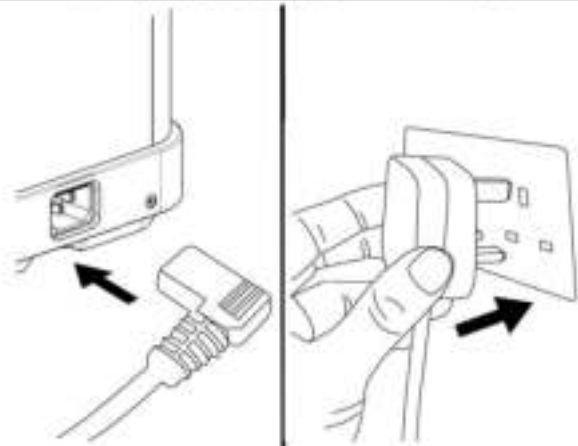

FIRST TIME USE

Press hot water button  to clean inner parts of the coffee machine before first use.



Note: Press the hot water button  anytime to stop cleaning and start coffee making.

C. OPERATION

I. MAKING YOUR COFFEE

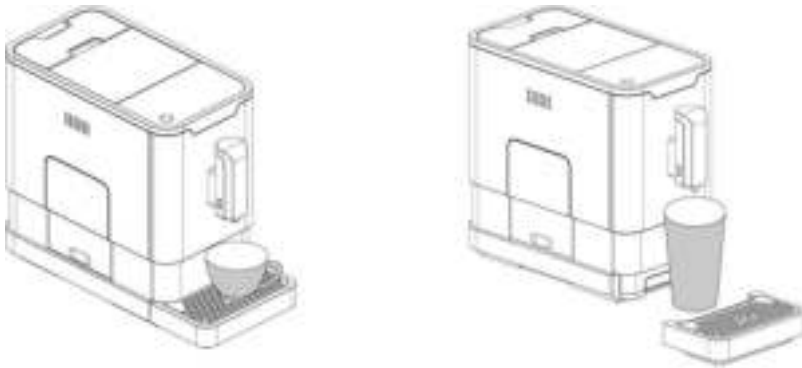
1. Switch on the appliance by pressing the Power ON/OFF button .
2. The appliance is in standby condition.
3. Place a cup under the coffee spout and adjust the height of the spout to fit the cup. Depending on the size or height of the cup, remove the drip tray or adjust the position of the drip tray as below:



4. According to your preference, press Espresso button  or Lungo button  once.
5. The button will flash after pressed. It will then light up to indicate that the appliance is preparing the coffee.
6. When the appliance resumes to standby condition, the coffee is ready to serve.

II. FILLING THE WATER TANK

When  is flashing, water level in the water tank is too low and filling is necessary.

1. Use the integrated handle on the lid to lift the water tank.

Note: To prevent overflow of water from the water tank, do not fill water directly into the container.

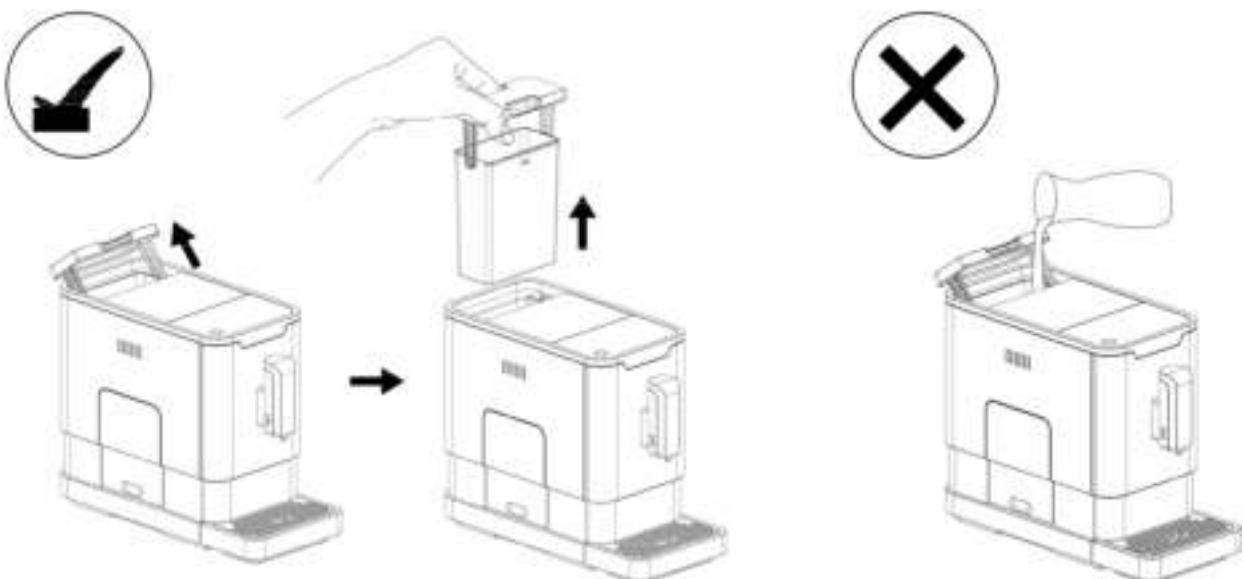

2. Rinse the water tank with fresh water and fill the tank to “MAX” level. Place it into the machine and make sure it is fully inserted.

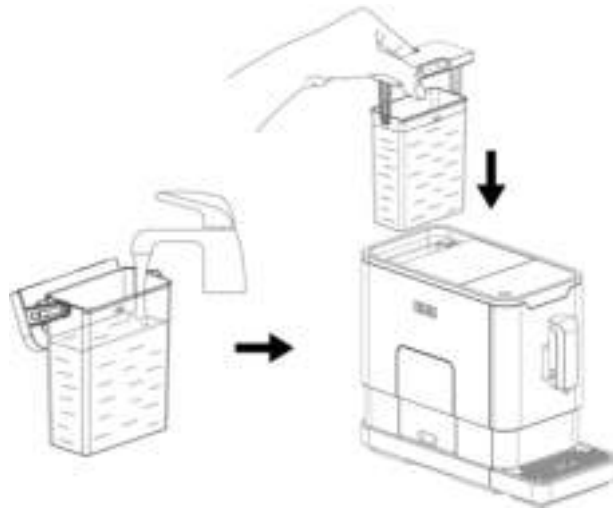

Important: Never fill the water tank with warm, hot, sparkling water or any other liquids which can damage the water tank and the machine.

III. FILLING THE COFFEE BEAN CONTAINER

When  is flashing, the appliance needs to be filled with coffee beans.

1. Remove the bean container lid.



2. Slowly pour in the coffee beans.
3. Place the bean container lid to its original position.

Important: Fill the coffee bean container with coffee beans only. Do not use ground coffee, instant coffee powder, caramelized coffee bean and any other objects.





IV. HOT WATER

Hot water can be dispensed by pressing the hot water button . The hot water button will light up and the appliance is preparing the hot water. When the light turns off, the water is ready to serve.

Note : Press the hot water button  anytime to stop.

V. DAILY CLEANING OF THE APPLIANCE

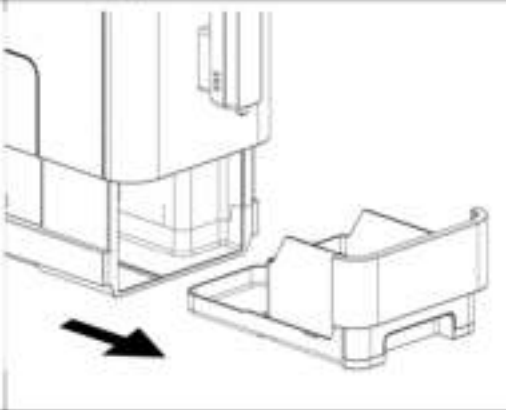
Timely cleaning and maintenance of the appliance is very important to prolong the life of the appliance.

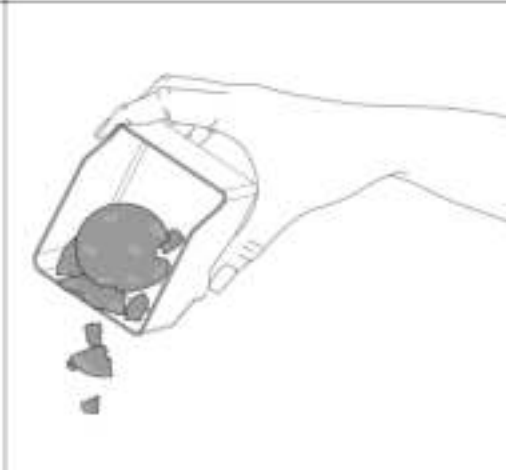
<p>1. Remove the external drip tray.</p>	
<p>2. Drain the drip tray over sink and wash it with fresh water. Dry it afterwards.</p>	
<p>3. Pull out the internal drip tray and the coffee grounds container.</p>	
<p>4. Empty the coffee grounds container and wash it with fresh water. Dry it afterwards.</p> <p>Note: When  lights up, empty the coffee grounds container.</p>	

5. Push the recess area of service door.



6. Remove the service door.

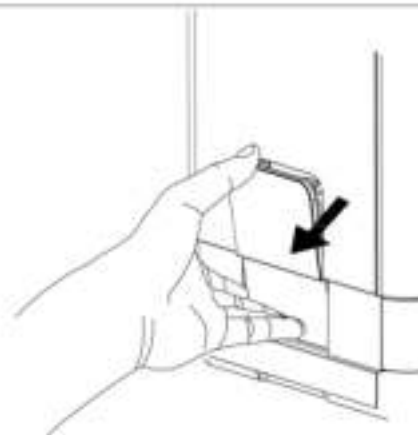

7. Press the release buttons firmly.

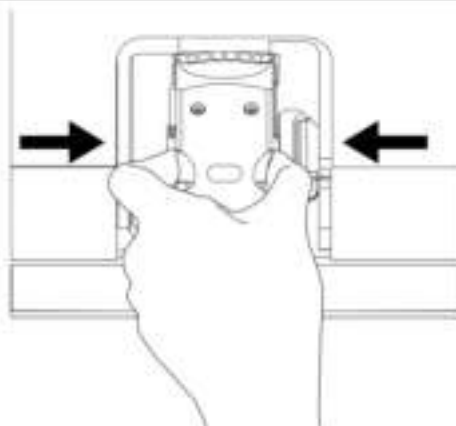

8. Remove the brewer.



9. Wash the brewer with fresh water. Dry it afterwards.



10. Insert the brewer to its original position and install the service door to its original position.

Note: When  lights up stably, it indicates that the brewer is missing or installed improperly.

When  flashes, it indicates that the service door is missing or installed improperly.

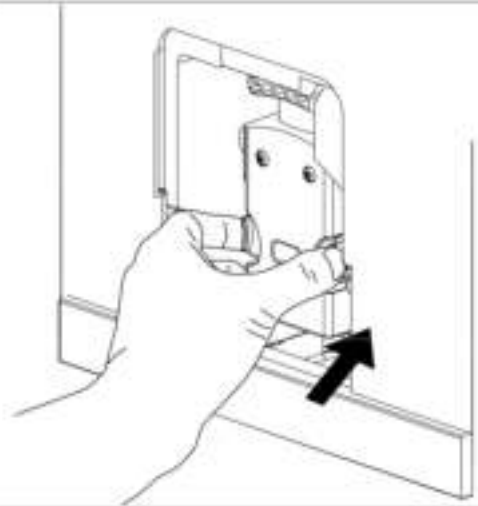

11. Place the coffee grounds container on the internal drip tray and insert into its original position.

Note: When  flashes, the coffee grounds container is missing.

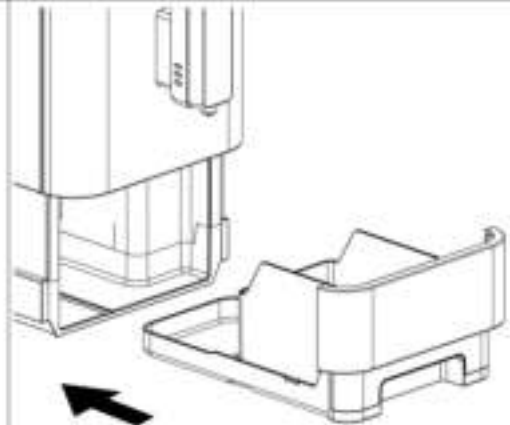

12. Place the external drip tray to its original position.



VI. TURNING OFF THE MACHINE

Switch off the appliance by pressing the Power ON/OFF button.

VII. AUTO-SHUT OFF

The Appliance is equipped with auto-shut off function (see D. FURTHER SETTING – III. MODE SELECTION). The default auto-shut off time varies with the mode selected.

D. FURTHER SETTING

I. ADJUSTING THE VOLUME OF YOUR COFFEE / HOT WATER

The desired volume of Espresso, Lungo and hot water can be memorized, ranging from 25ml to 250ml.

1. To make your coffee (either Espresso or Lungo) or dispense hot water, press and hold the relative button, the appliance will make the drink.
2. When the drink reaches your desired volume, release the button. Two beep sounds will be heard which indicates that the volume is memorized. You can get the exact volume of coffee every time during future use.
3. Reset the volume to factory setting by selecting default setting (see D. FURTHER SETTING - III. MODE SELECTION)

II. GRINDING ADJUSTMENT

You can adjust the grind size to suit your coffee taste by turning the knob in the coffee beans container:

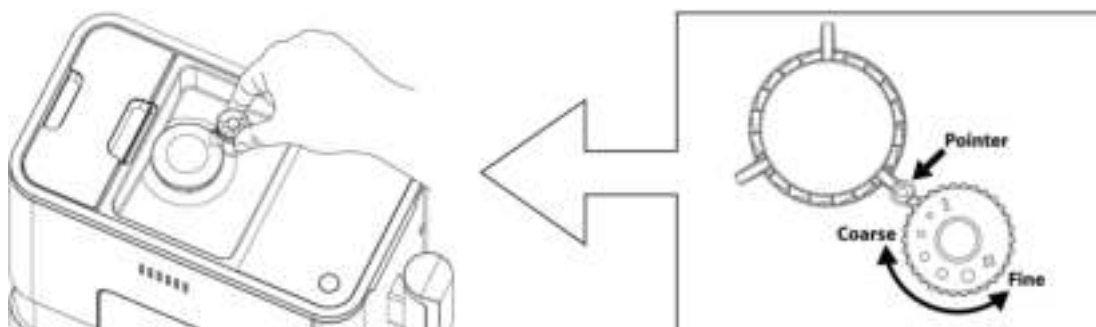



1. Only turn the knob for adjustment when grinder is in operation.
Caution: Never adjust the grinding when the grinder is not operating. It can damage the grinder.
2. The dots on adjuster knob indicate the grinding fineness. Turn the knob to the pointer, clockwise for a coarser grind and counter-clockwise for a finer grind.



III. MODE SELECTION

The machine is equipped with different settings: Default Setting, ECO Mode and Speed Mode. ECO Mode helps save energy, Speed Mode can make coffee more quickly than in default setting.

	Default Setting	Speed Mode	ECO Mode
Illumination light	Yes	Yes	No
Pre-brewing *	Yes	No	Yes
Auto shut off time	20 mins	29 mins	10 mins
Cup volume memory	Yes	Yes	Yes

*The pre-brewing function pre-wets the ground coffee in the brewer with a small amount of water before extraction. This will provide better extraction performance and a coffee with better quality.

1. When the machine is in standby condition, press  and hold for 5 seconds.
2. The  will flash and the following buttons will have the following indications in different settings :

	Hot water button 	Espresso button 	Lungo button 
In ECO Mode	Lights on	Flashing	Flashing
In Speed Mode	Flashing	Lights on	Flashing
In Default Setting	Flashing	Flashing	Lights on

3. Press the hot water button for ECO mode, Espresso button for Speed mode and Lungo button for Default setting. Two beep sounds will be heard which indicates that the mode is selected. (Note: If the relative lighted button for each mode is pressed, the machine will not respond).
4. To remain the setting unchanged, press  or wait for 5 seconds for the machine to return to standby condition.

E. CLEANING & MAINTENANCE







I. DESCALING

When  is flashing, it indicates that the appliance needs to undergo descaling. The appliance will remain in the best condition if this function is performed at least once a month or more regularly depending on the hardness of water used. Follow the procedures below:

Note: The complete descaling process will take approximately 30 minutes. Do not switch off the appliance or unplug during the process.



1. Fill the water tank to “MAX” level.
2. Add one pack of cleaning agent into the water tank.

Important: Do not use vinegar or other cleaning agents to do descaling for this appliance. It can damage the appliance.

3. Plug in the appliance.
4. Place a large container with at least 1.5L capacity under the coffee spout.
5. Switch on the appliance.
6. Press and hold  and Espresso button  simultaneously for 5 seconds. A beep sound will be heard,  and Espresso button  will be flashing.
7. Press Espresso button  to confirm to undergo descaling process.
8.  will be flashing which indicates that the appliance is undergoing descaling process.





Note: Small amount of water will periodically dispense automatically during the descaling process.

Caution: Hot water can burn or scald. Do stay away.

9. When all water in the water tank is dispensed out,  and Espresso button  will be flashing. Remove all the remaining cleaning agent in the water tank, fill the tank with tap water to the “MAX” level. When water is filled,  will stop flashing. The appliance will continue the descaling process.
10. When the descaling process completes, the appliance will switch off automatically.

II. EMPTY SYSTEM FUNCTION





It is recommended to use the empty system function before storing or before taking to repair agent.

1. Switch on the appliance.
2. Press and hold the  button and Lungo button  simultaneously for 5 seconds.
3.  will then be flashing.
4. Remove the water tank from the appliance.  will light up stably and indicate that the empty system is under process. The coffee spout will dispense a small amount of water.
5. After completing the empty system function, the appliance will switch off automatically.

Important: Press hot water button  to clean the inner parts of the coffee machine when it is used again.

III. MANUAL RINSING

Perform a manual rinsing cycle to clean the coffee spout after use, or after the appliance is stored for a long period of time.

1. Switch on the appliance.
2. Press and hold the Power ON/OFF button  and hot water button  simultaneously for 5 seconds.
3. The hot water button , Espresso button  and Lungo button  will go off.
The coffee spout will dispense a small amount of water.

Danger: Hot water will be dispensed from the spout into the external drip tray. Be careful to avoid scalding yourself.

4. After rinsing, the appliance will resume to standby condition.

IV. CLEANING THE APPLIACNE

1. Disconnect the power cord from the mains supply outlet.
2. Pour away all water in the internal and external drip tray.
3. Use a dampened cloth or non-scratching cleaner to clean the water stains on the appliance.

Important: Never use any abrasive, vinegar or descaling agents not included in the box to clean the appliance.

V. CLEANING COFFEE GROUNDS OUTLET

After using the appliance for a long period of time, coffee grounds may stick on the wall of grounds outlet. It is recommended to clean the outlet by following the steps below to ensure that coffee grounds can be delivering to the brewer.

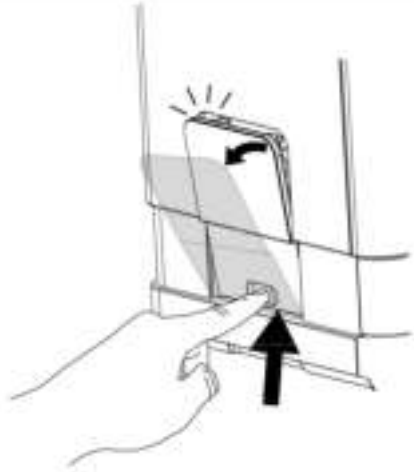
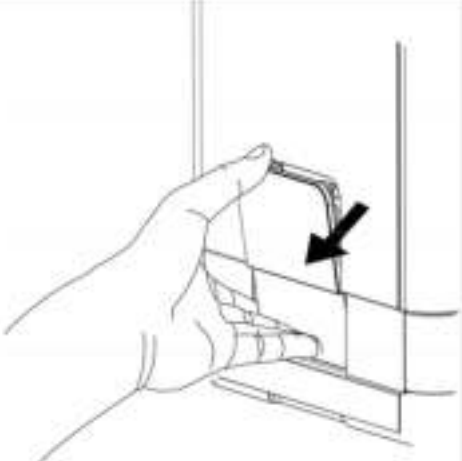
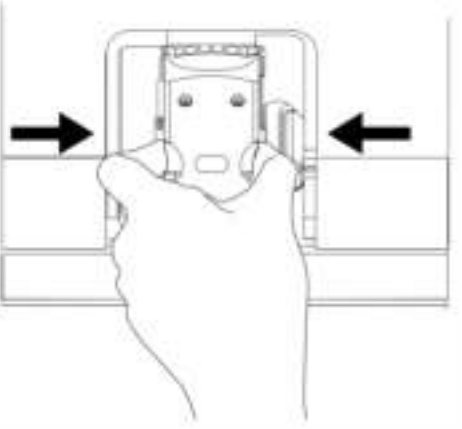
<p>1. Push the recess area of service door.</p>	 A line drawing showing a hand with the index finger pointing to a small rectangular recessed area on the bottom edge of a service door. A thick black arrow points upwards from the finger towards the recessed area. Above the door, there are vertical lines representing the coffee outlet's interior.
<p>2. Remove the service door.</p>	 A line drawing showing a hand pulling the service door away from the appliance. A thick black arrow points downwards and to the right, indicating the direction of removal. The door is shown partially detached from the main body of the appliance.
<p>3. Press the release buttons firmly.</p>	 A line drawing showing a hand reaching into the coffee outlet. Two thick black arrows point horizontally outwards from the sides of the hand, indicating the direction of pressure being applied to the release buttons. The coffee outlet's internal components are visible.

4. Remove the brewer.

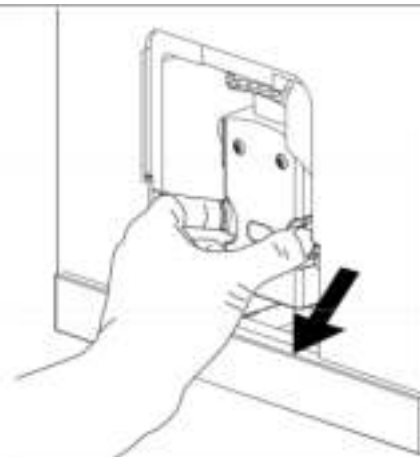

5. Wash the brewer with fresh water.



6. Use cleaning brush to clean the grounds outlet.

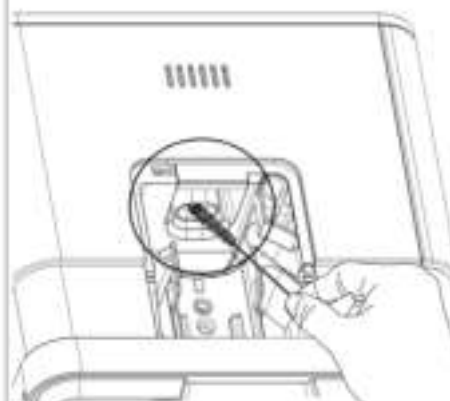

7. After completing all cleaning processes, replace all units to original position.

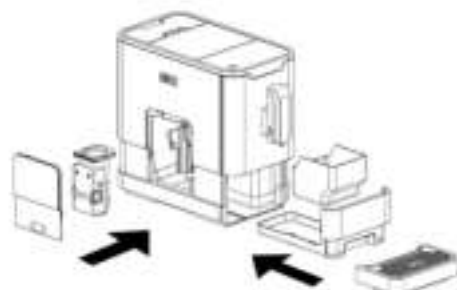

F. TROUBLESHOOTING

The appliance does not work.

Possible Cause	Solution
- The appliance is not connected to the mains supply.	- Plug in and press the Power ON/OFF button. - Check the cord and the plug.

No or delayed response in several trials of pressing the function keys on panel.

Possible Cause	Solution
- Appliance is under electromagnetic interference. - Dirt on the panel.	- Unplug the appliance. Restart after few minutes. - Clean the panel with the cloth provided.

The coffee is not hot enough.

Possible Cause	Solution
- The cups have not been preheated. - The brewer is too cold.	- Warm the cups. - Rinse the appliance at least 3 times before making the coffee.

The coffee cannot come out from spout.

Possible Cause	Solution
- Empty system function might be used before.	- Press the hot water button until water can come out from spout.

Quality of the first cup of coffee is poor.

Possible Cause	Solution
- The first run of grinder does not deliver sufficient quantity ground coffee into the brewing unit.	- Make another cup of coffee, the quality will be improved.

Coffee has no cream.

Possible Cause	Solution
- Coffee beans are not fresh.	- Use fresh coffee beans.

The appliance takes long time to heat up.

Possible Cause	Solution
- Excessive scale has built up.	- Descale the appliance.

There is no alert when the water tank is removed or the water level in tank is low.

Possible Cause	Solution
- The area near the water tank connector is wet.	- Wipe the water around the water tank connector.

Internal drip tray is filled with water.

Possible Cause	Solution
- Ground coffee is too fine which block the water to come out.	- Adjust the grind size to coarser level.

Coffee is delivered too slowly or a drop at a time.

Possible Cause	Solution
- Ground coffee is too fine which block the water to come out.	- Adjust the grind size to coarser level.

Lack of beans indicator still flashes even there are coffee beans inside the container.

Possible Cause	Solution
- Internal coffee grounds outlet is blocked.	- Follow the steps of section E (V. CLEANING COFFEE GROUNDS OUTLET).

RECYCLING YOUR ELECTRICALS



At the end of the electrical products useful life, it should not be disposed of with household waste. Please arrange to take this appliance to recycling points set up around the country.

To find out more information about the recycling of electrical items and the recycling point, please visit www.recycle-more.co.uk .

SCOTT SMART PRODUCTS (UK) LTD
The Lansdowne Building, 2 Lansdowne Road, Croydon, England, CR9 2ER