

LC-POWER™

LC-M24-FHD-165

GAMING MONITOR



BEDIENUNGSANLEITUNG

INHALT

1. Sicherheitshinweise
2. Wartung
3. Verpackungsinhalt
4. Produktübersicht
5. Standfußinstallation
6. Wandmontage
7. Leuchtanzeige
8. OSD-Menü
9. ECO-Modi und Gameplus
10. Technische Daten

1. SICHERHEITSHINWEISE

Setzen Sie den Monitor nicht einer feuchten Umgebung, Regen oder anderen Flüssigkeiten aus.

Öffnen Sie nicht das Monitorgehäuse. Es besteht akute Stromschlaggefahr durch Hochspannung innerhalb des Monitors!

Betrieb:

- Halten Sie den Monitor von direkter Sonneneinstrahlung und anderen Wärmequellen (z. B. Heizungen) fern.
- Halten Sie jegliche Flüssigkeiten vom Monitor fern.
- Achten Sie darauf, dass keine Objekte in die Belüftungsöffnungen fallen können.
- Blockieren Sie die Belüftungsöffnungen nicht, um eine Überhitzung zu vermeiden.
- Schlagen Sie nicht gegen den Monitor und lassen Sie das Gerät nicht fallen.

2. Wartung

ACHTUNG: Ziehen Sie das Netzkabel aus der Steckdose, bevor Sie den Monitor reinigen.

- Zum Reinigen des Bildschirms benutzen Sie ein weiches Tuch, das Sie leicht (!) mit destilliertem Wasser angefeuchtet haben.
- Verwenden Sie am besten spezielle Reinigungstücher für Bildschirme.
- Benutzen Sie keinesfalls Benzin, Verdünnung, sehr saure oder alkalische Mittel, Scheuermittel oder Druckluft!
- Ungeeignete Reinigungsmittel können den Monitor beschädigen und unschöne Schlieren auf dem Bildschirm und dem Gehäuse hinterlassen.
- Ziehen Sie den Netzstecker, wenn Sie den Monitor längere Zeit nicht benutzen.
- Halten Sie den Monitor von sämtlichen Flüssigkeiten, Staub und Feuchtigkeit fern.
- Falls der Monitor mit Flüssigkeiten in Berührung gerät, wischen Sie ihn sofort mit einem Tuch trocken.
- Falls Flüssigkeiten in die Belüftungsöffnungen eindringen, ziehen Sie sofort den Netzstecker und benutzen Sie den Monitor nicht mehr. Bitte wenden Sie sich an einen professionellen Servicetechniker.

Rechtliche Hinweise:

HDMI[™]
HIGH-DEFINITION MULTIMEDIA INTERFACE

HDMI, das HDMI-Logo und „High-Definition Multimedia Interface“ sind Marken oder eingetragene Marken der HDMI Licensing Administrator LLC in den USA und anderen Ländern.

3. Verpackungsinhalt



Monitor

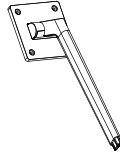

Halterung



Basis

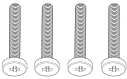

Schrauben (CM4*23) x 4

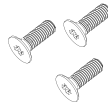

Schrauben (KM3*14) x 3

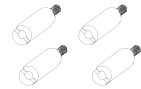

Schrauben M4*33mm x 4
(zur Wandmontage)

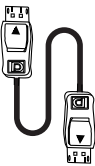

DP-Kabel

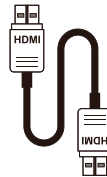

HDMI-Kabel

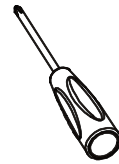

Schraubendreher x 1

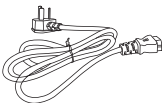

Netzkabel x 1

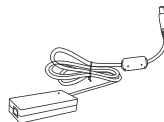

Netzteil x 1



Bedienungsanleitung



Eventuell sind zusätzliche Schrauben als Ersatz beigelegt.

Ger-2

4. Produktübersicht

4.1 — Monitortasten

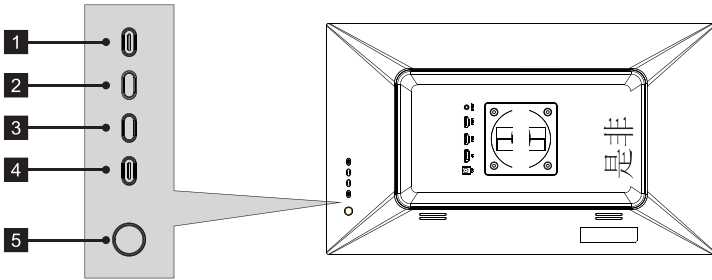

- 1 Menütaste (M):** ruft das OSD-Menü auf und greift auf die Untermenüs zu.
- 2 ▲ Abwärtstaste:** navigiert in den Menüs nach unten.
- 3 ▼ Aufwärtstaste:** navigiert in den Menüs nach oben.
- 4 Verlassen-Taste (E):** verlässt das Menü.
- 5 Ein-/Austaste:** Schaltet den Monitor ein und aus.

4.2 — Monitoranschlüsse

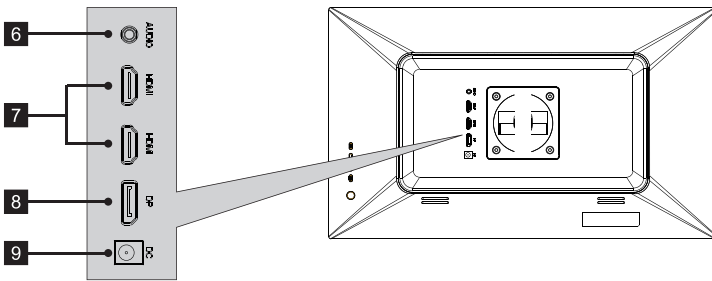

- 6 Audioausgang:** Schließen Sie das Audiokabel zur Ausgabe von Audiosignalen an.
- 7 HDMI-Anschlüsse:** Schließen Sie einen Stecker des HDMI-Kabels an den HDMI-Ausgang des Computers und den anderen Stecker an den HDMI-Port des Monitors an.
- 8 DP-Anschlüsse:** Schließen Sie einen Stecker des DP-Kabels an den DP-Ausgang des Computers und den anderen Stecker an den DP-Port des Monitors an.
- 9 Netzanschluss:** Hier schließen Sie das Netzkabel zur Stromversorgung des Monitors an.

5. Standfußinstallation

1. Öffnen Sie die Verpackung und nehmen Sie das Produkt mit dem Styropor heraus. Legen Sie es vorsichtig auf eine Tischoberfläche.



2. Entfernen Sie das obere Schaumstoffteil, nehmen Sie den Monitor aus dem Kunststoffbeutel heraus und setzen Sie den Monitor wieder in den Hohlraum des unteren Schaumstoffteils ein.

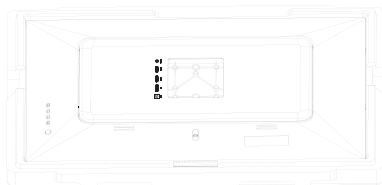

3. Montieren Sie die Basis mit zwei KM4*12-mm-Schrauben an der Halterung wie unten abgebildet.

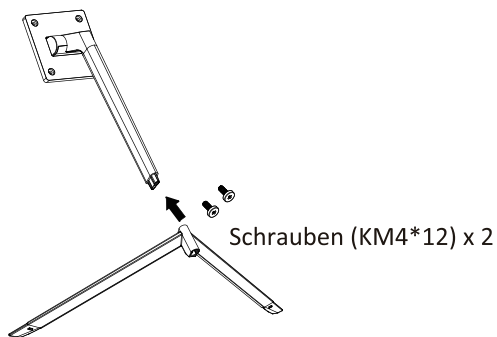

4. Befestigen Sie den montierten Standfuß mit vier M4*23-mm-Schrauben an der Rückseite des Monitors.

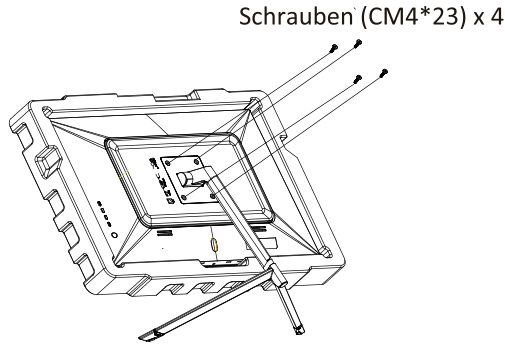

5. Stellen Sie den Monitor aufrecht, indem Sie die Halterung mit den Händen greifen.
(Hinweis: Beim Aufstellen des Geräts keinen direkten Druck mit den Händen auf den Bildschirm ausüben, damit dieser nicht beschädigt wird)

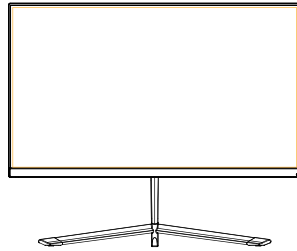
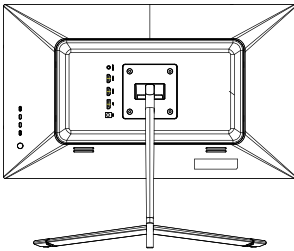

Legen Sie den Monitor auf eine flache Unterlage, bevor Sie den Ständer abnehmen.

6. Wandmontage



Die mitgelieferten Schrauben eignen sich ausschließlich zum Fixieren des Monitors an einer VESA-Halterung mit 75*75 mm Schraubenabstand. VESA-Halterungen und Montagezubehör erhalten Sie separat im Fachhandel.

1. Öffnen Sie die Verpackung und nehmen Sie das Produkt mit dem Styropor heraus. Legen Sie es vorsichtig auf eine Tischoberfläche. Entfernen Sie das obere Schaumstoffteil, nehmen Sie den Monitor aus dem Kunststoffbeutel heraus und setzen Sie den Monitor wieder in den Hohlraum des unteren Schaumstoffteils ein.

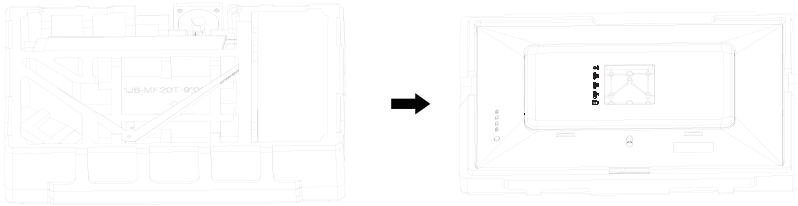

2. Nehmen Sie die vier mitgelieferten M4-Schrauben und schrauben Sie sie in das M4-Gewindeloch auf der Rückseite des Monitors fest. (Hinweis: Während der Installation der Schrauben bleibt der Monitor auf der unteren Abdeckung des Styropors.)

Schrauben (M4*33) x 4

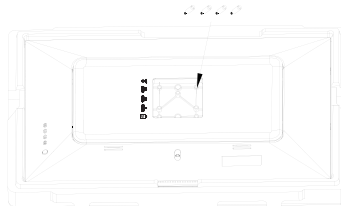

3. Drücken Sie den Bildschirm beim Aufhängen des Produktes nicht mit Ihren Händen zusammen, damit er nicht beschädigt wird.

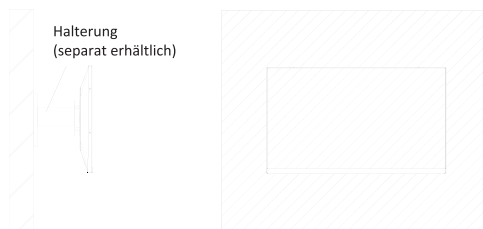

7. Leuchtanzeige

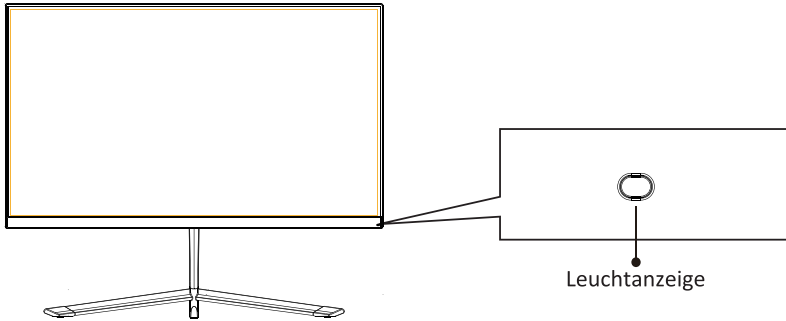

Blaues Leuchten bedeutet, dass der Monitor mit Strom versorgt wird und normal arbeitet.

Blaues Blinken signalisiert, dass keine Videoquelle (kein Horizontal- oder Vertikalsignal) erkannt wurde oder die Spannung zu gering ist. Vergewissern Sie sich, dass Ihr Computer eingeschaltet ist und dass das DP- oder HDMI-Kabel richtig angeschlossen und komplett eingesteckt wurde.

8. OSD-Menü

Mit dem OSD-Menü (On-Screen Display) können Sie die Monitoreinstellungen anpassen. Das OSD-Menü erscheint, wenn Sie bei eingeschaltetem Monitor die M-Taste drücken.





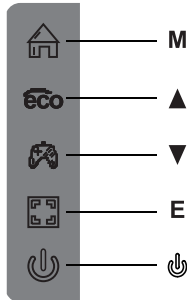

Wenn Sie den Monitor zum ersten Mal benutzen, passen sich die Einstellungen automatisch der Konfiguration Ihres Computers an.

1. Drücken Sie eine beliebige Taste (**M**, **▲**, **▼**, **E**, **⏻**), um das Navigationsfenster zu öffnen.

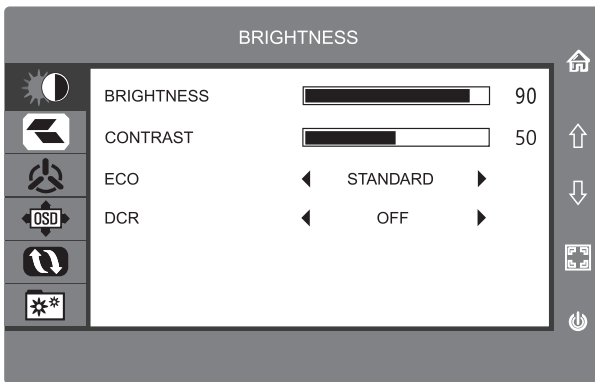

2. Drücken Sie **M** (), um in das OSD-Menü zu gelangen.



3. Drücken Sie **↑** oder **↓**, um durch die Funktionen des OSD-Menüs zu navigieren.
 - Markieren Sie die gewünschte Funktion und drücken Sie (), um in das entsprechende Untermenü zu gelangen.
 - Drücken Sie **↑** oder **↓**, um das Untermenü zu durchsuchen. Drücken Sie dann (), um die einzustellende Funktion auszuwählen.
 - Drücken Sie **↑** oder **↓** zum Hervorheben der Optionen und drücken Sie dann die () Taste zum Bestätigen der Einstellungen und zum Verlassen des aktuellen Menüs.
4. Drücken Sie die Taste , um die aktuelle Ebene zu verlassen.

8.1 — OSD-Menüfunktionen

Hauptmenü	Untermenü	Optionen	Beschreibung
Helligkeit	Helligkeit	0 bis 100	Zum Einstellen der Helligkeit.
	Kontrast	0 bis 100	Zum Einstellen des Kontrastes.
	ECO	Standard, Spiel, RTS, FPS, Film, Text	Zum Einstellen des visuellen Modus
	DCR	Ein	Zum Einschalten der DCR-Funktion.
		Aus	Zum Abschalten der DCR-Funktion.
Bild	H. Position	0 bis 100	Die horizontale Position des Quellbilds anpassen.
	V. Position	0 bis 100	Die vertikale Position des Quellbilds anpassen.
	Takt	0 bis 100	Die Bildtaktung für weniger vertikales Zeilenrauschen anpassen.
	PHASE	0 bis 100	Die Bildphase für weniger Rauschen anpassen.
	Seitenverhältnis	Breitbild, Auto, 4:3,	Seitenverhältnis einstellen
Farbtemperatur	Farbtemperatur	Warm, Benutzer, Kühl	Zum Anpassen der Farbtemperatur
	Rot	0 bis 100	Zum Anpassen der RGB-Komponenten
	Grün	0 bis 100	
	Blau	0 bis 100	
OSD-Einstellung	Sprache	English , Español , Русский , Français , 한국 , Português , Deutsch , Türkçe , 简体中文 , Polski , Italiano , Nederlands , 日本語	Zur Auswahl der OSD-Sprache.
	OSD H. POS.	0 bis 100	Zum Anpassen der horizontalen OSD-Position
	OSD V. POS.	0 bis 100	Zum Anpassen der OSD-Vertikalposition.
	OSD-Timer	0 bis 60	Zum Einstellen, wie lange das OSD-Menü im Leerlauf angezeigt wird.
	Transparenz	0 bis 100	Zum Einstellen der OSD-Transparenz.

Hauptmenü	Untermenü	Optionen	Beschreibung
Rücksetzen	Rücksetzen	/	Zum Rücksetzen der Monitorkonfiguration.
	AUTOM. BILDANPASSUNG	/	Zum automatischen Anpassen des Bildes
	AUTOM. FARBANPASSUNG	/	Zum automatischen Anpassen der Farbe
MISC	Signalquelle	HDMI 1, HDMI 2, DP	Zeigt das Bildsignal an
	Lautstärke	0 – 100	Zum Anpassen der Lautstärke.
	Blaulicht reduzieren	0 – 100	Zum Einstellen der Blaureduktion.
	Übersteuerung	Mittel, Niedrig, Aus	Siehe Übersteuerungsfunktion
	LED-Effekte	Aus, Normal, Flimmern	
	Adaptive Sync	Ein, Aus	Zum Ein-/Ausschalten der FreeSync-Funktion

9. ECO-Modi und Gameplus

1. Drücken Sie eine beliebige Taste (M, ▲, ▼, E, ⏻), um das Navigationsfenster zu öffnen.

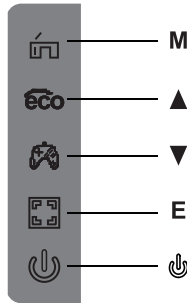

2. Drücken Sie die Taste ▲, um die ECO-Modi zu wechseln. Zu diesen Modi zählen Standard, Text, Film, Spiel, FPS und RTS. Diese können genutzt werden, um die Einstellungen entsprechend Ihrer Nutzung zu optimieren. Der Standardmodus ist für die meisten Anwendungen geeignet.



3. Drücken Sie die Taste ▼, um zum Gameplus-Modus zu wechseln. Wählen Sie das entsprechende Spielesymbol, das am besten zu Ihrem Spiel passt. Die Symbole wurden primär dazu entworfen, Ihre Zielfähigkeit in Shooter-Spielen zu verbessern, können aber natürlich auch in anderen Szenarios genutzt werden.



10. Technische Daten

Modell	LC-M24-FHD-165
Bildschirmgröße	23,8 Zoll
Bildformat	16:9
Beleuchtung	LED
Helligkeit	250cd/m ²
Panel	IPS
Auflösung	DP1.2: 1920 × 1080 bei 165Hz HDMI 1.4: 1920 × 1080 bei 120Hz
Bildwiederholfrequenz	165 Hz
Reaktionszeit	Schnell 1 ms
Betrachtungswinkel	≥ 178°(H) / ≥ 178°(V)
Kontrastverhältnis	1000:1
VESA-Montage	75 x 75mm
Farben	16,7M
Adaptive Sync	Ja
Signaleingang	DP 1.2 x 1, HDMI 1.4 x 2, Audioausgang x 1
Audio	
Lautsprecher	Nein
Audioausgang	Ja
Zubehör	
Netzteil	Ja
DisplayPort-Kabel	Ja
Weitere Funktionen	
Blaureduktion	Ja
Abmessungen	
Abmessungen (mit Ständer)	543,5*498,2*200 mm
Abmessungen (ohne Ständer)	543,5*323,5*45,3 mm
Nettogewicht	4,7kg
Bruttogewicht	6,66 kg

TABLE OF CONTENTS

1. Safety Precautions
2. Maintenance
3. Box Contents
4. Product Overview
5. Stand Installation
6. Wall mounting
7. Indicator Light
8. OSD Menu
9. ECO Modes and Gameplus
10. Technical Specifications

1. SAFETY PRECAUTIONS

Do not expose the monitor to a humid environment, rain or other liquids. Do not open the monitor housing to avoid any shock due to electrical or mechanical hazards.

Operation:

- Keep the monitor out of direct sunlight or other heat sources like stoves.
- Keep the monitor away from any liquid.
- Remove any object that could fall into the ventilation holes.
- Do not block the ventilation holes to avoid overheating.
- Do not knock or drop the monitor.

2. MAINTENANCE

CAUTION: Unplug the power cable from the outlet before cleaning the monitor.

- To clean your screen, slightly moisten a soft, clean cloth with water.
- Please use a special screen-cleaning tissue if possible.
- Do not use benzene, thinner, ammonia, abrasive cleaners or compressed air.
- Inappropriate cleaning solutions may damage the monitor or leave a milky film on screen or housing.
- Unplug the monitor if you are not going to use it for a longer time period.
- Do not expose the monitor to dust, liquids or a humid environment.
- In case the monitor gets in touch with any liquid, wipe it down immediately using a dry cloth.
- In case any liquid gets spilled into the ventilation holes, do not use the monitor anymore. Please contact a professional service technician.

Legal notice:



The terms HDMI and HDMI High Definition Multimedia Interface and the HDMI logo are trademarks or registered trademarks of HDMI Licensing Administrator, Inc. in the USA and other countries.

3.Box Contents



Monitor

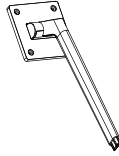

Stand



Base

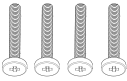

CM4*23 Screw Bolts X 4



KM3*14 Screw Bolts X 3

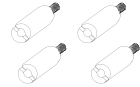

M4*33mm x 4 Screw Bolts
(for wall mounting)



DP Cable

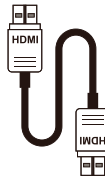

HDMI Cable



Screwdriver x 1

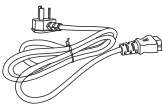

Power Cable x 1

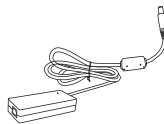

Power Adapter x 1



User Manual



Extra screws may be included as backup.

4. Product Overview

4.1 — Monitor Buttons

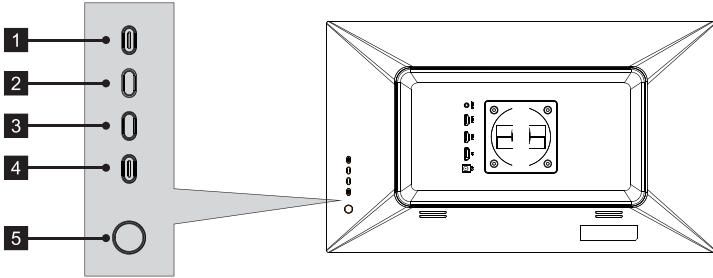

- 1 M Menu Button:** Press to display the OSD menu or enter sub-menus.
- 2 ▲ Up Button:** Press to move up in the menus.
- 3 ▼ Down Button:** Press to move down in the menus.
- 4 E Exit Button:** Press to exit.
- 5 ⏻ Power Button:** Press to turn the monitor on/off.

4.2 — Monitor Ports

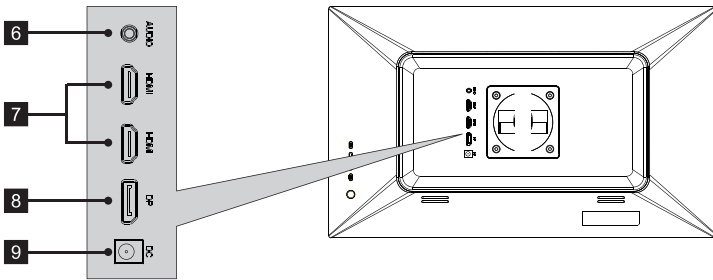

- 6 Audio Output:** Insert the audio cable for output of audio signals.
- 7 HDMI Connectors:** Insert one end of the HDMI cable into the computer's HDMI output and connect the other end to the monitor's HDMI port.
- 8 DP Connectors:** Insert one end of the DP cable into the computer's DP output and connect the other end to the monitor's DP port.
- 9 Power Connector:** Insert the power cable to supply power to the monitor.

5. Stand Installation

1. Open the package and take out the product with Styrofoam still attached. Gently place it on a table.



2. Remove the upper Styrofoam, then take the monitor out of the plastic bag and place it in the cavity of the lower cover of the Styrofoam.

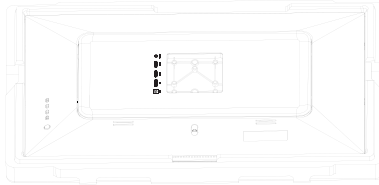

3. Take out the stand and the base. Use 2 KM4*12mm screws to fasten the stand and the base, as shown in the figure below.

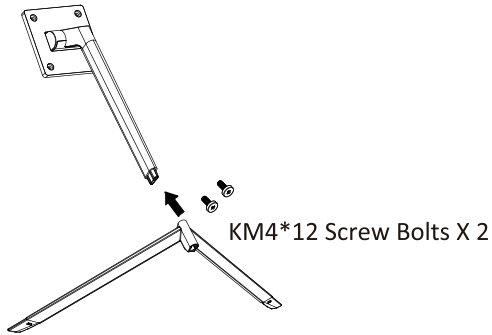

4. Put the assembled stand into the corresponding groove of the back of the monitor, and fasten it with four CM4*23mm screws, as shown in the figure below.

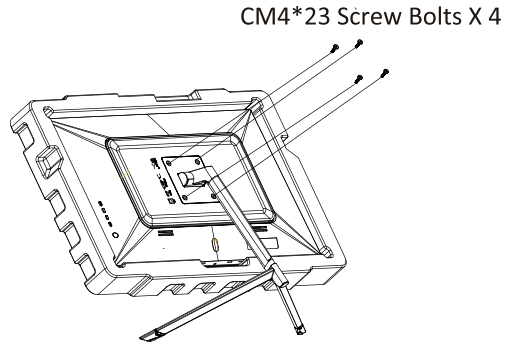

5. Take the bracket in your hand and stand the machine upright. (Note: during the process of erecting the machine, do not directly pinch the screen with your hands to prevent the screen from breaking.)

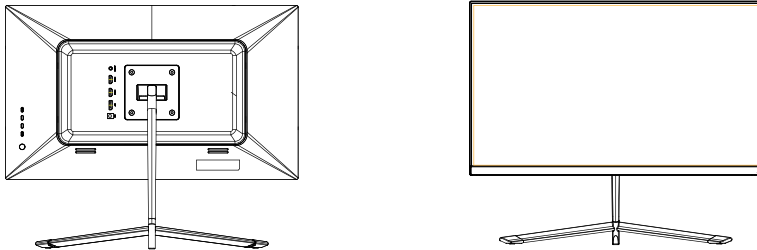

 Make sure the monitor is laid on a flat surface before removing the stand.

6. Wall Mounting



This monitor only includes screws which may be used when attaching the monitor to a VESA 75*75mm type mount. No VESA mount or mounting accessory is included.

1. Open the package and take out the product with Styrofoam still attached. Gently place it on a table. Remove the upper Styrofoam, then take the monitor out of the plastic bag and place it in the cavity of the lower cover of the Styrofoam.

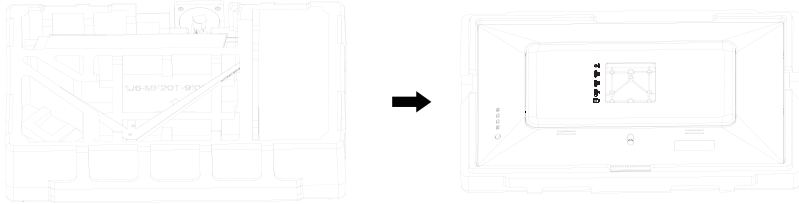

2. Take the four included M4 screws and install them in the M4 threaded hole on the back of the monitor. (During the installation of the screws, the monitor remains on the lower cover of the Styrofoam.)

M4*33mm Screw Bolts x 4

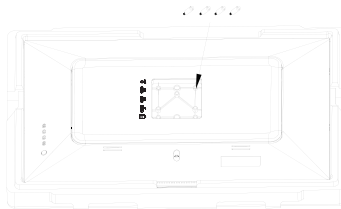

3. Install the monitor on the wall by following the instructions of your wall mount. (Note: Do not touch the panel during the mounting process to prevent it from breaking.)

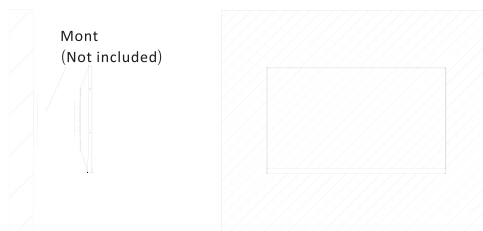

7. Indicator Light

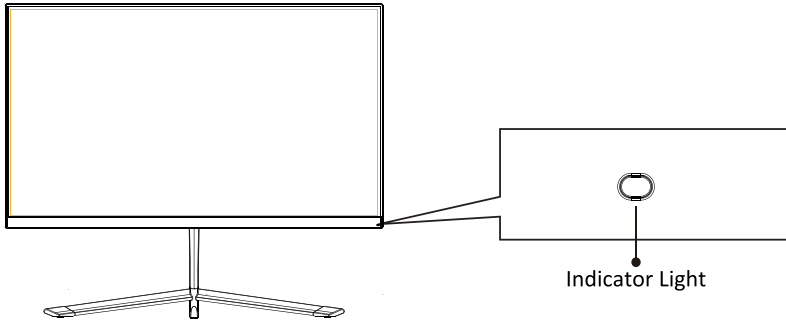

Consistent blue light indicates that the monitor is turned on and is operating normally. Flashing blue light indicates that no video source, no horizontal or vertical signal has been detected or power is low. Please make sure your computer is turned on and all cables are fully inserted and/or connected.

8. OSD Menu

The On-Screen Display (OSD) Menu may be used to adjust your monitor's settings and appears on screen after turning on the monitor and pressing the M button.

 When using the monitor for the first time, settings will automatically adjust to optimal settings according to your computer's configuration and parts etc.



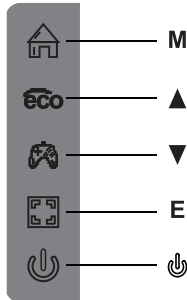

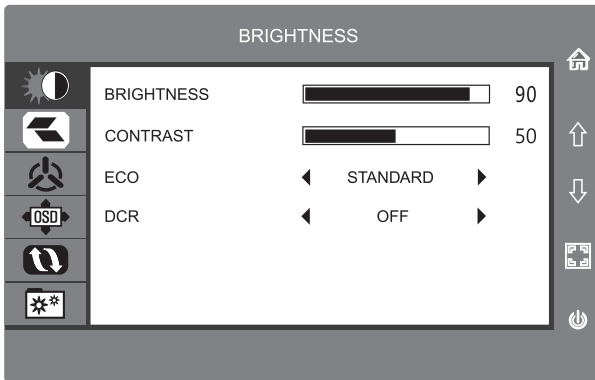

1. Press one of the buttons (M, ▲, ▼, E, ⏻) to activate the navigation window.



2. Press M() to enter the OSD screen.



3. Press  or  to browse functions.

- Highlight the desired function, then press  to enter the sub-menu.
- Press  or  to browse sub-menus, then press  to highlight the desired function.
- Press  or  to highlight an option, then press  to confirm the settings and exit the current screen.

4. Press  to exit the current screen.

8.1- OSD Menu Functions

Main Menu	Sub-Menu	Options	Description
BRIGHTNESS	Brightness	0~100	Adjust display brightness
	Contrast	0~100	Adjust display contrast
	ECO	Standard, Game, RTS, FPS, Movie, Text	Set visual mode
	DCR	On	Turn On DCR function
		Off	Turn Off DCR function
IMAGE	H. POSITION	0~100	Adjust horizontal position of the picture of source.
	V. POSITION	0~100	Adjust vertical position of the picture of source.
	Clock	0~100	Adjust picture clock to reduce the vertical line noise.
	PHASE	0~100	Adjust picture phase to reduce the level of noise.
	Aspect	Wide ,Auto ,4:3	Set aspect ratio
COLOR TEMP.	Color temp.	Warm, User , Cool	Adjust color temperature
	Red	0~100	Customize RGB components
	Green	0~100	
	Blue	0~100	
OSD SETTING	Language	English , Español , Русский , Français, 한국 , Português , Deutsch , Türkçe , 简体中文 , Polski , Italiano , Nederlands , 日本語	Set OSD language
	OSD H. POS.	0-100	Adjust the OSD horizontal position
	OSD V. POS.	0-100	Adjust the OSD vertical position
	OSD Timer	0~60	Set how long the OSD remains open after non-use
	Transparency	0-100	Set the OSD overall transparency

Main Menu	Sub-Menu	Options	Description
RESET	Reset	N/A	Reset monitor configurations
	IMAGE AUTO ADJUST	N/A	Auto adjust picture
	COLOR AUTO ADJUST	N/A	Auto adjust picture color
MISC	Signal source	HDMI 1, HDMI 2, DP	Display the input signal
	Volume	0-100	Adjust audio volume
	Low blue ray	0-100	Set blue light filtering level
	OVER DRIVER	Middle,Low,Off	Set the Overdriver function
	LED EFFECT	Off,Normal,Flicker	
	Adaptive Sync	On,Off	Turn the Adaptive Sync function on/off

9.ECO Modes and Gameplus Switching

1. Press one of the buttons(M, ▲, ▼, E, ʘ) to activate the navigation window.

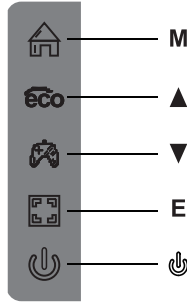

2. Press ▲ to switch ECO modes. These modes include Standard, Text, Movie, Game, FPS and RTS and modes and can be used to optimize settings according to your activity. Standard mode is suitable for most activities.



3. Press ▼ button to switch Gameplus modes. According to the needs of your game, choose the corresponding game icon. These game icons are primarily designed to optimize your target accuracy during shooting games, though they can be used for other scenarios.



10. Technical Specifications

Model	LC-M24-FHD-165
Screen Size	23.8"
Aspect Ratio	16:9
Backlight	LED
Brightness	250cd/m ²
Panel	IPS
Resolution	DP1.2: 1920*1080@165Hz HDMI 1.4: 1920*1080@120Hz
Refresh Rate	165Hz
Response Time	Fast 1ms
Viewing Angle	≥ 178°(H) / ≥ 178°(V)
Contrast Ratio	1000:1
VESA Mounting	75 x 75mm
Colours	16.7M
Adaptive Sync	Yes
Signal Input	DP 1.2*1, HDMI 1.4*2, AUDIO OUT*1
Audio	
Speakers	NO
Audio Out	Yes
Accessories	
Adapter	Yes
DisplayPort Cable	Yes
Additional Functions	
Low Blue Light	Yes
Physical Dimensions	
Dimensions (w/ Stand)	543.5*498.2*200mm
Dimensions (w/o Stand)	543.5*323.5*45.3mm
Net Weight	4.7kg
Gross Weight	6.66kg

TABLE DES MATIÈRES

1. Précautions relatives à la sécurité
2. Maintenance
3. Contenu de la boîte
4. Vue d'ensemble du produit
5. Installation du socle
6. Montage mural
7. Témoin lumineux
8. OSD
9. Commutation Modes ECO et Gameplus
10. Spécifications techniques

1. Précautions Relatives à La Sécurité

N'exposez pas le moniteur à un environnement humide, à la pluie ou à d'autres liquides.

Afin d'éviter tout choc dû à des risques électriques ou mécaniques, n'ouvrez pas le boîtier du moniteur.

Fonctionnement :

- Maintenez le moniteur à l'abri de la lumière directe du soleil ou d'autres sources de chaleur comme les convecteurs.
- Maintenez le moniteur éloigné de tout liquide.
- Retirez tout objet qui pourrait tomber dans les orifices de ventilation.
- Afin d'éviter toute surchauffe, n'obstruez pas les orifices de ventilation.
- Ne heurtez pas et ne laissez pas tomber le moniteur.

2. Maintenance

ATTENTION : Débranchez le cordon d'alimentation de la prise murale avant de nettoyer le moniteur,

- Pour nettoyer votre écran anti-statique, humidifiez légèrement un chiffon doux et propre avec de l'eau.
- Si possible, veuillez utiliser un chiffon spécial de nettoyage d'écran.
- N'utilisez pas de diluant, de benzène, d'ammoniac, de nettoyant abrasif ni d'air comprimé.
- Les solutions de nettoyage inappropriées peuvent endommager le moniteur ou laisser un film blanchâtre sur l'écran ou sur le boîtier.
- Débranchez le moniteur si vous ne prévoyez pas de l'utiliser pendant une période prolongée.
- N'exposez pas le moniteur à la poussière, aux liquides ou à un environnement humide.
- Si le moniteur entre en contact avec un liquide, essuyez-le immédiatement avec un chiffon sec.
- Si du liquide rejaillit sur les ouvertures de ventilation, cessez d'utiliser le moniteur. Veuillez contacter un technicien professionnel.

Rappel légal :



Les termes Interface Multimédia Haute Définition HDM1 et HDMI1, et le logo HDM1 sont des marques déposées par l'administrateur de licence d'HMD1, Inc. aux Etats-Unis et dans d'autres pays.

3. Contenu de La Boîte



Moniteur

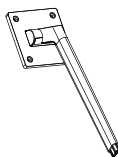

Support - Section verticale



Support - Base

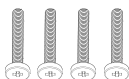

Boulon fileté CM4*23 x 4

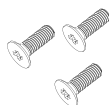

Boulon fileté KM3*14 x 2

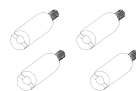

boulons à visser M4*33mm x 4
(Pour montage mural)



Câble DP

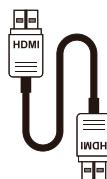

Câble HDMI



Tournevis x 1

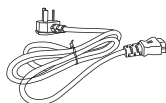

Câble d'alimentation x 1

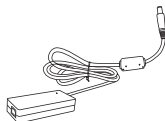

Adaptateur secteur x 1



Mode d'emploi



Des vis supplémentaires peuvent être fournies servant de vis de secours.

4. Description du Produit

4.1 — Boutons du Moniteur

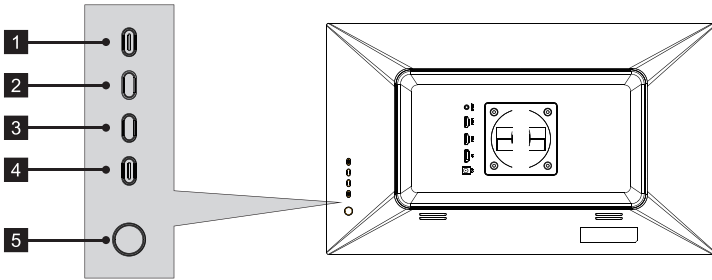

- 1 M Menu Button** :appuyez sur le bouton pour afficher le menu OSD ou accéder aux sous-menus.
- 2 ▲ Flèche du haut** :Appuyer pour monter dans les menus.
- 3 ▼ Flèche du bas** :Appuyer pour descendre dans les menus.
- 4 Bouton de sortie E** :Appuyez pour quitter.
- 5 ⏻ Bouton d'alimentation** :Appuyez pour allumer ou éteindre le moniteur.

4.2 — Ports du Moniteur

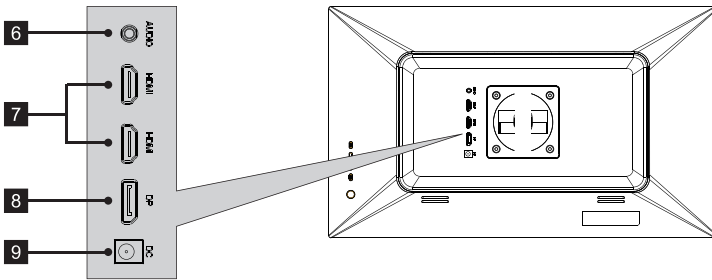

- 6 Sortie audio**Insérez : le câble audio pour obtenir des signaux audio de sortie.
- 7 Connecteurs HDMI** : Insérez une extrémité du câble HDMI dans la sortie HDMI de l'ordinateur puis branchez l'autre extrémité du câble dans le port HDMI du moniteur.
- 8 Connecteurs DP** : Insérez une extrémité du câble DP dans la sortie DP de l'ordinateur puis branchez l'autre extrémité du câble dans le port DP du moniteur.
- 9 Connecteur d'alimentation** :Insérez le câble d'alimentation pour alimenter le moniteur.

5. Installation du Socle

1. Ouvrez l'emballage en carton, retirez les couvercles supérieur et inférieur de Poly Dragon et posez-le à plat sur le bureau.



2. Une fois que vous avez ouvert la boîte d'emballage, retirez le couvercle supérieur de Poly Dragon, puis sortez le corps du sac de film et placez-le dans la cavité du couvercle inférieur de Poly Dragon.



3. Retirez le support et la base, et utilisez 2 vis KM4 * 12mm pour passer à travers la base puis verrouillez le support, comme indiqué sur le schéma ci-dessus.

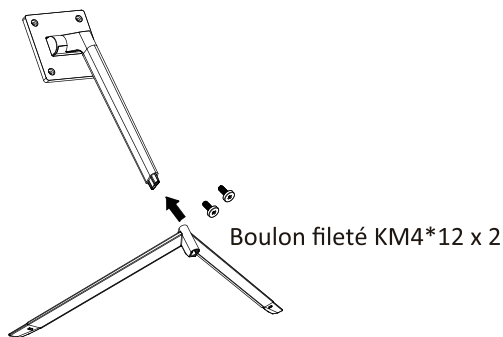

4. Comme le montre le schéma ci-dessous, placez l'ensemble de base assemblé à l'étape 3 dans la rainure fraisée correspondante de la coque arrière puis verrouillez-le à l'aide de quatre vis à tête plate CM4 * 23 mm. Pour effectuer un démontage, suivez les étapes inverses.

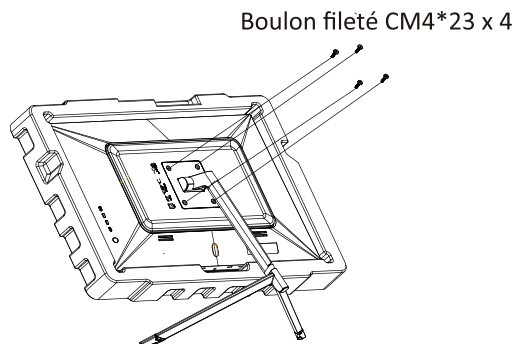

5. Saisissez simplement le support avec votre main et relevez la machine. (Remarque : au cours du processus de montage de la machine, ne pincez pas directement l'écran avec les mains afin d'éviter que l'écran ne se brise)

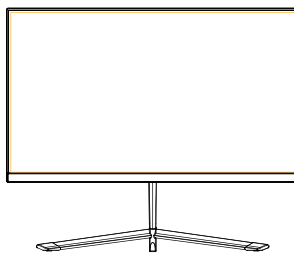
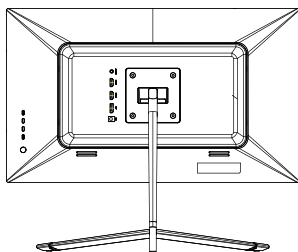

-  Assurez-vous que le moniteur est posé sur une surface plane avant de retirer le socle.

6. Montage Mural



Ce moniteur comprend uniquement les vis qui peuvent être nécessaires lors de la fixation de celui-ci à un support de type VESA 75*75 mm. Aucun support ou accessoire de fixation VESA n'est inclus.

1. Ouvrez la boîte d'emballage, retirez l'emballage intérieur et posez-le à plat sur le bureau.
Retirez le couvercle supérieur en polystyrène, sortez le sac pelliculé du fuselage et remettez le fuselage dans la mousse de polystyrène inférieure d'origine.

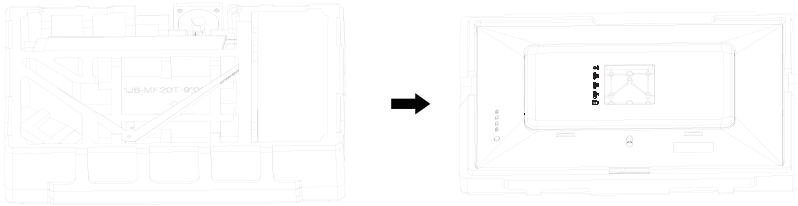

2. Trouvez le goujon en fer rond avec une hauteur de colonne de 25 mm de l'accessoire et verrouillez-le dans le trou fileté M4 de la coque arrière comme montré sur le schéma ci-dessus. Utilisez un tournevis à tête plate pour le verrouiller.
(Assemblez et démontez les vis, l'écran d'affichage ne doit pas quitter la mousse Polylong afin d'éviter de briser l'écran)

Boulon fileté M4*33 x 4

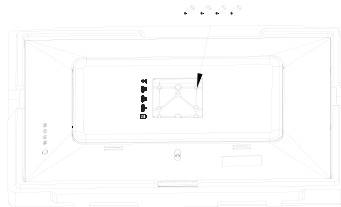

3. Ne pincez pas directement l'écran avec vos mains pour suspendre le produit afin d'éviter de l'endommager.

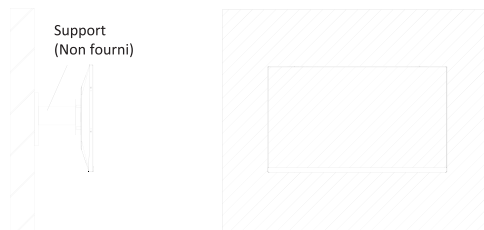

7. Témoin lumineux

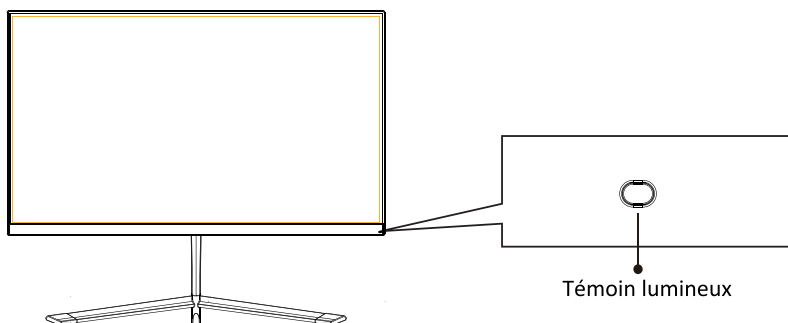

Le voyant bleu fixe indique que l'appareil est sous tension et que le moniteur fonctionne normalement.

Le témoin bleu clignotant indique qu'il n'y a pas de source vidéo, qu'aucun signal horizontal ou vertical n'a été détecté, ou bien que l'alimentation est faible. Veuillez vous assurer que votre ordinateur est allumé et que tous les câbles vidéo sont complètement insérés et/ou connectés.

8. OSD

Le menu d'affichage à l'écran (OSD) peut être utilisé pour régler les paramètres de votre moniteur et apparaît à l'écran après avoir allumé le moniteur et appuyé sur le bouton M.



Lorsque vous utilisez le moniteur pour la première fois, les paramètres se règlent automatiquement sur les valeurs optimales en fonction de la configuration et des composants de votre ordinateur, etc.

1. Appuyez sur l'un des boutons (M, ▲, ▼, E, ⏻) pour activer la fenêtre de navigation

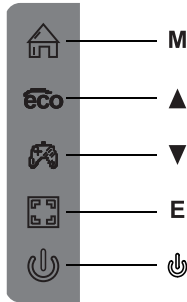

2. Appuyez sur M (🏠) pour entrer dans l'écran OSD.

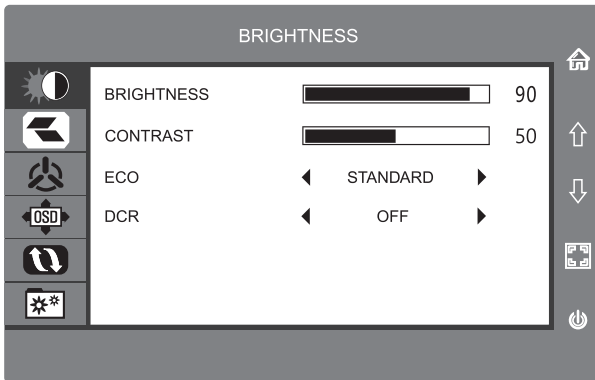

3. Appuyez sur ↑ ou ↓ pour naviguer dans les fonctions.
 - Mettez en surbrillance la fonction souhaitée, puis appuyez sur 🏠 pour accéder au sous-menu.
 - Appuyez sur ↑ ou ↓ pour naviguer dans les sous-menus, puis appuyez sur 🏠 pour mettre en surbrillance la fonction désirée.
 - Appuyez sur ↑ ou ↓ pour mettre en surbrillance une option, puis appuyez sur 🏠 pour confirmer le paramètre et quitter l'écran courant.
4. Appuyez sur 🗄️ pour quitter l'écran courant.

8.1 – Fonctions du Menu OSD

Menu principal	Sous-menu	Options	Description
Luminosité	Luminosité	0~100	Régler la luminosité de l'écran
	Contraste	0~100	Régler le contraste de l'écran
	ECO	Standard, Jeu, RTS, FPS, Film, Texte	Régler le mode visuel
	DCR	Activé	Activer la fonction DCR
		Désactivé	Désactiver la fonction DCR
IMAGE	Position H	0~100	Ajustez la position horizontale de l'image de la source.
	Position V	0~100	Ajustez la position verticale de l'image de la source.
	Horloge	0~100	Réglez l'horloge de l'image afin de réduire le bruit de la ligne verticale.
	PHASE	0~100	Réglez la phase de l'image afin de réduire le niveau de bruit.
	Aspect	Large, Auto, 4:3	Réglez le format d'image
Température de couleur	Température de couleur	Chaude Utilisateur, Froide	Ajuster la température de couleur
	Rouge	0~100	Personnaliser les composants RVB
	Vert(e)	0~100	
	Bleu(e)	0~100	
RÉGLAGE OSD	Langue	English , Español , Русский, Français, 한국, Português, Deutsch, Türkçe, 简体中文, Polski, Italiano, Nederlands, 日本語	Régler la langue de l'OSD
	POS. OSD H.	0~100	Régler la position horizontale OSD
	POS. OSD V.	0~100	Régler la position verticale de l'OSD
	Minuteur OSD	0~60	Régler la durée pendant laquelle l'OSD reste ouvert en l'absence d'activité
	Transparence	0~100	Régler la transparence globale de OSD

Menu principal	Sous-menu	Options	Description
Réinitialiser	Réinitialiser	S/O	Réinitialiser les configuration du moniteur
	IMAGE AUTO RÉGLAGE	S/O	Réglage automatique de l'image
	COULEUR AUTO RÉGLAGE	S/O	Réglage automatique de la couleur de l'image
DIVERS	Source du signal	HDMI 1, HDMI 2, DP	Affichage du signal d'entrée
	Volume	0-100	Régler le volume audio
	Faible lumière bleue	0-100	Régler le niveau de filtrage de la lumière bleue
	OVER DRIVER	Moyen/Moyenne, Faible, Désactivé(e)	Régler la fonction de Overdriver
	Effets LED	Désactivé, Normal, Clignotement	
	Synchronisation adaptative	Activé, Désactivé	Activer/ Désactiver la fonction de Synchronisation adaptative

9. Commutation Modes ECO et Gameplus

1. Appuyez sur l'un des boutons (M, ▲, ▼, E, ⏻) pour activer la fenêtre de navigation

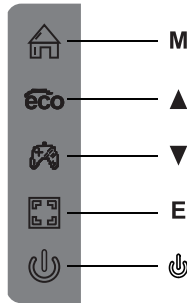

2. Appuyez sur le ▲ pour basculer entre les ECO. Ces modes incluent les modes Standard, Texte, Film, Jeu, FPS et RTS et peuvent être utilisés pour optimiser les paramètres en fonction de votre activité. Le mode standard convient à la plupart des activités.



3. Appuyez sur le bouton ▼ pour commuter entre les modes GamePlus. En fonction des besoins de votre jeu, choisissez l'icône de jeu correspondant. Ces icônes de jeu sont conçus pour optimiser votre visée pendant les jeux de tir, bien qu'ils puissent être utilisés dans d'autres scénarios.



10. Spécifications Techniques

Modèle	LC-M24-FHD-165
Taille d'écran	23,8 pouces
Format d'image	16:9
Rétroéclairage	LED
Luminosité	250 cd / m ²
Panneau	IPS
Résolution	DP1.2 :1920 * 1080 à 165Hz HDMI 1.4 :1920 * 1080 à 120Hz
Taux de rafraîchissement	165 Hz
Temps de réponse	Rapide 1ms
Angles de vue	≥ 178° (H) / ≥ 178° (V)
Taux de contraste	1000:1
Montage VESA	75 x 75 mm
Couleurs	16,7 M
Synchronisation adaptative	Oui
Entrée de signal	DP 1,2 * 1, HDMI 1,4 * 2, SORTIE AUDIO * 1
Audio	
Haut-parleurs	NON
Sortie Audio	Oui
Accessoires	
Adaptateur	Oui
Câble DisplayPort	Oui
Fonctions supplémentaires	
Faible lumière bleue	Oui
Dimensions physiques	
Dimensions (avec socle)	543,5 * 498,2 * 200mm
Dimensions (sans socle)	543,5 * 323,5 * 45,3mm
Poids net	4,7 kg
Poids brut	6,66 kg

TABLA DE CONTENIDO

1. Precauciones de seguridad
2. Maintenance
3. Contenido de la caja
4. Información general del producto
5. Instalación del pedestal
6. Instalación en pared
7. Indicador luminoso
8. Menús OSD
9. Cambio a los modos ECO y Gameplus
10. Especificaciones Técnicas

1. PRECAUCIONES DE SEGURIDAD

No exponga el monitor a un entorno húmedo, a la lluvia ni a otros líquidos. Para evitar descargas eléctricas debidas a riesgos eléctricos o mecánicos, no abra la carcasa del monitor.

Funcionamiento:

- Mantenga el monitor alejado de la luz solar directa u otras fuentes de calor como puede ser una estufa.
- Mantenga el monitor alejado de cualquier líquido.
- Retire cualquier objeto que pueda caer en los orificios de ventilación.
- Para evitar el sobrecalentamiento, no bloquee los orificios de ventilación.
- No golpee ni deje caer el monitor.

2. MAINTENANCE

PRECAUCIÓN: Desenchufe el cable de alimentación de la toma de corriente antes de limpiar el monitor.

- Para limpiar la pantalla, humedezca ligeramente un paño suave y limpio con agua.
- Si es posible, utilice una toallita especial para limpiar pantallas.
- No utilice benceno, diluyentes, amoníaco, limpiadores abrasivos o aire comprimido.
- Las soluciones de limpieza inadecuadas pueden dañar el monitor o dejar una película lechosa en la pantalla o la carcasa.
- Desenchufe el monitor si no la va a utilizar durante un prolongado período de tiempo.
- No exponga el monitor al polvo, a líquidos o a un entorno húmedo.
- En caso de que el monitor entre en contacto con líquidos, límpielo inmediatamente con un paño seco.
- Si se derrama líquido en los orificios de ventilación, no use más el monitor. Póngase en contacto con un técnico de servicio profesional.

Aviso legal:



Los términos HDMI, HDMI High-Definition Multimedia Interface y el logotipo de HDMI son marcas comerciales o marcas registradas de HDMI Licensing, Administrator, Inc. en EE. UU. y otros países.

3. Contenido De La Caja



Monitor

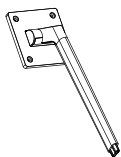

Pedestal: sección vertical



Pedestal: base

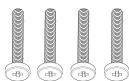

Tornillos CM4*23 X4

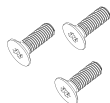

Tornillos KM3*14 X3

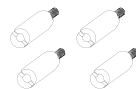

Tornillos M4*33 mm X 4
(para la instalación en pared)



Cable DP

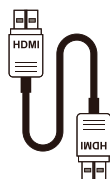

Cable HDMI



Destornillador x 1

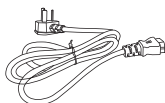

Cable de alimentación x 1

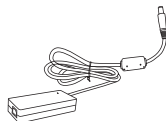

Adaptador de alimentación X 1



Manual del usuario



Se pueden incluir tornillos adicionales de repuesto.

Español-2

4. Información General Del Producto

4.1—Botones Del Monitor

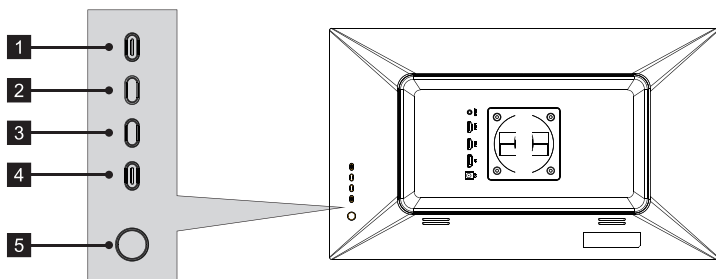

- 1 M Botón Menú:** presione este botón para mostrar los menús OSD o introducir los submenús.
- 2 ▲ Botón Arriba:** presione este botón para desplazarse hacia arriba por los menús.
- 3 ▼ Botón Abajo:** presione este botón para desplazarse hacia abajo por los menús.
- 4 E Botón Salir:** Presione este botón para salir.
- 5 ⏻ Botón de alimentación:** Presione este botón para encender o apagar el monitor.

4.2—Puertos del monitor

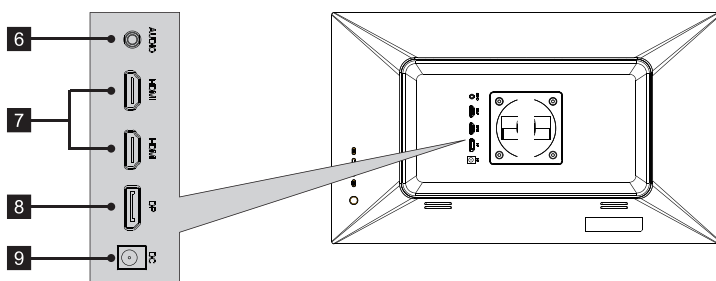

- 6 Salida de audio:** inserte el cable de audio para la salida de señales de audio.
- 7 Conectores HDMI:** inserte un extremo del cable HDMI en la salida HDMI de su PC y conecte el otro extremo al puerto HDMI del monitor.
- 8 Conectores DP:** inserte un extremo del cable DP en la salida DP de su PC y conecte el otro extremo al puerto DP del monitor.
- 9 Conector de alimentación:** inserte el cable de alimentación para proporcionar energía al monitor.

5. Instalación Del Pedestal

1. Abra el paquete de cartón, saque las cubiertas superior e inferior de Poly Dragon y colóquelas sobre el escritorio.

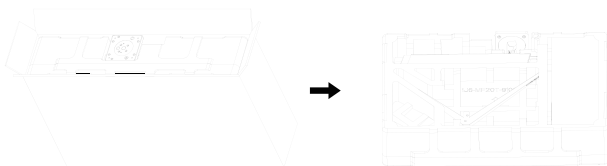

2. Después de abrir la caja de embalaje, retire la cubierta superior de Poly Dragon; a continuación, saque el cuerpo de la bolsa de película y colóquelo en la cavidad de la cubierta inferior de Poly Dragon.

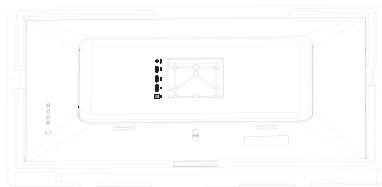

3. Saque el soporte y la base, y use 2 tornillos KM4*12 mm para atravesar la base y bloquear el soporte, como se muestra en la figura anterior.

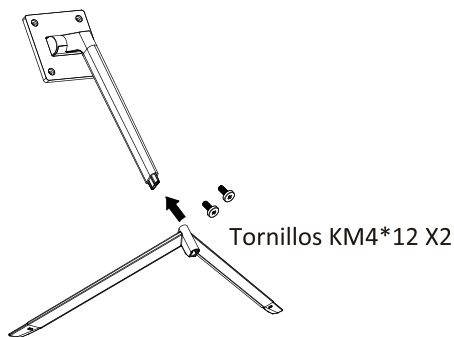

4. Como se muestra en la figura siguiente, coloque el conjunto de la base ensamblado en el paso 3 en la ranura avellanada correspondiente de la carcasa trasera y bloquéelo con cuatro tornillos de cabeza plana CM4*23 mm. Para realizar el desmontaje, siga los mismos pasos en orden inverso.

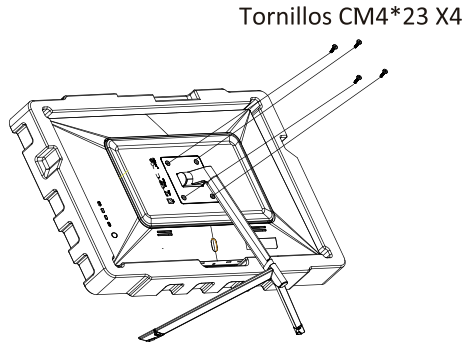

5. Simplemente agarre el soporte con la mano y levante la máquina. (Nota: Durante el proceso de elevación de la máquina, no agarre directamente la pantalla con las manos para evitar que se rompa)

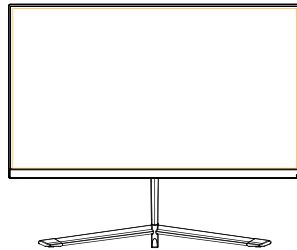
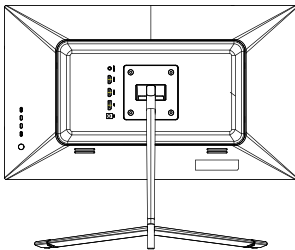

-  Asegúrese de colocar el monitor sobre una superficie plana antes de quitar el pedestal.

6. Instalación En Pared



Este monitor solo incluye tornillos que pueden usarse al conectar el monitor a un soporte tipo VESA de 75*75 mm. No se incluye un soporte VESA ni un accesorio de montaje.

1. Abra la caja de embalaje, saque el paquete del interior y colóquelo sobre el escritorio.

Retire la cubierta superior de espuma de poliestireno, saque la bolsa recubierta con película del fuselaje y vuelva a colocar este en la espuma de poliestireno inferior original.

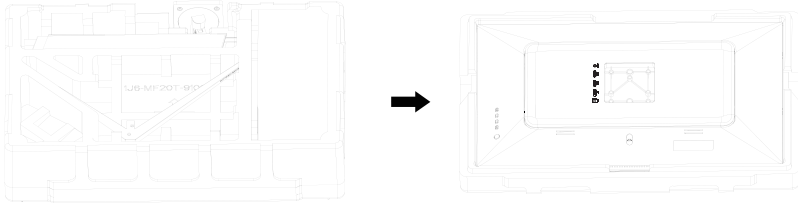

2. Localice el perno de hierro redondo con una altura de columna de 25 mm desde el accesorio y bloquéelo en el orificio roscado M4 de la carcasa trasera como se muestra en la figura anterior. Utilice un destornillador de punta plana para bloquearlo.
(Cuando coloque y quite los tornillos, la pantalla de visualización debe seguir manteniendo la espuma Polylong para evitar que dicha pantalla se rompa)

Tornillos M4*33 X4

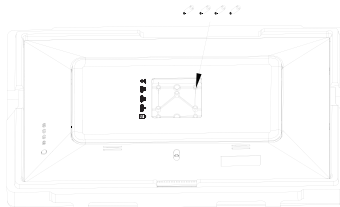

3. Para evitar que el producto se rompa, no pellizque la pantalla directamente con las manos cuando cuelgue dicho producto.



7. Indicador Luminoso

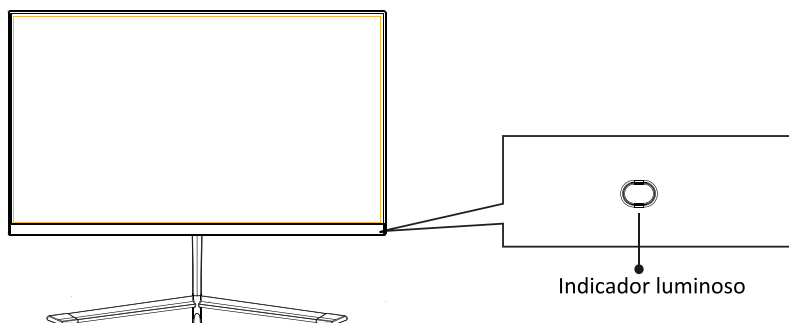

La luz azul fija indica que la alimentación está activada y que el monitor está funcionando con normalidad.

La luz azul intermitente indica que no se ha detectado ninguna señal horizontal o vertical o que la potencia es baja. Asegúrese de que el equipo esté encendido y que todos los cables de vídeo estén completamente insertados o conectados.

8. Menú OSD

El menú de visualización en pantalla (OSD) se puede usar para ajustar la configuración del monitor y aparece en la pantalla después de encender el monitor y presionar el botón M.

 Cuando use el monitor por primera vez, la configuración se ajustará automáticamente a la configuración óptima de acuerdo con la configuración y las partes de su PC, etc.

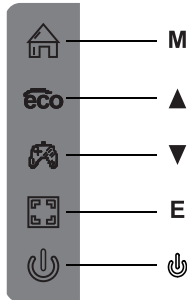

1. Presione uno de los botones (M, ▲, ▼, E, ⏻) para activar la ventana de navegación.

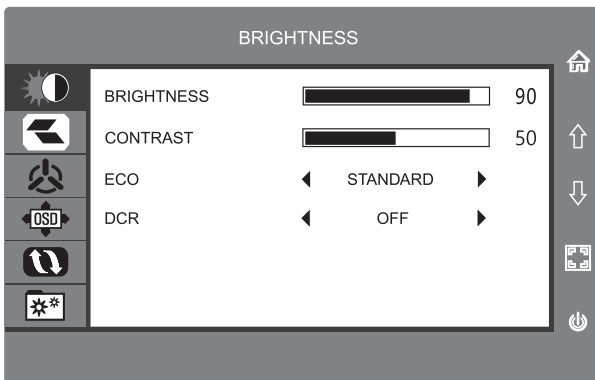

2. Presione M () para entrar en la pantalla OSD.



3. Presione ↑ o ↓ para navegar por las funciones.

- Resalte la función que desee y, a continuación, presione  para entrar en el submenú.
- Presione ↑ o ↓ para navegar por los submenús y, a continuación, presione  para resaltar la función deseada.
- Presione ↑ o ↓ para resaltar una opción y, a continuación, presione  para confirmar la configuración y salir de la pantalla actual.

4. Presione  para salir de la pantalla actual.

8.1—Funciones De Los Menús OSD

Menú principal	Submenú	Opciones	Descripción
BRILLO	Brillo	0~100	Permite ajustar el brillo de la pantalla
	Contraste	0~100	Permite ajustar el contraste de la pantalla
	ECO	Estándar, Juego, RTS, FPS, Película, Texto	Establecer el modo visual
	DCR	Activado	Permite activar la función DCR
		Desactivado	Permite desactivar la función DCR
IMAGEN	Posición H	0~100	Permite ajustar la posición horizontal de la imagen de origen.
	Posición V	0~100	Permite ajustar la posición vertical de la imagen de origen.
	Reloj	0~100	Permite ajustar el reloj de imagen para reducir el ruido de línea vertical.
	FASE	0~100	Permite ajustar la fase de la imagen para reducir el nivel de ruido.
	Aspecto	Panorámica, Automático, 4:3	Permite establecer relación de aspecto
Temperatura de color	Temperatura de color	Cálida, Usuario, Fría	Ajuste la temperatura de color
	Rojo	0~100	Permite personalizar componentes RGB
	Verde	0~100	
	Azul	0~100	
CONFIGURACIÓN OSD	Idioma	English , Español , Русский , Français , 한국 , Português , Deutsch , Türkçe , 简体中文 , Polski , Italiano , Nederlands , 日本語	Permite establecer el idioma de los menús OSD
	POS. H. OSD	0~100	Permite ajustar la posición horizontal de los menús OSD
	POS. V. OSD	0~100	Permite ajustar la posición vertical de los menús OSD
	Temporizador de OSD	0~60	Permite establecer cuánto tiempo permanecerán abiertos los menús OSD después de que haya dejado de utilizarse
	Transparencia	0~100	Permite establecer la transparencia global de los menús OSD

Menú principal	Submenú	Opciones	Descripción
Restablecer	Restablecer	N/D	Permite restablecer las configuraciones del monitor
	AJUSTE AUTOMÁTICO DE LA IMAGEN	N/D	Ajuste automático de la imagen
	AJUSTE AUTOMÁTICO DEL COLOR	N/D	Ajuste automático del color de la imagen
VARIOS	Fuente de señal	HDMI 1, HDMI 2, DP	Permite mostrar la señal de entrada
	Volumen	0-100	Permite ajustar el volumen de audio
	Rayo azul bajo	0-100	Permite establecer nivel de filtrado de luz azul
	SOBRECONTROLADOR	Medio, Bajo, Desactivado	Permite establecer la función Sobrecontrolador.
	Efectos de LED	Desactivado, Normal, Parpadeo	
	Sincronización adaptativa	Activado, Desactivado	Permite activar y desactivar la función Sincronización adaptativa

9. Cambio a Los Modos Eco y Gameplus

1. Presione uno de los botones (M, ▲, ▼, E, ʘ) para activar la ventana de navegación.

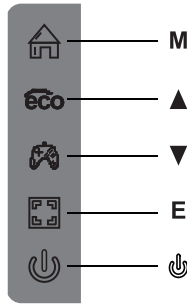

2. Presione el ▲ para cambiar los modos ECO. Estos modos incluyen Estándar, Texto, Película, Juego, FPS y RTS, y se pueden utilizar para optimizar la configuración de acuerdo con su actividad. El modo estándar es adecuado para la mayoría de las actividades.



3. Presione el botón ▼ para cambiar al modo Gameplus. Según las necesidades del juego, elija el ícono del juego correspondiente. Estos íconos de juego están diseñados principalmente para optimizar su puntería durante los juegos de disparos, aunque se pueden usar para otros escenarios.



10. Especificaciones Técnicas

Modelo	LC-M24-FHD-165
Tamaño de la pantalla	23,8"
Relación de aspecto	16:9
Luz de fondo	LED
Brillo	250 cd/m ²
Panel	IPS
Resolución	DP1.2: 1920*1080 a 165Hz HDMI 1.4: 1920*1080 a 120Hz
Tasa de actualización	165Hz
Tiempo de respuesta	Rápido 1 ms
Ángulo de visión	≥ 178° (H) / ≥ 178° (V)
Relación de contraste	1000:1
Soprote VESA	75 x 75 mm
Colores	16,7M
Sincronización adaptativa	Sí
Señal de entrada	DP 1.2*1, HDMI 1.4*2, SALIDA DE AUDIO*1
Audio	
Altavoces	NO
Salida de audio	Sí
Accesorios	
Adaptador	Sí
Cable DisplayPort	Sí
Funciones adicionales	
Luz Azul baja	Sí
Dimensiones físicas	
Dimensiones (con base)	543,5*498,2*200 mm
Dimensiones (sin base)	543,5*323,5*45,3 mm
Peso neto	4,7kg
Peso bruto	6,66kg

INDICE

1. Precauzioni sulla sicurezza
2. Maintenance
3. Contenuto della confezione
4. Descrizione del prodotto
5. Installazione del supporto
6. Montaggio a parete
7. Indicatore
8. OSD
9. Commutazione modalità ECO e Gameplus
10. Specifiche tecniche

1. PRECAUZIONI SULLA SICUREZZA

Non esporre il monitor a un ambiente umido, pioggia o altri liquidi.
Non aprire l'alloggiamento del monitor per evitare scosse dovute a rischi elettrici o meccanici.

Funzionamento:

- Tenere il monitor lontano dalla luce solare diretta o da altre fonti di calore come stufe.
- Tenere il monitor lontano da qualsiasi liquido.
- Rimuovere eventuali oggetti che potrebbero cadere nei fori di ventilazione.
- Non ostruire i fori di ventilazione per evitare il surriscaldamento.
- Non far subir urti né far cadere il monitor.

2. MAINTENANCE

ATTENZIONE: Scollegare il cavo di alimentazione dalla presa prima di pulire il monitor.

- Per pulire lo schermo, inumidire leggermente un panno morbido e pulito.
- Utilizzare uno speciale panno per la pulizia dello schermo, se possibile.
- Non utilizzare benzene, solventi, ammoniaca, detersivi abrasivi o aria compressa.
- Le soluzioni di pulizia inadeguate potrebbero danneggiare il monitor o lasciare una pellicola lattiginosa sullo schermo o sull'alloggiamento.
- Scollegare il monitor se non lo si utilizza per un periodo di tempo più lungo.
- Non esporre il monitor a polvere, liquidi o ambienti umidi.
- Se il monitor viene a contatto con qualsiasi liquido, pulirlo immediatamente con un panno asciutto.
- In caso di versamento di liquido nei fori di ventilazione, non utilizzare più il monitor. Contattare un tecnico di assistenza professionale.

Avviso legale:



I termini HDMI, HDMI High-Definition Multimedia Interface e il logo HDMI sono marchi di fabbrica o marchi registrati di HDMI Licensing Administrator, Inc. negli Stati Uniti e in altri Paesi.

3. Contenuto Della Confezione



Monitor

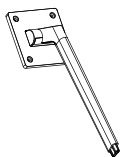

Supporto - Sezione verticale



Supporto - Base

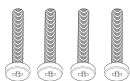

Viti CM4*23 x 4

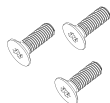

Viti KM3*14 x 3

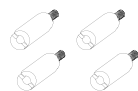

Viti M4*33mm x 4
(Per montaggio a parete)



Cavo DP

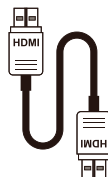

Cavo HDMI



Cacciavite x 1

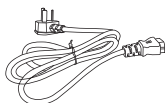

Cavo di alimentazione x 1

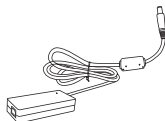

Adattatore di alimentazione x 1



MANUALE UTENTE



Potrebbero essere incluse viti extra di ricambio.

4. Descrizione Del Prodotto

4.1 — Tasti Del Monitor

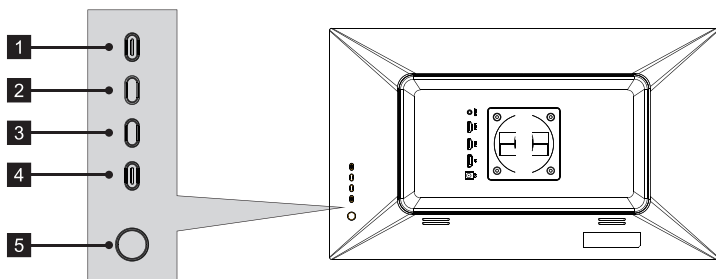

- 1 Tasto M Menu:** Premere per visualizzare il menu OSD o accedere ai menu secondari.
- 2 ▲ Tasto Su:** premere per spostarsi verso l'alto nei menu.
- 3 ▼ Tasto Giù:** premere per spostarsi verso il basso nei menu.
- 4 Tasto E:** Esci Premere per uscire.
- 5 Tasto alimentazione:** Premere per accendere/spegnere il monitor.

4.2 — Porte Del Monitor

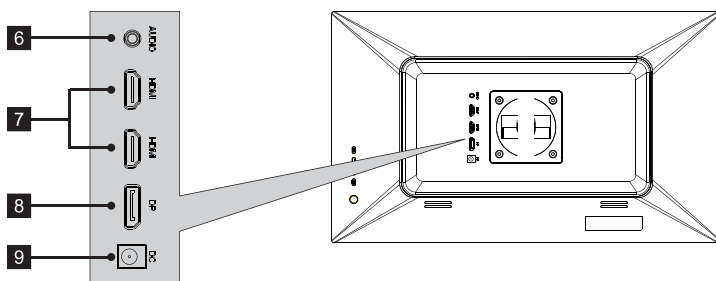

- 6 Uscita audio:** Inserire il cavo audio per l'uscita dei segnali audio.
- 7 Connettore HDMI:** Inserire un'estremità del cavo HDMI nell'uscita HDMI del computer e collegare l'altra estremità alla porta HDMI del monitor.
- 8 Connettori DP:** Inserire un'estremità del cavo DP nell'uscita DP del computer e collegare l'altra estremità alla porta DP del monitor.
- 9 Connettore di alimentazione:** Inserire il cavo di alimentazione nell'alimentatore del monitor.

5. Installazione Del Supporto

1. Aprire la confezione di cartone, estrarre i coperchi superiore e inferiore di Poly Dragon e appoggiarlo sulla scrivania.

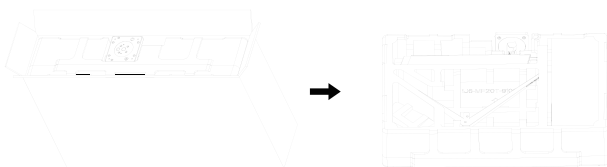

2. Dopo aver aperto la confezione, rimuovere il coperchio superiore di Poly Dragon, quindi estrarre il corpo dalla busta rivestita con pellicola e posizionarlo nella cavità del coperchio inferiore di Poly Dragon.

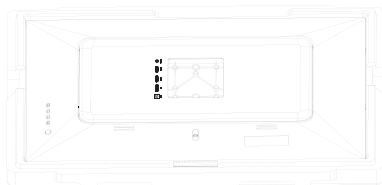

3. Estrarre la staffa e la base e utilizzare 2 viti KM4*12 mm per passare attraverso la base e bloccare la staffa, come mostrato nella figura precedente.

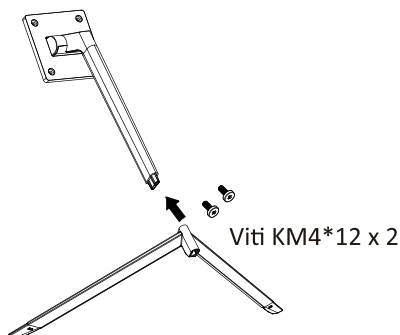

4. Come mostrato nella figura di seguito, inserire il gruppo base assemblato nel passaggio 3 nella corrispondente scanalatura svasata della struttura posteriore e bloccarlo con quattro viti a testa piatta CM4*23 mm. Durante lo smontaggio, seguire i passaggi inversi.

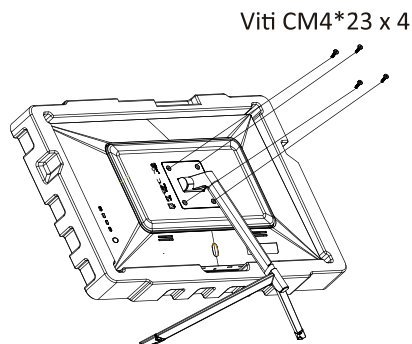

5. Basta afferrare la staffa con la mano e sollevare la macchina.
(nota: durante il processo di montaggio della macchina, non avvicinare le dita sullo schermo direttamente per evitare che lo schermo si rompa)

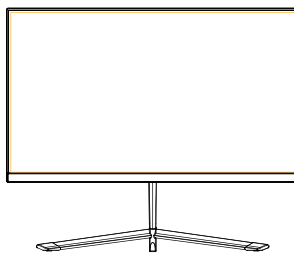
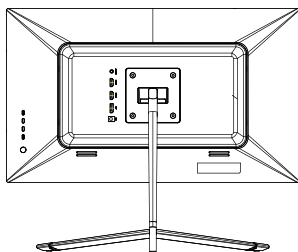

-  Assicurarsi che il monitor sia posizionato su una superficie piana prima di rimuovere il supporto.

6. Montaggio a Parete



Questo monitor include solo viti che possono essere utilizzate quando si collega il monitor a un supporto di tipo VESA 75*75 mm. Non sono inclusi accessori per montaggio o supporto VESA.

1. Aprire la confezione, estrarre l'imballaggio interno e appoggiarlo sulla scrivania.
Rimuovere il coperchio di polistirolo superiore, estrarre la busta rivestita con pellicola della fusoliera e inserire di nuovo la fusoliera nel polistirolo inferiore originale.

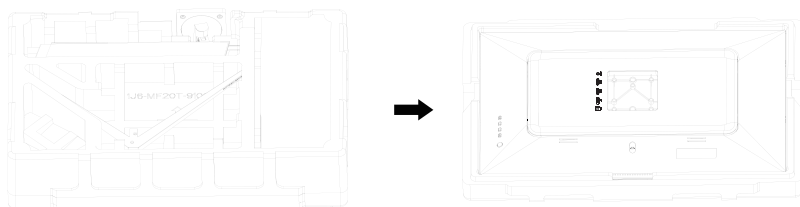

2. Trovare il perno di ferro rotondo con un'altezza della colonna di 25 mm dall'attacco e bloccalo nel foro filettato M4 della struttura posteriore come mostrato nella figura precedente. Usare un cacciavite a testa piatta per bloccarlo.
(Montare e smontare le viti. Non è possibile estrarre lo schermo del display dal polistirolo Polylong per evitare che si rompa)

Viti M4*33 x 4

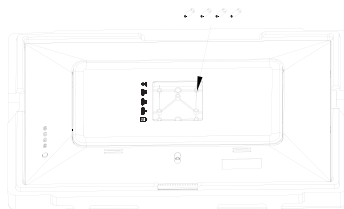

3. Non avvicinare le dita sullo schermo direttamente durante il processo di sospensione del prodotto per evitare che lo schermo si rompa.

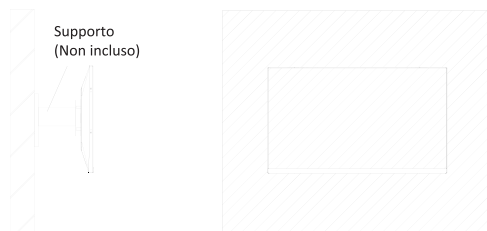

7. Indicatore

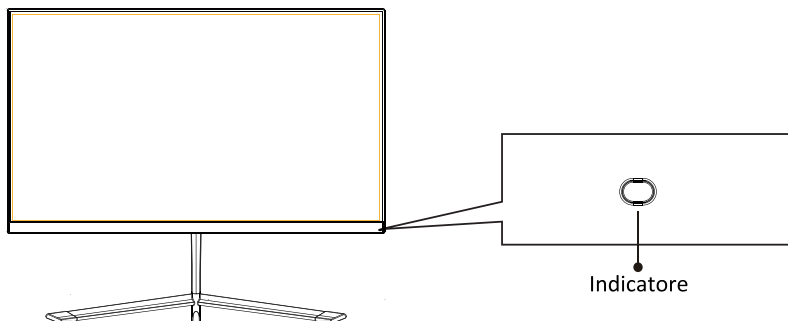

La spia blu fissa indica che l'alimentazione è accesa e il monitor funziona normalmente.

La spia blu lampeggiante indica che non è presente alcuna sorgente video, non è stato rilevato alcun segnale orizzontale o verticale o che la potenza è bassa. Assicurarsi che il computer sia acceso e che tutti i cavi video siano inseriti e/o collegati completamente.

8. OSD

Il menu OSD (On-Screen Display) può essere utilizzato per regolare le impostazioni del monitor e appare sullo schermo dopo aver acceso il monitor e premuto il tasto M.

 Quando si utilizza il monitor per la prima volta, le impostazioni si adattano automaticamente alle impostazioni ottimali in base alla configurazione e alle parti del computer, ecc.

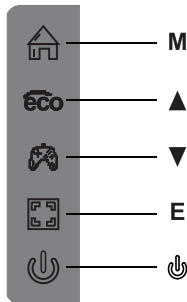

1. Premere uno dei tasti (**M**, **▲**, **▼**, **E**, **⏻**) per attivare la finestra di navigazione.

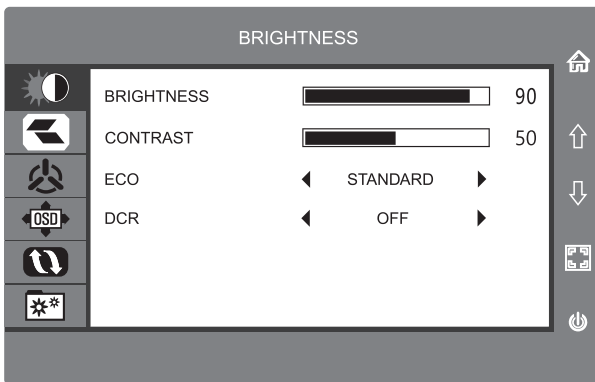

2. Premere **M** () per accedere alla schermata OSD.



3. Premere **↑** o **↓** per passare tra le funzioni.

- Evidenziare la funzione desiderata, quindi premere  per accedere al sottomenu.
- Premere **↑** o **↓** per passare tra i menu secondari, quindi premere  per evidenziare la funzione desiderata.
- Premere **↑** o **↓** per evidenziare un'opzione, quindi premere  per confermare le impostazioni e uscire dalla schermata attuale.

4. Premere  per uscire dalla schermata attuale.

8.1 – Funzioni del menu OSD

Menu principale	Menu secondario	Opzioni	Descrizione
LUMINOSITÀ	Luminosità	0~100	Regola la luminosità del display
	Contrasto	0~100	Regola il contrasto del display
	ECO	Standard, Gioco, RTS, FPS, Film, Testo	Imposta modalità visiva
	DCR	Attiva	Attiva la funzione DCR
		Disattiva	Disattiva la funzione DCR
IMMAGINE	Posizione O	0~100	Regola la posizione orizzontale dell'immagine della sorgente.
	POSIZIONE V.	0~100	Regola la posizione verticale dell'immagine della sorgente.
	Clock	0~100	Regola il clock immagine per ridurre il disturbo delle linee verticali.
	FASE	0~100	Regola la fase immagine per ridurre il disturbo delle linee orizzontali.
	Proporzioni	Wide, Auto, 4:3	Imposta le proporzioni
Temp. colore	Temp. colore	Caldo, Utente, Freddo	Regola la temperatura colore
	Rosso	0~100	Personalizza componenti RGB
	Verde	0~100	
	Blu	0~100	
IMPOSTAZIONE OSD	Lingua	English , Español , Русский , Français , 한국 , Português , Deutsch , Türkçe , 简体中文 , Polski , Italiano , Nederlands , 日本語	Imposta la lingua OSD
	POS. O. OSD	0~100	Regola la posizione orizzontale dell'OSD
	POS. V. OSD	0~100	Regola la posizione verticale dell'OSD
	Timer OSD	0~60	Imposta per quanto tempo l'OSD rimane aperto dopo il mancato utilizzo
	Trasparenza	0~100	Imposta la trasparenza generale dell'OSD

Menu principale	Menu secondario	Opzioni	Descrizione
Ripristina	Ripristina	N/A	Ripristina le configurazioni del monitor
	REGOLAZIONE AUTOM. IMMAGINE	N/A	Regolazione autom. immagine
	REGOLAZIONE AUTOM. COLORE	N/A	Regolazione autom. colore immagine
Varie	Origine segnale	HDMI 1, HDMI 2, DP	Visualizza il segnale di ingresso
	Volume	0-100	Regola il volume audio
	Raggi blu bassi	0-100	Imposta il livello di filtraggio della luce blu
	OVERDRIVE	Medio, Basso, Off	Imposta la funzione Overdrive
	Effetti LED	Off, Normale, Sfarfallio	
	Adaptive Sync	Attiva, Disattiva	Attiva/disattiva la funzione Adaptive Sync

9. Commutazione Modalità ECO e Gameplus

1. Premere uno dei tasti (M, ▲, ▼, E, ) per attivare la finestra di navigazione.

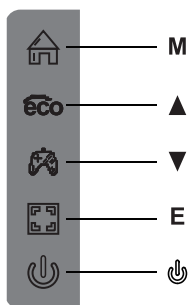

2. Premere il tasto ▲ per passare alle modalità ECO. Queste modalità includono Standard, Testo, Film, Gioco, FPS e RTS e possono essere utilizzate per ottimizzare le impostazioni in base alla propria attività. La modalità Standard è adatta per la maggior parte delle attività.



3. Premere il tasto ▼ per passare alle modalità Gameplus. In base alle esigenze del gioco, scegliere l'icona del gioco corrispondente. Queste icone di gioco sono progettate principalmente per ottimizzare l'obiettivo durante i giochi FPS, anche se possono essere utilizzate per altri scenari.



10. Specifiche Tecniche

Modello	LC-M24-FHD-165
Dimensioni schermo	23,8"
Proporzioni	16:9
Retroilluminazione	LED
Luminosità	250cd/m ²
Pannello	IPS
Risoluzione	DP1.2: 1920*1080 a 165Hz HDMI 1.4: 1920*1080 a 120Hz
Frequenza di aggiornamento	165Hz
Tempo di risposta	Veloce 1 ms
Angolo di visione	≥ 178° (O) / ≥ 178° (V)
Rapporto di contrasto	1000:1
Supporto VESA	75 x 75mm
Colori	16,7M
Adaptive Sync	Sì
Ingresso segnale	DP 1.2*1, HDMI 1.4*2, AUDIO OUT*1
Audio	
Altoparlanti	No
Uscita audio	Sì
Accessori	
Adattatore	Sì
Cavo DisplayPort	Sì
Altre funzioni	
Luce blu bassa	Sì
Dimensioni fisiche	
Dimensioni (con supporto)	543,5*498,2*200mm
Dimensioni (senza supporto)	543,5*323,5*45,3mm
Peso netto	4,7kg
Peso lordo	6,66kg

LC-POWER™

Silent Power Electronics GmbH

Formerweg 8

47877 Willich

Germany

www.lc-power.com

物料号码	108.007.13541		
厂内型号	SF22G	厂外型号	LC-M24-FHD-165
物料名称	说明书	品 牌	LC-POWER
协力厂商		日 期	20210219
规 格	140*210mm		
要 求	100g铜版 单色印刷 胶装		
版 本	V01	设 计	feihong
确 认		核 准	

备注：如不够页数，可以在封面封底的内面插入空白页