



# FORTNITE®

77070





Q LEGO® Builder



LEGO.com/sustainable-packaging



**FR**  
**DONNEZ**  
OU  
**RECYCLEZ**

 OU  OU 

ASSOCIATION MAGASIN DÉCHÈTERIE

Adresses sur [quefairedemesdechets.fr](http://quefairedemesdechets.fr)

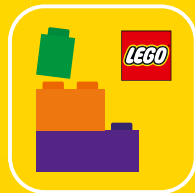

LEGO® Builder

# BUILDER



Apple and the Apple logo are trademarks of Apple Inc., registered in the U.S. and other countries and regions. App Store is a service mark of Apple Inc. Google Play and the Google Play logo are trademarks of Google LLC. Tencent and the Tencent logo are trademarks of Tencent Inc.

LEGO.com/devicecheck

**EN** Ask parents' permission before going online | **DE** Eltern um Erlaubnis bitten, bevor du online gehst | **FR** Demande l'autorisation d'un parent avant d'aller en ligne | **IT** Chiedi il permesso ai tuoi genitori prima di andare online | **ES** Pídeles permiso a tus papás antes de conectarte a Internet | **PT** Peça autorização aos pais antes de acederes online | **ZH** 上网前应先征得父母的同意 | **PL** Poproś rodziców o zgodę, zanim wejdiesz do Internetu | **CS** Než půjdeš na internet, požádej rodiče o svolení | **SK** Skôr než pôjdeš na internet, vypýtaj si povolenie od rodičov | **HU** Kérj szülői engedélyt, mielőtt online csatlakoznál! | **RO** Cere permisiunea părinților înainte de a te conecta online | **BG** Поискайте разрешение от родител, преди да влезете онлайн | **LV** Pirms došanās tiešsaistē palūdz atļauju vecākiem | **ET** Enne Interneti kasutamist küsi vanematelt luba | **LT** Prieš prisijungdami prie interneto, atsiklauskite tėvų



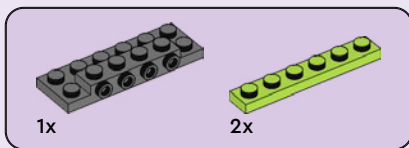

1

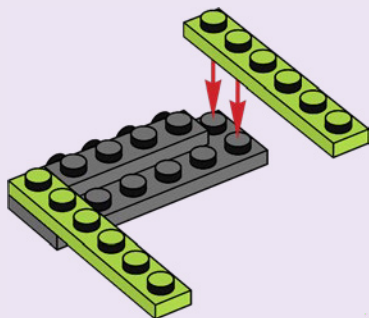

2

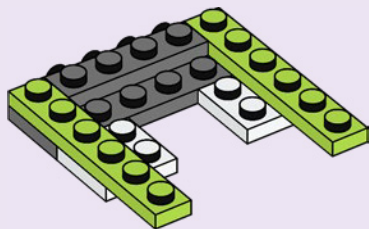



1x

3

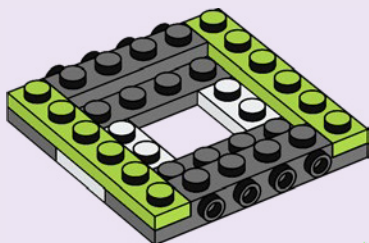

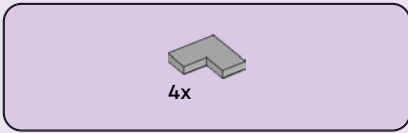

4

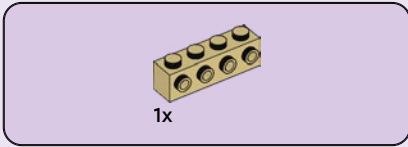
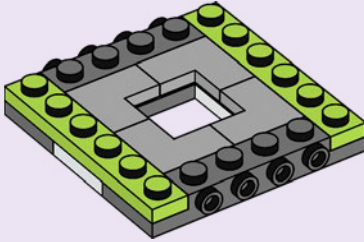

5

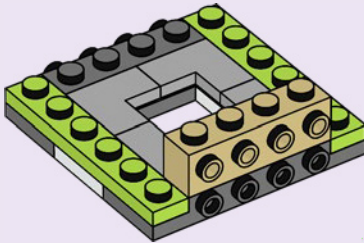



3x

6

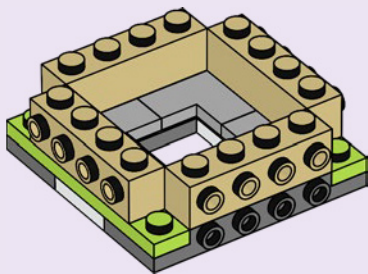



4x

7

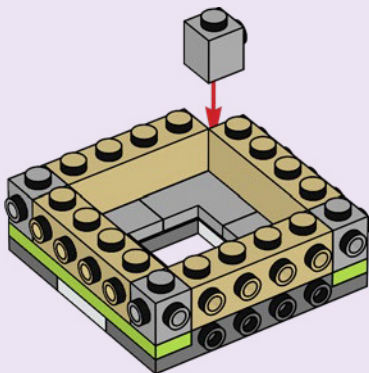



2x



4x

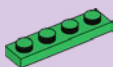

2x



2x



2x



2x



2x

8

1

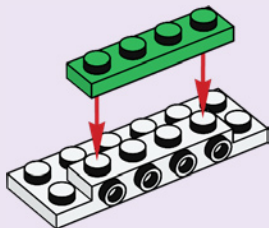

2

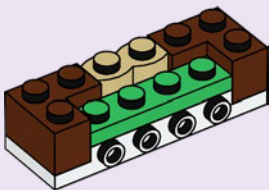

3

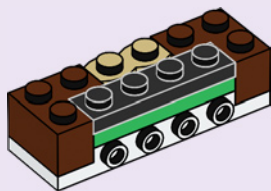

4

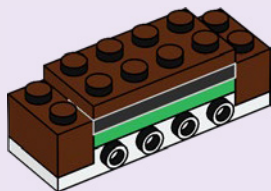

2x

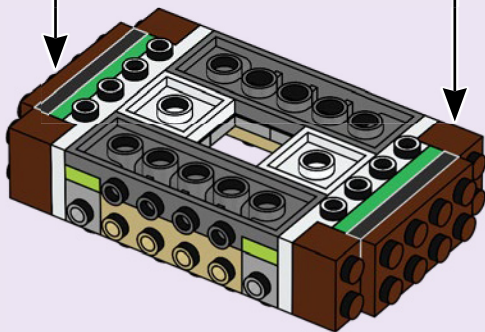

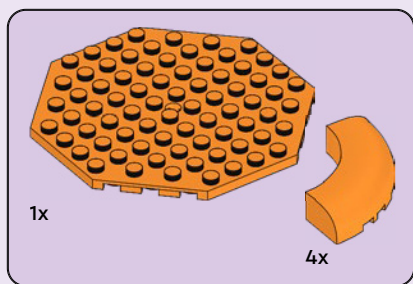

9

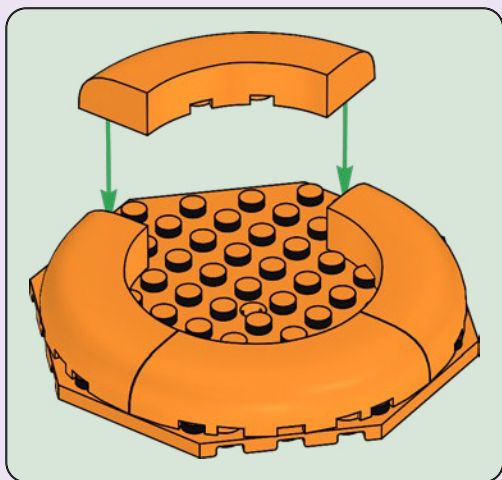

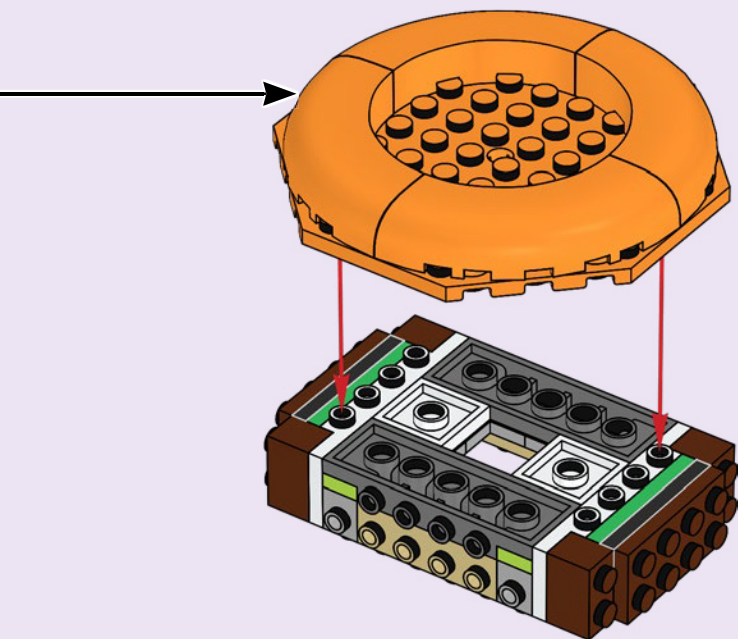
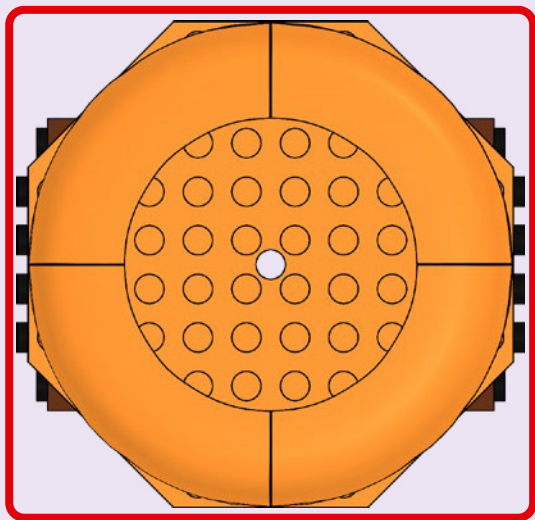



2x

10

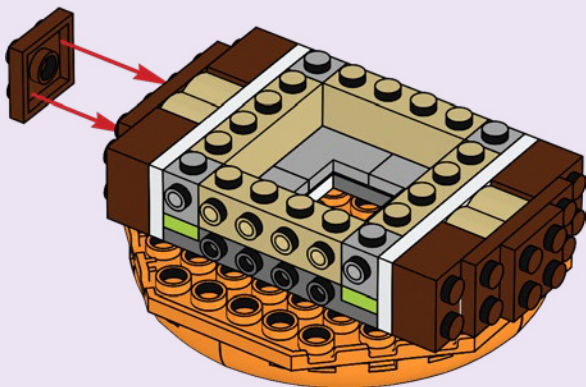

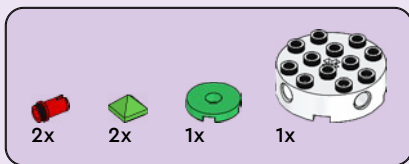

11

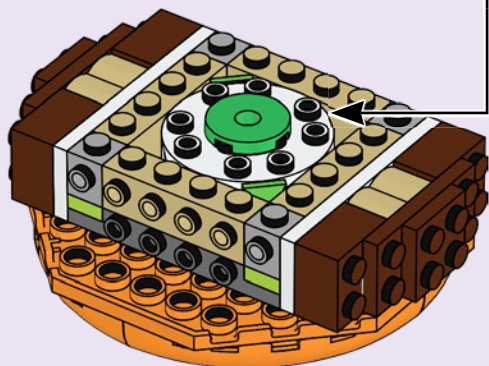
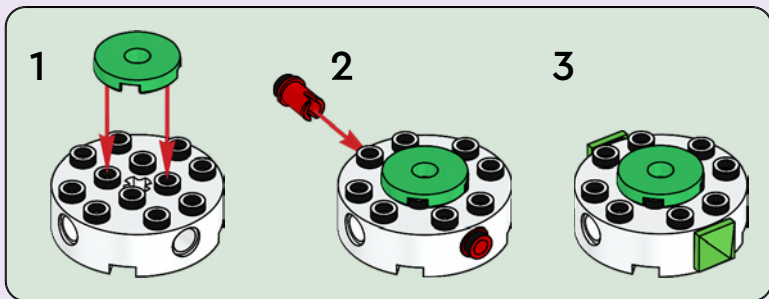



2x

12

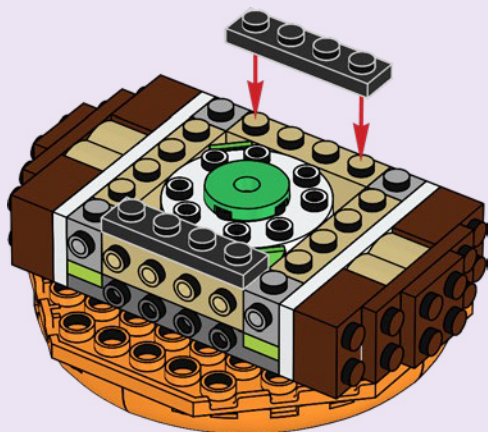



6x

13

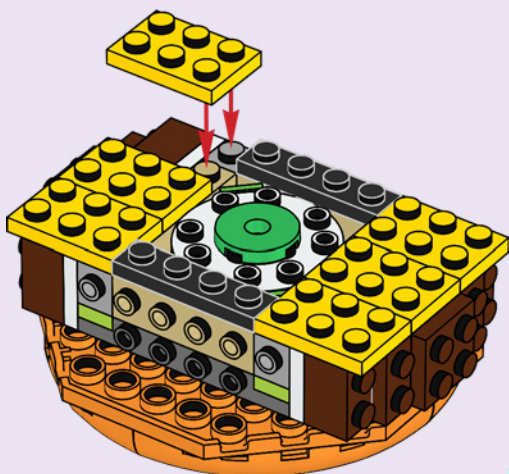

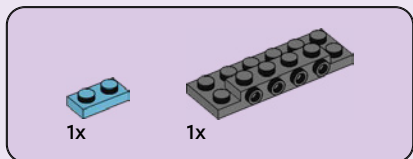
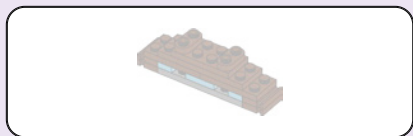

14

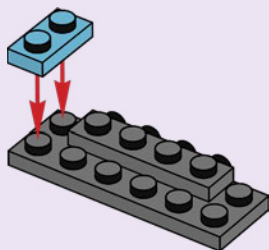

15

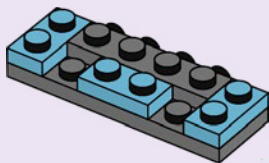



16

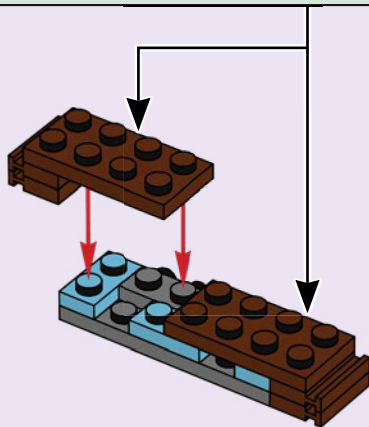
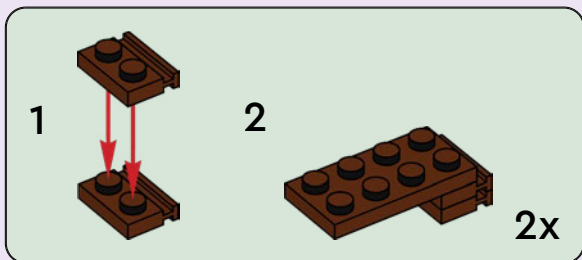

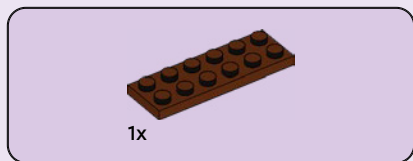

17

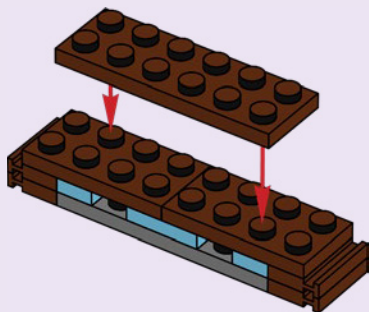

18

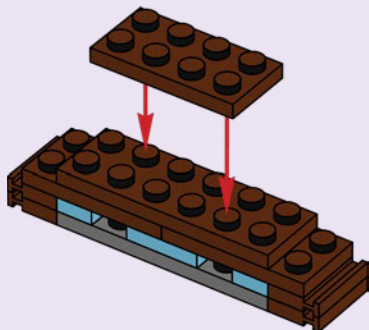



2x

19

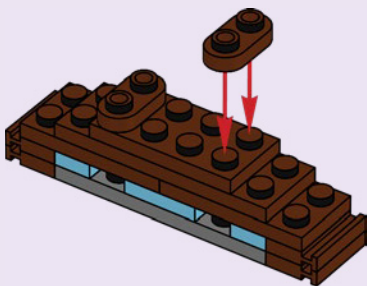

20

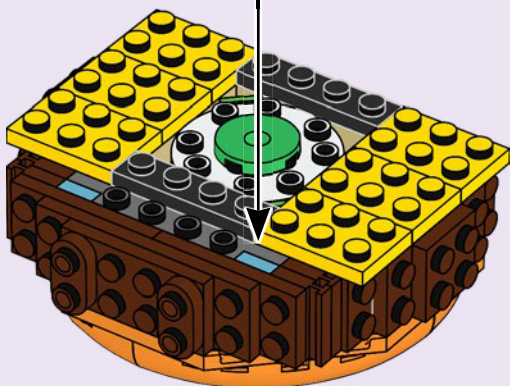



1x



1x

# 21

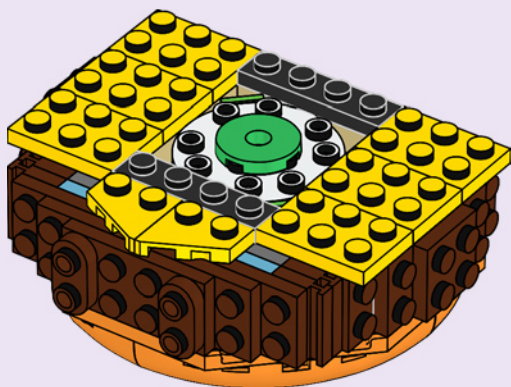



1x



2x



2x

# 22

1



2



3

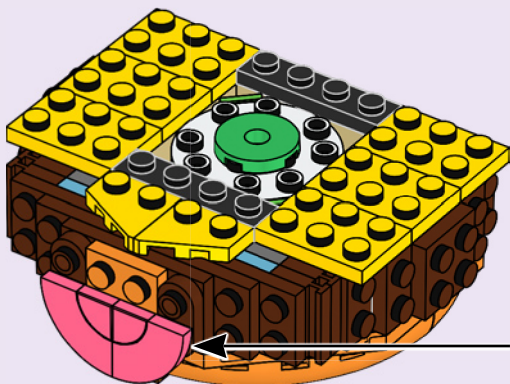
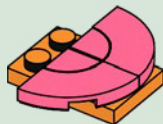

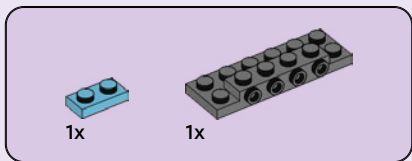
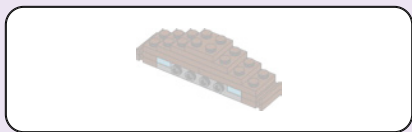

23

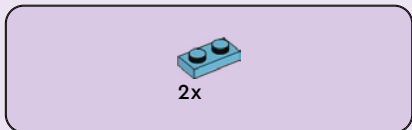
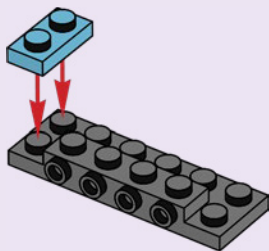

24

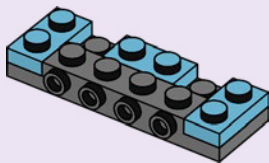

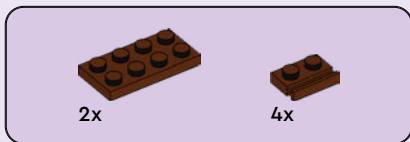

25

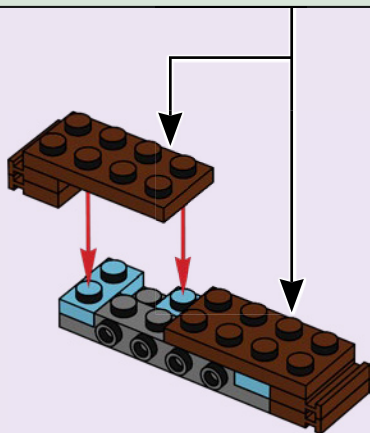
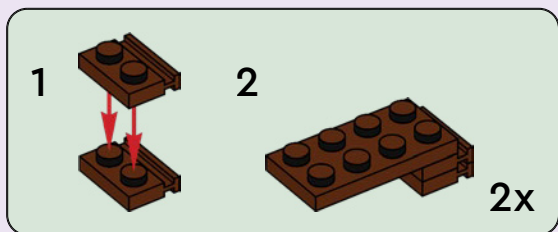



1x

# 26

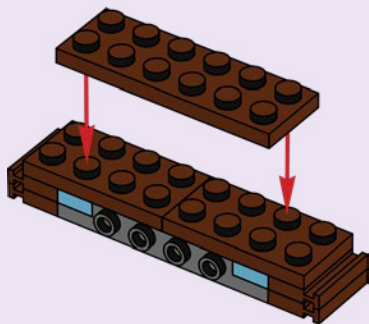

1x

# 27

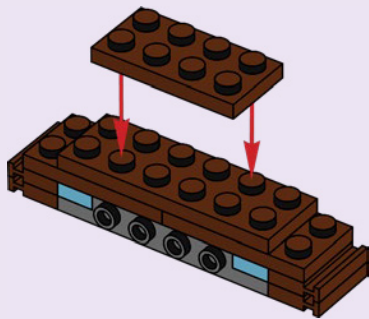



1x

28

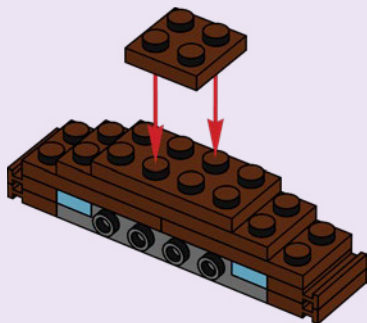

29

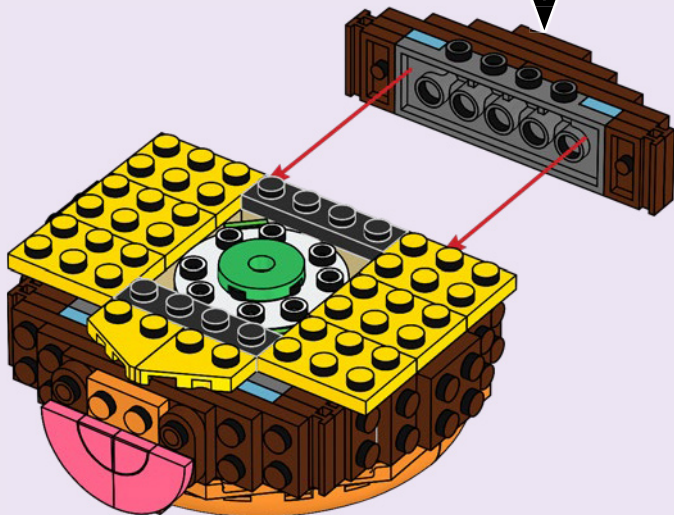

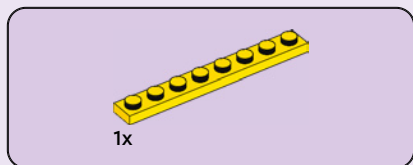

30

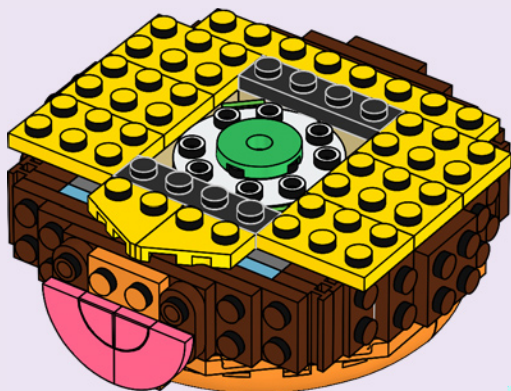

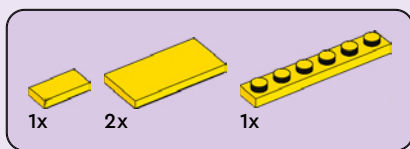

# 31

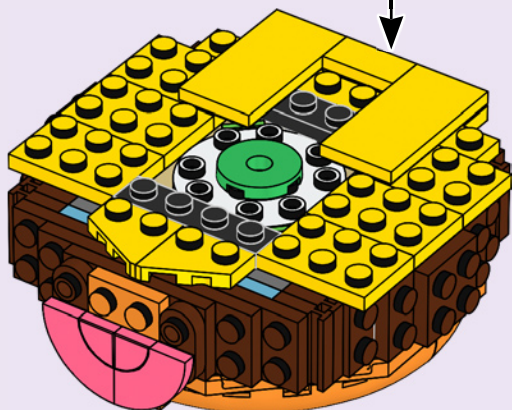
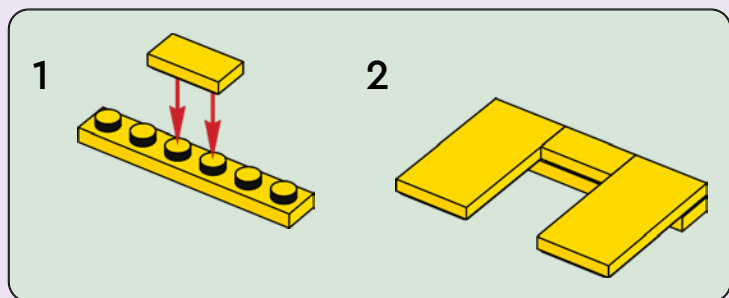

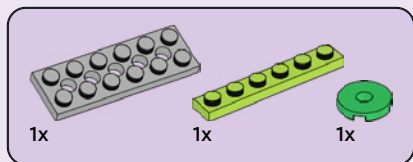

# 32

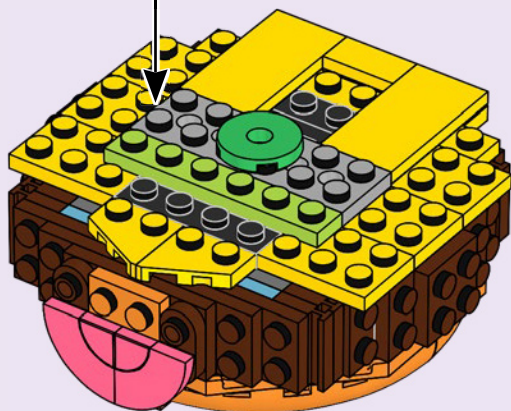
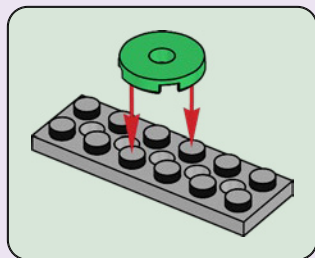



2x



2x

# 33

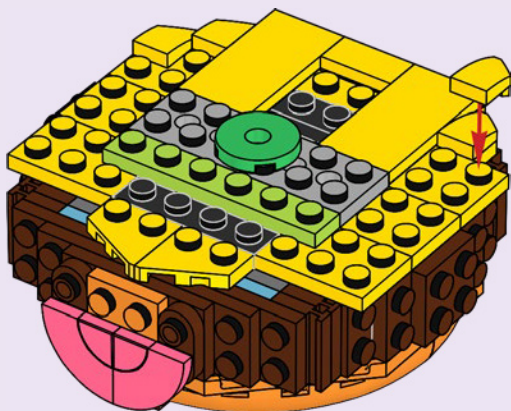

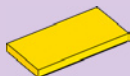

2x

34

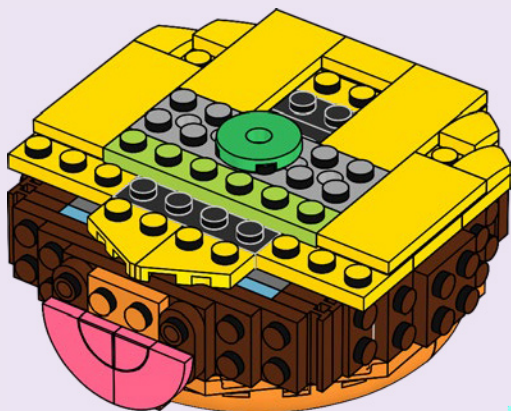

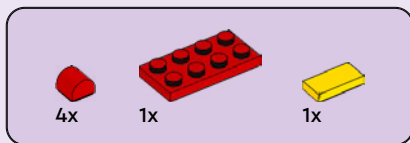

# 35

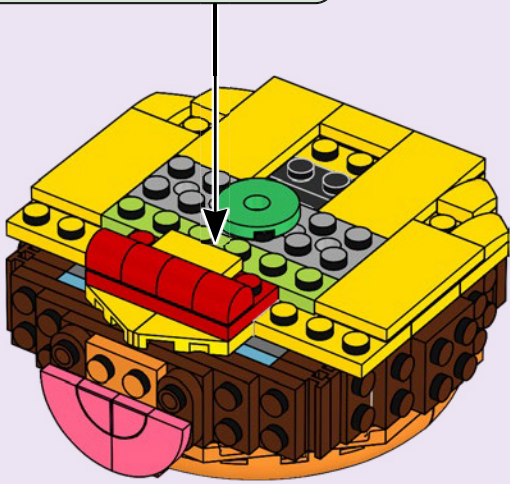
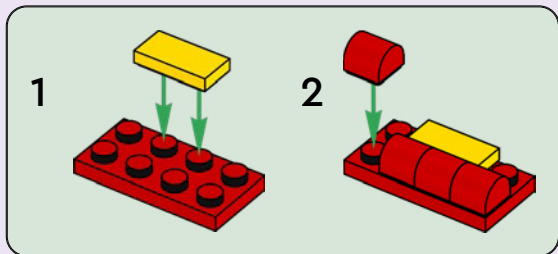



2x



1x



1x

# 36

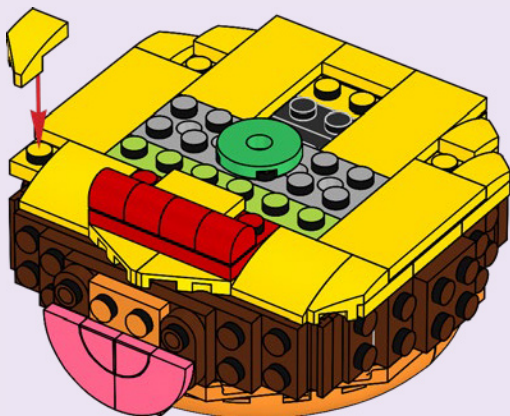

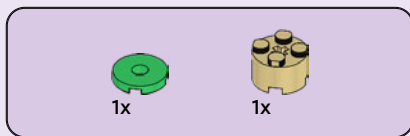

37

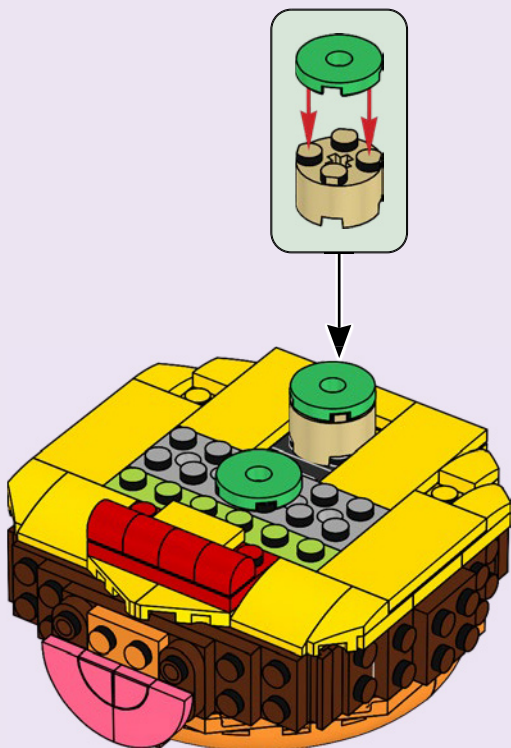



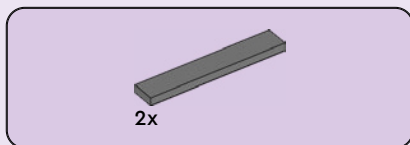

38

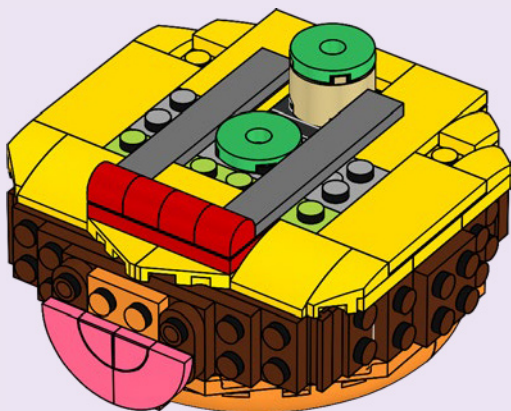

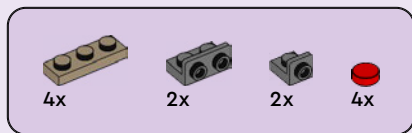

39

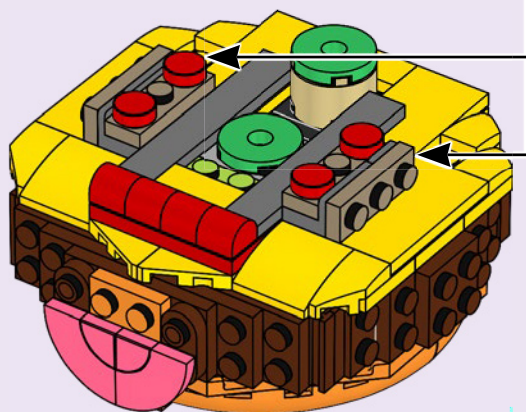
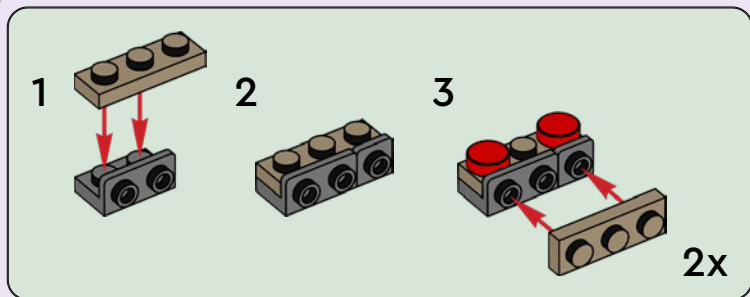

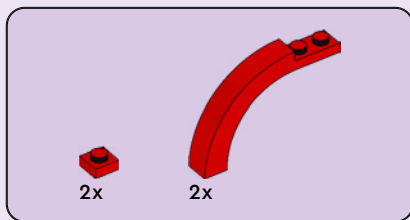

40

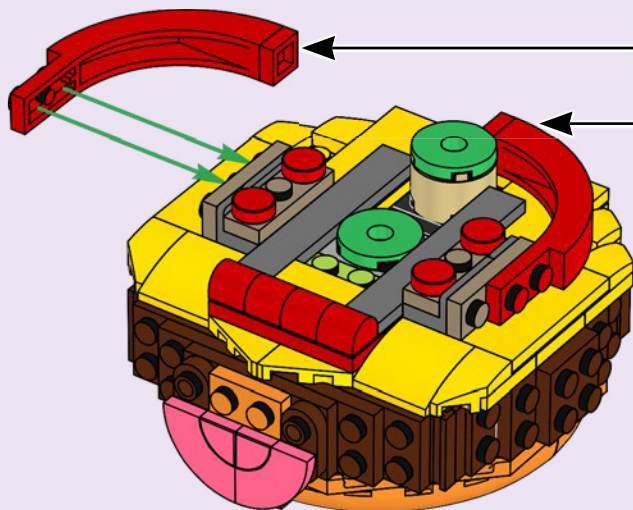
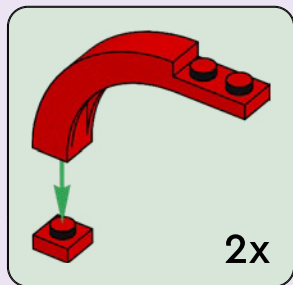



2x

41

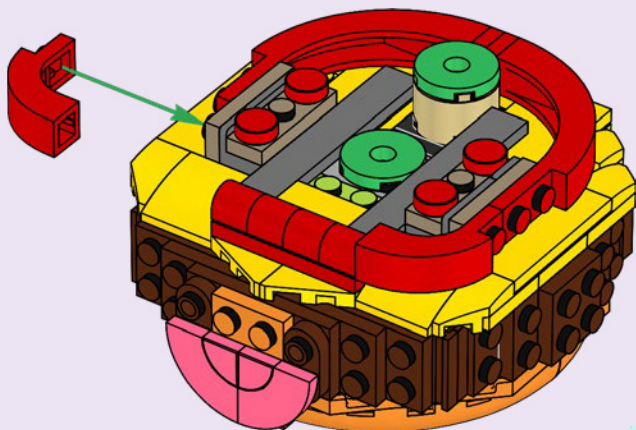



2x

42

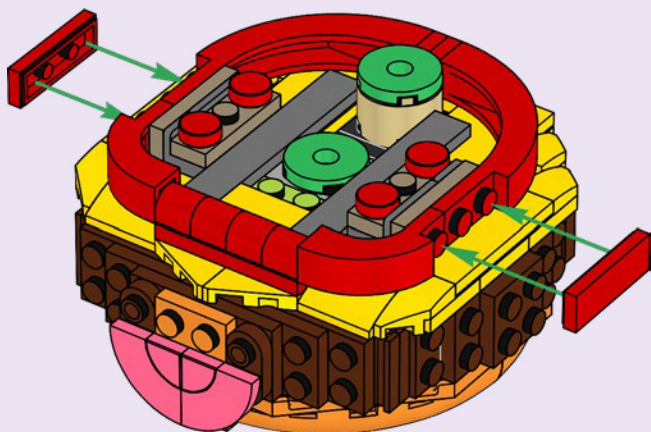

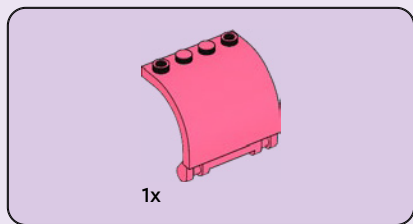

43

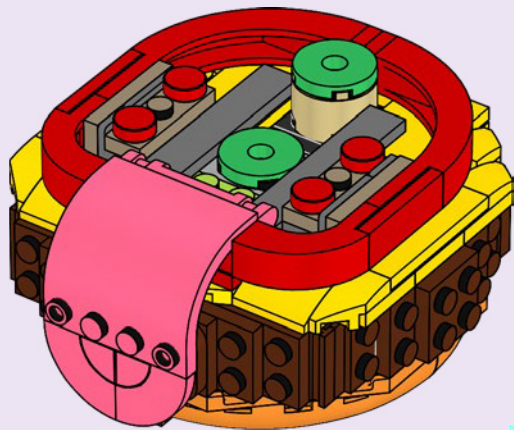

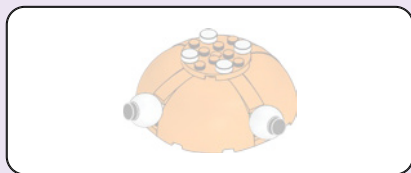

44



45

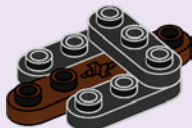



2x



1x

# 46

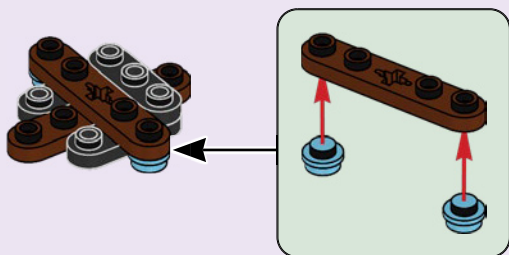



1x

47





2x

48

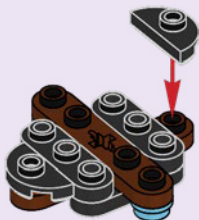

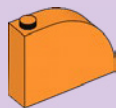

2x

49

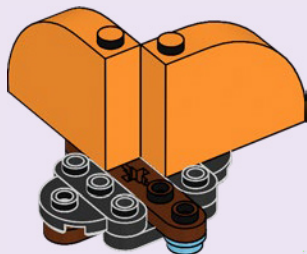

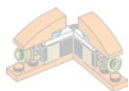

1x



1x

# 50

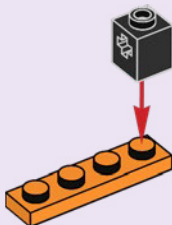

1x

# 51

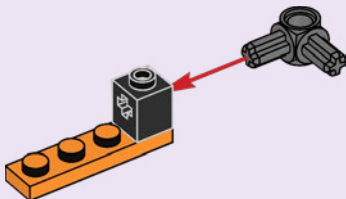



1x



1x

# 52

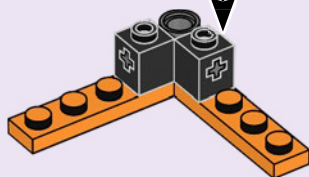
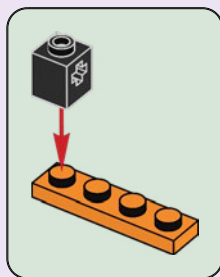



2x



2x

# 53

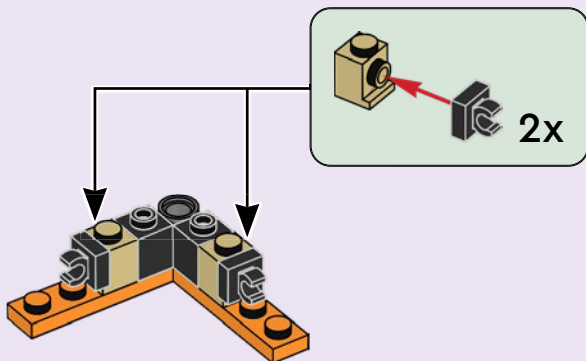



2x

# 54

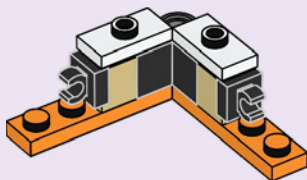



2x

55

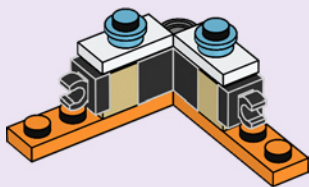

2x



2x

56



2x

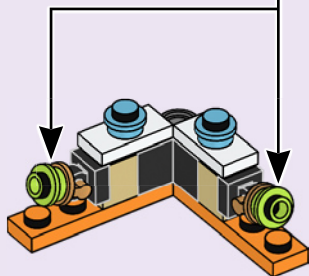



2x

57

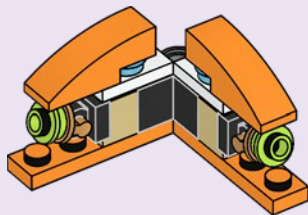

58

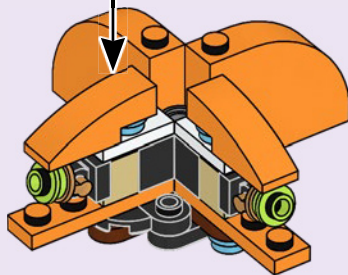

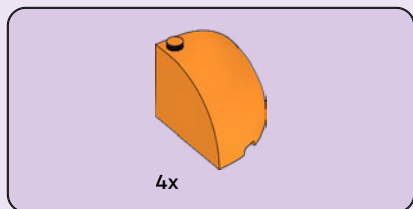

59

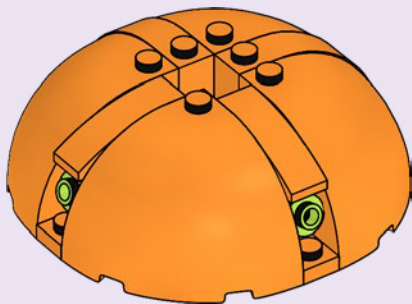



1x

60

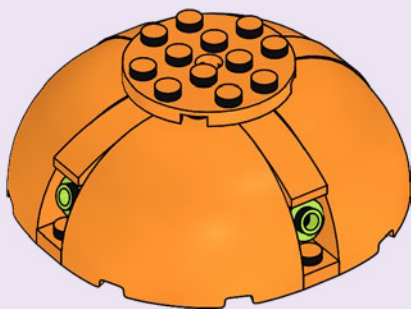



4x

61

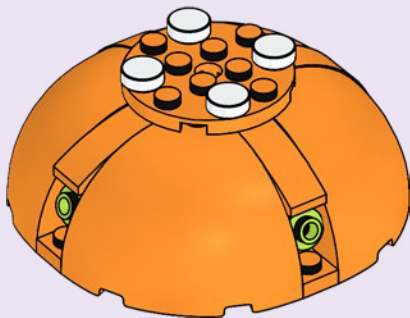



62

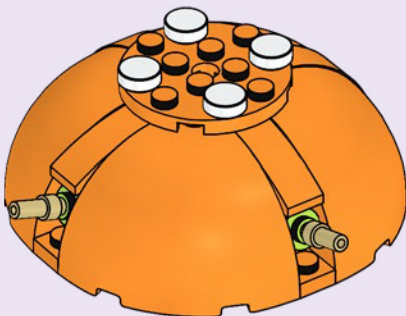

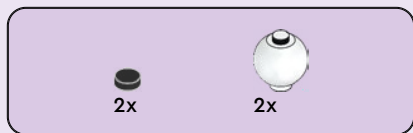

63

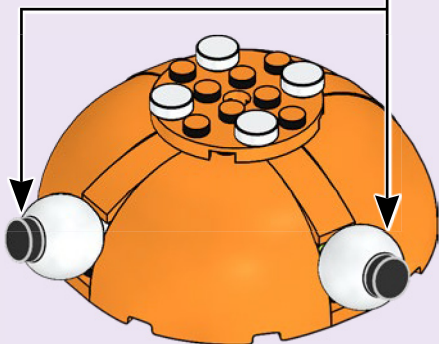
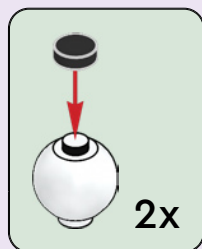

64

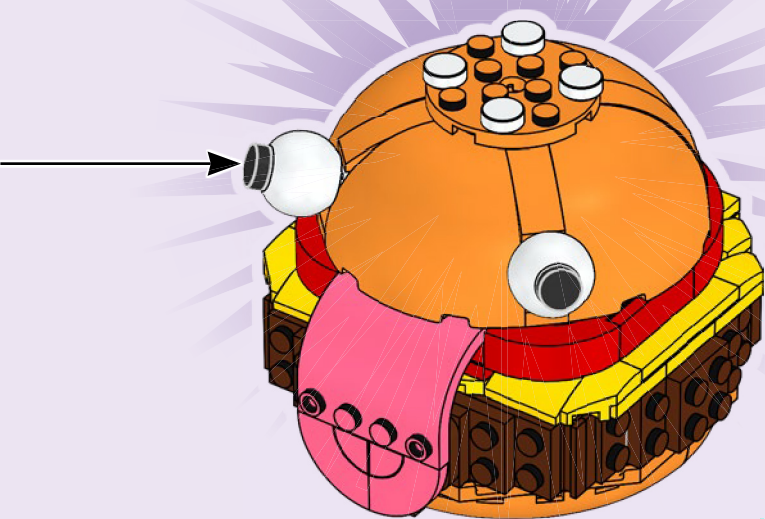

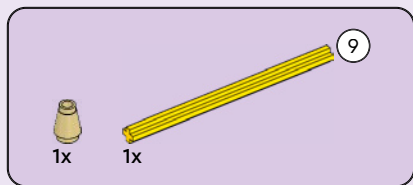

65

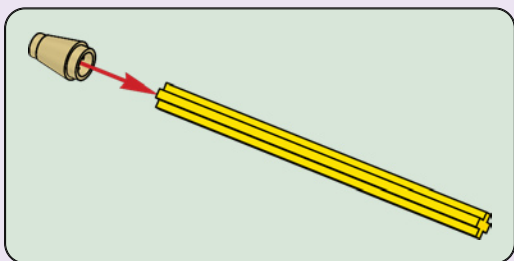

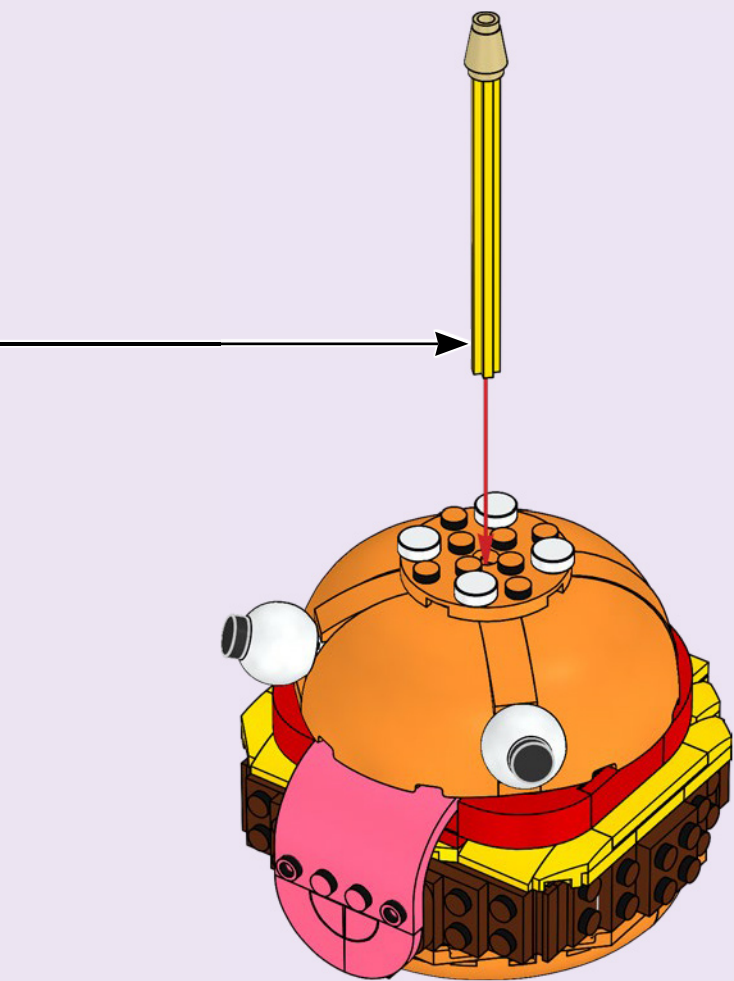



1x



1x

66

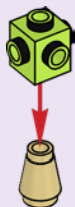



67

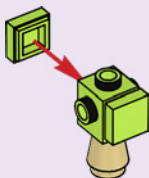

68





2x

69





1x



1x

# 70

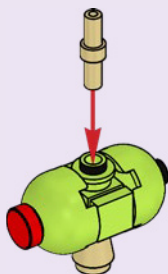

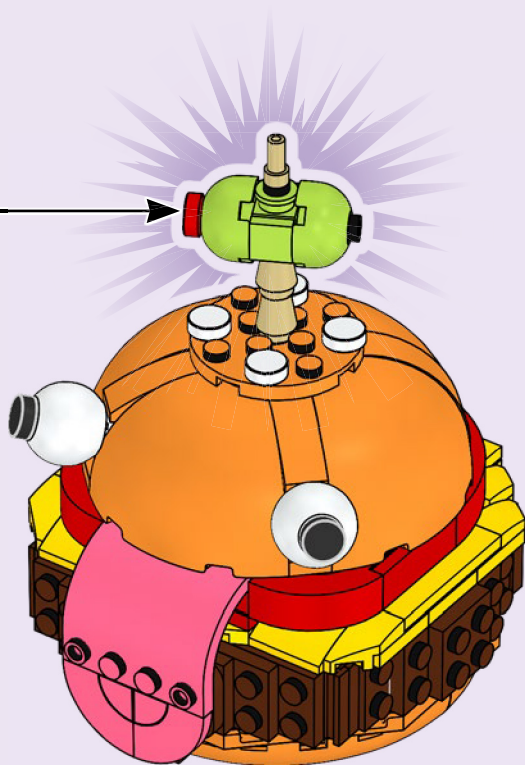

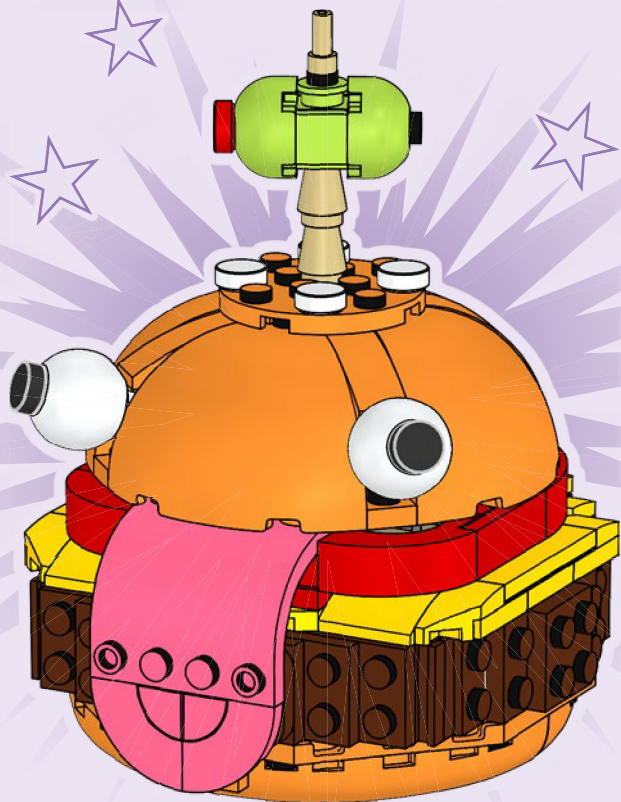



# FORTNITE

77072



77070



77071

77073



  
4x  
6284572

  
2x  
6221773

  
2x  
6051511

  
2x  
302201

  
1x  
4203583

  
2x  
6430548

  
2x  
4529237

  
2x  
4118793

  
3x  
6447501

  
1x  
4125220

  
2x  
4218749

  
4x  
4201062

  
5x  
6284574

  
4x  
6278441

  
2x  
6378120

  
2x  
302421

  
2x  
4533742

  
2x  
6212012

  
1x  
302021

  
2x  
6297822

  
3x  
6289740

  
1x  
6132609

  
1x  
6132201

  
3x  
6289743

  
2x  
306924

  
2x  
6079007

  
6x  
302124

  
4x  
4560181

  
1x  
366624

  
1x  
346024

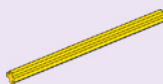
  
1x  
6130010

  
2x  
6284070

  
2x  
6335388

  
2x  
6344819

  
2x  
6438919

  
4x  
6428168

  
4x  
371026

  
2x  
4251969

  
4x  
6515842

  
1x  
4125278

  
2x  
4118782

  
2x  
6515841

  
1x  
6226926

  
4x  
6515840

  
1x  
6515843

3x  
6190251

2x  
4537251

1x  
6174006

2x  
6429057

3x  
4529160

2x  
6248944

8x  
4645103

4x  
4211200

3x  
4216695

2x  
6280388

8x  
4211186

2x  
4211247

4x  
6267495

4x  
6065824

1x  
4211542

4x  
6132768

3x  
6074954

2x  
6299946

2x  
371028

2x  
6501299

4x  
6102986

6x  
6097419

2x  
6250022

2x  
6250024

1x  
6510319

2x  
6225494

1x  
6005331

2x  
6000606

2x  
4210651

4x  
6401210



 [LEGO.com/service](https://www.LEGO.com/service)

YOU COULD

WIN



Scan this QR code or go to **LEGO.COM/PRODUCTFEEDBACK** and give us your short feedback about this LEGO® set for a chance to win a cool LEGO prize.

Terms and Conditions apply\*

**EN: YOU COULD WIN.** Terms and Conditions apply\* **DE: Du könntest GEWINNEN.** Es gelten die Teilnahmebedingungen\* **FR: Tu pourrais GAGNER.** Des conditions s'appliquent\* **IT: Potresti VINCERE tu.** Termini e condizioni sono applicabili\* **ES: Puedes GANAR.** Aplican términos y condiciones\* **PT: Poderá GANHAR.** Aplicam-se termos e condições\* **ZH: 轻松获奖. 条款和条件适用\*** **PL: Szansa na WYGRANĄ.** Obowiązują warunki korzystania\* **CS: Máte šanci VYHRÁT.** Platí všeobecné smluvní podmínky\* **SK: Máte šancu VYHRAŤ.** Platia všeobecné zmluvné podmienky\* **HU: TE IS NYERHETSZ.** Felhasználási feltételek érvényesek\* **RO: Ai putea CÂȘTIGA.** Se aplică termenii și condiții\* **BG: Можете да СПЕЧЕЛИТЕ.** Има определени правила и условия\* **LV: Tu vari LAIMĒT.** Ir spēkā noteikumi un nosacījumi.\* **ET: Sul on võimalus VÕITA.** Kehtivad tingimused\* **LT: Jūs galite LAIMĖTI.** Taikomos sąlygos\*

\*[LEGO.com/productfeedback-terms](https://www.lego.com/productfeedback-terms)