

TASCAM

D01174820B

CD-200SB

CD / Solid State Player

OWNER'S MANUAL

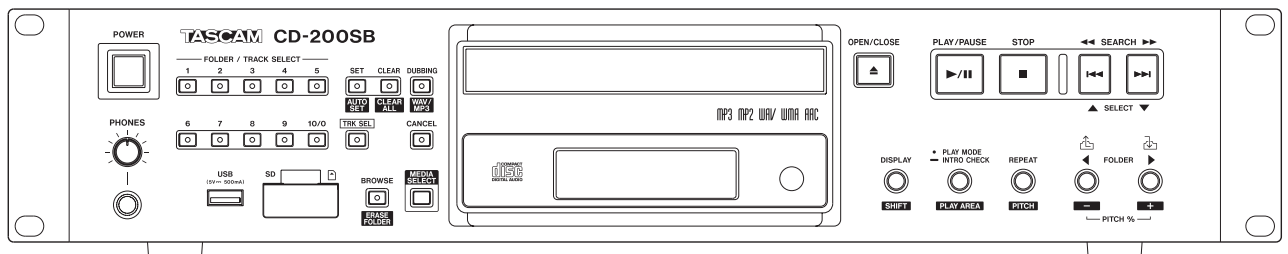

IMPORTANT SAFETY PRECAUTIONS



CAUTION
RISK OF ELECTRIC SHOCK
DO NOT OPEN



CAUTION: TO REDUCE THE RISK OF ELECTRIC SHOCK, DO NOT REMOVE COVER (OR BACK). NO USER-SERVICEABLE PARTS INSIDE. REFER SERVICING TO QUALIFIED SERVICE PERSONNEL.



The lightning flash with arrowhead symbol, within equilateral triangle, is intended to alert the user to the presence of uninsulated "dangerous voltage" within the product's enclosure that may be of sufficient magnitude to constitute a risk of electric shock to persons.



The exclamation point within an equilateral triangle is intended to alert the user to the presence of important operating and maintenance (servicing) instructions in the literature accompanying the appliance.

WARNING: TO PREVENT FIRE OR SHOCK HAZARD, DO NOT EXPOSE THIS APPLIANCE TO RAIN OR MOISTURE.

For U.S.A.

This equipment complies with Part 15 of FCC Rules. Operation is subject to the following two conditions:

- 1) This device may not cause interference and
- 2) This device must accept any interference, including interference that may cause undesired operation of the device.

INFORMATION TO THE USER

This equipment has been tested and found to comply with the limits for a Class A digital device, pursuant to Part 15 of the FCC Rules. These limits are designed to provide reasonable protection against harmful interference when the equipment is operated in a commercial environment. This equipment generates, uses, and can radiate radio frequency energy and, if not installed and used in accordance with the instruction manual, may cause harmful interference to radio communications.

Operation of this equipment in a residential area is likely to cause harmful interference in which case the user will be required to correct the interference at his own expense.

CAUTION

Changes or modifications to this equipment not expressly approved by TEAC CORPORATION for compliance could void the user's authority to operate this equipment.

In North America use only on 120V supply.

This appliance has a serial number located on the rear panel. Please record the model number and serial number and retain them for your records.

Model number _____

Serial number _____

■ For European Customers

Disposal of electrical and electronic equipment

- (a) All electrical and electronic equipment should be disposed of separately from the municipal waste stream via collection facilities designated by the government or local authorities.
- (b) By disposing of electrical and electronic equipment correctly, you will help save valuable resources and prevent any potential negative effects on human health and the environment.
- (c) Improper disposal of waste electrical and electronic equipment can have serious effects on the environment and human health because of the presence of hazardous substances in the equipment.
- (d) The Waste Electrical and Electronic Equipment (WEEE) symbol, which shows a wheeled bin that has been crossed out, indicates that electrical and electronic equipment must be collected and disposed of separately from household waste.



- (e) Return and collection systems are available to end users. For more detailed information about the disposal of old electrical and electronic equipment, please contact your city office, waste disposal service or the shop where you purchased the equipment.

WARNING

This is a Class A product. In a domestic environment, this product may cause radio interference in which case the user may be required to take adequate measures.

For Canada

THIS CLASS A DIGITAL APPARATUS COMPLIES WITH CANADIAN ICES-003.CET

APPAREIL NUMERIQUE DE LA CLASSE B EST CONFORME A LA NORME NMB-003 DU CANADA.

CE Marking Information

- a) Applicable electromagnetic environment: E4
- b) The average half-cycle r.m.s. inrush current
 1. On initial switch-on : 0.4Arms
 2. After a supply interruption of 5s : 0.14Arms

IMPORTANT SAFETY INSTRUCTIONS

- 1 Read these instructions.
- 2 Keep these instructions.
- 3 Heed all warnings.
- 4 Follow all instructions.
- 5 Do not use this apparatus near water.
- 6 Clean only with dry cloth.
- 7 Do not block any ventilation openings. Install in accordance with the manufacturer's instructions.
- 8 Do not install near any heat sources such as radiators, heat registers, stoves, or other apparatus (including amplifiers) that produce heat.
- 9 Do not defeat the safety purpose of the polarized or grounding-type plug. A polarized plug has two blades with one wider than the other. A grounding type plug has two blades and a third grounding prong. The wide blade or the third prong are provided for your safety. If the provided plug does not fit into your outlet, consult an electrician for replacement of the obsolete outlet.
- 10 Protect the power cord from being walked on or pinched particularly at plugs, convenience receptacles, and the point where they exit from the apparatus.
- 11 Only use attachments/accessories specified by the manufacturer.
- 12 Use only with the cart, stand, tripod, bracket, or table specified by the manufacturer, or sold with the apparatus. When a cart is used, use caution when moving the cart/apparatus combination to avoid injury from tip-over.



- 13 Unplug this apparatus during lightning storms or when unused for long periods of time.
- 14 Refer all servicing to qualified service personnel. Servicing is required when the apparatus has been damaged in any way, such as power-supply cord or plug is damaged, liquid has been spilled or objects have fallen into the apparatus, the apparatus has been exposed to rain or moisture, does not operate normally, or has been dropped.

- The apparatus draws nominal non-operating power from the AC outlet with its POWER or STANDBY/ON switch not in the ON position.
- The mains plug is used as the disconnect device, the disconnect device shall remain readily operable.
- Caution should be taken when using earphones or headphones with the product because excessive sound pressure (volume) from earphones or headphones can cause hearing loss.
- If you are experiencing problems with this product, contact TEAC for a service referral. Do not use the product until it has been repaired.

CAUTION

- Do not expose this apparatus to drips or splashes.
- Do not place any objects filled with liquids, such as vases, on the apparatus.
- Do not install this apparatus in a confined space such as a book case or similar unit.
- The apparatus should be located close enough to the AC outlet so that you can easily grasp the power cord plug at any time.
- If the product uses batteries (including a battery pack or installed batteries), they should not be exposed to sunshine, fire or excessive heat.
- CAUTION for products that use replaceable lithium batteries: there is danger of explosion if a battery is replaced with an incorrect type of battery. Replace only with the same or equivalent type.

WARNING

- Products with Class I construction are equipped with a power supply cord that has a grounding plug. The cord of such a product must be plugged into an AC outlet that has a protective grounding connection.

■ RACK-MOUNTING THE UNIT

Use the supplied rack-mounting kit to mount the unit in a standard 19-inch rack, as shown below.

Remove the feet of the unit before mounting.

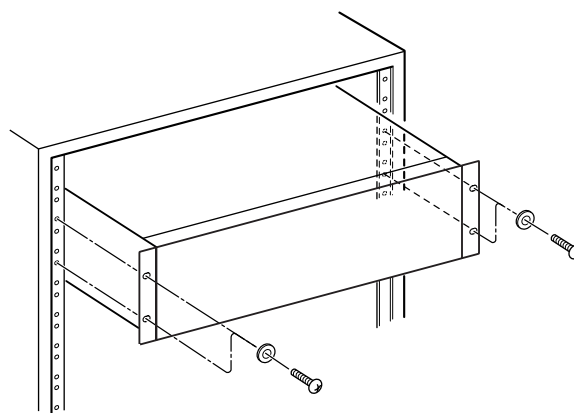

CAUTION

- Leave 1U of space above the unit for ventilation.
- Allow at least 10 cm (4 in) at the rear of the unit for ventilation.

Safety Information

■ CAUTIONS ABOUT BATTERIES

This product uses batteries. Misuse of batteries could cause a leak, rupture or other trouble. Always abide by the following precautions when using batteries.

- Never recharge non-rechargeable batteries. The batteries could rupture or leak, causing fire or injury.
- When installing batteries, pay attention to the polarity indications (plus/minus (+/-) orientation), and install them correctly in the battery compartment as indicated. Putting them in backward could make the batteries rupture or leak, causing fire, injury or stains around them.
- When you store or dispose batteries, isolate their terminals with insulation tape or something like that to prevent them from contacting other batteries or metallic objects.
- When throwing used batteries away, follow the disposal instructions indicated on the batteries and the local disposal laws.
- Do not use batteries other than those specified. Do not mix and use new and old batteries or different types of batteries together. The batteries could rupture or leak, causing fire, injury or stains around them.
- Do not carry or store batteries together with small metal objects. The batteries could short, causing leak, rupture or other trouble.
- Do not heat or disassemble batteries. Do not put them in fire or water. Batteries could rupture or leak, causing fire, injury or stains around them.
- If the battery fluid leaks, wipe away any fluid on the battery case before inserting new batteries. If the battery fluid gets in an eye, it could cause loss of eyesight. If fluid does enter an eye, wash it out thoroughly with clean water without rubbing the eye and then consult a doctor immediately. If the fluid gets on a person's body or clothing, it could cause skin injuries or burns. If this should happen, wash it off with clean water and then consult a doctor immediately.
- The unit power should be off when you install and replace batteries.
- Remove the batteries if you do not plan to use the unit for a long time. Batteries could rupture or leak, causing fire, injury or stains around them. If the battery fluid leaks, wipe away any fluid on the battery compartment before inserting new batteries.
- Do not disassemble a battery. The acid inside the battery could harm skin or clothing.

■ CAUTIONS ABOUT LASER RADIATION

This product has been designed and manufactured according to FDA regulations "title 21, CFR, chapter 1, subchapter J, based on the Radiation Control for Health and Safety Act of 1968," and is classified as a class 1 laser product. There is no hazardous invisible laser radiation during operation because invisible laser radiation emitted inside of this product is completely confined in the protective housings.

The label required in this regulation is shown at ①.

For U.S.A

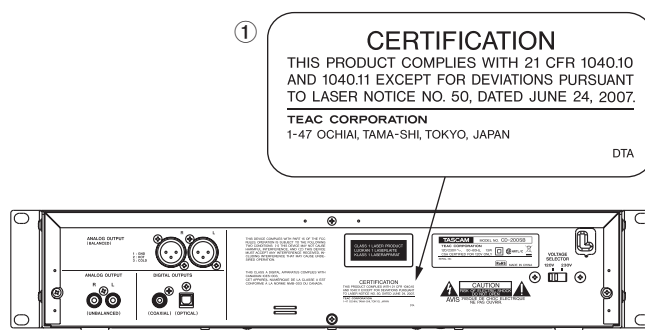

Cautions:

- DO NOT REMOVE THE PROTECTIVE HOUSING USING A SCREWDRIVER.
- USE OF CONTROLS OR ADJUSTMENTS OR PERFORMANCE OF PROCEDURES OTHER THAN THOSE SPECIFIED HEREIN MAY RESULT IN HAZARDOUS RADIATION EXPOSURE.
- IF THIS PRODUCT DEVELOPS TROUBLE, CONTACT YOUR NEAREST QUALIFIED SERVICE PERSONNEL, AND DO NOT USE THE PRODUCT IN ITS DAMAGED STATE.

Optical pickup

Type	: SF-P101V
Manufacturer	: Sanyo Electric Co.,Ltd.
Laser output	: Less than 0.2 mW on the objective lens
Wavelength	: 790 +/- 25nm
Standard	: IEC60825-1:2007

1 – Introduction	7	Playback.....	22
Features	7	Selecting a track	23
Included items	7	Skipping to the next or previous track.....	23
Conventions used in this manual	7	Selecting by track number	23
Trademarks.....	8	Search forward and backward	23
Precautions for placement	8	Folder playback (data CDs/SD cards/USB flash drives).....	24
Power supply	8	Setting the playback folder	24
Beware of condensation.....	8	Programmed playback.....	24
Cleaning the unit.....	8	Setting the program	25
SD cards and USB flash drives	9	Checking the program	26
Handling precautions.....	9	Replacing a program track	26
About media that have been confirmed for use with this unit	9	Adding more program tracks	26
SD card/USB flash drive write-protection	9	Clearing the program	26
Precaution regarding use with Mac operating systems.....	9	Repeat playback.....	27
About discs.....	9	Time and text information display	27
Handling of compact discs	9	Pitch control (with CDs only).....	28
2 – Names and functions of parts	10	Intro Check function	29
Top panel	10	5 – Browsing	30
Rear panel.....	12	Browsing folders and files.....	30
Display.....	13	6 – Direct folder function	32
Remote control unit (TASCAM RC-CD200SB)	14	Saving direct folder settings.....	32
3 – Preparations	16	Assigning direct folders.....	32
Making connections	16	Assigning direct folders individually	33
Preparing the remote control.....	17	Automatically assign all direct folders (AUTO SET).....	33
Inserting batteries.....	17	Changing individual direct folder assignments.....	34
Replacing the batteries.....	17	Direct folder playback	35
Cautions about the use of batteries.....	17	Setting the playback area with direct folders..	35
Cautions about using the remote control.....	17	Selecting the playback mode with direct folders.....	35
Loading a CD	17	Using folder search/browse functions during direct folder playback	36
Inserting and removing SD cards	18	Clearing direct folder assignments	36
Inserting SD cards.....	18	Clearing individual direct folder assignments	36
Removing SD cards.....	18	Clearing all direct folder assignments (CLEAR ALL)	37
SD card write-protection switches	18	7 – Dubbing (copying)	38
Connecting and disconnecting USB flash drives ..	19	Dubbing overview.....	38
Connecting USB flash drives	19	Dubbing	39
Disconnecting USB flash drives	19	Dubbing using a 1–10/0 button that already has a direct folder assignment	40
Selecting the playback media	19	Recording times when dubbing.....	41
4 – Playback	20	8 – Erase folder function	42
Playable media and files	20	Erasing folders.....	42
Folders and tracks on data CDs, SD cards and USB flash drives	20		
Playback area	21		
Setting the playback area	21		
Playback modes.....	21		
Selecting the playback mode	22		

Contents

9 – Message Lists	43
Operation messages.....	43
Warning messages	43
Error messages.....	44
10 – Troubleshooting	45
11 – Specifications	46
Ratings	46
Output ratings.....	46
Analog audio output ratings.....	46
Digital audio output ratings.....	46
Audio performance.....	46
Backup memory	46
General	47
Dimensions	47

■ For China

产品有毒有害物质或元素的名称及含量

机种：CD-200SB		有毒有害物质或元素					
	品名	铅 (Pb)	汞 (Hg)	镉 (Cd)	六价铬 (Cr6+)	多溴联苯 (PBB)	多溴二苯醚 (PBDE)
1	CHASSIS 部份	○	○	○	○	○	○
2	FRONT PANEL 部份	○	○	○	○	○	○
3	螺丝部份	○	○	○	○	○	○
4	线材部份	○	○	○	○	○	○
5	PCB Assy 部份	×	○	○	○	○	○
6	CD MECH 部份	○	○	○	○	○	○
7	电源部份	○	○	○	○	○	○
8	附属品部份	×	○	○	○	○	○
9	LABEL 部份	○	○	○	○	○	○
10	包装部份	○	○	○	○	○	○

○：表示该有毒有害物质在该部件所有均质材料中的含量均在 SJ/T11363-2006 标准规定的限量要求以下。

×：表示该有毒有害物质至少在该部件的某一均质材料中的含量超出 SJ/T11363-2006 标准规定的限量要求。

(针对现在代替技术困难的电子部品及合金中的铅)

1 – Introduction

Thank you for your purchase of the TASCAM CD-200SB CD / Solid State Player.

Before connecting and using the unit, please take time to read this manual thoroughly to ensure you understand how to properly set up and connect the unit, as well as the operation of its many useful and convenient functions. After you have finished reading this manual, please keep it in a safe place for future reference.

You can also download the Owner's Manual from the TASCAM web site (<http://tascam.com>).

Features

- Plays back audio CDs (CD-DA) and data CDs (CD-ROM/RW) with WAV, MP3 and MP2 format files.
- 2U rack mount size
- Plays back MP3, MP2, WAV, WMA and AAC format files on SD cards and USB flash drives
- Analog (RCA and XLR) and digital (coaxial and optical) outputs
- Headphone output with level control
- TASCAM RC-CD200SB remote control with number (1–10/0) buttons included
- Displays textual information (artist name, album name, track name, etc.) including CD text, ID3, WMA and AAC tags.
- 4 playback modes (continuous, single, random and program)
- Repeat playback function can be turned ON and OFF
- Playback area can be designated (ALL PLAY, FOLDER) for data CDs, SD cards and USB flash drives.
- CD playback pitch control function ($\pm 14\%$)
- Intro check function
- Time display options include track elapsed time, track remaining time and total remaining time for audio CDs, track elapsed time for data CDs and track elapsed time and track remaining time for SD cards and USB flash drives
- CD drive has 10-second shockproof memory (protection against skipping).
- CDs can be dubbed (copied) to SD cards and USB flash drives
- Direct folder function using the number (1–10/0) buttons on the main unit or the wireless remote control (SD card/USB flash drive)
- Browse function (SD card/USB flash drive)
- Folder erase function (SD card/USB flash drive)

Included items

This product includes the following items.

Take care when opening the package not to damage the items. Keep the packing materials for transportation in the future.

Please contact TASCAM if any of these items are missing or have been damaged during transportation.

- Main unit 1
- Wireless remote control unit (RC-CD200SB)..... 1
- AAA batteries 2
- A rack-mounting screw kit..... 1
- Warranty card 1
- Owner's Manual (this manual)..... 1

Conventions used in this manual

In this manual, we use the following conventions:

- Buttons, connectors and other parts of the unit and external devices are indicated like this: **SET** button
- Text displayed on the display of the unit and external devices appears like this: **ON**.
- CD-DA format discs are sometimes called “audio CDs.”
- CDs that contain audio files in MP2, MP3 or WAV formats are called “data CDs.”
- Audio CDs and data CDs are sometimes generically called “CDs”.
- SD/SDHC memory cards are called “SD cards”.
- MP3, MP2, WAV, WMA and AAC files are sometimes generically called “audio files”.
- The currently selected media is called the “current media”.
- The currently selected folder is called the “current folder”.
- The currently selected file is called the “current file”.
- Additional information is provided as necessary as tips, notes and cautions.

TIP

These are tips about how to use the unit.

NOTE

These provide additional explanations and describe special cases.

CAUTION

Failure to follow these instructions could result in injury, damage to equipment or lost recording data, for example.

1 – Introduction

Trademarks

- TASCAM is a registered trademark of TEAC Corporation.
- SDHC Logo is a trademark of SD-3C, LLC.



- Supply of this product does not convey a license nor imply any right to distribute MPEG Layer-3 compliant content created with this product in revenue-generating broadcast systems (terrestrial, satellite, cable and/or other distribution channels), streaming applications (via Internet, intranets and/or other networks), other content distribution systems (pay-audio or audio-on-demand applications and the like) or on physical media (compact discs, digital versatile discs, semiconductor chips, hard drives, memory cards and the like). An independent license for such use is required. For details, please visit <http://mp3licensing.com>.
- MPEG Layer-3 audio coding technology licensed from Fraunhofer IIS and Thomson.
- This product is protected by certain intellectual property rights of Microsoft. Use or distribution of such technology outside of this product is prohibited without a license from Microsoft.
- Other company names, product names and logos in this document are the trademarks or registered trademarks of their respective owners.

Precautions for placement

- The operating temperature should be between 5°C and 35°C (41°F and 95°F).
- Make sure that the unit is mounted in a level position for correct operation.
- Do not place any object on the unit for heat dissipation.
- Avoid installing this unit on top of any heat-generating electrical device such as a power amplifier.

Power supply

Connect the unit to the standard power outlet. Hold the plug when connecting and disconnecting the power cord.

Beware of condensation

If the unit is moved from a cold to a warm place, or used immediately after a cold room has been heated or otherwise exposed to a sudden temperature change, condensation could occur. Should this happen, leave the unit for one or two hours before turning the unit on.

Cleaning the unit

To clean the unit, wipe it gently with a soft dry cloth. Do not wipe with chemical cleaning cloths, paint thinner, ethyl alcohol or other chemical agents to clean the unit as they could damage the surface.

Once every five years, please contact the retailer where you purchased the unit or a TASCAM service center for internal cleaning. If the unit is not cleaned for a long time and dust is allowed to accumulate inside it, fire or malfunction could result. Cleaning is more effective when conducted before the humid season. Please check with us about the cost of internal cleaning.

SD cards and USB flash drives

This unit can use SD cards and USB flash drives for playback and dubbing.

A list of SD cards and USB flash drives that we have confirmed to operate with this unit is posted on the TASCAM website (<http://tascam.com/>)

Handling precautions

SD cards and USB flash drives are made with precision. In order to avoid damaging SD cards and USB flash drives, please observe the following precautions when handling them.

- Do not leave them in places that are extremely hot or cold.
- Do not leave them in places that are extremely humid.
- Do not get them wet.
- Do not place objects on top of them or twist them.
- Do not subject them to strong impacts.
- Do not remove or insert them during dubbing, playback or data transfer or at other times they are being accessed by the unit.
- When transporting them, do not leave their terminals exposed (use covers).

About media that have been confirmed for use with this unit

This unit uses SD cards and USB flash drives for playback and dubbing.

Old SD cards and USB flash drives, as well as some new ones, might have memory components with slow operating speeds or small internal buffering capacities. Use of such cards and drives could affect the dubbing performance of this unit.

Please refer to the list of SD cards and USB flash drives that we have confirmed to operate with this unit that is posted on the TASCAM website. You can also contact TASCAM customer support. (<http://tascam.com/>)

SD card/USB flash drive write-protection

This unit writes settings used by the direct folder function (page 32) to the media in order to save them. Since direct folders settings cannot be written to SD cards and USB flash drives that are write-protected, these settings will be lost when the media is removed and the power is turned OFF.

Precaution regarding use with Mac operating systems

The number of songs and track numbers within a folder might not match on SD cards and USB flash drives that have been written on by a Mac. This is an existing problem with Mac system files, but it will not affect playback on this unit.

If the "Trash" is not emptied on a Mac, the open space on an SD card or USB flash drive could be insufficient and dubbing and other operations might not be possible. Empty the Trash before ejecting an SD card or USB flash drive from a Mac.

About discs

In addition to audio CDs (CD-DA), the CD-200SB can play CD-R and CD-RW discs on which audio CD, MP3, MP2 or WAV format files are recorded. The CD player can also play 3-inch CDs

Handling of compact discs

- Always place the compact discs in the trays with their label facing upward.
- To remove a disc from its case, press down on the center of the disc holder, then lift the disc out, holding it carefully by the edges.
- Do not touch the signal side (the unlabeled side). Fingerprints, oils and other substances can cause errors during playing.
- To clean the signal side of a disc, wipe gently with a soft dry cloth from the center towards the outside edge. Dirt on discs can lower the sound quality, so clean them and always store them in a clean state.
- Do not use any record spray, anti-static solutions, benzene, paint thinner or other chemical agents to clean CDs. This could damage the delicate playing surface and cause CDs to become unplayable.
- Do not apply labels or other materials to discs. Do not use discs that have had tape, stickers or other materials applied to their surface. Do not use discs that have sticky residue from stickers, etc. Such discs could become stuck in the unit or cause it to malfunction.
- Never use a commercially available CD stabilizer. Using stabilizers with this unit will damage the mechanism and cause it to malfunction.
- Do not use cracked discs.
- Only use circular compact discs. Do not use non-circular promotional, etc. discs.

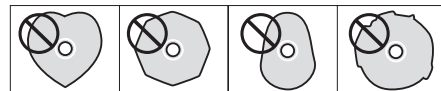

- Some record companies sell copy-protected discs or copy-controlled discs that may not play back correctly in this unit. Since such discs may not conform with the CD standard, do not use them in this unit.
- If you experience problems with such non-standard discs, you should contact the producers of the disc.

2 – Names and functions of parts

Top panel

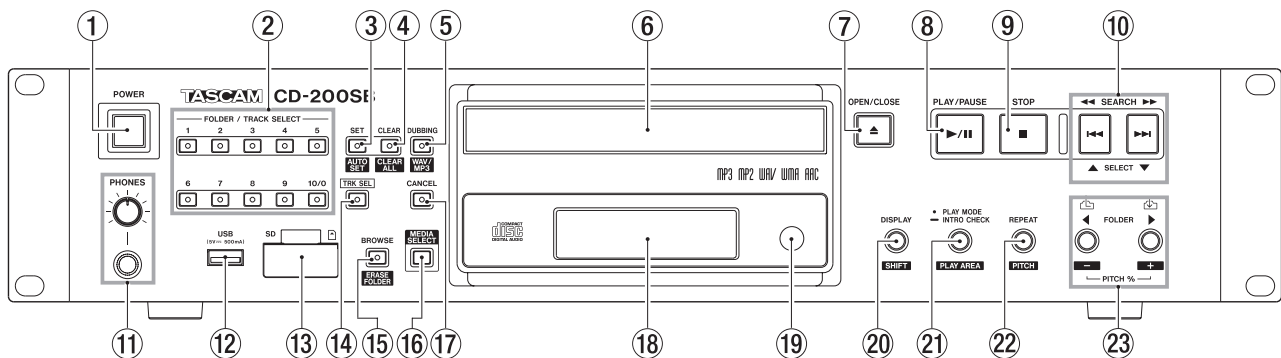

1 POWER switch

Press this switch to turn the unit on or off.

NOTE

- Before turning this unit's power ON/OFF, minimize the volume of monitoring systems connected to it.
- Do not wear headphones when turning the power ON/OFF. Noise could damage speakers or your hearing.

2 FOLDER/TRACK SELECT (1–10/0) buttons/indicators

When the **TRK SEL** indicator is not lit, these buttons can be used for the direct folder function. The indicators light on the buttons that have folders assigned for the direct folder function. (See "Assigning direct folders" on page 32.)

Press a button that has a lit indicator to begin playback of the folder that has been assigned using the direct folder function. During folder playback, the indicator blinks. (See "Direct folder playback" on page 35.)

When the **TRK SEL** indicator is lit, these buttons can be used as number (1–10/0) buttons to select track numbers on the current media. (See "Selecting by track number" on page 23.)

Track numbers have a maximum of two digits on audio CDs and a maximum of three digits on data CDs, SD cards and USB flash drives.

3 SET [AUTO SET] button/indicator

Use with the direct folder function to assign folders on an SD card or USB flash drive to **FOLDER/TRACK SELECT (1–10/0)** buttons. This indicator lights during assignment. (See "Assigning direct folders" on page 32.)

Press this button while pressing and holding the **DISPLAY [SHIFT]** button to automatically assign folders on the SD card/USB flash drive to the **FOLDER/TRACK SELECT (1–10/0)** buttons that have not yet been assigned. This indicator blinks when the direct folder AUTO SET function is in use. (See "Automatically assign all direct folders (AUTO SET)" on page 33.)

4 CLEAR [CLEAR ALL] button/indicator

Use with the direct folder function to clear **FOLDER/TRACK SELECT (1–10/0)** button folder assignments. This indicator lights while clearing an assignment. (See "Clearing individual direct folder assignments" on page 36.)

Press this button while pressing and holding the **DISPLAY [SHIFT]** button to clear all **FOLDER/TRACK SELECT (1–10/0)** buttons folder assignments. This indicator blinks while clearing all assignments. (See "Clearing all direct folder assignments (CLEAR ALL)" on page 37.)

5 DUBBING [WAV/MP3] button/indicator

Use when dubbing (copying) from a CD to an SD card or USB flash drive. This indicator lights while dubbing. (See "7 – Dubbing (copying)" on page 38.)

Press this button while pressing and holding the **DISPLAY [SHIFT]** button to show the current recording format setting used when dubbing for two seconds. Press this button again while pressing and holding the **DISPLAY [SHIFT]** button during this time to change the setting. (See "Dubbing" on page 39.)

6 Disc tray

Insert discs (CD, CD-R, CD-RW) here.

7 OPEN/CLOSE button

Use to open and close the disc tray.

8 PLAY/PAUSE button

Press during playback to pause. When playback is stopped or paused, press to start playback.

When in browse mode, use to confirm the selected track and to start playback.

9 STOP button

Press to stop playback.

While editing a program, press to clear all the program entries. (See "Setting the program" on page 25.)

10 SEARCH [LEFT/RIGHT] [1-LEFT/1-RIGHT], SELECT [UP/DOWN] buttons

When in browse mode, use these to change the selection. (See "5 – Browsing" on page 30.)

11 PHONES jack and knob

Use this standard stereo jack to connect stereo headphones. Use a plug adapter when connecting headphones with mini-plugs. Use the **PHONES** knob to adjust the headphone output level.

CAUTION

Use the **PHONES** knob to minimize the volume before connecting headphones. Failure to do so could cause a sudden burst of loud noise, which might result in hearing damage, for example.

2 – Names and functions of parts

12 USB port

Connect and disconnect USB flash drives here. (See “Connecting and disconnecting USB flash drives” on page 19.)

This unit can dub to USB flash drives and playback files on them.

13 SD card slot

Insert and remove SD cards here. (See “Inserting and removing SD cards” on page 18.)

This unit can dub to SD cards and playback files on them.

14 TRK SEL button/indicator

Press to light the **TRK SEL** indicator.

When this button's indicator is not lit, the **FOLDER/TRACK SELECT (1-10/0)** buttons can be used for the direct folder playback function. (See “Direct folder playback” on page 35.)

When this button's indicator is lit, the **FOLDER/TRACK SELECT (1-10/0)** buttons can be used as number **(1-10/0)** buttons to select tracks on the current media. (See “Selecting by track number” on page 23.)

15 BROWSE [ERASE FOLDER] button/indicator

Press to activate browse mode, which allows you to explore the folder structure of the current media.

When in browse mode, this indicator lights. (See “5 – Browsing” on page 30.)

Press this button while pressing and holding the **DISPLAY [SHIFT]** button to activate the folder erase mode in which you can erase folders on SD cards and USB flash drives.

When in folder erase mode, this indicator blinks. (See “Erasing folders” on page 42.)

16 MEDIA SELECT button

Set the current media to CD, SD card or USB flash drive.

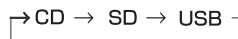

Cycle through the current media options

NOTE

You cannot select SD or USB if the corresponding media type is not loaded.

17 CANCEL button/indicator

When this indicator is lit or blinking, you can press this button to cancel the previous operation.

18 Display

Displays various information.

19 Remote Sensor

When operating the remote control unit (RC-CD200SB), point it towards here.

20 DISPLAY [SHIFT] button

You can change the time and other information shown on this display.

When this button is pressed, the type of information currently displayed is shown for two seconds. Press the button again during this time to change the type of information shown. The information that can be shown depends on the type of media and the status of operation. (See “Time and text information display” on page 27.)

Press this button at the same time as another button to use its shift function, which is shown as black letters on a white background beneath the button.

21 PLAY MODE / INTRO CHECK [PLAY AREA] button

Press briefly to change the playback mode.

The four playback modes are continuous, single, random and program. (See “Setting the playback area” on page 21.)

During playback or when stopped, press and hold this button to use the intro check playback feature. The beginning of each track on the CD plays for 10 seconds in order. During intro check playback, press and hold this button again to return to the previous playback mode and continue playing the current track. (See “Intro Check function” on page 29.)

Press this button while pressing and holding the **DISPLAY [SHIFT]** button to set the playback area during playback of data CDs, SD cards and USB flash drives to **ALL PLAY** or **FOLDER**. (See “Setting the playback area” on page 21.)

22 REPEAT [PITCH] button

Press to turn the repeat playback function ON/OFF.

While pressing and holding the **DISPLAY [SHIFT]** button, press this button to turn the CD playback pitch control function ON/OFF. (See “Pitch control (with CDs only)” on page 28.)

23 FOLDER ◀/▶ [PITCH - / +, ↗ / ↘]

Use these buttons when the playback area is set to **FOLDER** to change the playback folder. (See “Setting the playback folder” on page 24.)

Use these buttons when the playback area is set to **ALL PLAY** to skip between folders.

Press this button while pressing and holding the **DISPLAY [SHIFT]** button to set the pitch control value. (See “Pitch control (with CDs only)” on page 28.)

When in browse mode, press the **FOLDER ◀ [PITCH -, ↗]** button to move to the folder one level higher (parent), and press the **FOLDER ▶ [PITCH +, ↘]** button to enter the currently selected folder. (See “5 – Browsing” on page 30.)

2 – Names and functions of parts

Rear panel

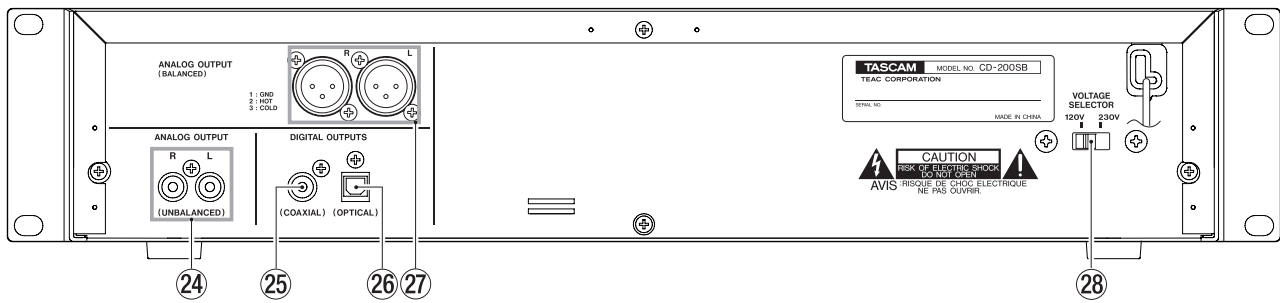

24 ANALOG OUTPUT (UNBALANCED) jacks

These jacks output analog signals (–10 dBV) of the CD, SD card or USB flash drive playback sound signal.

25 DIGITAL OUTPUTS (COAXIAL) jack

This jack outputs the CD, SD card or USB flash drive playback signal in S/PDIF digital format.

26 DIGITAL OUTPUTS (OPTICAL) jack

This jack outputs the CD, SD card or USB flash drive playback signal in S/PDIF digital format.

NOTE

- The sampling frequency of this unit's digital output is always 44.1 kHz regardless of the playback media/file sampling frequency.
- Digital output is possible when the pitch control function is on with Audio CD or Data CD, but the sampling frequency is changed by an amount proportional to the pitch control value.

27 ANALOG OUT (BALANCED) connectors

These balanced analog connectors output the playback signals from CDs, SD cards and USB flash drives.

The maximum output level is +20 dBu (1: GND, 2: HOT, 3: COLD).

28 VOLTAGE SELECTOR

Switches the voltage to either 230 V or 120 V.

NOTE

- The voltage selector is only available on units for specific markets.
- In North America, use only on 120V supply.

2 – Names and functions of parts

Display

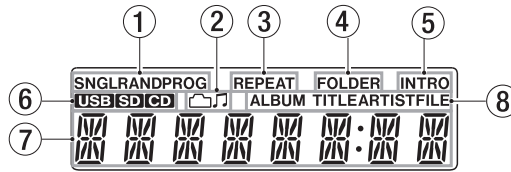

① **Playback mode indicator**

This shows the current playback mode.

Indicator	Playback mode
None	Continuous playback mode
SNGL	Single playback mode
RAND	Random playback mode
PROG	Program playback mode

② **Folder/audio file indicator**

When in browse mode, this shows the selected data type.

Indicator	Meaning
	Folder selected
	Audio file selected

③ **REPEAT indicator**

REPEAT appears when the repeat playback function is ON.

④ **FOLDER indicator**

FOLDER appears when the playback area is set to FOLDER.

⑤ **INTRO indicator**

INTRO appears when the intro check function is ON.

⑥ **Current media indicator**

This shows the currently selected media type.

⑦ **Main display area**

The track number and time or text information is shown. The status of the unit (OPEN, CLOSE, TOC* READ, etc.) and messages (NO DISC, etc.) are also shown. Items with more than eight characters are scrolled when shown.

* TOC means "Table Of Contents," which is track information written on the disc

⑧ **Main display information type indicator**

When text information is shown in the main display area, these indicate the type of information.

Indicator	Meaning
ALBUM TITLE	CD-TEXT album title or current folder name
ALBUM ARTIST	CD-TEXT album artist
TITLE	CD-TEXT track title or track title of the current file (from its tag data)
ARTIST	CD-TEXT track artist or track artist of the current file (from its tag data)
FILE	Current file name

2 – Names and functions of parts

Remote control unit (TASCAM RC-CD200SB)

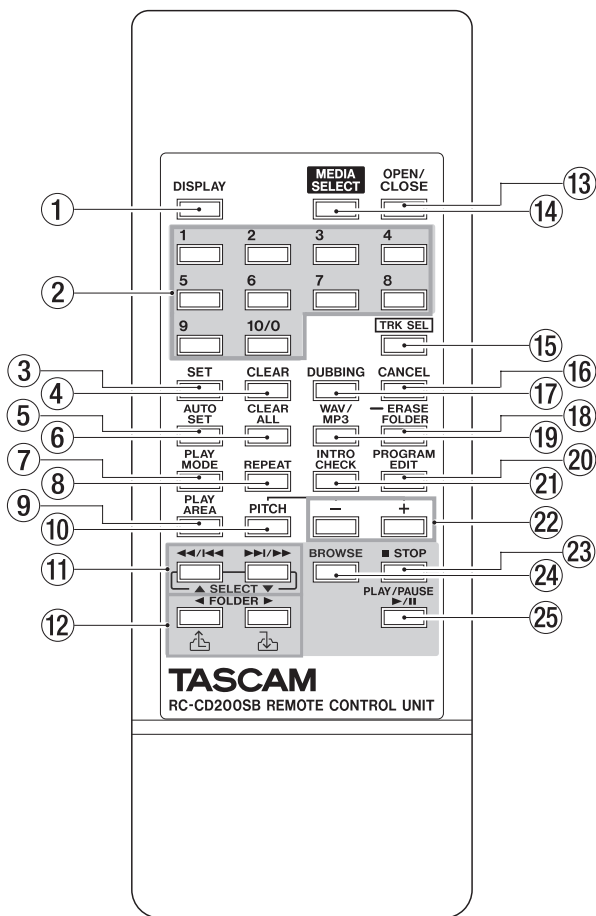

① DISPLAY button

Press to change how the time is shown and other information. When this button is pressed, the type of information currently displayed is shown for two seconds. Press the button again during this time to change the type of information shown. The information that can be shown depends on the type of media and the status of operation. (See "Time and text information display" on page 27.)

② Number (1–10/0) buttons

When the **TRK SEL** indicator on the main unit is not lit, these buttons can be used for the direct folder function. (See "Assigning direct folders" on page 32.)

Press the same number button as a lit **FOLDER/TRACK SELECT (1–10/0)** indicator on the main unit to begin playback of the folder that has been assigned using the direct folder function. During folder playback, that indicator blinks. (See "Direct folder playback" on page 35.)

When the **TRK SEL** indicator on the main unit is lit, these buttons can be used as number (1–10/0) buttons to select track numbers on the current media. (See "Selecting by track number" on page 23.)

Track numbers have a maximum of two digits on audio CDs and a maximum of three digits on data CDs, SD cards and USB flash drives.

③ SET button

Use with the direct folder function to assign folders on an SD card or USB flash drive to **FOLDER/TRACK SELECT (1–10/0)** buttons. (See "Assigning direct folders" on page 32.)

④ CLEAR button

Use with the direct folder function to clear **FOLDER/TRACK SELECT (1–10/0)** button folder assignments. (See "Clearing individual direct folder assignments" on page 36.)

⑤ AUTO SET button

Press to automatically assign folders on the SD card/USB flash drive to the **FOLDER/TRACK SELECT (1–10/0)** buttons that have not yet been assigned. (See "Automatically assign all direct folders (AUTO SET)" on page 33.)

⑥ CLEAR ALL button

Press to clear all **FOLDER/TRACK SELECT (1–10/0)** buttons folder assignments. (See "Clearing all direct folder assignments (CLEAR ALL)" on page 37.)

⑦ PLAY MODE button

Press to change the playback mode.

The four playback modes are continuous, single, random and program. (See "Playback modes" on page 21.)

⑧ REPEAT button

Press to turn the repeat playback function ON/OFF. (See "Repeat playback" on page 27.)

⑨ PLAY AREA button

Press to set the playback area during playback of data CDs, SD cards and USB flash drives to **ALL PLAY** or **FOLDER**. (See "Setting the playback area" on page 21.)

⑩ PITCH button

Press this button to turn the CD playback pitch control function ON/OFF. (See "Pitch control (with CDs only)" on page 28.)

⑪ ◀◀/▶▶ and ▶▶/▶▶, [SELECT ▲/▼] buttons

Press briefly to select tracks (skip). Press and hold to search a track.

When in browse mode, use these to change the selection. (See "5 – Browsing" on page 30.)

⑫ FOLDER ◀▶ [▲/▼] buttons

Use these buttons when the playback area is set to **FOLDER** to change the playback folder. (See "Setting the playback folder" on page 24.)

Use these buttons when the playback area is set to **ALL PLAY** to skip between folders.

When in browse mode, press the **FOLDER ◀ [▲]** button to move to the folder one level higher (parent), and press the **FOLDER ▶ [▼]** button to enter the currently selected folder. (See "5 – Browsing" on page 30.)

2 – Names and functions of parts

- ⑬ **OPEN/CLOSE button**
Use to open and close the disc tray.
- ⑭ **MEDIA SELECT button**
Set the current media to CD, SD card or USB flash drive.



Cycle through the current media options

NOTE

You cannot select SD or USB if the corresponding media type is not loaded.

- ⑮ **TRK SEL button**
Press to light the **TRK SEL** indicator on the main unit.
When the **TRK SEL** indicator on the main unit is not lit, the **FOLDER/TRACK SELECT (1–10/0)** buttons can be used for the direct folder playback function. (See “Direct folder playback” on page 35.)
When the **TRK SEL** indicator on the main unit is lit, the **FOLDER/TRACK SELECT (1–10/0)** buttons can be used as number **(1–10/0)** buttons to select tracks on the current media. (See “Selecting by track number” on page 23.)
- ⑯ **CANCEL button**
When the **CANCEL** indicator on the main unit is lit or blinking, you can press this button to cancel the previous operation.
- ⑰ **DUBBING button**
Use when dubbing (copying) from a CD to an SD card or USB flash drive. (See “7 – Dubbing (copying)” on page 38.)
- ⑱ **ERASE FOLDER button**
Press to activate the folder erase mode in which you can erase folders on SD cards and USB flash drives. (See “Erasing folders” on page 42.)
- ⑲ **WAV/MP3 button**
Press when dubbing to change the recording format. (See “Dubbing” on page 39.)
- ⑳ **PROGRAM EDIT button**
Use to set, confirm and edit programs. (See “Programmed playback” on page 24.)
- ㉑ **INTRO CHECK button**
Use for intro check playback. The first 10 seconds at the beginnings of tracks on the current media will be played back one after another.
During intro check playback, press and hold this button again to return to ordinary playback mode. (See “Intro Check function” on page 29.)
- ㉒ **–/+ buttons**
Use these adjust the pitch control value during CD playback. (See “Pitch control (with CDs only)” on page 28.)
- ㉓ **STOP button**
Press to stop playback.
While editing a program, press to clear all the program entries. (See “Setting the program” on page 25.)
- ㉔ **BROWSE button**
Press to activate browse mode, which allows you to explore the folder structure of the current media. (See “5 – Browsing” on page 30.)
- ㉕ **PLAY/PAUSE button**
Press during playback to pause. When playback is stopped or paused, press to start playback.
When in browse mode, use to confirm the selected track and to start playback.

3 – Preparations

Making connections

Examples of connections that can be made with a CD-200SB are shown below.

■ Precautions before making connections

- Before connecting other devices, read their operation manuals carefully and connect them properly.
- Turn the power OFF or set the power to standby for this unit and all units to be connected to it.
- Set up all the units so that they are powered from the same line. When using a power strip, for example, use a thick cable with a high current capacity to reduce fluctuation of the power voltage.

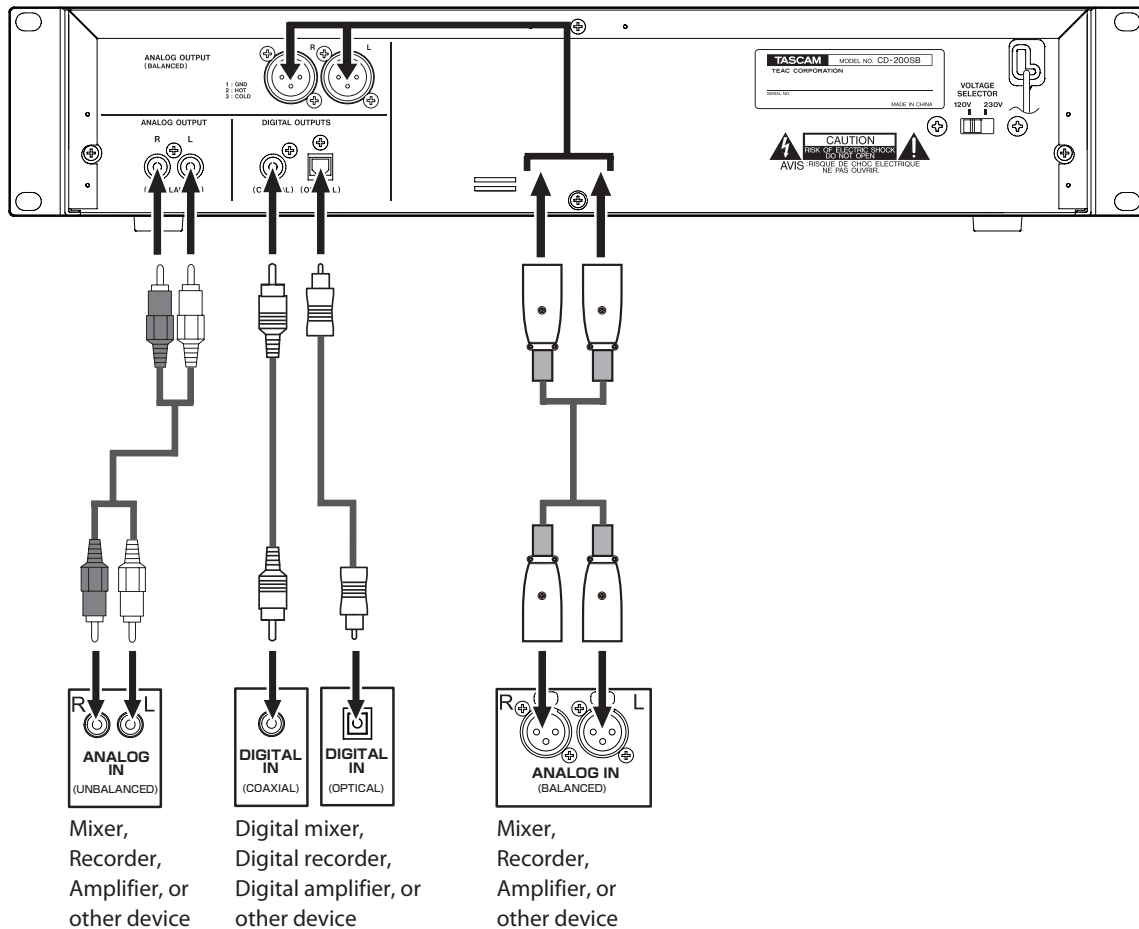

■ Connecting analog audio devices

Connect the analog output jacks of this unit to the input jacks of a stereo amplifier, mixer, recorder or other device with analog inputs.

NOTE

- Cables are not included with this unit.
- Do not bundle RCA cables with power cords or speaker cables. Doing so could cause reduced audio quality or noise.

■ Connecting digital audio devices

Connect a digital output jack (coaxial or optical) of this unit to the input jack of a stereo amplifier, mixer, recorder or other device with a digital input.

NOTE

- The sampling frequency of this unit's digital output is always 44.1 kHz regardless of the playback media/file sampling frequency.
- During playback of audio CD, digital output is possible when the pitch control function is in use, but the sampling frequency is changed by an amount equivalent to the pitch control value. When the pitch control function is on, some devices might not be able to accept signals from the digital outputs of this unit.

Preparing the remote control

Inserting batteries

1. Open the lid.

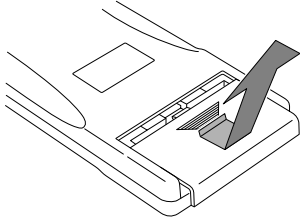

2. Confirm +/- polarity, and insert two AA batteries.

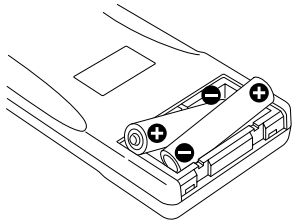

3. Close the lid.

Replacing the batteries

Replace both batteries with new ones when the range of the remote control becomes short or if the function buttons become unresponsive.

Cautions about the use of batteries

Misuse of batteries could cause them to leak, rupture or otherwise be damaged. Please read and abide by the precautions on them when using batteries. Also see "CAUTIONS ABOUT BATTERIES" on page 4.

Cautions about using the remote control

- When using other devices controlled by infrared rays, use of this remote control might operate these devices by mistake.
- Use the remote control within the following range.

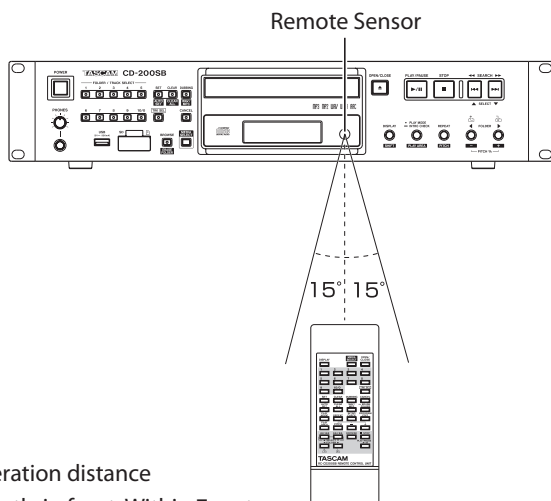

Operation distance

Directly in front: Within 7 meters

15° left or right: Within 7 meters

Loading a CD

To load a CD, press the **OPEN/CLOSE** button on the main unit or on the remote control to open the disc tray, and put the CD into the tray with the label facing up.

Press the **OPEN/CLOSE** button again to close the disc tray. After loading the disc, the unit reads the disc's information and the display shows the total number of tracks and total playback time if it is an audio CD or the total number of tracks in the current folder or on the entire disc if it is a data CD.

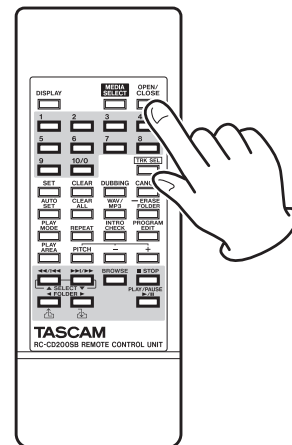
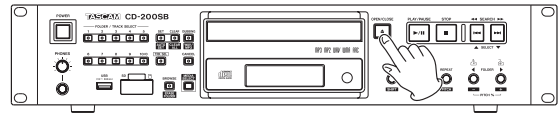

NOTE

- When the current media is set to CD, instead of pressing the **OPEN/CLOSE** button to close the disc tray, you can press the **PLAY/PAUSE** button to close the disc tray and begin playback immediately.
- If you open the disc tray while this unit is in use, the following settings are lost.
 - Program
 - Current folder (for data CDs)

3 – Preparations

Inserting and removing SD cards

Inserting SD cards

To use an SD card with this unit for playback/dubbing, insert the SD card into the SD card slot on the front panel.

NOTE

You can insert an SD card regardless of whether the power is ON or OFF.

1. Pull the SD card slot cover forward to open it.

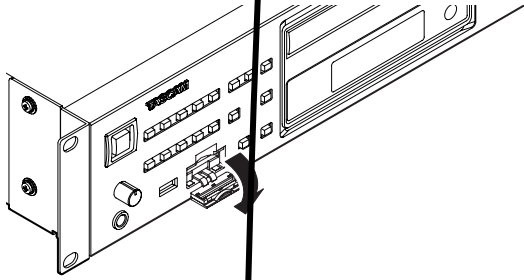

2. Insert the SD card with the correct orientation. The label side should be up and the connector end should be inserted first.

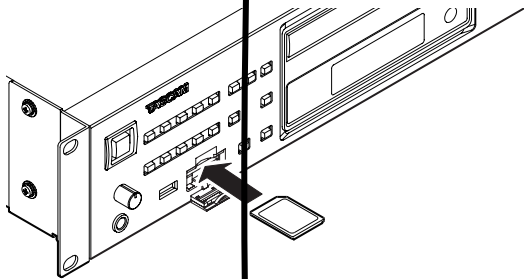

3. Close the card slot cover.

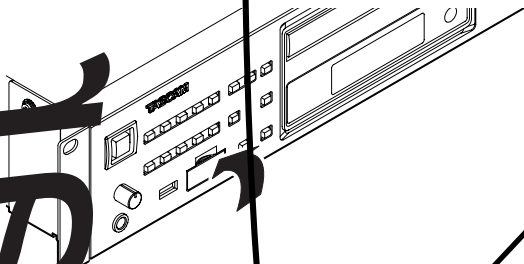

NOTE

If the SD card slot cover will not close, remove the SD card once and then reinsert it.

Removing SD cards

Turn the power OFF or stop operation before removing an SD card.

CAUTION

Never remove an SD card when this unit is operating (playing back, writing data to the SD card, etc.). Doing so could, for example, cause dubbing to fail, data to be lost or sudden loud noises from monitoring equipment, which might damage the equipment or harm your hearing.

1. Pull the SD card slot cover forward to open it.
2. Press the SD card in gently to make it eject partially.



Connecting and disconnecting USB flash drives

Connecting USB flash drives

To use a USB flash drive with this unit for playback and dubbing, insert it into the USB port.

NOTE

You can insert a USB flash drive anytime regardless of whether the power is ON or OFF.

Disconnecting USB flash drives

Turn the power OFF or stop operation before disconnecting a USB flash drive.

CAUTION

Never remove a USB flash drive when this unit is operating (playing back, writing data to the USB flash drive, etc.). Doing so could, for example, cause dubbing to fail, data to be lost or sudden loud noises from monitoring equipment, which might damage the equipment or harm your hearing.

Selecting the playback media

Press the **MEDIA SELECT** button on the main unit or the remote control to select the media played back by the main unit.

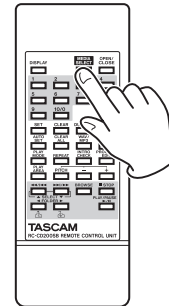
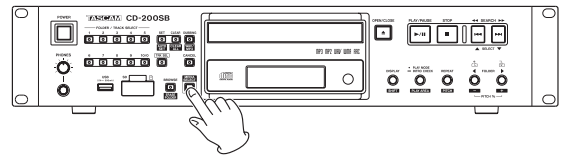

Cycle through the current media options in the following order.



The icon for the selected current media (**CD** / **SD** / **USB**) is shown in the current media indicator area of the display.

NOTE

- The **SD** / **USB** icons will not appear if the corresponding media has not been loaded (they cannot be selected).
- Whenever the current media type is changed, the previously selected media will stop if it was playing back or paused. (For example, when the current media is changed from CD to another type of media, the CD will stop if it was playing back or paused.)
- Even if the current media is changed, the playback mode setting, current folder and program contents will not be erased.

4 – Playback

In this chapter, we explain playback functions that can be used with tracks on audio CDs and audio files on data CDs, SD cards and USB flash drives.

The following explanations assume that a CD, SD card or USB flash drive that contains audio files/tracks has been loaded in this unit, the power is ON and the current media has been selected appropriately. (See “Selecting the playback media” on page 19.)

Playable media and files

This unit can play back the following types of media and files.

■ CD-DA (audio CD) format discs

Music CDs that are commercially available and CD-R and CD-RW discs that have been recorded as audio CD format can be played. In this manual, these types of discs are called “audio CDs.”

■ Data CDs

This unit can play back CD-ROM/R/RW discs with MP3, MP2 and WAV files in ISO 9660 Level 1, Level 2 and Joliet formats. In this manual, these types of discs are called, “data CDs.”

NOTE

This unit cannot read CD-R discs that have not been finalized.

■ SD cards and USB flash drives

In addition to files (WAV, MP3) dubbed using this unit, this unit can also play back audio files that have been recorded by other devices or written using a computer or another audio device if they are in the following formats.

Playable file types and their file extensions

AAC	.3gp .m4a .mp4
MP2	.mp2
MP3	.mp3
WAV	.wav
WMA	.asf .wma

NOTE

- For details about playable sampling frequencies and bit rates, see “Playback file formats” on page 46.
- The sampling frequency of this unit’s digital output is always 44.1 kHz regardless of the playback media/file sampling frequency. Digital output is possible when pitch control is ON, but the sampling frequency is altered in proportion to the pitch control value. When the pitch control function is ON, therefore, some equipment might not be able to receive the digital output of this unit.
- This unit’s display can only show single-byte characters (alphabet and numbers). File with names that use Japanese, Chinese or other double-byte characters can be played back, but those characters will be shown as _ on the display.
- This unit identifies MP3 and MP2 files by their “.mp3” and “.mp2” file extensions. This unit cannot play MP3/MP2 files that do not have the correct “.mp3” and “.mp2” file extension, so always include these file extensions at the ends of MP3/MP2 file names. This unit cannot play files that are not in the MP3/MP2 data format even if they have an “.mp3” and “.mp2” file extension.
- The unit identifies WAV files with the “.wav” file extension. This unit cannot play WAV files that do not have the “.wav” file extension, so always include the “.wav” file extension at the end of the name of an WAV file. The unit cannot play files that are not in the WAV data format even if they have the “.wav” file extension.

- Data CDs with more than 999 files or 513 folders might not play correctly.
- Depending on disc conditions, this unit might not be able to play some discs, or skips in the sound might occur.

Folders and tracks on data CDs, SD cards and USB flash drives

This unit treats all the audio files on data CDs, SD cards and USB flash drives as “tracks”. Some data CDs store files inside folders in the same way that computers usually do. In addition, multiple folders can be stored inside another folder creating a multilevel structure. (The maximum number of folder levels is 16.)

You can use this unit’s folder search function to look for audio files among multiple folders. Searching starts from high-level folders and then moves to lower-level subfolders.

If there are audio files in the root directory of a data CD, this root directory is also treated as a folder.

Folders that do not directly contain audio files will be ignored when searching folders. For example, folders C and D in the illustration below would be ignored when searching folders.

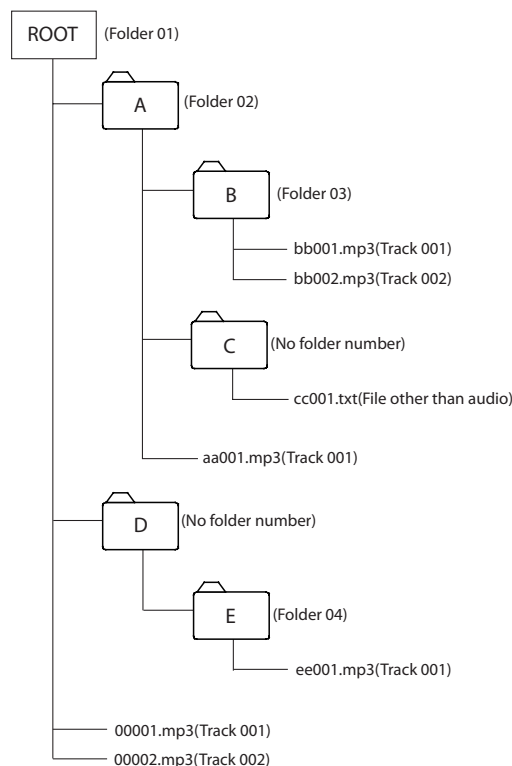

Example of a folder and file structure of a data CD, SD card or USB flash drive

Playback area

You can set the area to be used for playback (PLAY AREA setting). Follow the procedures below to set the playback area.

Setting the playback area

While pressing and holding the main unit **DISPLAY [SHIFT]** button, press the **PLAY MODE/INTRO CHECK [PLAY AREA]** button, or press the remote control **PLAY AREA** button to set the playback area.

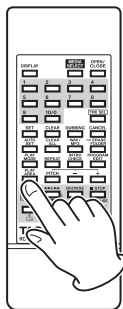
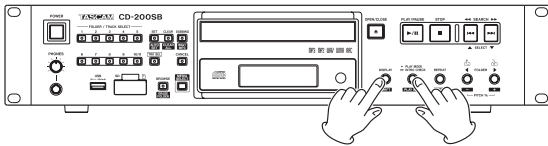

The selected playback area is shown as follows in the main display area for about two seconds and then disappears. Depending on the selected playback area, the **FOLDER** indicator might also appear on the display.

Main display area	FOLDER indicator	Meaning
ALL PLAY	Not shown	All files on the current media will be played back.
FOLDER	Shown	All files in the selected folder on the current media will be played back.

Playback modes

This unit can play back tracks using the following four playback modes.

Continuous playback mode (default setting)

Tracks on the current media are played back in numerical order.

NOTE

*When the current media is a CD, SD card or USB flash drive and the playback area is set to **FOLDER**, tracks in the current folder are played back in numerical order.*

Single playback mode

The selected track on the current media is played back once and then playback stops.

Random playback mode

The tracks on the current media are played back in random order regardless of their track numbers. Playback stops after all tracks have been played.

NOTE

- *When the current media is a CD, SD card or USB flash drive and the playback area is set to **FOLDER**, tracks in the current folder are played back randomly. (See “Folder playback (data CDs/SD cards/USB flash drives)” on page 24.)*
- *A maximum of 65535 tracks can be played back randomly from an SD card or USB flash drive. If the playback area is **ALL PLAY** and there are more than 65535 tracks in the playback area, tracks numbered higher than 65535 will not be played back.*

Program playback mode

The programmed tracks are played back in program order. See “Programmed playback” on page 24 for details.

4 – Playback

Selecting the playback mode

Press the main unit **PLAY MODE/INTRO CHECK [PLAY AREA]** button or the remote **PLAY MODE** button to cycle through the playback modes. During playback, however, you can only switch among continuous, single and random playback modes.

To select programmed playback, press the main unit **PLAY MODE/INTRO CHECK [PLAY AREA]** button or the remote **PLAY MODE** button when playback is stopped.

The currently selected playback mode is shown on the display as follows.

Indicator	Playback mode
No indicator	Continuous playback mode
SNGL	Single playback mode
RAND	Random playback mode
PROG	Program playback mode

The selected playback mode is retained even when the power is turned off.

NOTE

*Immediately after pressing the **PLAY MODE/INTRO CHECK [PLAY AREA]** button on the main unit or the **PLAY MODE** button on the remote control, the selected mode is shown on the main display area as follows.*

- Continuous playback mode set:* CONTINUE
- Single playback mode set:* SINGLE
- Random playback mode set:* RANDOM
- Programmed playback mode set:* PROGRAM

Playback

The following procedures assume that the necessary connections have been completed, the unit's power has been turned ON and the media has been loaded.

To start playback, press the **PLAY/PAUSE** button on the main unit or the remote control.

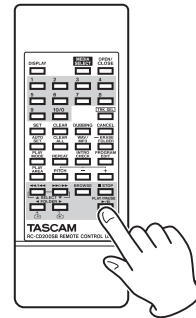
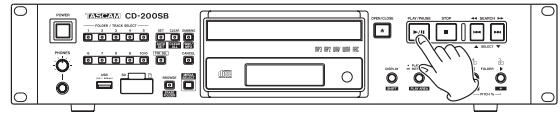

■ Stopping playback

Press the **STOP** button on the main unit or the remote control.

■ Pausing playback

Press the **PLAY/PAUSE** button on the main unit or the remote control.

In this manual, unless stated otherwise, explanations are given assuming that the playback mode is continuous. (See "Playback modes" on page 21.)

Selecting a track

There are two ways to select a track. You can move (skip) to the previous or next track, or you can select a track directly by its track number.

Skipping to the next or previous track

Use the main unit **SEARCH** ◀▶/▶▶ [▶▶▶/▶▶▶], **SELECT** ▲/▼] buttons or the remote search (◀◀/▶▶ [SELECT ▲] and ▶▶▶/▶▶▶ [SELECT ▼]) buttons to skip to tracks.

After selecting the track, press the **PLAY/PAUSE** button on the main unit or the remote control to start track playback.

NOTE

If you press the main unit **SEARCH** ◀▶/▶▶ [▶▶▶/▶▶▶], **SELECT** ▲/▼] buttons or the remote search (◀◀/▶▶ [SELECT ▲] and ▶▶▶/▶▶▶ [SELECT ▼]) buttons during playback, playback will resume after skipping tracks.

Selecting by track number

You can select tracks directly for playback by number. After pressing the **TRK SEL** button on the main unit or the remote control to light the **TRK SEL** indicator, use the number (1–10/0) buttons on the main unit or the remote control to select tracks.

Track numbers can have up to two digits for audio CDs and up to three digits for data CDs, SD cards and USB flash drives.

1. Press the **TRK SEL** button on the main unit or the remote control to light the **TRK SEL** indicator on the main unit.
2. Use the main unit **FOLDER/TRACK SELECT (1–10/0)** buttons or the remote number (1–10/0) buttons to input the track number. Enter the track number starting from the largest digit.

To select track 1:

Press the **1** button one time.

To select track 12:

Press the **1** button followed by the **2** button.

3. Press the **PLAY/PAUSE** button on the main unit or the remote control. The selected track begins to play. If you press the **STOP** button on the main unit or the remote control, the display stops showing the track number input and the display returns to its previous state.

NOTE

- The highest track number that can be shown during playback is 999. --- will appear for track numbers higher than 999.
- When the playback area is set to ALL PLAY, use the **FOLDER** ◀/▶ buttons on the main unit or the remote control to skip between folders.
- When in program or random mode, you cannot use the number (1–10/0) buttons to select tracks.
- To use the main unit **FOLDER/TRACK SELECT (1–10/0)** buttons or the remote number (1–10/0) buttons for direct folder selection, press the **TRK SEL** button on the main unit or the remote control to make the main unit **TRK SEL** indicator unlit.

Search forward and backward

You can search forward and backward in a track while listening to it.

1. Play or pause the desired track.
2. Press and hold a **SEARCH** ◀◀/▶▶ [▶▶▶/▶▶▶], **SELECT** ▲/▼] button on the main unit or a search (◀◀/▶▶ [SELECT ▲] or ▶▶▶/▶▶▶ [SELECT ▼]) button on the remote control to start searching forward or backward.
3. Release the button that you are holding to stop searching and return the unit to the state it was in before searching (playback or pause).

NOTE

Audio files on data CDs, SD cards and USB flash drives can also be searched forward and backward.

4 – Playback

Folder playback (data CDs/SD cards/USB flash drives)

With data CDs, SD cards and USB flash drives, you can set the selected folder (current folder) as the playback area. Follow the procedures below to set the playback folder. You can also set the playback area to be all the tracks/files on the current media by selecting **ALL PLAY**.

Setting the playback folder

1. While pressing and holding the main unit **DISPLAY [SHIFT]** button, press the **PLAY MODE/INTRO CHECK [PLAY AREA]** button (or press the remote **PLAY AREA** button) to set the playback area to **FOLDER**.
2. Use the main unit **FOLDER ◀/▶ [PITCH -/+]**, **[↑/↓]** buttons or the remote **FOLDER ◀/▶ [↑/↓]** buttons to skip to the previous or next folder.
This will skip to the beginning of the first track in the previous or next folder. If you hold down one of these buttons, you can skip through folders continuously in order.

NOTE

- When you skip to a different folder, it becomes the current folder.
- During folder playback, repeat playback will play back all tracks inside the current folder repeatedly.
- During folder playback, random playback will play back all tracks inside the current folder randomly.

Programmed playback

To use programmed playback, you must set a program either before or after setting the playback mode to programmed playback mode. (See “Selecting the playback mode” on page 22.)

When in programmed playback mode, press the **PLAY/PAUSE** button on the main unit or the remote control to start playback of the set program in order from the first track (program step 01).

Press the main unit **SEARCH ◀◀/▶▶ [I◀◀/▶▶I, SELECT ▲/▼]** button or the remote search (**◀◀/I◀◀ [SELECT ▲]** or **▶▶/▶▶ [SELECT ▼]**) button to skip to the previous or next program step.

When playback is stopped in program playback mode using an audio CD, the total number of tracks in the program and the total program time are shown.

When using a data CD, only the program number is shown.

When using an SD card or USB flash drive, the number and time of the track being played back are shown.

NOTE

- To select programmed playback, when stopped, press the main unit **PLAY MODE/INTRO CHECK [PLAY AREA]** button or the remote **PLAY MODE** button.
- When using a data CD, SD card or USB flash drive, you cannot set a program when the playback area is **ALL PLAY**. Change the playback area to **FOLDER** to enable tracks in the current folder to be used in the program.

Setting the program

When no program is set, follow the procedures below to set a program using the remote control.

You can set programs independently for each type of media (CD/SD card/USB flash drive).

NOTE

- The program cannot be set from the main unit.
- You can set a program at any time regardless of the current playback mode.
- The maximum number of tracks that can be programmed with data CDs, SD cards and USB flash drives is 999.
- CD programs are cleared when the disc tray is opened or the current folder is changed.
- SD card and USB flash drive programs are cleared when the media is disconnected. Programs are also cleared when the dubbing (copying) or folder erase function is used, when the current folder is changed and when direct folder playback is used in program playback mode (PROG indicator appears).

1. Press the remote **PROGRAM EDIT** button when playback is stopped.

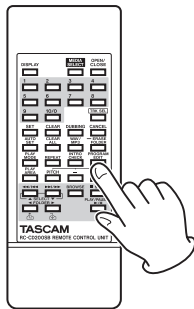

The unit enters program setting mode. If no program has been set, it will be possible to choose a track for program step 01 (PROG indicator blinks).



Audio CD example

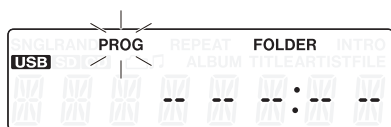

USB flash drive example

NOTE

If the program is already set, the track number of the track set as program step 01 is shown.

2. Use the remote number (1–10/0) buttons or search (◀◀/▶▶ [SELECT ▲] and ▶▶/▶▶ [SELECT ▼]) buttons to select a track to set as program step 01 (PROG and the track number blink). Use the number (1–10/0) buttons to input the number starting with the largest digit.

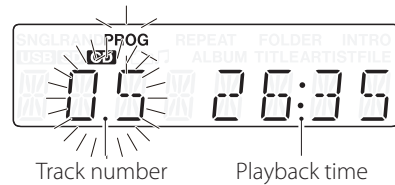

Track number Playback time

Audio CD example

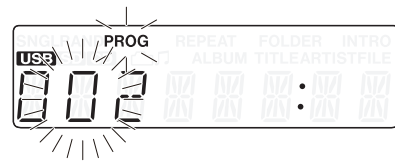

USB flash drive example

NOTE

- When using a data CD, SD card or USB flash drive, the screen switches to file name display if more than a second passes after pressing one of the remote number (1–10/0) or search (◀◀/▶▶ [SELECT ▲] and ▶▶/▶▶ [SELECT ▼]) buttons, but you can still add the track to the program.
- If you press the **STOP** button while a track is selected, selection of that track is canceled, and the screen returns to the state where you can select a track.

3. Press the remote **PROGRAM EDIT** button to add the selected track as program step 1.



4. The unit is now ready for you to add another track as the next program step.
5. If you are finished adding tracks to the program, press the remote **PROGRAM EDIT** button when the empty program step is shown. The unit exits program setting mode.

NOTE

- The same track can be added to the program multiple times.
- If you press the **STOP** button when the empty program step where it is possible to add a track appears, all steps in the program are cleared.
- If you try to add more than 99 tracks, a PGM FULL error message appears. Only 99 tracks can be added.

4 – Playback

Checking the program

You can check the contents of the program.

1. Press the **PROGRAM EDIT** button on the remote control while playback is stopped to put the unit into program setting mode. The track number and playback time of the track set as program step 01 is shown on the screen and **PROG** blinks. (Playback time is not displayed when using a data CD, SD card or USB flash drive.)

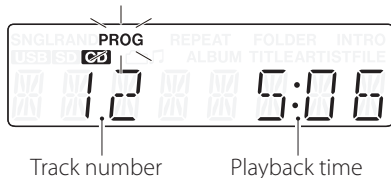

2. Press the **PROGRAM EDIT** button to show the track information of the next program step.



3. If you press the **PROGRAM EDIT** button when the final program step is shown, it becomes possible to add another program step. (No track number is shown and **PROG** blinks.)



4. Press the **PROGRAM EDIT** button again to exit the program setting mode.

Replacing a program track

You can replace a track that has already been added to the program.

1. Press the **PROGRAM EDIT** button on the remote control while playback is stopped to put the unit into program mode.
2. Follow the steps in “Checking the program” above and press the **PROGRAM EDIT** button to show the program step with the track that you want to replace.
3. Use the remote number (1–10/0) buttons or skip (◀◀/▶▶ [SELECT ▲] and ▶▶/▶▶ [SELECT ▼]) buttons to select the desired track and press the **PROGRAM EDIT** button. After replacing a track, the display shows the empty step at the end of the program and you can add another track to the end of the program if desired.
4. Press the **PROGRAM EDIT** button again to exit program setting mode.

Adding more program tracks

You can add tracks to the end of an already set program.

1. Press the **PROGRAM EDIT** button on the remote control while playback is stopped to activate program setting mode.
2. Press and hold the **PROGRAM EDIT** button until the empty program step where it is possible to add a track appears. (No track number is shown and **PROG** blinks.)
3. Use the remote number (1–10/0) buttons or skip (◀◀/▶▶ [SELECT ▲] and ▶▶/▶▶ [SELECT ▼]) buttons to select the track to add and press the **PROGRAM EDIT** button.
4. In this state, you can repeat step 3 to add more tracks, or you can press the **PROGRAM EDIT** button to exit program setting mode.

CAUTION

- Although tracks can be added to the end of a program and tracks can be replaced with different tracks, tracks cannot be inserted into the middle of a program.
- If you want to insert a track into the middle of the program, replace and add program tracks to alter the program contents.

Clearing the program

You can clear the entire program that has been set.

1. Press the **PROGRAM EDIT** button on the remote control while playback is stopped to activate program setting mode.
2. Press and hold the **PROGRAM EDIT** button until the empty program step where it is possible to add a track appears. (No track number is shown and **PROG** blinks.)
3. Press the remote **STOP** button. **–CLEAR–** appears on the display. After clearing completes, program setting mode resumes with the empty program.



In addition to the above procedure, opening the disc tray or removing the media also clears the program.

NOTE

- CD programs are cleared when the disc tray is opened or the current folder is changed.
- SD card and USB flash drive programs are cleared when the media is disconnected. Programs are also cleared when the dubbing (copying) or folder erase function is used, when the current folder is changed and when direct folder playback is used in program playback mode (**PROG** indicator appears).

Repeat playback

You can play back all the tracks in the playback area repeatedly. Press the main unit **REPEAT [PITCH]** button or the remote **REPEAT** button to turn the repeat playback function ON/OFF.

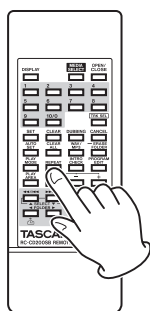
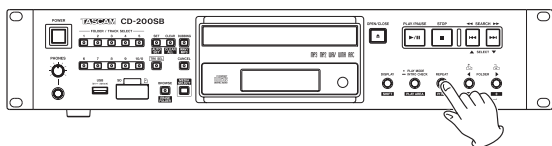

Repeat ON (REPEAT indicator appears)

All tracks are played back repeatedly.



Repeat OFF (no indicator)

Repeat playback is OFF.



NOTE

- With data CDs, SD cards and USB flash drives, during folder playback all tracks within the current folder will be played back repeatedly. During program playback, all tracks within the program will be played back repeatedly.
- If the repeat playback function is turned ON during playback, playback continues as is until the end and then playback continues from the beginning.
- If repeat playback is turned ON when stopped, repeat playback begins when the **PLAY/PAUSE** button is pushed.
- The repeat playback function's ON/OFF state is retained even when the power is turned OFF.

Time and text information display

You can set what type of time and text information is shown on the display.

Press the **DISPLAY [SHIFT]** button on the main unit or the **DISPLAY** button on the remote control to show for two seconds the type of information (playback time or text information) that is currently set to appear in the main area of the display. Press this button again while this is being shown to change the type of information displayed.

The types of data that can be shown when changing the display depend on the type and status of the current media or loaded disc, as well as this unit's operation status.

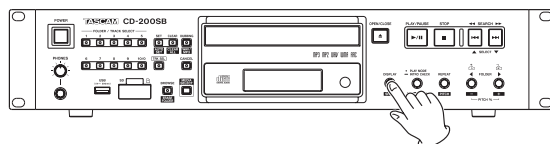

■ Audio CDs with CD text

When playing back or paused, you can change the information shown on the display, cycling through track elapsed time, track remaining time, total remaining time, track title and track artist.

When stopped, you can also change the information shown, but the album title, album artist and total number of tracks and total playback time are shown.

■ Audio CDs without CD text

When playing back or paused, you can change the information shown on the display, cycling through track elapsed time, track remaining time and total remaining time.

When stopped, you can also change the information shown, but the total number of tracks and total playback time are shown.

■ Data CD

When playing back or paused, you can change the information shown on the display, cycling through track elapsed time, track title, track artist and file name.

When stopped, you can still change the display mode from the track elapsed time to the album title.

When stopped, you can switch to the album title (current folder).

■ SD card/USB flash drive

When playing back, paused or stopped, you can change the information shown on the display, cycling through track elapsed time, track remaining time, title, artist and file name.

4 – Playback

NOTE

- After pressing the **DISPLAY [SHIFT]** button on the main unit or the **DISPLAY** button on the remote control, the currently selected type of information to be shown on the main display appears for two seconds as follows.

Track elapsed time: ELAPSED
Track remaining time: REMAIN
Total remaining time: T REMAIN
Album/track title: TITLE
Album/track artist: ARTIST
File name: FILENAME

- The text information that can be shown on the display is CD text information for audio CDs, ID3 tag information for data CDs and ID3, WMA and AAC tag information for SD cards and USB flash drives.

When information is not included for a disc or file, NO TITLE (title information) or NO NAME (artist information) is shown. If the information contains characters that cannot be displayed, those characters are replaced by _.

- When an audio CD is in programmed playback mode the elapsed time and remaining time of the entire program is shown.
- The display contents setting is retained even when the power is turned off.
- The number of songs and track numbers within a folder might not match on SD cards and USB flash drives that have been written on by a Mac. This is an existing problem with Mac system files, but it will not affect playback on this unit.

Pitch control (with CDs only)

Using pitch control playback, CDs can be played back at a different pitch (sound frequency and playback speed).

Follow the procedures below to use pitch control playback.

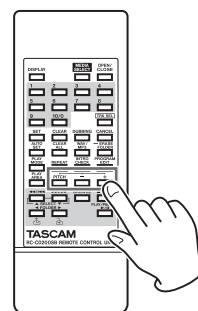
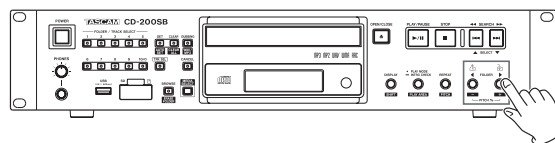

- Press the **REPEAT [PITCH]** button while pressing and holding the **DISPLAY [SHIFT]** button on the main unit or press the **PITCH** button on the remote control to turn pitch control ON. The current pitch control value is shown at this time.



- Use the **FOLDER </> [PITCH -/+]** buttons on the main unit or the **PITCH -/+** button on the remote control to set the pitch in 0.5% units in a range of $\pm 14.0\%$.
- To turn pitch control playback OFF: Press the **REPEAT [PITCH]** button while pressing and holding the **DISPLAY [SHIFT]** button on the main unit or press the **PITCH** button on the remote control.



NOTE

- During playback, turning pitch control playback ON or OFF might cause the playback sound to skip momentarily.
- Using pitch control playback with a data CD (MP3, WAV) sometimes causes the playback sound to skip.
- Digital output is possible when the pitch control function is ON during playback of MP3 and WAV files on audio CDs, but the sampling frequency is changed by an amount proportional to the pitch control value. When pitch control is ON, therefore, some equipment might not be able to receive the digital output signal from the CD-200SB.
- The pitch control function cannot be used with SD cards and USB flash drives.

Intro Check function

When stopped or during playback press and hold the main unit **PLAY MODE/INTRO CHECK [PLAY AREA]** button or press the remote **INTRO CHECK** button to play the first 10 seconds of each track one after another. The **INTRO** indicator appears when this function is active.

During intro check playback, press and hold the **PLAY MODE/INTRO CHECK [PLAY AREA]** button on the main unit or the **INTRO CHECK** button on the remote to return to ordinary playback mode (**INTRO** disappears from the display).

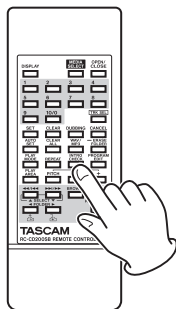
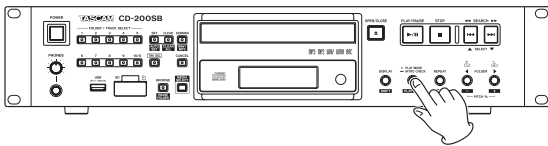

- When using Intro Check, briefly press the main unit **SEARCH** ◀◀/▶▶ [◀◀/▶▶], **SELECT** ▲/▼ buttons or the remote search (◀◀/▶▶ [SELECT ▲] and ▶▶/▶▶ [SELECT ▼]) buttons to skip to the preceding or next track.
- Press the **STOP** button to stop Intro Check.
- The intro check function can be used during program and folder playback modes.

5 – Browsing

Using this unit's browse function, you can examine the folder and file structure of SD cards and USB flash drives without need for a computer.

The name of the selected folder or file is shown on the display along with an icon that indicates its type.

You can search all the folders on the media, but this unit can only play back audio files with the following formats.

Audio file formats that this unit can play back

MP3, MP2, WAV, WMA, AAC

(WMA and AAC files can only be played back from SD cards and USB flash drives.)

The following information appears on the display when using this browse function.

Text characters

Shows the name of the selected folder or file.

Folder (📁)

When a folder is selected, this icon appears above the text that shows the folder name.



Audio file (🎵)

When an audio file is selected, this icon appears above the text that shows the audio file name.



NOTE

The folder icon (📁) and audio file icon (🎵) never appear at the same time.

Requirements for browsing

You can only browse the SD card or USB flash drive that has been inserted and selected as the current media.

Information shown when browsing

- Audio files (determined by extension)
Files other than audio files will not be shown.
- Folders

Browsing folders and files

Follow these procedures to move between and select folders and browse files.

1. Press the main unit **BROWSE [ERASE FOLDER]** button or the remote **BROWSE** button to enter browse mode. When browse mode is active, the main unit **BROWSE [ERASE FOLDER]** and **CANCEL** indicators light.

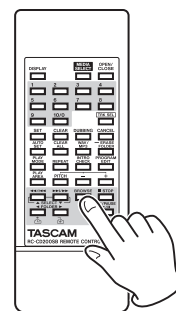
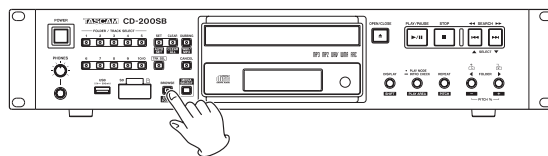

2. The name of the first folder or file at the top (root) level is shown in the main display area. To view other folders and files on the same level, use the main unit **SEARCH** (◀/▶) [◀/▶], **SELECT** (▲/▼) buttons or the remote search (◀/▶) [SELECT ▲] and ▶/▶ [SELECT ▼] button to change the selection. Press the **CANCEL** button on the main unit or the remote to exit BROWSE mode.

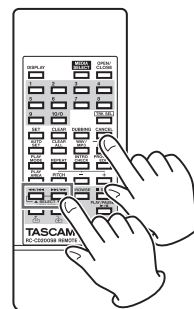
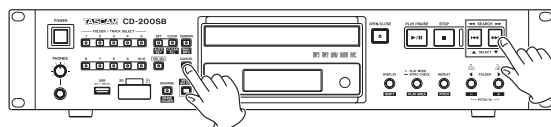

- To move down a level, select the folder (📁) you want to open, and press the main unit **FOLDER ▶ [PITCH +, 📁]** button or the remote **FOLDER ▶ [📁]** button. After opening a folder, the first subfolder or track inside that folder is shown on the display.

To move up a level (close the open folder), press the main unit **FOLDER ◀ [PITCH –, 📁]** button or the remote **FOLDER ◀ [📁]** button.

After moving up a level, the folder that had been open will be the selected folder shown on the display.

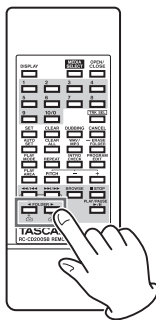
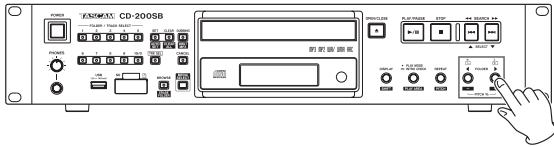

NOTE

- When a file is selected (📄), the main unit **FOLDER ▶ [PITCH +, 📁]** button and remote **FOLDER ▶ [📁]** button have no effect.
- When a folder or file in the top level (root) is shown, the main unit **FOLDER ◀ [PITCH –, 📁]** button and remote **FOLDER ◀ [📁]** button have no effect.

- When a file is selected (📄), press the **PLAY/PAUSE** button on the main unit or the remote control to start playback of that file.

TIP

- If you enter browse mode during playback, the file being played back will be selected.
- Depending on the playback area setting, the playback area might change after selecting a file using the browse function. When the playback area is set to **ALL PLAY**, all files on the current media starting with the selected file will play back. When the playback area is set to **FOLDER**, the folder that contains the selected file will become the playback area.

NOTE

- In browse mode, all folders are shown, even folders that do not contain audio files or that are completely empty.
- Only files in formats that this unit can play are shown
- If you open a folder that does not contain any playable files, **NO FILES** will appear on the display.
- When the playback mode is set to random or program, playback is not possible in browse mode.

6 – Direct folder function

You can assign folders on an SD card or USB flash drive to the main unit **FOLDER/TRACK SELECT (1–10/0)** buttons. When you press a button with an assigned folder, you can immediately select that folder on the SD card or USB flash drive and start playback.

A folder that has been assigned to a main unit **FOLDER/TRACK SELECT (1–10/0)** button using this function is called a “direct folder”.

A maximum of 10 direct folders can be assigned.

NOTE

- The direct folder function can only be used with SD cards and USB flash drives. It cannot be used with audio or data CDs.
- The main unit **FOLDER/TRACK SELECT (1–10/0)** buttons and the remote number (1–10/0) buttons can be used in the same way.
- You can assign direct folders to the main unit **FOLDER/TRACK SELECT (1–10/0)** buttons for each SD card and USB flash drive.
- You cannot mix the direct folder assignments of the main unit **FOLDER/TRACK SELECT (1–10/0)** buttons between an SD card and a USB flash drive.

Saving direct folder settings

With this unit, direct folder assignments that have been made for the main unit **FOLDER/TRACK SELECT (1–10/0)** buttons (direct folder settings) are automatically saved to each SD card and USB flash drive.

This data is saved in a CD-200SB settings file named, “cd-200sb.dat” that is created in the root of each SD card and USB flash drive used with this unit.

Do not alter this settings file, because doing so could result in not being able to use the direct folder function correctly and other problems.

- This file is automatically saved when playback of the media is stopped.
- If settings are changed when playing back or paused, they will be saved automatically when playback is stopped.

During automatic saving, **WRITING** appears on the display. In addition, settings saved on media will be automatically read the next time the media is loaded (for example, when the power is turned ON), enabling use of direct folder settings for the **FOLDER/TRACK SELECT (1–10/0)** buttons quickly.



NOTE

- If an SD card or USB flash drive is loaded in another CD-200SB unit, the direct folder settings saved on it will automatically be read from that media, enabling use of direct folder settings for the **FOLDER/TRACK SELECT (1–10/0)** buttons quickly.
- If a direct folder assignment has been changed during playback or when paused, be sure to stop playback once so that the setting can be saved to the media.
- If an SD card or USB flash drive is write-protected, the direct folder settings cannot be saved to that media. In this case, **PROTECT** will appear on the display for a few seconds before disappearing.



- If the media does not have enough open space, direct folder settings cannot be written to it. In this case, **FULL** will appear on the display for a few seconds before disappearing.



- If direct folder settings cannot be written to the media for the above reasons, they will be lost when this unit's power is turned OFF.

Assigning direct folders

Using this function, folders on SD cards and USB flash drives can be assigned to the main unit **FOLDER/TRACK SELECT (1–10/0)** buttons as direct folders.

Assignments can either be made individually or automatically all at once. In either case the maximum number of assignments is 10.

Assigning direct folders individually

1. Press the **MEDIA SELECT** button on the main unit or the remote and select the media that contains the folder that you want to assign as a direct folder. (See “Selecting the playback media” on page 19.)
2. Press the main unit **SET [AUTO SET]** button or the remote **SET** button to enable direct folder setting mode.

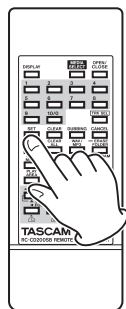
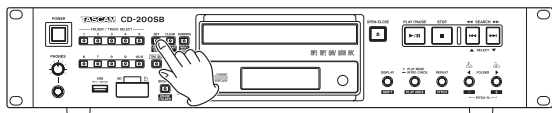

When this mode is enabled, the main unit **SET [AUTO SET]** indicator lights, and **SET** and the name of the current folder appear on the display alternately.



The indicators for the **FOLDER/TRACK SELECT (1–10/0)** buttons that do not yet have direct folder assignments and the **CANCEL** indicator blink. The indicators for the **FOLDER/TRACK SELECT (1–10/0)** buttons that already have direct folder assignments light.

When the main unit **CANCEL** indicator is blinking, you can press the **CANCEL** button on the main unit or the remote to cancel assignment and return to ordinary playback mode.

NOTE

You can overwrite an existing direct folder assignment to change it. (See “Changing individual direct folder assignments” on page 34.)

3. Use the **FOLDER** ◀/▶ buttons on the main unit or the remote control to select (show) the folder you want to assign as a direct folder. The current folder name shown on this display changes each time you change the selection.
4. Choose a **FOLDER/TRACK SELECT (1–10/0)** button that does not yet have a direct folder assignment (Indicator blinking) and press the button to assign the folder. After registration completes, **DONE** will appear on the display for a few seconds and then the unit will return to ordinary playback mode.



Automatically assign all direct folders (AUTO SET)

1. Press the **MEDIA SELECT** button on the main unit or the remote and select the media that contains the folders that you want to assign as direct folders. (See “Selecting the playback media” on page 19.)
2. When stopped, press the **SET [AUTO SET]** button while pressing and holding the main unit **DISPLAY [SHIFT]** button or press the remote **AUTO SET** button to enter direct folder AUTO SET mode.

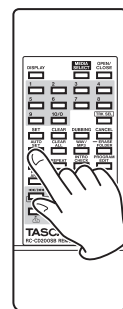
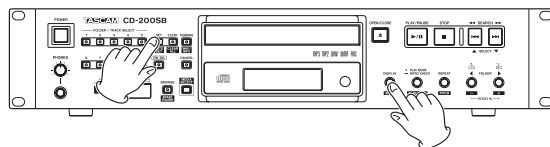

When this mode is enabled, the main unit **SET [AUTO SET]** indicator blinks, and **AUTO SET** appears on the display.



6 – Direct folder function

- Press the main unit **SET [AUTO SET]** button or the remote **AUTO SET** button again.
The unit automatically checks which of the 1–10/0 buttons do not yet have direct folder assignments and assigns folders to them.
SETTING appears on the display while this is happening.



After registration completes, **DONE** will appear on the display for a few seconds and then the unit will return to ordinary playback mode.



When the main unit **CANCEL** indicator is blinking, you can press the **CANCEL** button on the main unit or the remote to cancel assignment and return to ordinary playback mode.

NOTE

- FOLDER/TRACK SELECT (1–10/0)** buttons that already have assignments will not be overwritten.
- Unlike during individual folder assignment, the indicators for **FOLDER/TRACK SELECT (1–10/0)** button that do not yet have direct folder assignments do not blink.
- Assignments are made in the same order as folder searching as described in see "Folders and tracks on data CDs, SD cards and USB flash drives" on page 20. However, since already assigned folders are excluded, the same folder will not be assigned to more than one **FOLDER/TRACK SELECT (1–10/0)** button.
- Assignments are made to **FOLDER/TRACK SELECT (1–10/0)** buttons in order starting with the lowest number.

Changing individual direct folder assignments

When assigning direct folders, indicators light on the main unit **FOLDER/TRACK SELECT (1–10/0)** buttons that already have direct folder assignments.

To change direct folder assignments, you must overwrite them.

- Press the **MEDIA SELECT** button on the main unit or the remote and select the media that contains the folder that you want to assign as a direct folder. (See "Selecting the playback media" on page 19.)
- Press the main unit **SET [AUTO SET]** button or the remote **SET** button to enable direct folder setting mode.
- Use the main unit or remote **FOLDER** ◀/▶ buttons to select the folder that you want to assign.
- Press a **FOLDER/TRACK SELECT (1–10/0)** button that already has a direct folder assignment (indicator lit). The indicator for that button will start to blink. At the same time the indicators for all other buttons will become unlit.
UPDATE appears on the display, showing that the unit is ready to change the assignment.



- Press the **FOLDER/TRACK SELECT (1–10/0)** button, which now has a blinking indicator, again to change the direct folder assignment.
When the main unit **CANCEL** indicator is blinking, you can press the **CANCEL** button on the main unit or the remote to cancel assignment and return to step 2 above (direct folder setting mode).

NOTE

- Changing direct folder assignments never erases folders on media or audio files within folders.
- You can use the **FOLDER** ◀/▶ buttons on the main unit or the remote control to select folders and assign them to different **FOLDER/TRACK SELECT (1–10/0)** buttons.

Direct folder playback

When the main unit **TRK SEL** indicator is not lit, lit indicators for the **FOLDER/TRACK SELECT (1–10/0)** buttons show they have direct folder assignments for the current media (SD card or USB flash drive).

Press a **FOLDER/TRACK SELECT (1–10/0)** button that has a lit indicator to start playback of the folder assigned to that button.

During direct folder playback, the indicator for the **FOLDER/TRACK SELECT (1–10/0)** button of the assigned folder that is playing back blinks slowly.

Example of direct folder assignments

Button 1 01_FILE_1-1.wav 02_FILE_1-2.wav 03_FILE_1-3.wav 04_FILE_1-4.wav 05_FILE_1-5.wav 06_FILE_1-6.wav 07_FILE_1-7.wav 08_FILE_1-8.wav 09_FILE_1-9.wav 10_FILE_1-10.wav 11_FILE_1-11.wav 12_FILE_1-12.wav	Button 2 01_FILE_2-1.mp3 02_FILE_2-2.mp3 03_FILE_2-3.mp3 04_FILE_2-4.mp3 05_FILE_2-5.mp3 06_FILE_2-6.mp3 07_FILE_2-7.mp3 08_FILE_2-8.mp3 09_FILE_2-9.mp3 10_FILE_2-10.mp3 11_FILE_2-11.mp3 12_FILE_2-12.mp3	Button 3 01_FILE_3-1.wma 02_FILE_3-2.wma 03_FILE_3-3.wma 04_FILE_3-4.wma 05_FILE_3-5.wma 06_FILE_3-6.wma 07_FILE_3-7.wma 08_FILE_3-8.wma : : : 19_FILE_3-19.wma 20_FILE_3-20.wma	Button 4 No direct folder assigned	Button 5 01_FILE_5-1.wav 02_FILE_5-2.wav 03_FILE_5-3.wav 04_FILE_5-4.wav 05_FILE_5-5.wav 06_FILE_5-6.wav 07_FILE_5-7.wav 08_FILE_5-8.wav 09_FILE_5-9.wav 10_FILE_5-10.wav
Button 6 No direct folder assigned	Button 7 01_FILE_7-1.3gp 02_FILE_7-2.3gp 03_FILE_7-3.3gp 04_FILE_7-4.3gp 05_FILE_7-5.3gp 06_FILE_7-6.3gp 07_FILE_7-7.3gp 08_FILE_7-8.3gp : : : 23_FILE_7-23.3gp 24_FILE_7-24.3gp	Button 8 No direct folder assigned	Button 9 No direct folder assigned	Button 10/0 01_FILE_10-1.mp3 02_FILE_10-2.mp3 03_FILE_10-3.mp3 04_FILE_10-4.mp3 05_FILE_10-5.mp3 06_FILE_10-6.mp3 07_FILE_10-7.mp3 08_FILE_10-8.mp3 09_FILE_10-9.mp3 10_FILE_10-10.mp3 11_FILE_10-11.mp3 12_FILE_10-12.mp3

Setting the playback area with direct folders

Direct folders are played back according to the playback area setting as follows. Press the main unit **PLAY MODE/INTRO CHECK [PLAY AREA]** button while pressing and holding the **DISPLAY [SHIFT]** button, or press the remote **PLAY AREA** button to set the playback area. (See “Setting the playback area” on page 21.)

ALL PLAY

The playback area includes all folders assigned to **FOLDER/TRACK SELECT (1–10/0)** buttons (indicators lit).

For example, after playback of the last track in the folder assigned to button 1 (12_FILE_1-12.wav in the illustration above) ends, playback continues with the first track in the folder assigned to button 2 (01_FILE_2-1.mp3).



FOLDER (FOLDER appears on display)

The playback area is the folder assigned to the **FOLDER/TRACK SELECT (1–10/0)** button (indicator lit) pushed to start playback.



Selecting the playback mode with direct folders

Direct folders play back according to the playback mode as follows. Press the main unit **PLAY MODE/INTRO CHECK [PLAY AREA]** button or the remote **PLAY MODE** button to select the playback mode. (See “Selecting the playback mode” on page 22.)

Continuous playback mode

- The selected direct folder plays back from its first track to its last track.
For example, if you press button **1**, the tracks in the assigned folder will be played back from first to last.
- If the playback area is set to **ALL PLAY**, after the last track in a folder plays back, playback of the next direct folder will begin.
For example, after playback of the last track in the folder assigned to button **1** (12_FILE_1-12.wav in the illustration above) ends, playback continues with the first track in the folder assigned to button **2** (01_FILE_2-1.mp3).
- If the playback area is set to **FOLDER** and the repeat playback function is **OFF**, playback stops after the last track plays back.
For example, after playback of the last track in the folder assigned to button **1** (12_FILE_1-12.wav in the illustration above) ends, playback stops.
- If the playback area is set to **ALL PLAY** and the repeat playback function is **ON**, after the last track in the folder assigned to the highest-numbered button plays back, playback will continue from the direct folder assigned to the lowest-numbered button.
For example, after playback of the last track in the folder assigned to button **10/0** (12_FILE_10-12.mp3 in the illustration above) ends, playback continues from the first track (01_FILE_1-1.wav) in the folder assigned to button **1**.

Single playback mode

- The first track in the selected direct folder plays back, and then playback stops.
- If you skip tracks during playback, it is possible to move to the second and later tracks in the folder. The tracks that can be skipped to, however, depend on the playback area setting.
For example, when you skip from the last track in the folder assigned to button **1** (12_FILE_1-12.wav in the illustration above), if the playback area is set to **ALL PLAY**, the first track in the folder assigned to button **2** (01_FILE_2-1.mp3) will be selected. If the playback area is set to **FOLDER**, the first track in the folder assigned to button **1** (01_FILE_1-1.wav) will be selected.
- If the repeat playback function is **ON**, the track that is playing will be played back repeatedly.

6 – Direct folder function

Random playback mode

- The tracks in the selected direct folder play back in random order.
For example, if you press button 1, all the tracks in the assigned folder will be played back in random order.
- If the playback area is set to **ALL PLAY**, after all the tracks in the folder have played back, playback of the next direct folder will begin with all the tracks in it played back in random order.
For example, after random playback of all the tracks in the folder assigned to button 1 ends, random playback of all the tracks in the folder assigned to button 2 will begin.
- If the playback area is set to **FOLDER** and the repeat playback function is **OFF**, playback stops after all the tracks in the folder have been played back.
For example, after random playback of all the tracks in the folder assigned to button 1 ends, playback stops.
- If the playback area is set to **ALL PLAY** and the repeat playback function is **ON**, after all the tracks in the folder assigned to the highest-numbered button have been played back, random playback of the direct folder assigned to the lowest-numbered button begins.
For example, after random playback of all the tracks in the folder assigned to button 10/0 ends, random playback of all the tracks in the folder assigned to button 1 begins.

Program playback mode

- If program playback mode (**PROG** indicator appears) is in use, pressing a direct folder button will make the playback mode change automatically to continuous playback mode and begin direct folder playback.
If a program had been set, it will be cleared.

Using folder search/browse functions during direct folder playback

Using the folder search or browse function during direct folder playback will stop direct folder playback.

ALL PLAY

- After changing the selected folder by searching during direct folder playback, the entire media will begin playing back from the first track.
- After using the browse function during direct folder playback, the file selected using the browse function will begin playing back, and playback of later tracks will continue in order until the end of the media.

FOLDER (FOLDER appears on display)

- After changing the selected folder by searching during direct folder playback, the folder selected using folder search will begin playing back from its first track.
- After using the browse function during direct folder playback, the file selected using the browse function will begin playing back, and playback of later tracks will continue in order until the last track in the folder ends.

Clearing direct folder assignments

You can clear the direct folder assignments of the main unit **FOLDER/TRACK SELECT (1–10/0)** buttons.

Assignments can be cleared either individually or automatically all at once.

NOTE

Clearing direct folder assignments never erases folders on media or audio files within folders.

*After clearing direct folder assignments, you can use the **FOLDER** ◀/▶ buttons on the main unit or the remote control to select folders and assign them to different **FOLDER/TRACK SELECT (1–10/0)** buttons.*

Clearing individual direct folder assignments

1. Press the **MEDIA SELECT** button on the main unit or the remote and select the media that contains folders with direct folder assignments.

The **SD** icon will appear on the display if an SD card is selected and the **USB** icon will appear if a USB flash drive is selected.

NOTE

You cannot select media that is not loaded.

2. Press the main unit **CLEAR [CLEAR ALL]** button or the remote **CLEAR** button.

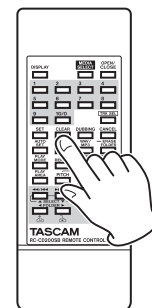
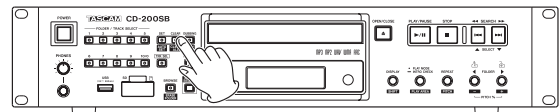

The main unit **CLEAR [CLEAR ALL]** button indicator lights and **CLEAR** appears on the display.



The indicators for the **FOLDER/TRACK SELECT (1–10/0)** buttons with direct folder assignments and the **CANCEL** button blink.

To cancel the operation, when the main unit **CANCEL** indicator is blinking, press the **CANCEL** button on the main unit or the remote. After canceling the operation, the display returns to its previous state.

6 – Direct folder function

- Press the 1–10/0 button with a blinking indicator that has the direct folder assignment that you want to clear. After the assignment has been cleared, **DONE** appears on the display for a few seconds and then, it returns to its previous state.



Clearing all direct folder assignments (CLEAR ALL)

You can clear the direct folder assignments for all the main unit **FOLDER/TRACK SELECT (1–10/0)** buttons at once.

- Press the **MEDIA SELECT** button on the main unit or the remote and select the media that contains folders with direct folder assignments. The **SD** icon will appear on the display if an SD card is selected and the **USB** icon will appear if a USB flash drive is selected.

NOTE

You cannot select media that is not loaded.

- Press the main unit **CLEAR [CLEAR ALL]** button while pressing and holding the **SHIFT** button, or press the remote **CLEAR ALL** button.

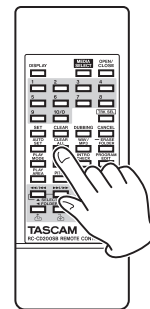
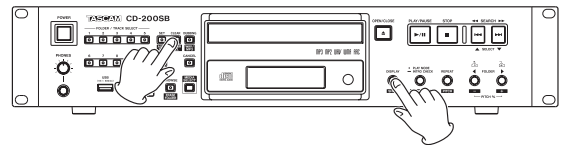

The main unit **CLEAR [CLEAR ALL]** button indicator blinks and **CLEARALL** appears on the display.



- Press the main unit **CLEAR [CLEAR ALL]** button or the remote **CLEAR ALL** button again to clear all direct folder assignments for the **FOLDER/TRACK SELECT (1–10/0)** buttons.
- When clearing completes, **DONE** appears on the display for a few seconds and then it returns to its previous state.



To cancel the operation, when the main unit **CANCEL** indicator is blinking, press the **CANCEL** button on the main unit or the remote. After canceling the operation, the display returns to its previous state.

7 – Dubbing (copying)

Using this unit's dubbing (copying) function you can dub the content of a CD to an SD card or USB flash drive. Moreover, you can change the format used for the dubbed files.

Dubbing overview

When this unit dubs a CD to an SD card or USB flash drive, it plays the CD back continuously regardless of the playback mode setting.

When dubbing a data CD, depending on the playback area setting, the entire CD (ALL PLAY) or the current folder (FOLDER) will be dubbed to the SD card or USB flash drive.

Dubbing always creates new folders and creates the dubbed files in those folders.

Dubbing never deletes existing files.

A dubbed folder can be assigned as a direct folder to the selected main unit **FOLDER/TRACK SELECT (1-10/0)** button or remote number **(1-10/0)** button.

Formats of dubbed files

This unit can create dubbed files in the following formats.

WAV

MP3 (HQ/MQ/LQ)

NOTE

When dubbing, a folder named "/music/albumXXX/" ("XXX" is a 3-digit number, such as "001") is created on the media used for dubbing, and a file is created for each dubbed CD track with a file name in the format "trackXXX.wav" (or "trackXXX.mp3"). When set to ALL PLAY, if you dub a data CD with multiple folders, all the files will be dubbed to single folder.

Operation during dubbing

During dubbing, this unit operates in the following manner.

- The audio of the CD being dubbed is output.
- SD cards and USB flash drives cannot be played back.
- Continuous playback mode is used for CD playback regardless of the playback mode setting.

NOTE

- *Depending on the SD card or USB flash drive used for dubbing, recording might not be able to keep up with the audio input. If this occurs, the CD playback sound might skip or parts of the audio might be repeated during playback. This will not, however, affect the recording to the SD card or USB flash drive.*
- *When an audio CD is dubbed, silent gaps will occur between dubbed tracks when they are played back even if the audio on the CD was continuous between tracks.*
- *When dubbing a data CD, it does not simply copy the files on the CD to the SD card or USB flash drive.*
- *Regardless of the sampling rates of the source files, the dubbed files will all be converted to a sampling rate of 44.1 kHz.*

Dubbing is not possible in the following cases.

Dubbing source cannot be an SD card or USB flash drive

This unit can only dub from audio and data CDs. It cannot dub the content of an SD card or USB flash drive.

Dubbing destination media is write-protected

PROTECT will appear on the display for a few seconds and the unit will return to its previous state.



Dubbing destination does not have enough open space

FULL will appear on the display for a few seconds and the unit will return to its previous state. Furthermore, if the dubbing destination runs out of space during dubbing, FULL will appear on the screen for a few seconds and dubbing will stop.



Dubbing

1. Load the dubbing source CD.
If the dubbing source CD is a data CD, press the main unit or remote **MEDIA SELECT** button to set the dubbing source media to CD. (See “Selecting the playback media” on page 19.)
Set the playback area to ALL PLAY or FOLDER as necessary. If set to FOLDER, use the main unit or remote **FOLDER** ◀/▶ buttons to select the folder that you want to dub. (See “5 – Browsing” on page 30.)

NOTE

When dubbing an audio CD, setting the playback area is not necessary.

2. Press the **MEDIA SELECT** button on the main unit or the remote to select the dubbing destination media (SD card or USB flash drive).
-SD- or -USB- will appear on the display.

NOTE

- If only one type of media—an SD card or a USB flash drive—is loaded, that media will be the dubbing destination regardless of the current media setting made using the **MEDIA SELECT** button on the main unit or the remote.
 - If both an SD card and a USB flash drive are loaded and the media selected using the **MEDIA SELECT** button on the main unit or the remote is either SD card or CD, the CD will be dubbed to the SD card. If the media selected is the USB flash drive, the CD will be dubbed to the USB flash drive.
3. Press the main unit **DUBBING [WAV/MP3]** button while pressing and holding the **DISPLAY [SHIFT]** button or press the remote **WAV/MP3** button to set the file format used when writing to the dubbing destination.

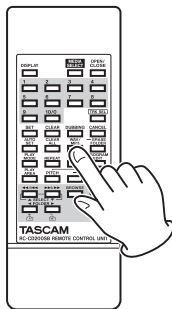
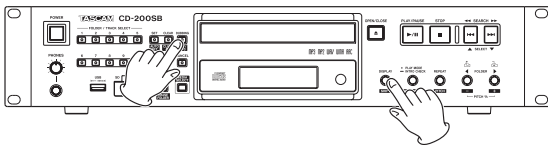

→ DUB WAV → DUBMP3HQ → DUBMP3MQ → DUBMP3LQ

Cycle through dubbing destination file formats

Dubbing file format settings

Display	File format
DUB WAV	44.1kHz 16-bit stereo WAV
DUBMP3HQ (default value)	44.1kHz 256kbps stereo MP3
DUBMP3MQ	44.1kHz 128kbps stereo MP3
DUBMP3LQ	44.1kHz 64kbps stereo MP3

When the current format setting is shown, press the main unit **DUBBING [WAV/MP3]** button while pressing and holding the **DISPLAY [SHIFT]** button or the remote **WAV/MP3** button again to cycle through the setting options.

NOTE

The dubbing destination file format setting is retained even when the power is turned OFF.

4. Press the main unit **DUBBING [WAV/MP3]** button or the remote **DUBBING** button.

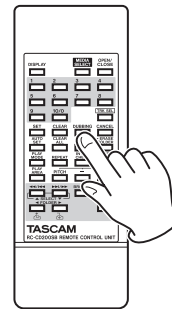
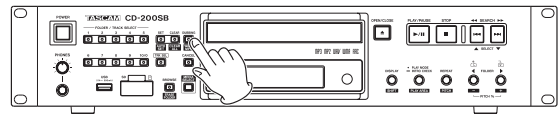

WAIT appears on the display as the unit begins checking the dubbing destination media.



5. After the dubbing destination media has been successfully confirmed, SEL FLDR appears on the display and the **FOLDER/TRACK SELECT (1-10/0)** button indicators blink or light.



Blinking indicators show that no direct folder has been assigned to that button. Lit indicators show that a folder has been assigned.

7 – Dubbing (copying)

- Press the main unit **FOLDER/TRACK SELECT (1–10/0)** button or the remote number **(1–10/0)** button for the folder that you want to select as the dubbing destination. **PREPARE** appears on the display for a few seconds, then the time counter for the track being dubbed is shown and dubbing begins.



NOTE

- When selecting the dubbing destination folder, you can choose folders that have blinking or lit indicators.
 - If you press a **FOLDER/TRACK SELECT (1–10/0)** button that does not have a direct folder assigned (blinking indicator), a new folder will be created for dubbing and that folder will automatically be assigned to that button.
 - If you press a **FOLDER/TRACK SELECT (1–10/0)** button that does have a direct folder assigned (lit indicator), dubbing will overwrite the current folder assignment. (See "Dubbing using a 1–10/0 button that already has a direct folder assignment" on page 40.)
- While dubbing, you can press the **CANCEL** button (lit on main unit) or **STOP** button on the main unit or the remote to stop the operation. After canceling the operation, **CANCELED** will appear on the display for a few seconds.



NOTE

- If you cancel dubbing in the middle of the first track, no files will be created on the SD card or USB flash drive. Furthermore, the folder created at the beginning of dubbing will be erased.
 - If you cancel dubbing any time after the first track has been dubbed, files that have completed dubbing will be created on the SD card or USB flash drive. Furthermore, the folder created at the beginning of dubbing will be assigned to the **FOLDER/TRACK SELECT (1–10/0)** button selected in step 6 above.
- When the last track on the CD (or in the selected folder of the data CD) finishes dubbing, **FINISHED** appears on the display, and then the unit returns to the state it was in before dubbing began. The folder created at the beginning of dubbing will be assigned to the **FOLDER/TRACK SELECT (1–10/0)** button selected in step 6 above, and that **FOLDER/TRACK SELECT (1–10/0)** button will light.



NOTE

The date and time data of folders and audio files created by dubbing will be different from the current date and time.

Dubbing using a 1–10/0 button that already has a direct folder assignment

When dubbing, you can use the following procedure to overwrite an existing direct folder assignment.

- After pressing the main unit **DUBBING [WAV/MP3]** button or the remote **DUBBING** button (the main unit **DUBBING [WAV/MP3]** indicator lit), press a lit **FOLDER/TRACK SELECT (1–10/0)** button that already has a direct folder assignment (indicator lit). The indicator for that button will start to blink. At the same time the indicators for all other buttons will become unlit. **UPDATE** appears on the display, showing that the unit is ready to change the assignment.



- Press the **FOLDER/TRACK SELECT (1–10/0)** button, which now has a blinking indicator, again to start dubbing. When dubbing completes, the direct folder assignment for the selected **FOLDER/TRACK SELECT (1–10/0)** button will be changed. Before starting dubbing when **UPDATE** is shown on the display and the main unit **CANCEL** indicator is blinking, you can press the **CANCEL** button on the main unit or the remote to cancel changing the assignment and return to step 5 of "Dubbing" above.

NOTE

Changing direct folder assignments for **FOLDER/TRACK SELECT (1–10/0)** buttons never erases folders on media or audio files within folders.

You can use the **FOLDER ◀/▶** buttons on the main unit or the remote control to select folders and assign them to different **FOLDER/TRACK SELECT (1–10/0)** buttons.

Recording times when dubbing

The following table shows recording times (in hours and minutes) for different file formats and SD/SDHC card and USB flash drive capacities.

File format (dubbing setting)			SD card/USB flash drive			
			1 GB	2 GB	4 GB	8 GB
WAV (STEREO)	16 bit	44.1 kHz	1:34	3:08	6:17	12:35
	64 kbps (LQ)	44.1 kHz	34:42	69:25	138:35	277:29
MP3 (STEREO)	128 kbps (MQ)	44.1 kHz	17:21	34:42	69:17	138:44
	256 kbps (HQ)	44.1 kHz	8:40	17:21	34:38	69:22

- The above recording times are approximate. They may differ according to the SD/SDHC card or USB flash drive being used.
- The above recording times are not continuous recording times. They are total possible recording times for SD/SDHC cards and USB flash drives.

8 – Erase folder function

Using this unit, you can erase unwanted folders containing audio files on SD cards and USB flash drives.

CAUTION

- You cannot use this unit to erase individual files.
- All files (not just music files) in the designated folder will be erased, regardless of their statuses (Read Only, etc.).

Erasing folders

1. Use the **MEDIA SELECT** button to select the media (SD card or USB flash drive) that contains the folder you want to erase.
2. Press the main unit **BROWSE [ERASE FOLDER]** button while pressing and holding the **DISPLAY [SHIFT]** button or press the remote **ERASE FOLDER** button to enter erase folder mode.

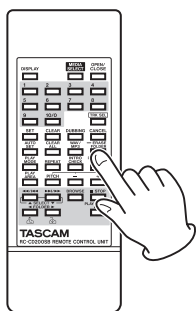
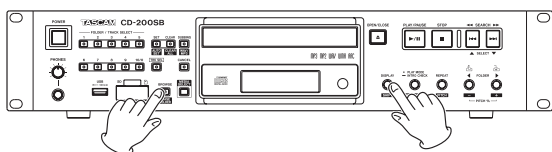

When erase folder mode is enabled, the main unit **BROWSE [ERASE FOLDER]** and **CANCEL** indicators blink, and **ERASE** and the name of the current folder appear alternately on the display.



3. If you want to erase the currently selected folder, skip to the next step.
If you want to erase a folder of audio files other than the currently selected folder, select the folder that you want to erase using the main unit **FOLDER/TRACK SELECT (1-10/0)** buttons, the remote number **(1-10/0)** buttons and the **FOLDER** **◀/▶** buttons on the main unit or the remote control.

NOTE

When the main unit **CANCEL** indicator is blinking, you can press the **CANCEL** button on the main unit or the remote to cancel erasing the folder. The display returns to its state before entering erase folder mode.

4. When the folder is selected, press the main unit **BROWSE [ERASE FOLDER]** button or the remote **ERASE FOLDER** button again to erase the folder.
ERASING appears on the display for a few seconds while the folder is being erased.



If the selected folder does not have a subfolder, all the files in it (not just music files) will be erased. If this results in the folder that contained the erased folder also becoming empty, that folder will also be erased.

If the selected folder has a subfolder, all the files (not just music files) in the folder except the files in the subfolder will be erased.

NOTE

- If the selected media (SD card/USB flash drive) is write-protected, the erase folder function will not function. In this case, **PROTECT** will appear on the display for a few seconds and the unit will return to its previous state.



- If a folder that is assigned to a main unit **FOLDER/TRACK SELECT (1-10/0)** button is erased, that assignment will automatically be cleared.

9 – Message Lists

Operation messages

Depending on the operation of the unit, the following messages will appear in the main display area.

Message	Meaning	Response
CANCELED	An operation has been canceled.	
-CLEAR-	All programs have been cleared.	
CLOSE	The disc tray is closing.	
DONE	An operation has completed.	
ERASING	A folder is being erased. Do not remove the media.	
FINISHED	An operation has completed.	
LOADING	Media information is being read.	
NO DISC	There is no disc or the disc cannot be verified.	
NO FILES	The disc has no files that can be played back.	Load a disc or other media that contains playable files.
NO MEDIA	There is no media.	
NO NAME	There is no artist data or no file data that can be displayed.	
NO TITLE	There is no title data that can be displayed.	
OPEN	The disc tray is open.	
SETTING	The AUTO SET operation is in progress. Do not remove the media.	
TOC READ	TOC information is being read.	
WAIT	A file is being processed. Do not remove the media.	
WRITING	Data is being written to the media. Do not remove the media.	

Warning messages

If an operation cannot be completed, one of the following messages will appear for about two seconds and then disappear.

Message	Meaning	Response
FULL	There is not enough space.	Delete unnecessary files or replace the media.*
NO MEDIA	No media is loaded.	Confirm that the media is properly loaded. If this does not work, try replacing the media.
NO PGM	No program has been created.	Add tracks to the program.
PGM FULL	No more tracks can be added to the program.	A program can contain a maximum of 99 tracks. Clear tracks from the program and try again.
PROTECT	The SD card/USB flash drive is write-protected.	Unlock the write-protection.
WRT ERR	A file could not be created.	Format the media using a computer. If this does not work, try replacing the media.

* After deleting a file on an SD card or USB flash drive using a Mac, empty the Trash before ejecting it.

9 – Message Lists

Error messages

If one of the following error messages is shown, please refer to the Response column and try to resolve it. If you are still unable to correct the problem, please contact the nearest retailer or TASCAM representative.

Message	Meaning	Response
COMM ERR (Blinking)	Cannot communicate with the CD drive.	Contact the nearest retailer or TASCAM representative.
COMM ERR	An error occurred during communication with the CD drive.	Contact the nearest retailer or TASCAM representative.
DEC ERR	The file type is not supported or otherwise could not be played.	Change the disc
DISC ERR	The TOC or file system could not be read, or focus adjustment was not possible.	Clean or change the disc.
DRV ERR	The CD drive hardware is broken.	Contact the nearest retailer or TASCAM representative.
MEDIAERR	The file system cannot be read.	Format the media using a computer. If this does not work, try replacing the media.
PATH ERR	The path might either be too long or contain characters that the unit cannot recognize.	Revise the folder and file names so that the path, including the file extension, contains only ASCII characters and is no more than 255 characters. (The maximum number of folder levels is 16.)
READ ERR	The track cannot be accessed.	Clean or change the disc.

10 – Troubleshooting

If you have problems with your system, look through this chart and see if you can solve the problem yourself before calling the nearest retailer or TASCAM representative.

■ No power

- ➔ Is the unit's power plug completely inserted into a working power outlet?

■ Remote control doesn't work.

- ➔ Check to see if the batteries are properly installed in the remote control.
- ➔ If the batteries are dead, change the batteries.

■ No sound

- ➔ Check the connection to the monitor system again.
- ➔ Check the volume and settings of the amplifier.

■ There is unwanted noise.

- ➔ Are the connecting cables all properly connected and functioning?

■ A CD cannot be played back.

- ➔ If you are using a data CD with MP3 files, confirm that the file bit-rates are compatible with this unit.
- ➔ Is the disc scratched or dirty?

■ I cannot play back all the files on a data CD, SD card or USB flash drive.

- ➔ Make sure the unit is not in folder playback mode.

■ I cannot use program playback.

- ➔ Make sure the playback area is not set to **ALL PLAY**. To use program playback with data CDs, SD cards and USB flash drives, the playback area must be set to **FOLDER**.

11 – Specifications

Ratings

Supported media types

CD, CD-R and CD-RW discs

(including 12cm, 8cm and multisession discs and discs with CD text)

The following types of media must be formatted in FAT16 or FAT32 format.

USB (4GB–64GB)

SD (2GB)

SDHC (4GB–32GB)

Playback file formats

CD-DA: 44.1kHz, 16-bit stereo

MP2: 32/44.1/48kHz, 32–320kbps
(data CDs/SD cards/USB flash drives)

MP3: 32/44.1/48kHz, 32–320kbps, VBR
(data CDs/SD cards/USB flash drives)

WAV: 8/16/32/11.025/22.05/44.1/12/24/48kHz, 16-bit
(data CDs/SD cards/USB flash drives)

AAC*: 32/44.1/48kHz, 32–320kbps, VBR
(SD cards/USB flash drives)

WMA**: 32/44.1/48kHz, 32–384kbps, VBR
(SD cards/USB flash drives)

*AAC DRM not supported

**WMA files must be compliant with Ver. 9 Standard; DRM is not supported.

Dubbing file formats

WAV: 44.1kHz, 16-bit stereo

MP3: 44.1kHz, 64/128/256kbps

Output ratings

Analog audio output ratings

ANALOG OUTPUT (BALANCED)

Connector: XLR-3-32 (1: GND 2: HOT 3: COLD)

Output impedance: 200 Ω

Reference Output Level: +4 dBu (1.23 Vrms)

Maximum Output Level: +20 dBu (7.75 Vrms)

ANALOG OUTPUT (UNBALANCED)

Connector: RCA pin jack

Output Impedance: 200 Ω

Reference Output Level: –10 dBV (0.32 Vrms)

Maximum Output Level: +6 dBV (2.0 Vrms)

PHONES output

Connector: 6.3 mm (1/4") Stereo Phone Jack

Maximum Output Level: 20 mW + 20 mW

(THD+N: 0.1%, 32 Ω)

Digital audio output ratings

DIGITAL OUTPUT (COAXIAL)

Connector: RCA Pin Jack

Compatible Signal Format: IEC-60958-3 (S/PDIF)

DIGITAL OUTPUT (OPTICAL)

Connector: Optical Jack

Compatible Signal Format: IEC-60958-3 (S/PDIF)

Audio performance

Frequency Response

20 Hz - 20 kHz \pm 1.0 dB (during playback, JEITA)

Signal-to-Noise Ratio (S/N)

More than 90 dB (during playback, JEITA)

Total Harmonic Distortion

Less than 0.01% (during playback, JEITA)

Dynamic Range

More than 90 dB (during playback, JEITA)

Channel Separation

More than 90 dB (during playback, JEITA)

Backup memory

The following settings are backed up even when the unit power is turned off.

- Time and title display settings
- Playback mode
- Program (CD/SD card/USB flash drive)
- Current folder (CD/SD card/USB flash drive)
- Media selection
- Repeat playback function setting (ON/OFF)
- Pitch control ON/OFF (CD)
- Pitch control value (CD)

General

Power Requirement

AC 120 V, 60 Hz (U.S.A./Canada)
 AC 230 V, 50 Hz (U.K./Europe)
 AC 240 V, 50 Hz (Australia)

Power Consumption

11 W

Dimensions (W x H x D)

481 x 94.5 x 298 (mm) / 18.94 x 3.72 x 11.73 (in)

Weight

4.7 kg (10.36 lb)

Operating Temperature

5 to 35°C

Inclination of installation

5° or less

Dimensions

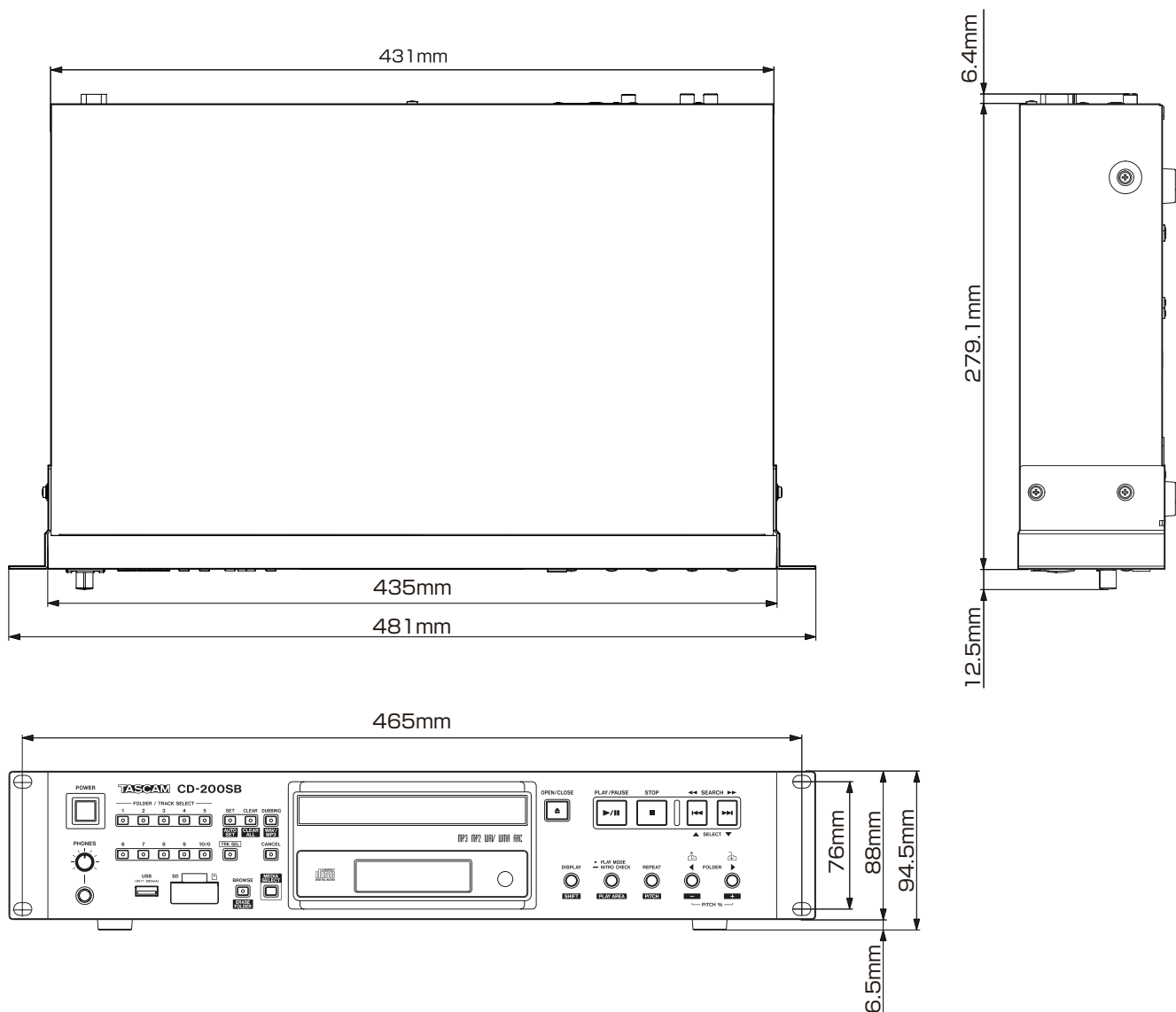

- Illustrations and other depictions may differ in part from the actual product.
- Specifications and external appearance may be changed without notification to improve the product.

TASCAM

CD-200SB

TEAC CORPORATION

Phone: +81-42-356-9143

1-47 Ochiai, Tama-shi, Tokyo 206-8530 Japan

<http://tascam.jp/>

TEAC AMERICA, INC.

Phone: +1-323-726-0303

7733 Telegraph Road, Montebello, California 90640 USA

<http://tascam.com/>

TEAC MEXICO, S.A. de C.V.

Phone: +52-55-5010-6000

Río Churubusco 364, Colonia Del Carmen, Delegación Coyoacán, CP 04100, México DF, México

<http://teacmexico.net/>

TEAC UK LIMITED

Phone: +44-8451-302511

Suites 19 & 20, Building 6, Croxley Green Business Park, Hatters Lane, Watford, Hertfordshire, WD18 8TE, UK

<http://tascam.eu/>

TEAC EUROPE GmbH

Phone: +49-611-71580

Bahnstrasse 12, 65205 Wiesbaden-Erbenheim, Germany

<http://tascam.eu/>