



# Friends



41130



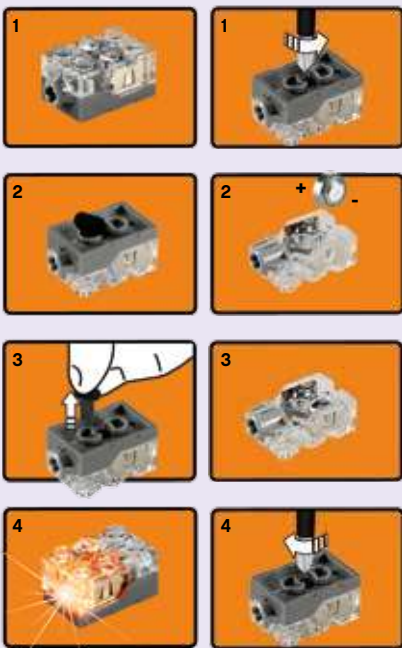

1:1  
2x LR 41 1.5V

## EN

### Important information about batteries

Never use different types of batteries together, or a combination of old and new batteries. Always remove the batteries if the product is not to be used for a long time or if the batteries have run down. Never use damaged batteries. Only use batteries of the type recommended, or a corresponding type. Insert the batteries so that the poles are correctly positioned. Rechargeable batteries must be recharged using the correct battery charger under the supervision of an adult. You cannot recharge batteries while they are still in the product, and you must never try to do so. Never attempt to recharge non-rechargeable batteries. Never short-circuit the battery holder.

## DE

### Wichtige Informationen zu Batterien

Benutzen Sie niemals unterschiedlich Arten von Batterien oder alte und neue gleichzeitig. Nehmen Sie stets die Batterien heraus, wenn mit dem Modell längere Zeit nicht gespielt wird oder wenn die Batterien leer sind. Verwenden Sie niemals beschädigte Batterien. Verwenden Sie ausschließlich empfohlene bzw. geeignete Batterien. Achten Sie beim Einsetzen der Batterien auf die richtige Polung. Wiederaufladbare Batterien sollten mit einem geeigneten Ladegerät aufgeladen werden - unter der Aufsicht eines Erwachsenen. Wiederaufladbare Batterien können und sollten niemals aufgeladen werden, während sie sich im Modell befinden. Versuchen Sie unter keinen Umständen, „normale“ Batterien wieder aufzuladen. Schließen Sie das Batteriefach niemals kurz.

## FR

### Informations importantes concernant les piles

Ne jamais utiliser un mélange de différents types de piles, ou de piles neuves et de piles anciennes ou déjà utilisées. Toujours retirer les piles si le produit n'est pas utilisé durant une période prolongée ou si les piles sont vides. Ne jamais utiliser de piles endommagées. Utiliser uniquement des piles du type recommandé ou d'un type équivalent. En insérant les piles, respecter scrupuleusement le sens d'orientation des pôles (+/-). Les piles rechargeables doivent être rechargées en utilisant un chargeur de piles adéquat et sous la surveillance d'un adulte. Il est impossible de recharger les piles quand elles sont installées dans le produit. Ne jamais tenter de le faire. Ne jamais essayer de recharger des piles non-rechargeables. Ne jamais court-circuiter le compartiment des piles.

## IT

### Importanti informazioni sulle batterie

Non usare mai contemporaneamente batterie di tipo diverso o batterie nuove e usate insieme. Rimuovere sempre le batterie qualora il prodotto non venga utilizzato per periodi prolungati, oppure se le batterie sono esauste. Non utilizzare mai batterie danneggiate. Usare esclusivamente batterie del tipo raccomandato o un equivalente. Inserire le batterie avendo cura che la loro polarità sia corretta. Le batterie ricaricabili vanno ricaricate in un caricabatterie di tipo idoneo e con la supervisione di un adulto. Non è possibile e non bisogna mai tentare di ricaricare le batterie mentre queste sono inserite nel prodotto. Non tentare mai di ricaricare batterie non ricaricabili. Non cortocircuitare mai il portabatterie.

## NL

### Belangrijke informatie over batterijen

Gebruik nooit verschillende soorten of een combinatie van oude en nieuwe batterijen tegelijkertijd. Verwijder de batterijen altijd als je het product lange tijd niet wilt gebruiken of als batterijen leeg zijn. Gebruik nooit beschadigde batterijen. Gebruik uitsluitend batterijen van het aanbevolen type of een overeenkomstig type. Plaats de batterijen met de polen in de juiste richting. Oplaadbare batterijen moeten in een voor dit doel bestemde oplader en onder toezicht van een volwassene opnieuw worden opgeladen. Opladbare batterijen kunnen niet worden opgeladen terwijl ze zich nog in het product bevinden en dit mag ook nooit worden geprobeerd. Probeer nooit niet-oplaadbare batterijen opnieuw op te laden. Laat de batterijhouder nooit kortsluiten.

## ES

### Información importante acerca de las pilas

No use pilas de diferentes tipos ni pilas nuevas y antiguas para alimentar el producto. Extraiga las pilas del producto si este va a permanecer sin uso durante un período prolongado de tiempo o aquellas se han agotado. No use pilas dañadas. Use sólo pilas del tipo recomendado u otro equivalente. Inserte las pilas de modo que los polos queden situados en las posiciones correctas. La carga de pilas recargables debe tener lugar empleando un cargador apropiado y bajo la supervisión de un adulto. Las pilas recargables no se pueden cargar mientras permanecen insertadas en el producto; no intente hacerlo. No trate de cargar pilas no recargables. No cortocircuite el compartimento de las pilas.

## DA

### Vigtige oplysninger om batterier

Brug aldrig forskellige batterityper sammen eller en kombination af gamle og nye batterier. Fjern altid batterierne, hvis produktet ikke skal bruges i lang tid, eller hvis batterierne er flade. Brug aldrig beskadigede batterier. Brug kun den anbefalede type batterier eller en tilsvarende type. Sæt batterierne i, så polerne vender den rigtige vej. Genopladelige batterier skal oplades i den rigtige batterioplader. Batterierne skal sættes i opladeren under opsyn af en voksen. Batterierne kan ikke oplades, mens de stadig sidder i produktet, og man må aldrig forsøge at gøre det. Forsøg aldrig at oplade ikke-genopladelige batterier. Kortslut aldrig batteriholderen.

## IS

### Mikilvægar upplýsingar um rafhlöður

Aldrei skal nota mismunandi gerðir rafhlöðna samtímis, né nýjar og eldri rafhlöður samtímis. Ef ekki á að nota tækið í lengri tíma eða ef rafhlöðurnar eru orðnar tómar skal fjarlægja rafhlöðurnar. Aldrei skal nota rafhlöður sem hafa skemmt. Aðeins skal nota rafhlöður af þeirri gerð sem mælt er með, eða samsvarandi gerð. Setja skal rafhlöðurnar í þannig að + og - skaut þeirra snúi rétt. Endurhláðanlegar rafhlöður skal endurhláða með réttu hleðslutæki undir eftirliti fullorðinna. Rafhlöður er ekki hægt að endurhláða á meðan þær eru enn í vörnni og það má aldrei reyna að gera það. Aldrei skal reyna að endurhláða rafhlöður sem ekki eru endurhláðanlegar. Aldrei ætti að valda skammhlaupi í rafhlöðuhöfnu.

## FI

### Tärkeää tietoa paristoista

Älä koskaan käytä erityyppisiä paristoja yhdessä. Älä myöskään käytä samassa laitteessa sekä vanhoja että uusia paristoja. Poista paristot tuotteesta aina, kun se on pitemmän aikaa käyttämättä, tai kun paristot ovat tyhjentyneet. Älä koskaan käytä viallisia paristoja. Käytä vain tuotteessa suositeltuja tai vastaavantyyppisiä paristoja. Aseta paristot siten, että navat osoittavat oikeaan suuntaan. Ladattavat paristot on ladattava oikeanlaisella laturilla aikuisen valvonnassa. Ne on poistettava tuotteesta lataamisen ajaksi. Älä koskaan yritä ladata paristoja, joita ei ole tarkoitettu ladattaviksi. Älä koskaan aiheuta oikosulkua pariston kosketintien välillä.

## SV

### Viktig information om batterier

Använd aldrig olika sorters batterier samtidigt, och inte heller en kombination av gamla och nya batterier. Ta alltid ur batterierna om produkten inte ska användas under en längre tid eller om batterierna är slut. Använd aldrig skadade batterier. Använd bara batterier av den typ som rekommenderas, eller av en motsvarande typ. Sätt i batterierna så att polerna hamnar i rätt läge. Laddningsbara batterier måste laddas med rätt slags batteriladdare och under en vuxens överinseende. Du kan inte ladda batterierna medan de fortfarande sitter i produkten, och du får heller aldrig försöka göra det. Försök aldrig ladda icke laddningsbara batterier. Kortslut aldrig batteriutrymmets kontaktytor.

## NO

### Viktig informasjon om batterier

Bruk aldri ulike typer batterier sammen og heller aldri gamle og nye batterier sammen. Ta alltid ut batteriene hvis produktet ikke skal brukes på lang tid, eller hvis batteriene er brukt opp. Bruk aldri skadde batterier. Bruk kun anbefalt type batterier eller tilsvarende type. Sett inn batteriene med polene vendt riktig vei. Opladbare batterier skal lades opp med riktig batterilader, under overoppsyn av en voksen. Det er ikke mulig å lade opp batteriene mens de fremdeles er i produktet, og du må aldri forsøke å gjøre det. Forsøk aldri å lade opp ikke-opladdbare batterier. Kortslett aldri batteriholderen.

## PT

### Informação importante sobre as pilhas

Nunca use diferentes tipos de pilhas em simultâneo, ou uma combinação de pilhas usadas e novas. Retire sempre as pilhas se o produto não for usado durante muito tempo ou se as pilhas já não tiverem carga. Nunca use pilhas danificadas. Use apenas pilhas do tipo recomendado ou de um tipo correspondente. Insira as pilhas de forma a que os pólos fiquem corretamente posicionados. As pilhas recarregáveis devem ser recarregadas com o carregador de pilhas correto e sob a supervisão de um adulto. Não pode recarregar as pilhas enquanto as mesmas se encontram colocadas no produto e nunca deve tentar fazê-lo. Nunca tente recarregar pilhas não recarregáveis. Nunca deixe o compartimento das pilhas entrar em curto-circuito.

## EL

### Σημαντικές πληροφορίες για τις μπαταρίες

Μην χρησιμοποιείτε ποτέ διαφορετικούς τύπους μπαταριών μαζί και μην συνδυάζετε παλιές και καινούργιες μπαταρίες. Αφαιρείτε πάντα τις μπαταρίες αν δεν σκοπεύετε να χρησιμοποιήσετε το προϊόν για αρκετό καιρό ή αν οι μπαταρίες έχουν αδειάσει. Ποτέ μην χρησιμοποιείτε μπαταρίες που έχουν φθορές. Χρησιμοποιείτε μόνο μπαταρίες του συνιστώμενου τύπου ή κάποιου αντίστοιχου τύπου. Τοποθετήστε τις μπαταρίες με τους πόλους στη σωστή θέση. Οι επαναφορτιζόμενες μπαταρίες πρέπει να επαναφορτίζονται χρησιμοποιώντας το σωστό φορτιστή μπαταριών υπό την επίβλεψη ενηλίκου. Δεν μπορείτε να επαναφορτίσετε τις μπαταρίες όταν αυτές βρίσκονται μέσα στο προϊόν και δεν πρέπει ποτέ να δοκιμάσετε κάτι τέτοιο. Μην επιχειρήσετε ποτέ να επαναφορτίσετε μη επαναφορτιζόμενες μπαταρίες. Ποτέ μην βραχυκυκλώνετε τη θήκη των μπαταριών.

## JA

### 電池取扱いに関する重要事項

異なるタイプの電池や古い電池を混ぜて使用しないでください。商品を長時間使用しないときや電池が切れたときは、電池を必ず取り外してください。不具合のある電池は、絶対に使用しないでください。推奨されているタイプまたは対応しているタイプの電池を必ず使用してください。電極を確認して電池を正しい向きに入れてください。充電式電池は、保護者に見てもらった上で適切な充電器を使って充電してください。電池を商品の中にいれたまま充電することは絶対に避けてください。充電式ではない電池は絶対に充電しないでください。電池ホルダをショートさせないでください。

## ZH

### 关于电池的重要信息

请勿同时使用不同类型的电池，或把新旧程度不同的电池混合使用。如果产品将有很长时间不会使用，或者电池已经没电，请注意取出电池。切勿使用已破损的电池。务必仅使用推荐类型或兼容类型的电池。装入电池时请注意正负极。如果使用充电电池，务必在成人监护下使用正确的电池充电器进行充电。电池仍在产品中时不可进行充电，请勿强行尝试充电。请勿尝试给非充电电池充电。切勿对电池仓进行短路连接。

## KO

### 배터리 사용 시 주의사항

다른 종류의 배터리를 함께 사용하거나, 새 전지와 오래된 전지를 혼용하지 마세요. 배터리가 방전되었거나 장기간 제품을 작동하지 않을 때에는 반드시 배터리를 분리하세요. 파손된 배터리는 사용하지 마세요. 레고에서 권장하는 유형의 배터리만 사용하세요. 양극과 음극의 위치를 잘 맞춰서 넣으세요. 어른의 감독에 따라 지정된 충전기에 충전지를 충전해야 합니다. 충전지를 제품에 넣은 상태로 충전하면 안 됩니다. 일만 배터리는 충전해서 사용할 수 없습니다. 배터리 홀더의 접촉부에 배터리를 정확히 끼워서 사용하세요.

## RU

### Необходимая информация

#### об элементах питания

Ни в коем случае не используйте одновременно элементы питания различных типов, а также элементы питания с разным сроком годности. В обязательном порядке внимательно элементы питания из терминалов в случае, если вы не пользуетесь прибором в течение долгого времени, либо в случае, если в элементах питания закончился заряд. Ни в каком случае не используйте поврежденные элементы питания. Используйте только рекомендуемые элементы питания либо элементы питания соответствующего типа. Установите элементы питания, соблюдая указанную полярность. Аккумуляторные элементы питания должны подзаряжаться в соответствующем зарядном устройстве под наблюдением взрослого. Ни в коем случае не пытайтесь подзаряжать элементы питания, находящиеся в приборе. Ни в коем случае не пытайтесь подзаряжать перезаряжаемые элементы питания. Ни в коем случае не пытайтесь замкнуть полюса в устройстве для элементов питания.

## PL

### Ważne informacje dotyczące baterii

Nigdy nie należy stosować razem różnych rodzajów baterii ani stosować równocześnie starych i nowych baterii. Jeżeli produkt nie jest używany przez dłuższy czas lub jeżeli baterie się wyczerpały, należy wyjąć baterie. Nigdy nie należy stosować uszkodzonych baterii. Należy stosować wyłącznie zalecany rodzaj baterii lub rodzaj mi odpowiadający. Przy wkładaniu baterii należy zwrócić uwagę na właściwe położenie biegunów. Baterie akumulatorowe należy ładować w odpowiedniej ładowarce pod nadzorem osoby dorosłej. Nie można naładować baterii bez wyjścia ich z produktu i nigdy nie należy tego próbować. Nigdy nie należy próbować ładowania baterii jednorazowych. Nigdy nie należy doprowadzać do zwarcia w gnieździe baterii.

## CZ

### Vážné informace o bateriích

Nikdy nepoužívejte najednou různé typy baterií nebo kombinaci starých a nových baterií. Nebude-li se výrobek delší dobu používat nebo jsou-li baterie vybité, vždy je vyjměte z výrobku. Nikdy nepoužívejte poškozené baterie. Používejte pouze doporučené nebo odpovídající typy baterií. Baterie instalujte se správnou orientací pólů. Nabíjecí baterie musí být nabitý ve vhodné nabíječce pod dohledem dospělé osoby. Nabíjecí baterie nelze nabíjet, jsou-li umíštěny ve výrobku, a nesmíte se o to ani pokoušet. Nikdy se nesnažte nabíjet baterie, které nejsou nabíjecí. Nikdy neskratujte kontakty v prostoru pro baterie.

## SK

### Dôležitá informácia o batériách

Nikdy nepoužívajte naraz odlišné typy batérií ani nekombinujte staré batérie s novými. Batérie vždy vyberte, ak sa výrobok nebude dlhšie používať, alebo ak sa batérie vybili. Nikdy nepoužívajte poškodené batérie. Používajte jen odporúčané alebo zodpovedajúce typy batérií. Batérie vkladajte so správnou orientáciou pólou. Nabíjacie batérie sa musia nabíjať vo vhodnej nabíjačke pod dozomom dospeléj osoby. Nabíjacie batérie sa nesmú nabíjať, ak sú umiestnené vo výrobku, a nesmiete sa o to ani pokúšať. Nikdy sa nesnažte nabíjať batérie, ktoré nie sú nabíjacie. Nikdy neskratujte kontakty v priestore pre batérie.

## HU

### Fontos tudnivalók az elemekről

Soha ne használjon különböző típusú elemeket, illetve ne használjon vegyesen új és használt elemeket. Mindig távolítsa el az elemeket, ha a készüléket előre láthatóan hosszabb ideig nem fogják használni, vagy ha az elemek lemerültek. Soha ne használjon megrongálódott elemeket. Csak az ajánlott típusú, vagy annak megfelelő elemet használjon. Az elemeket helyesen helyezze be, a polaritásuknak megfelelően. Az akkumulátorokat csak a megfelelő akkumulátor- töltővel szabad feltölteni, felhőtt felügyelete mellett. Az akumulá- torokat nem lehet feltölteni, ha azok a készülékben vannak. Ezt meg sem szabad próbálni. Soha ne próbálja meg feltölteni a nem tölthető elemeket. Soha ne hozzon létre rövidzárlatot az elemtartó kivezetéséin.

## UA

### Необхідна інформація про батареї

Ніколи не використовуйте одночасно батареї різних типів або батареї зo різним терміном придатності. Обов'язково вилучайте батареї з приладу, якщо довог не користуетесь ним, або якщо в батареї вже скінчився заряд. Ніколи не використовуйте пошкоджені батареї. Використовуйте батареї лише рекомендованого або відповідного типу. Вставляйте батареї, враховуючи задану полярність. Аккумуляторні батареї повинні заряджатись у відповідному зарядному приладі під наглядом дорослого. В будь-якому випадку не намагайтеся підзарядити батареї, що знаходяться в приладі. В будь-якому випадку не намагайтеся підзарядити батареї, що не підлягають підзарядці. В будь-якому випадку не намагайтеся зробити коротке замикання в приладі для батерей.

## HR

### Vážne obavijesti o bateriji

Nikada nemoj koristiti različite vrste baterija zajedno, isto tako ni kombinaciju starih i novih baterija. Uvijek izvadite baterije ako dugo nećeš koristiti proizvod ili ako su one potrošene. Nikada nemoj koristiti oštećene baterije. Koristi samo preporučenu vrstu ili odgovarajuću vrstu baterija. Umetni baterije pažeci da dobro okreneš polove. Akumulatorske se baterije moraju puniti uz pomoć propisanog punjača i uz nadzor odrasle osobe. Baterije se ne smiju puniti dok su još u proizvodu i to nikada nemoj pokušavati. Nikada ne pokušavaj puniti baterije koje nisu predviđene za punjenje. Nikada ne izazivaj kratki spoj u držaču baterija.

## SR

### Важне информације о батеријама

Никада не користите различите типове батерија заједно нити комбинацију старих и нових батерија. Увек извадите батерије уколико производ нећете дуже време користити или уколико су батерије празне. Никада не користите оштећене батерије. Употребљавајте само препоручени тип батерија или одговарајућу замену. Ставите батерије тако да су полови правилно позиционисани. Батерије на пуњење се морају пунити одговарајућим пуњачем под надзором одраслог лица. Није могуће пунити батерије док су у производу и никад не покушавајте да радите то. Никада не покушавајте да пуните батерије које не могу да се пуне. Никада не изазивајте кратак спој у кућишту за батерије.

## MK

### Важни информации за батериите

Никогаш не користете различни типови батери заедно или комбинација од стари и нови батери. Секогаш отстранувајте ги батериите доколку не го користите производот подоого време или доколку се потрошиле. Никогаш не користете оштетени батери. Користете ги само препорачаните батери или батери од соодветен тип. Вметнете ги батериите така што точно ќе ги наместите половите. Батериите на полнење мора да се полнат со соодветниот полнач под надзор на возрастно лице. Не може да ги полните батериите додека сè уште се наоѓаат во производот и никогаш не смеете да го правите тоа. Никогаш не обидувајте се да ги полните батериите за еднократна употреба. Никогаш не предизвикувајте краток спој на држачот за батерии.

## SL

### Pomembne informacije o baterijah

Nikoli ne uporabljajte skupaj različnih baterij ali kombinacije starih in novih baterij. Vedno odstranite baterije, če izdelka dlje časa ne boste uporabljali ali če so iztrošene. Nikoli ne uporabljajte poškodovanih baterij. Uporabljajte le baterije priporočenege ali ustreznega tipa. Baterije vstavite tako, da so njihovi poli pravilno obrnjeni. Akumulatorske baterije je treba polniti s prvim polnilnikom pod nadzorom odrasle osebe. Akumulatorskih baterij ni mogoče polniti, dokler so še v izdelku. Tega tudi ne smete poskušati. Nikoli ne poskušajte polniti baterij, ki niso akumulatorske. Pazite, da ležišč za baterije ne boste spravili v kratek stik.

## RO

### Informații importante despre baterii

Nu folosiți niciodată împreună tipuri diferite de baterii, sau o combinație de baterii vechi și noi. Îndepărtați întotdeauna bateriile dacă produsul nu este folosit timp îndelungat sau dacă bateriile s-au epuizat. Nu folosiți niciodată baterii deteriorate. Folosiți numai baterii de tipul recomandat, sau un tip corespunzător. Introduceți bateriile astfel ca polișii să fie poziționați corect. Bateriile reincărcabile trebuie reincărcate utilizând încărcătorul corect sub supravegherea unui adult. Nu puteți reincărca bateriile în timp ce acestea sunt încă în produs, și niciodată nu trebuie să încercați să faceți acest lucru. Nu încercați niciodată să reincărcați baterii nereîncărcabile. Nu scurcircuitați niciodată suportul bateriei.

## BG

### Важна информация за батериите

Никога не използвайте едновременно различни типове батери или комбинация от стари и нови батери. Винаги изваждайте батериите, ако izdelieto няма да се използва продължително време или ако батериите са се изтозили. Никога не използвайте повредени батери. Използвайте само батери от препоръчвания тип или съответстващ на негов тип. Поставайте батериите така, че полюсите да са разположени правилно. Аккумуляторните батери трябва да се зареждат с подходящо зареждащо устройство под надзора на възрастни. Батериите не могат да се зареждат, докато са поставени в izdelieto, затова никога не опитвайте да правите това. Никога не опитвайте да зареждате батери, които не са акумулаторни. Никога не свързвайте на късо контактите на отделението за батериите.

## LV

### Svarīga informācija par baterijām

Nekad vienlaikus nelietojiet dažādu tipu, kā arī vecas un jaunas baterijas. Vienmēr izņemiet baterijas, ja tās ir izlādējušās vai ja produkts ilgāku laiku netiek lietots. Nekad nelietojiet bojātas baterijas. Lietojiet tikai ieteicamā tipa vai atbilstoša tipa baterijas. Ievietojiet pareizu polaritāti. Uzlādējamu bateriju lādēšanai izmantojiet atbilstošo bateriju lādētāju; uzlāde jāveic pieaugušo uzraudzībā. Baterijas nevar uzlādēt un nekad nedrīkst mēģināt uzlādēt, kamēr tās lievietotas produktā. Nekad nemēģiniet uzlādēt baterijas, kas nav uzlādējamas. Nepieļaujiet īssavienojumu bateriju nodalījumā.

## ET

### Oluline teave patareide kohta

Ära kunagi kasuta koos erinevat tüüpi patareiseid, samuti vanu ja uusi patareiseid. Kui mänguasja ei kasutata pika aja jooksul, võta patarei sellest välja. Ära kunagi kasuta kahjustatud patareiseid. Kasuta ainult ettenähtud tüüpi või nendega samaväärseid patareiseid. Pane patareid mänguasja sisse nii, et pluss- ja miinuslemmi asend oleks õige. Akusid tuleb laadida ainult neile ettenähtud akulaadija abil täiskasvanu järelevalve all. Akusid ei saa laadida sel ajal, kui need on mänguasja sees. Ära kunagi püüa nii teha. Ära kunagi proovi akulaadijaga laadida talvisi patareiseid. Patareipesa klemmide vahel ei tohi tekkida lühist.

## LT

### Svarbi informacija apie elementus

Vienu metu nenaudokite skirtingų elementų, taip pat su naujais elementais nenaudokite senų. Jei nenaudosite gaminio ilgesnį laiką arba jei elementai išsekę, visuomet išimkite juos iš gaminio. Niekada nenaudokite pažeistų elementų. Naudokite tik rekomenduojamo arba atinkamo tipo elementus. Elementus dėkite atsižvelgdami į jų poliškumą. Elementus galima įkrauti tik tinkamu krovikliu ir prižiūrint suaugusiesiems. Jokiu būdu negalima, ir niekuomet nebandykite, įkrauti elementų neišėmus ju iš gaminio. Niekada nebandykite įkrauti vienkartinį elementų. Saugokitės, kad elementų dėkle nesukeltumėte trumpojo jungimo.

## TR

### Piller hakkında önemli bilgiler

Hiçbir zaman farklı tipte pilleri ya da eski pilleri yeni pilleri bir arada kullanmayın. Ürün uzun süre kullanılmayacaksa ya da piller bitmişse, pilleri ürünün içinden çıkarın. Hiçbir zaman zedelenmiş piller kullanmayın. Sadece önerilen tipte piller ya da bunların dengi olan piller kullanın. Pilleri kutupları doğru konumda olacak şekilde yerleştirin. Şarj edilebilen pilleri doğru pil şarj aletini kullanarak, bir yetişkinin denetiminde şarj edin. Şarj edilebilen pilleri, pil ürünün içindenken şarj edemezsiniz bunu hiçbir zaman yapmayın şarjlaymayın. Hiçbir zaman, şarj edilebilir olmayan pilleri şarj etmeye çalışmayın. Hiçbir zaman pil kutusuna kısa devre yaptırmayın.

## AR

### معلومات مهمة عن البطاريات

يُحظَر استخدام أنواع مختلفة من البطاريات معًا أو مزيج من البطاريات القديمة والجديدة. احرص دائمًا على نزع البطاريات في حال عدم استخدام المنتج لفترة طويلة أو إذا نفدت طاقة البطاريات. تجنّب استخدام البطاريات التالفة. لا تستخدم إلا نوع البطاريات الموصى به أو نوع مماثل. قم بتربّيب البطاريات بحيث تكون الأقطاب في موضعها الصحيح. يجب إعادة شحن البطاريات القابلة لإعادة الشحن باستخدام شاحن البطاريات المناسب وذلك حت إشراف شخص بالغ. لا يمكن إعادة شحن البطاريات وهي لا تزال داخل المنتج. ويجب ألا جرب فعل ذلك يُحظَر إعادة شحن البطاريات غير القابلة لإعادة الشحن. تجنّب إحداث دائرة قصر في حامل البطارية.

## ID

### Informasi penting tentang baterai

Jangan gunakan baterai yang sejenisnya berlainan, atau mencampur baterai lama dan baterai baru. Lepas baterai jika produk tidak akan digunakan untuk waktu lama atau jika baterai sudah lemah. Jangan gunakan baterai yang rusak. Gunakan jenis baterai yang dianjurkan atau yang sejenis. Masukkan baterai dengan posisi kutub yang tepat. Baterai isi ulang harus diisi ulang dengan charger baterai yang sesuai dan di bawah pengawasan orang dewasa. Anda tidak dapat mengisi ulang baterai saat masih terpasang di dalam produk, dan jangan pernah coba melakukannya. Jangan pernah coba mengisi ulang baterai biasa. Jangan pernah membuat arus pendek pada dudukan baterai.

## MS

### Maklumat penting tentang bateri

Jangan guna jenis bateri yang berbeza bersama-sama, atau gabungan bateri baharu dan lama. Tanggalkan bateri jika produk tidak akan digunakan untuk tempoh masa yang lama atau jika bateri telah kehabisan kuasa. Jangan guna bateri yang rosak. Hanya guna jenis bateri yang disyorkan, atau jenis yang berkaitan. Selitkan bateri supaya supaya paksi berada pada kedudukan yang betul. Bateri yang boleh dicaskan semula perlu dicas semula menggunakan pengecas bateri yang betul bawah pengawasan orang dewasa. Anda tidak boleh mengecas bateri semasa bateri masih berada pada produk, dan anda jangan cuba berbuat demikian. Jangan cuba untuk mengecas semula bateri yang tidak boleh dicaskan semula. Jangan pintas litar pemegang bateri.



EN  
Protect the environment by not disposing of this product with your household waste (2002/96/EC). Check with your local authority for recycling advice and facilities.

DE  
Schützen Sie die Umwelt und entsorgen Sie dieses Produkt nicht mit Ihrem Hausmüll (2002/96/EC). Informationen zu Recycling-Möglichkeiten erhalten Sie bei den örtlichen Behörden.

FR  
Protégez l'environnement : ne jetez pas ce produit avec vos autres déchets ménagers (Directive européenne 2002/96/EC). Contactez les autorités locales pour obtenir des informations sur le recyclage et connaître les points de collecte.

IT  
Proteggi l'ambiente! Non smaltire questo prodotto con i rifiuti domestici (2002/96/EC). Per consulenza sul riciclaggio dei rifiuti e le strutture di riciclaggio, rivolgersi alle proprie autorità locali.

NL  
Bescherm het milieu: gooi dit product niet samen met het andere huisvuil weg (2002/96/EC). Raadpleeg de plaatselijke instanties voor locaties van milieustations en advies over hergebruik.

ES  
Proteja el medio ambiente no deshaciéndose de este producto junto con sus residuos domésticos (2002/96/CE). Solicite a su autoridad local consejos e información sobre instalaciones de reciclado.

DA  
Beskyt miljøet! Smid ikke dette produkt ud sammen med husholdningsaffaldet (2002/96/EF). Få vejledning om genbrug og genbrugsstationer hos din kommune.

IS  
Stuðlið að verndun umhverfis með því að farga þessari vöru ekki með heimilissorpi (2002/96/EB). Leitið upplýsinga um endurvinnslu- og förgunarstaði hjá staðaryfirvöldum.

FI  
Tämä tuote on hävitettävä ympäristönsuojelun vuoksi asianmukaisesti talousjätteistä erillään (2002/96/EY). Tietoja keräyspisteiden sijainnista saa kunnan tai kaupungin teknisestä virastosta.

SV  
Skydda miljön genom att inte kasta denna produkt bland ditt hushållsavfall (2002/96/EG). Kontakta din kommun för frågor om återvinning och miljöstationer.

NO  
Beskytt miljøet. Ikke kast dette produktet i husholdningsavfallet (2002/96/EF). Kontakt kommunen for veiledning om gjenbruk og miljøstasjoner.

PT  
Proteja o ambiente não eliminando este produto com o seu lixo doméstico (2002/96/CE). Consulte as autoridades locais para informação sobre reciclagem e sistemas de recolha.

EL  
Προστατέψτε το περιβάλλον. Μην πετάτε αυτό το προϊόν μαζί με τα συνηθισμένα οικιακά απορρίμματα (2002/96/EC). Επικοινωνήστε με τις τοπικές αρχές σχετικά με συμβουλές και εγκαταστάσεις ανακύκλωσης.

JA  
環境保護のため、本製品は家庭ごみとは別に処分してください (2002/96/EC)。リサイクルに関する指示や施設については、お住まいの地方自治体にお問い合わせください。

ZH  
注意保护环境，请勿将本产品与家庭垃圾一起丢弃处理 (2002/96/EC)。请咨询您当地相关部门，了解回收设施与回收建议。

KO  
환경 보호를 위해 이 제품을 생활폐기물과 함께 버리지 마십시오(2002/96/EC). 재활용 방법 및 시설에 관한 사항은 현지 관계 당국에 문의하십시오.

RU  
Защищайте окружающую среду, не утилизируйте этот продукт вместе с бытовым мусором (директива 2002/96/EC). Осведомитесь у местных органов власти о правилах вторичной переработки и утилизации таких отходов.

PL  
Aby chronić środowisko naturalne, nie należy wyrzucać tego produktu wraz z odpadkami z gospodarstwa domowego (2002/96/WE). W celu uzyskania wskazówek dotyczących recyklingu oraz adresów zakładów należy skontaktować się z lokalnym urzędem.



CZ  
Nevyhazujte tento produkt do domácího odpadu, chrňte životní prostředí (2002/96/EC). Zjistěte si prosím u místních úřadů možnosti recyklace a dostupná zařízení.

SK  
Nevyhadzujte tento produkt do domáceho odpadu, chráňte životné prostredie (2002/96/EC). Zistite si prosím na miestnych úradoch možnosti recyklácie a dostupné zariadenia.

HU  
Környezetét óvja, ha ettől a terméktől nem a háztartási hulladékkal együtt válik meg (2002/96/EC). Érdeklődjék a lakóhelyéhez közel eső hatóságnál az újrahasznosítás módjáról és lehetőségeiről.

UA  
Допоможіть захистити довкілля: не утилізуйте цей виріб разом із побутовим сміттям (2002/96/EC). Вказівки з утилізації та відомості про пункти прийому з'ясуйте в місцевих компетентних органах.

HR  
Zaštiti te okoliš tako da ovaj proizvod ne odložite u otpad zajedno s kućanskim otpadom (2002/96/EZ). Od lokalnih vlasti zatražite savjet ili informacije o pogonima za recikliranje.

SR  
Zaštite životnu sredinu tako što nećete odlagati ovaj proizvod sa kućnim otpadom (2002/96/EC). Obratite se lokalnoj ovlašćenoj službi da biste dobili savete o recikliranju i saznali o objektima za reciklazu.

MK  
Zaštite je okolinu tako što nemojte da se oslobodite od proizvoda sa domaćim otpadom (2002/96/EC). Konsultirajte se sa lokalnim vlastima da biste saznali savete i objekte za recikliranje.

SL  
Zaščitite okolje! Okolje varujte tako, da tega izdelka ne zavržete skupaj z gospodinjiskimi odpadki (2002/96/ES). Pri krajevni upravi preverite, kakšne možnosti in kateri obrati za recikliranje obstajajo v vaši okolici.

RO  
Protejați mediul înconjurător și nu vă debarașiți de acest produs împreună cu deșeurile menajere (2002/96/CE). Consultați autoritățile locale pentru îndrumări și facilități de reciclare.

BG  
Защитете околната среда и не изхвърляйте този продукт заедно с битовите си отпадъци (2002/96/EO). Свържете се с местните власти относно съвети и съоръжения за рециклиране.

LV  
Lai saudzētu vidi, neizmetiet šo izstrādājumu kopā ar sadzīves atkritumiem (2002/96/EK). Vērsieties vietējās varas iestādēs, lai noskaidrotu, kur un kā tas nododams pārstrādei.

ET  
Keskonda saate kaitsta nii, et ei kõrvalda seda toodet koos olmejäätmetega (2002/96/EÜ). Nõuandeid toote taaskasutusse võtmise ja ümbertöötlemispunktide kohta saate asjaomaset kohalikult asutuselt.

LT  
Saugokite aplinką – nemeskite šio produkto kartu su buitinėmis atliekomis (2002/96/EB). Atsižvelkite į savo vietos valdžios rekomendacijas dėl pakartotinio panaudojimo ir sąlygas.

TR  
Bu ürünü, evsel atıklarla birlikte atmayarak çevreyi koruyun (2002/96/EC). Geri dönüşüm tavsiyeleri ve tesisler hakkında bilgi için yerel yönetimle iletişim kurun.

AR  
ساهم في حماية البيئة عن طريق عدم التخلص من هذا المنتج مع المخلفات المنزلية. (CE/2002/96). استشر السلطة المحلية للتعرف على إرشادات ومرافق إعادة تدوير المخلفات.

ID  
Jagalah lingkungan dengan tidak membuang produk ini bersama sampah rumah tangga Anda (2002/96/EC). Periksa peraturan pemerintah setempat tentang saran dan fasilitas daur ulang.

MS  
Lindungi persekitaran dengan tidak melupuskan produk ini bersama dengan sisa isi rumah anda (2002/96/EC). Rujuk pihak berkuasa tempatan anda bagi nasihat dan kemudahan kitar semula.



[LEGO.com/brickseparator](https://LEGO.com/brickseparator)

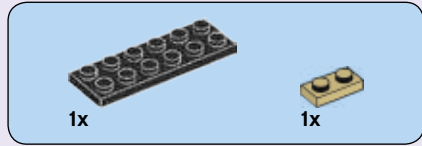
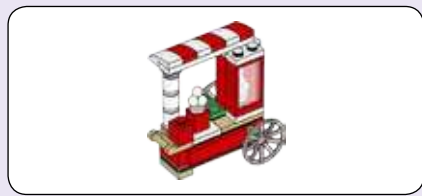
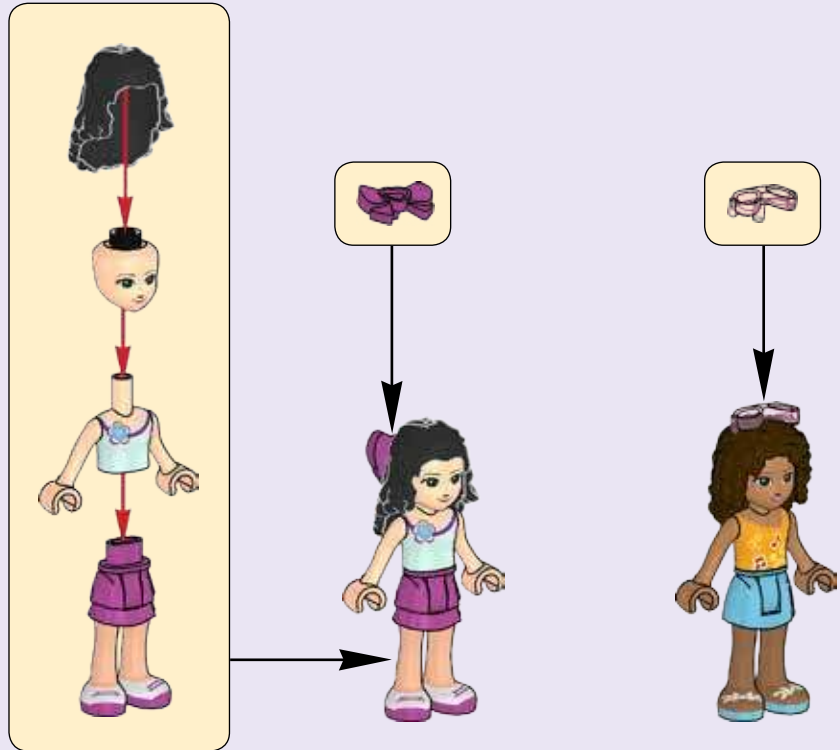
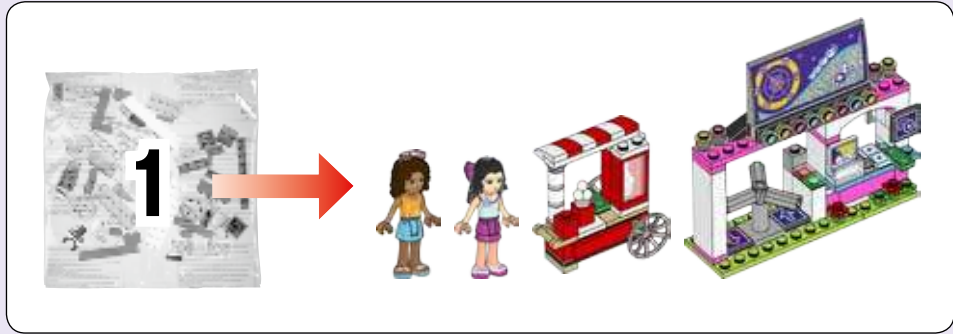

1

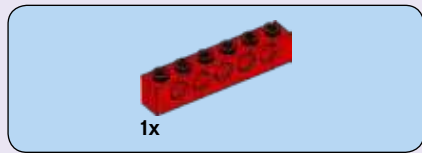
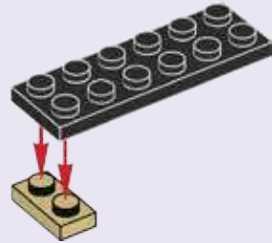

2

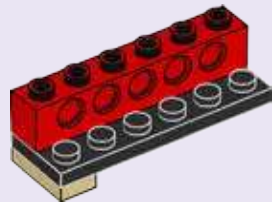

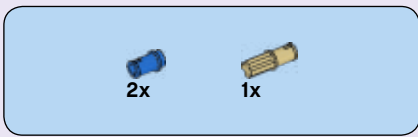

3

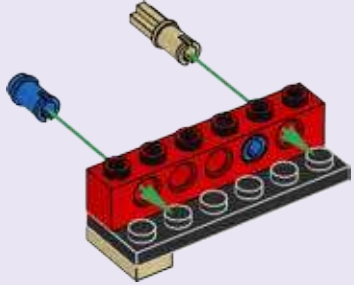

4

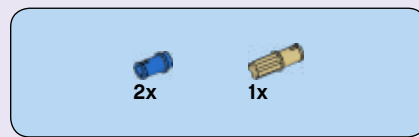

5

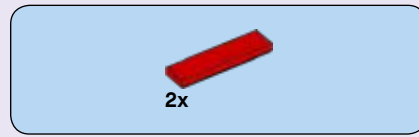
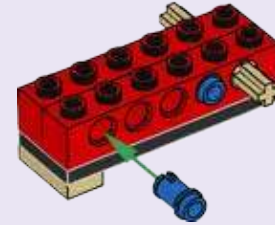

6

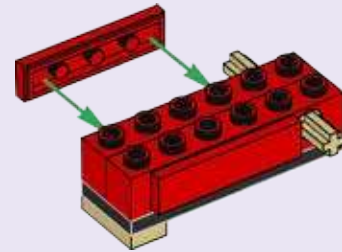

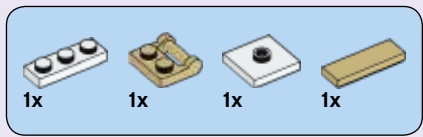

7

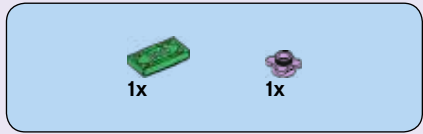
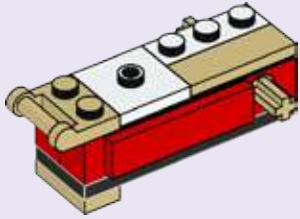

8

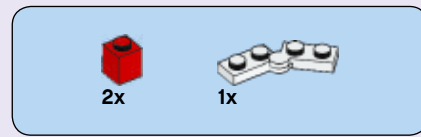
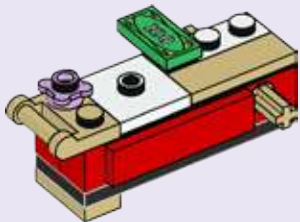

9

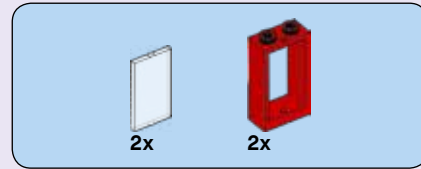
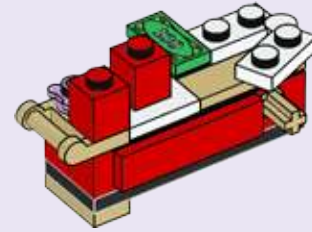

10

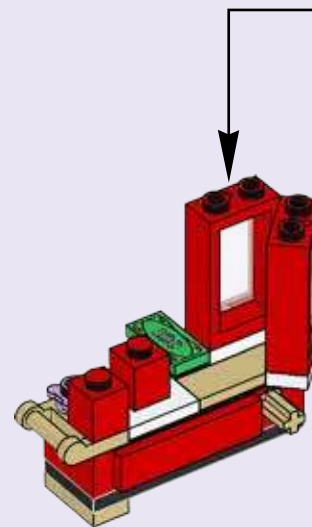
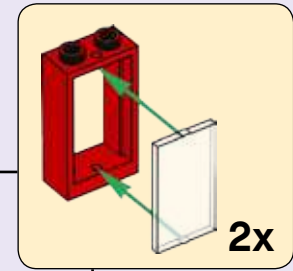



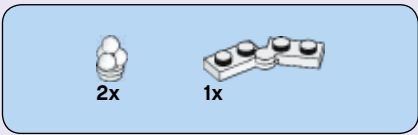

# 11

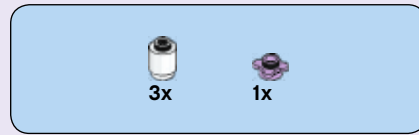
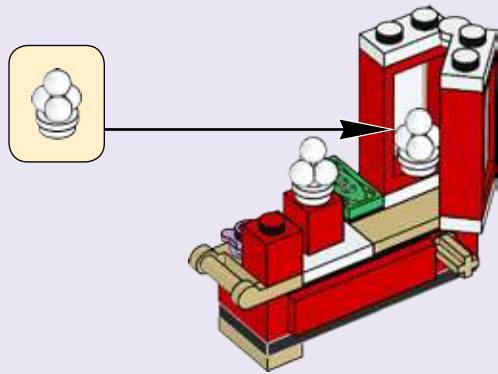

# 12

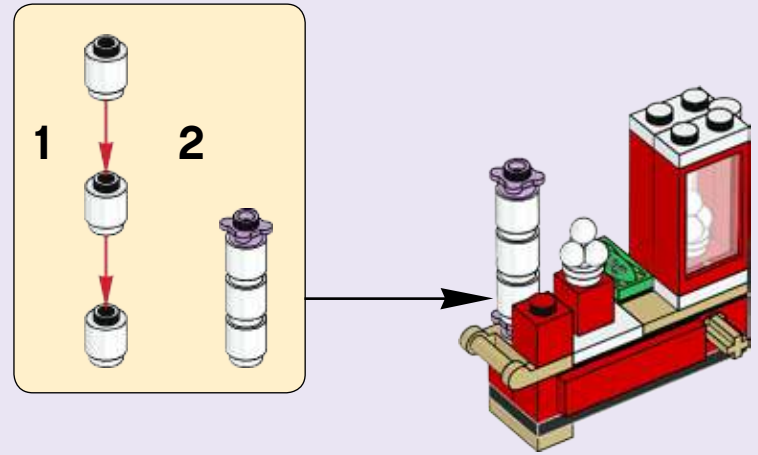

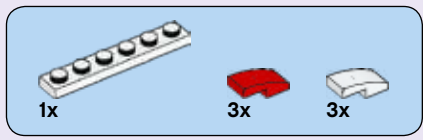

# 13

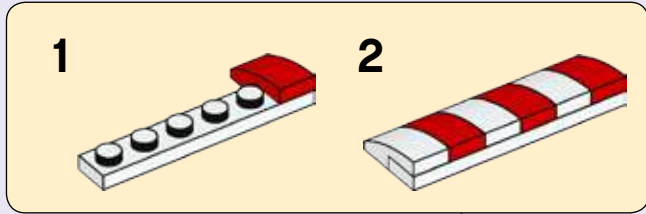

# 14



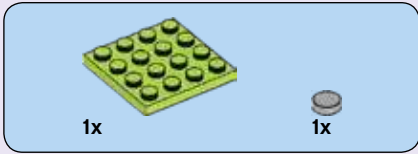
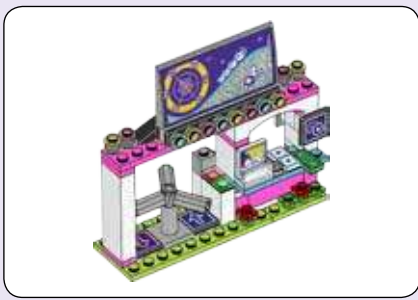

1

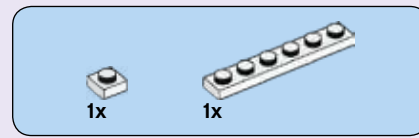
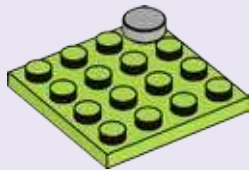

2

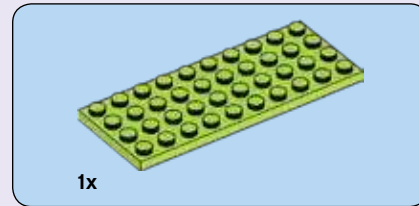
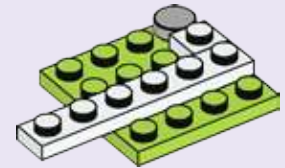

3

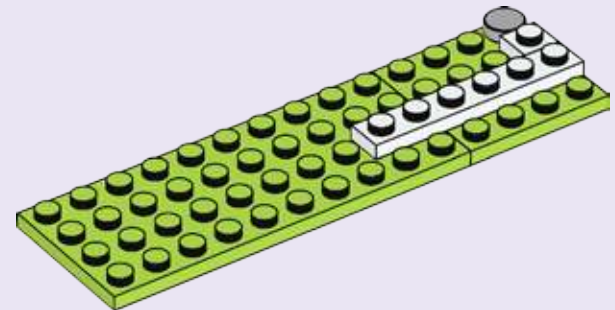

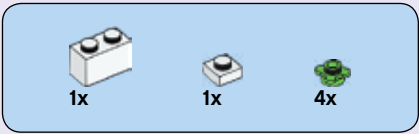

4

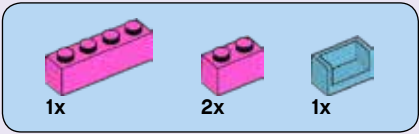
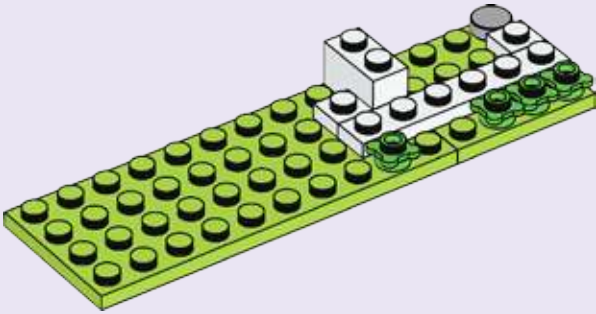

5

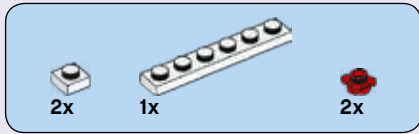
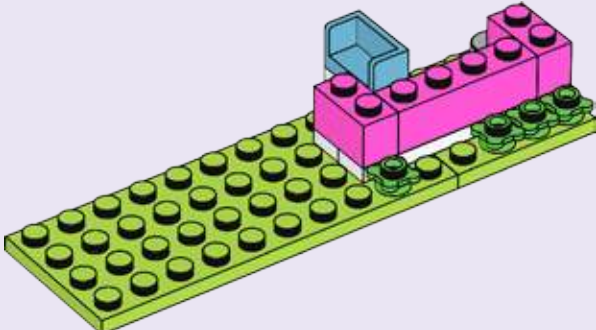

6

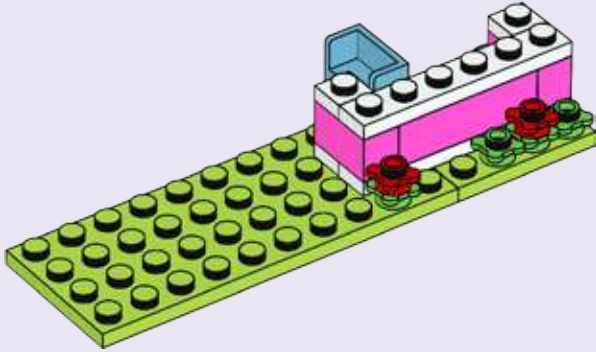

7

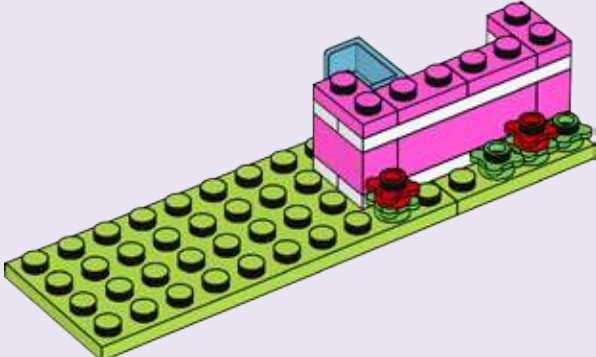



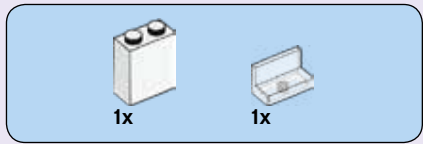

12

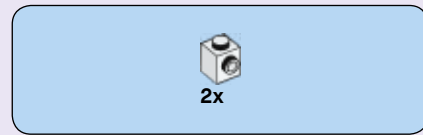
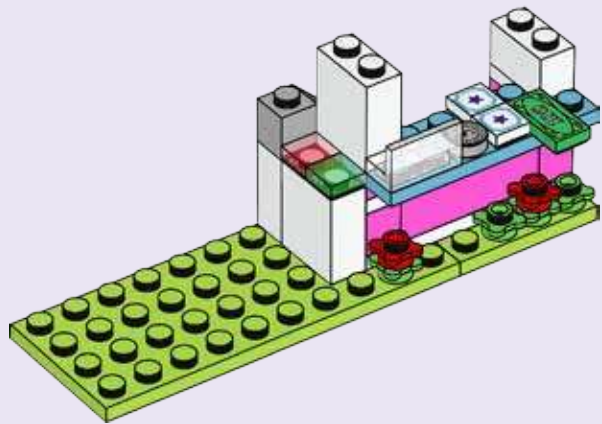

13

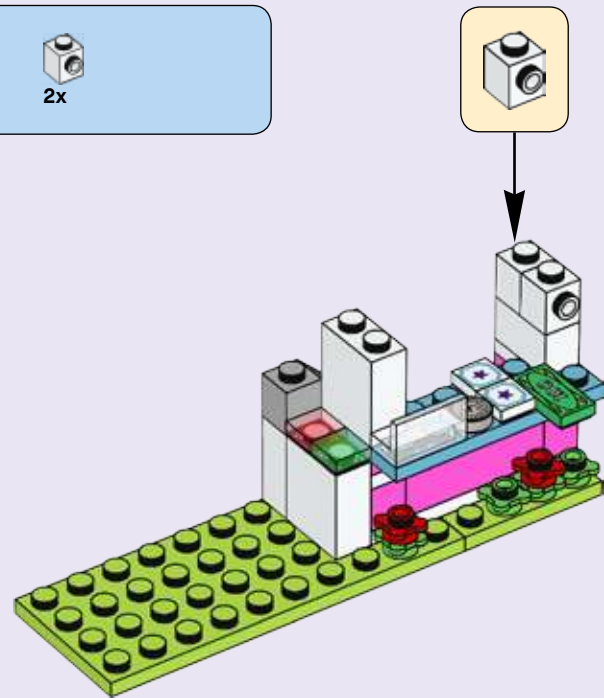

14

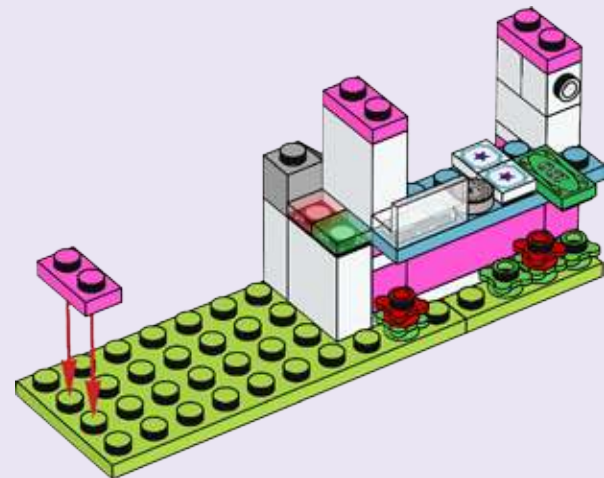

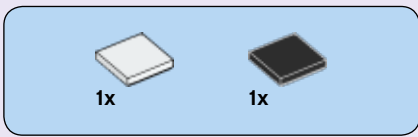

# 15

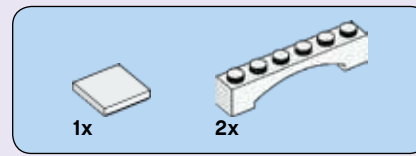
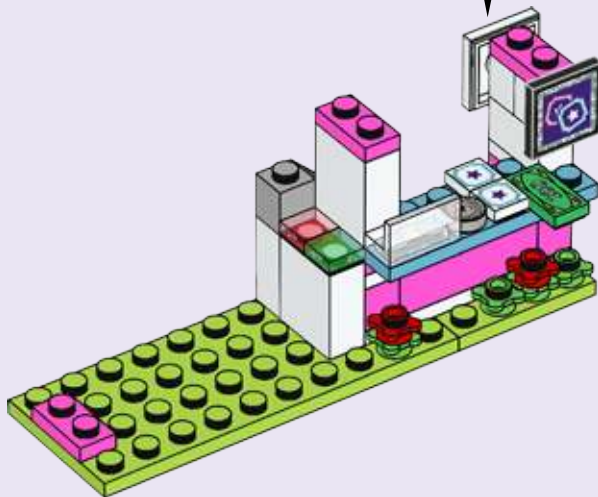
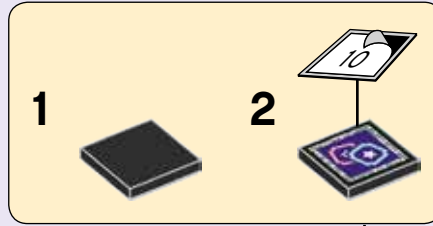
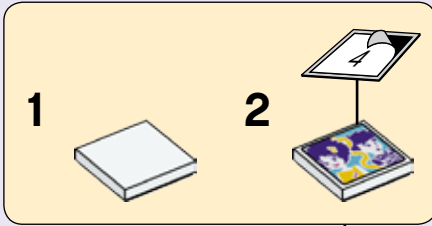

# 16

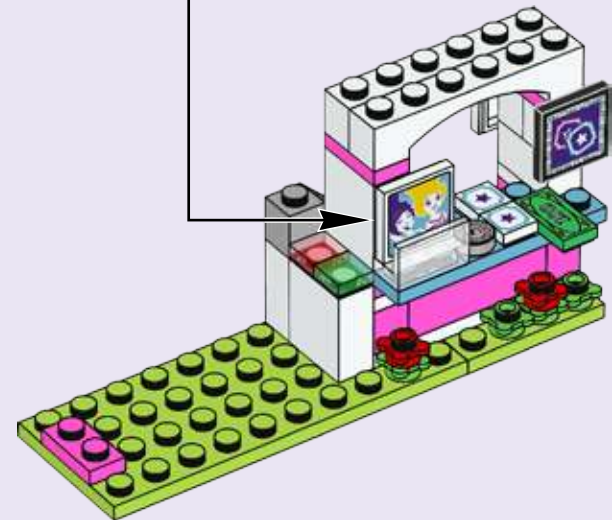
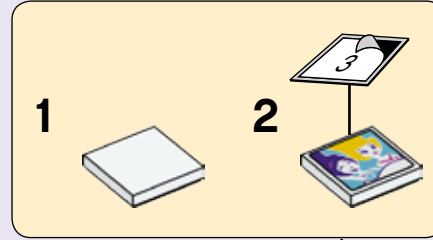

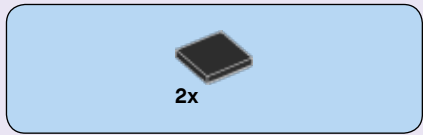

# 17

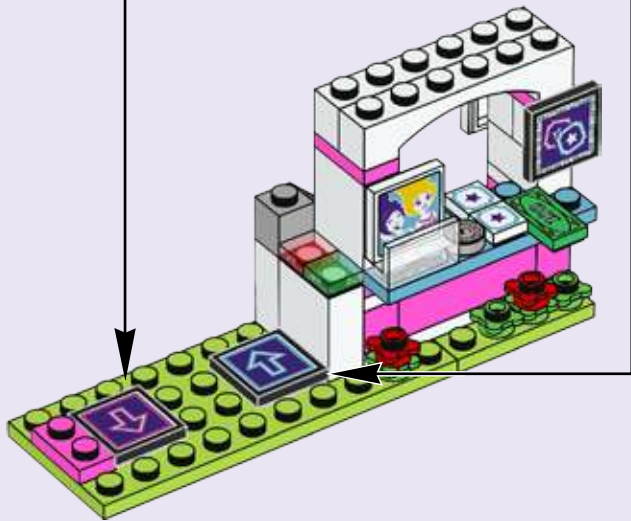
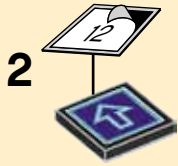
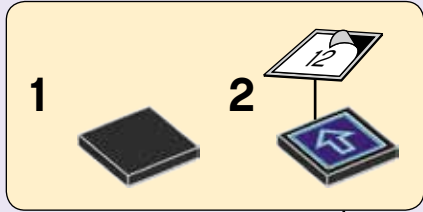
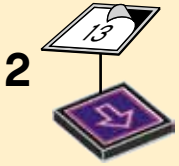
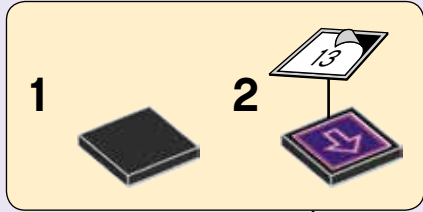

# 18

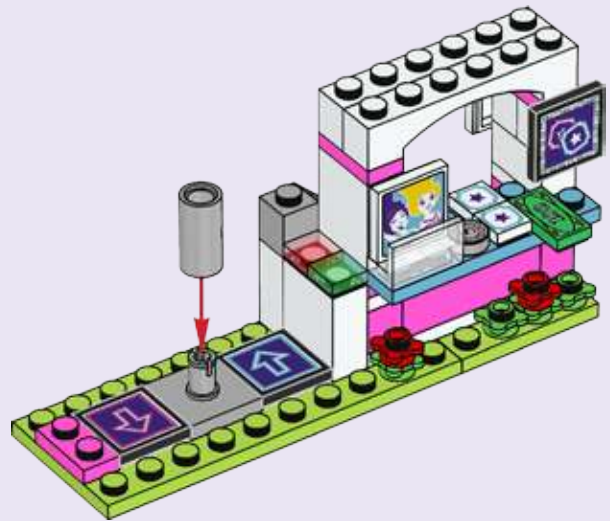



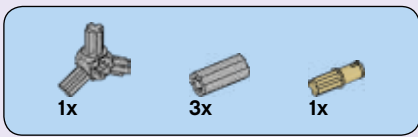

# 19

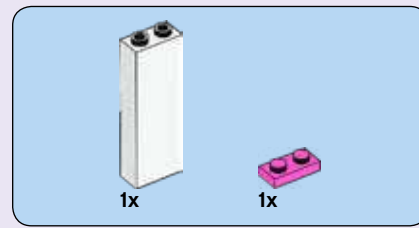
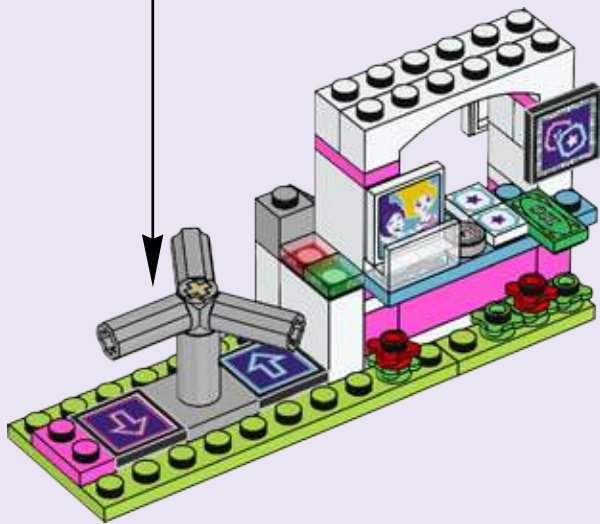
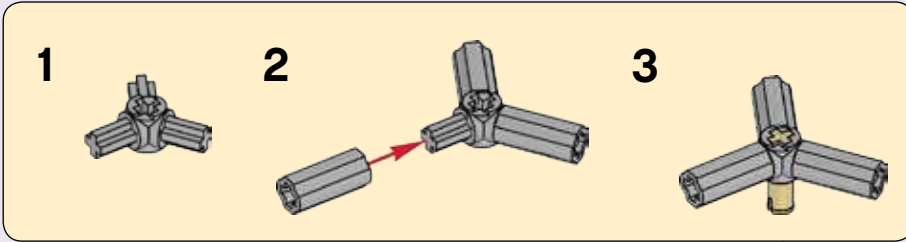

# 20

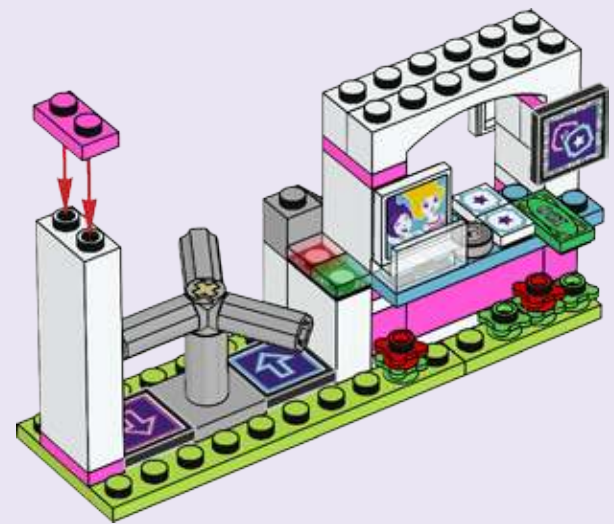

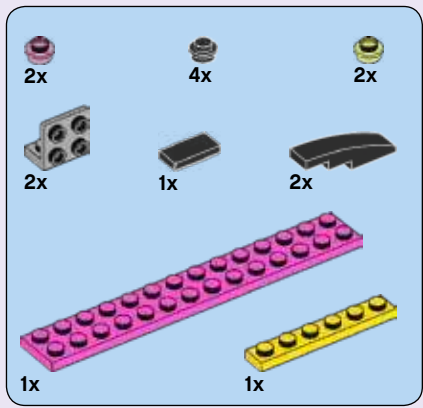

# 21

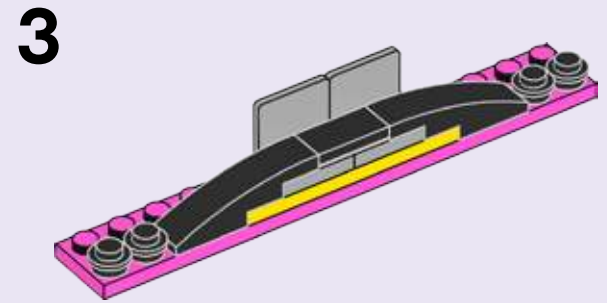
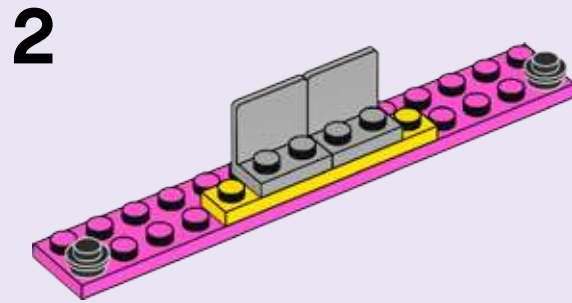
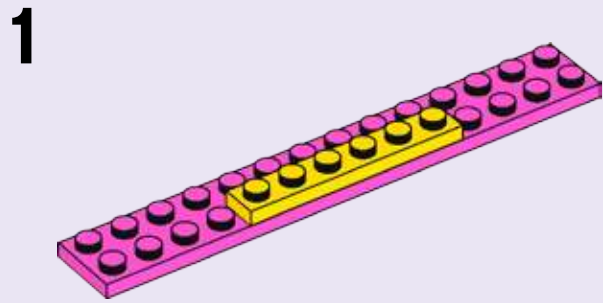

4

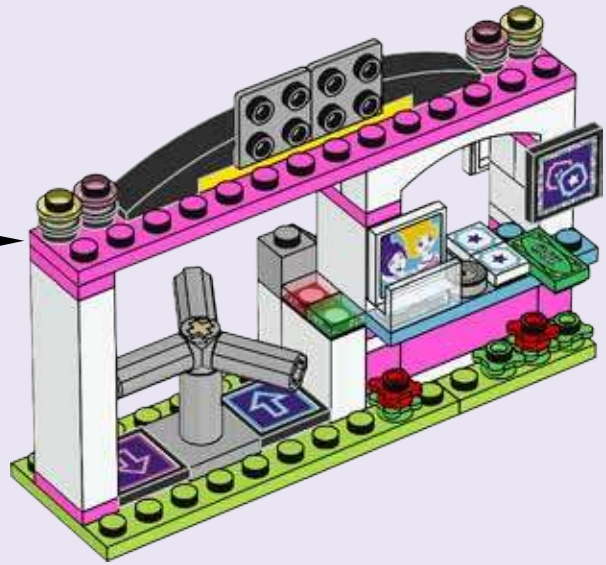
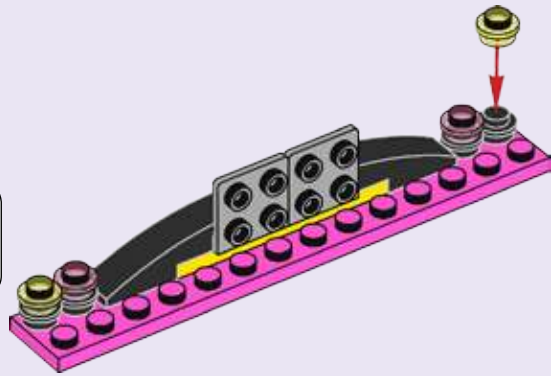
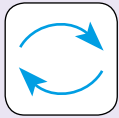

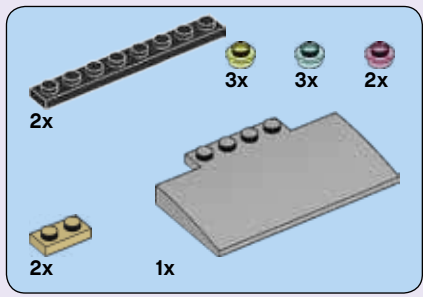

# 22

1

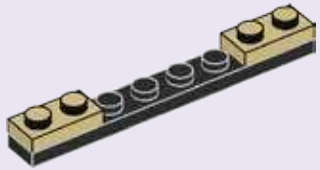

2

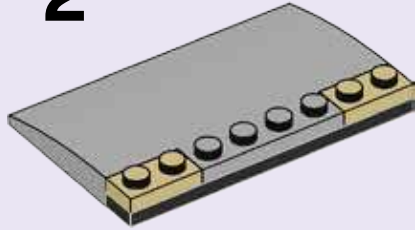

3



4





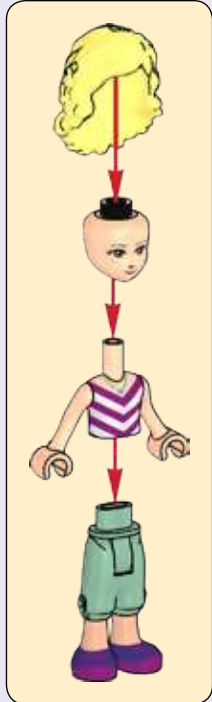

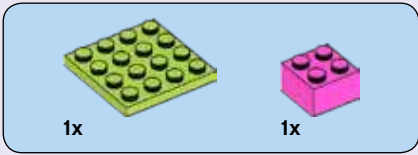

1

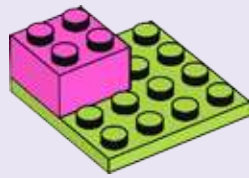

2

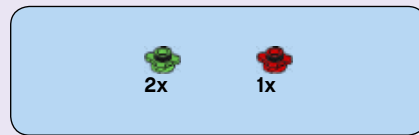
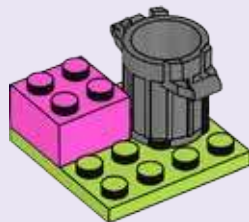

3

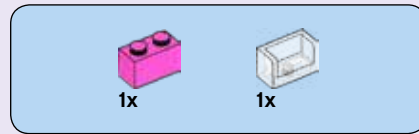
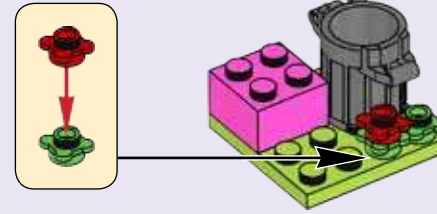

4





5

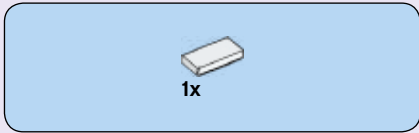

6

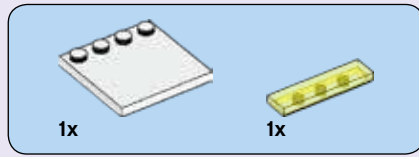
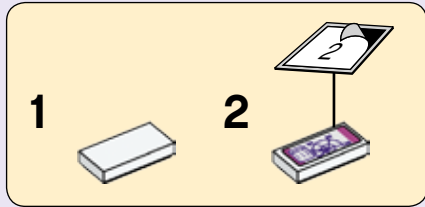

7

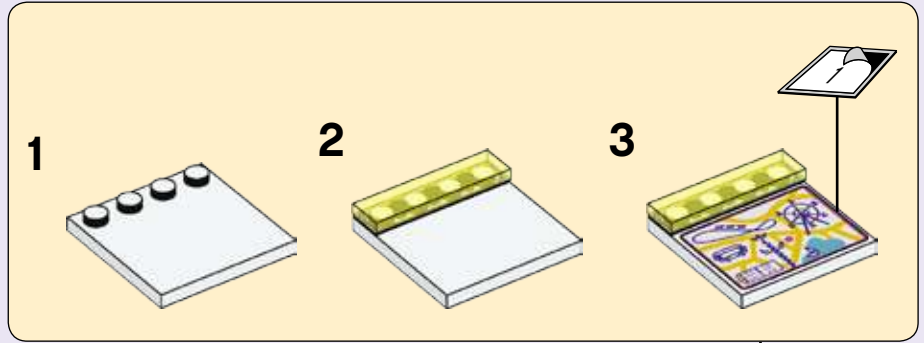



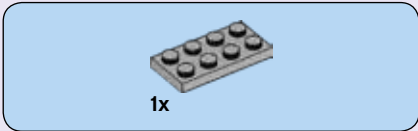
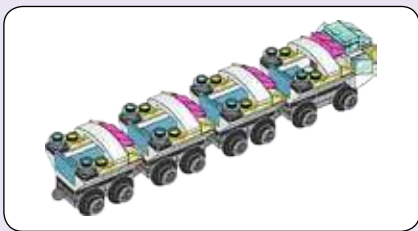

1

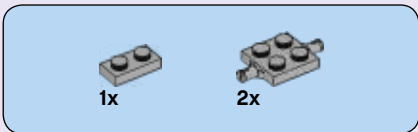
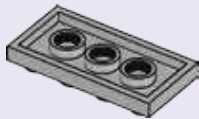

2

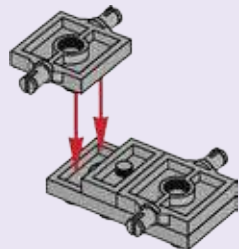

3

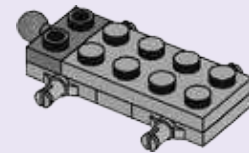
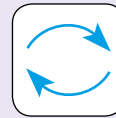

4

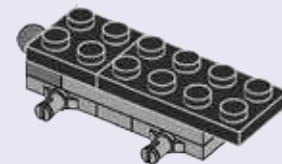

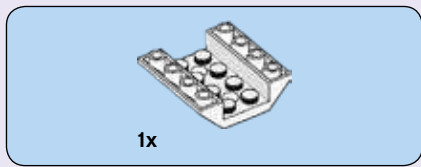

5

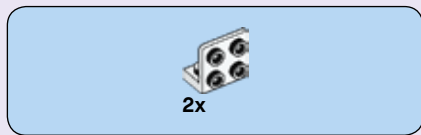
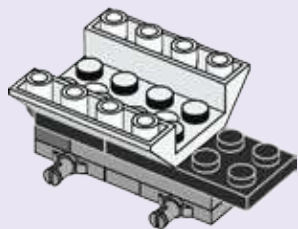

6

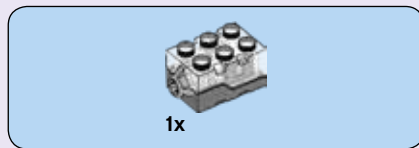
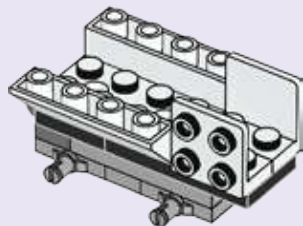

7

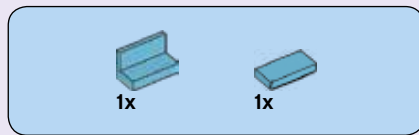
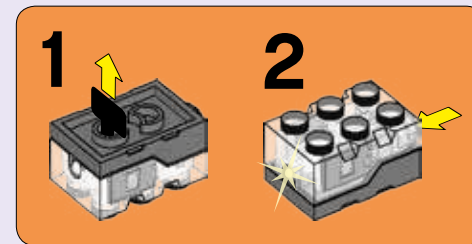
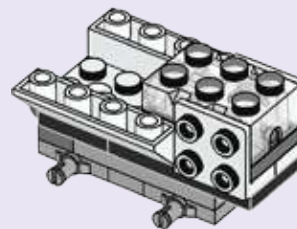

8

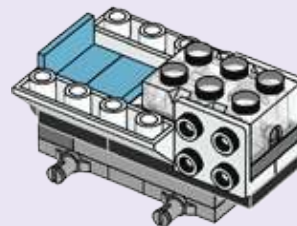

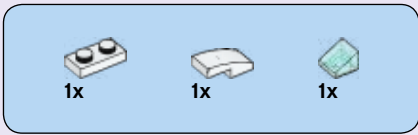

9

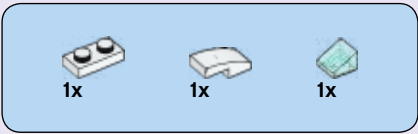
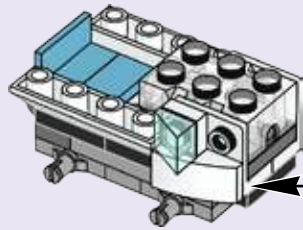
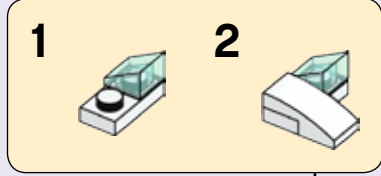

10

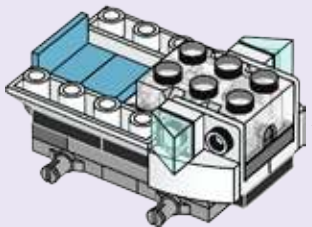
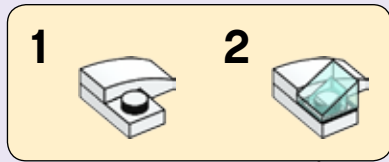

11



12



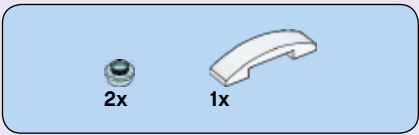

# 13

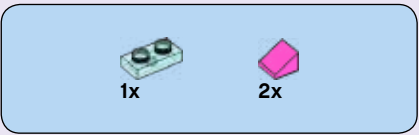
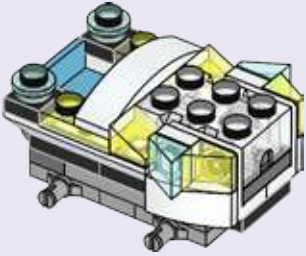

# 14

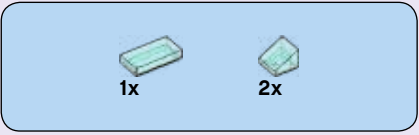
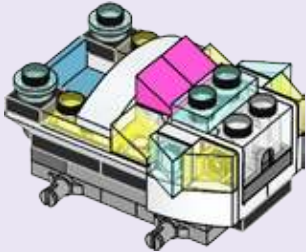

# 15

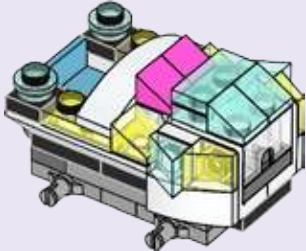

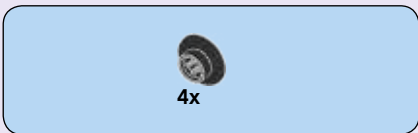

16

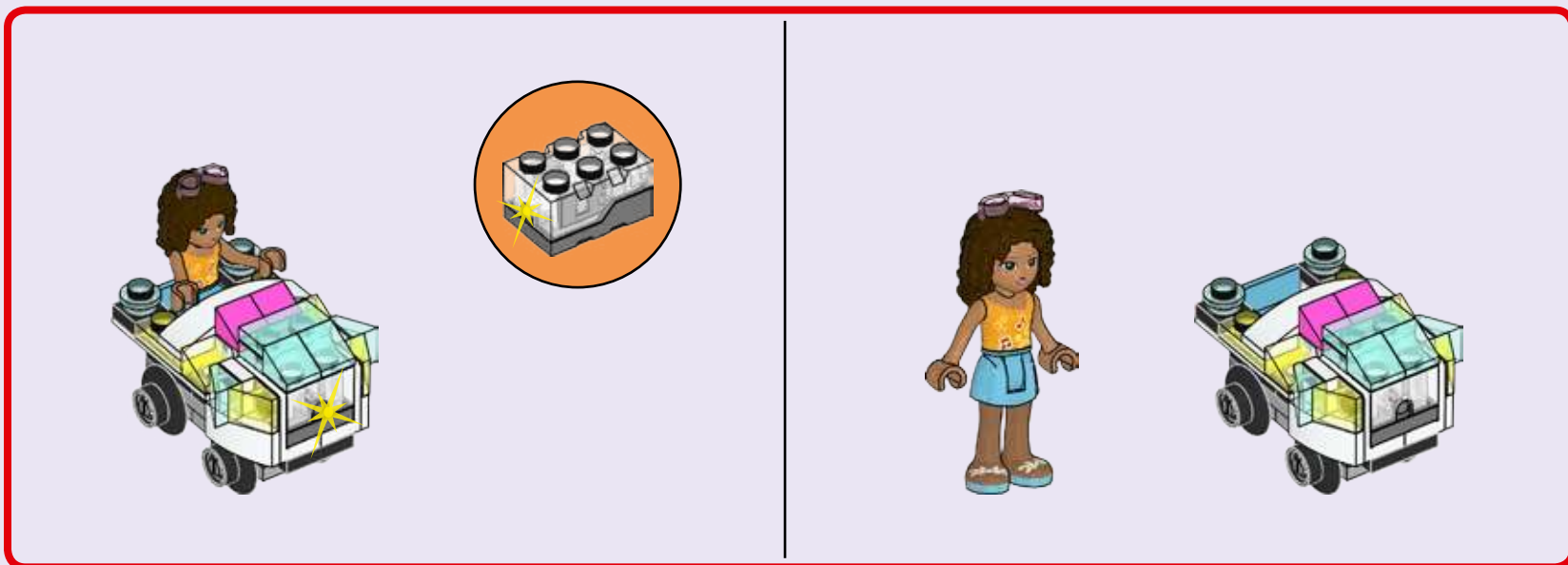
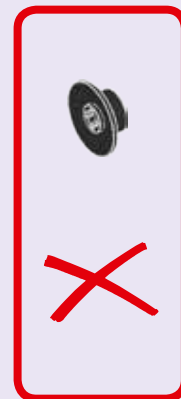
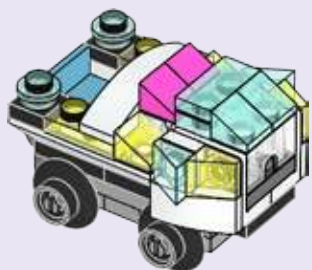



3x

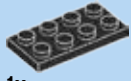

1x

# 17

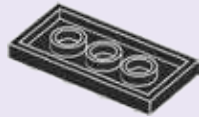

1x



1x



1x

# 18

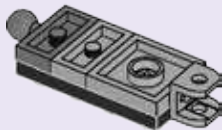

2x

# 19

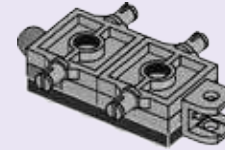

1x

# 20

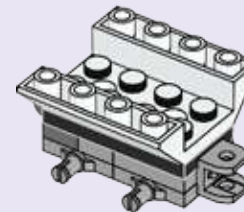
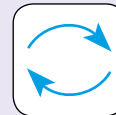

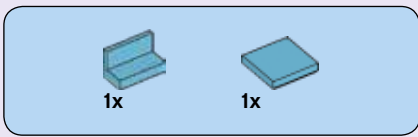

# 21

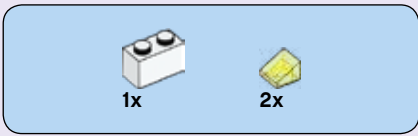
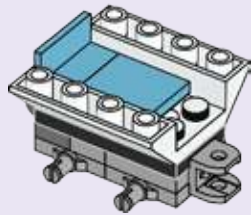

# 22

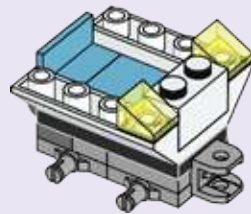

# 23

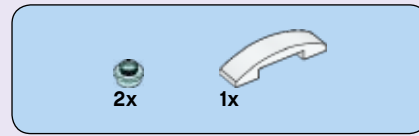
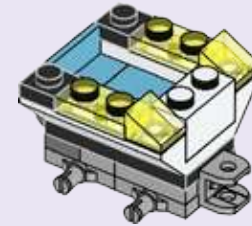

# 24

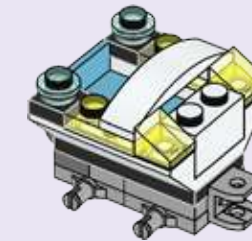



2x

25

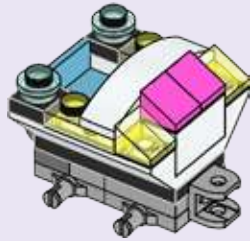

4x

26

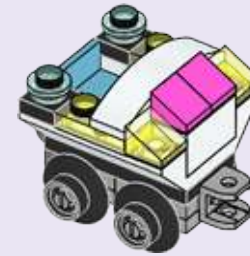

3x



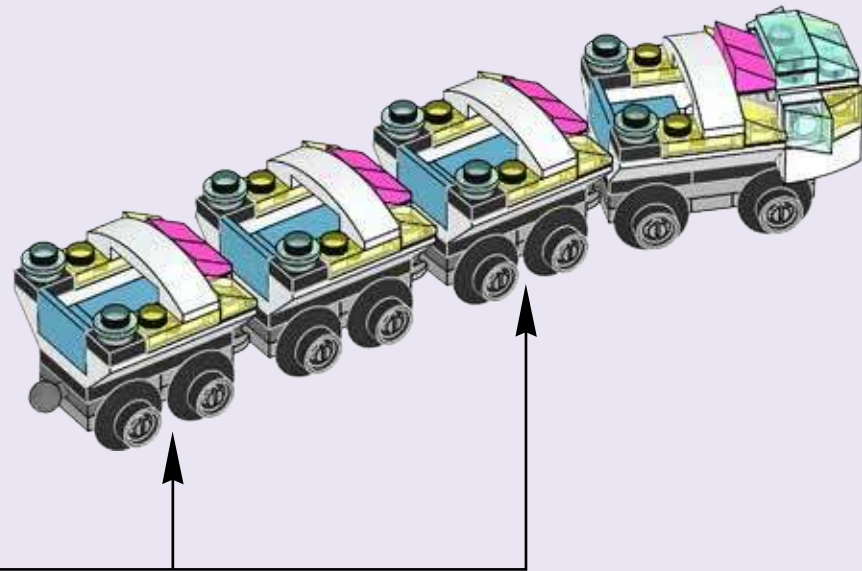



+

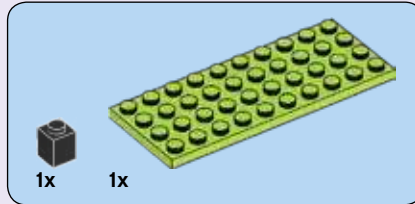
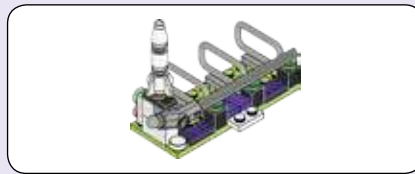

1

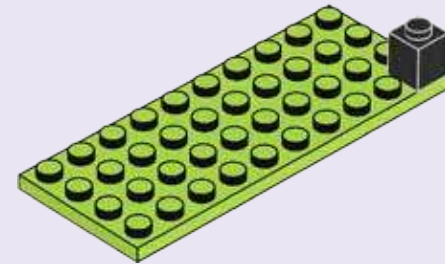



2

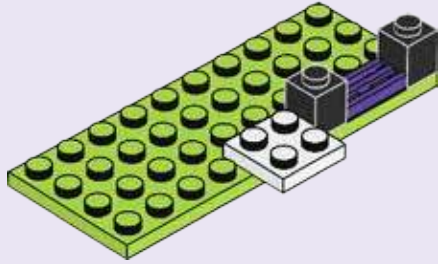

3

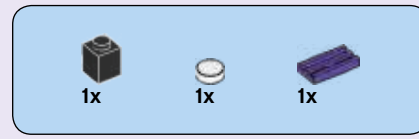

4

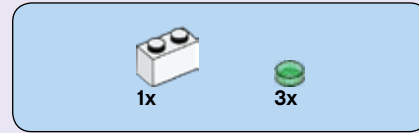
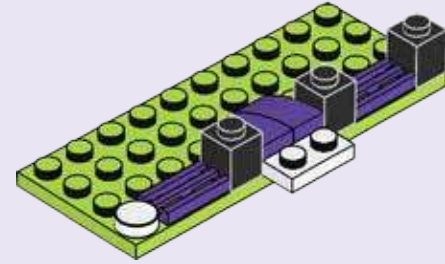

5

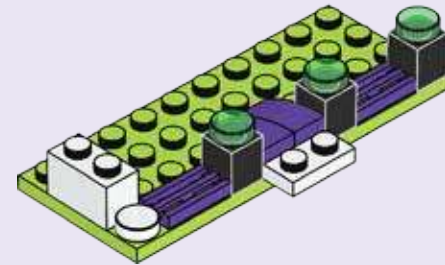

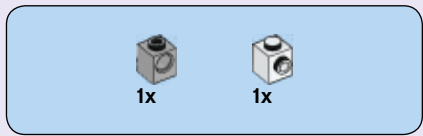

6

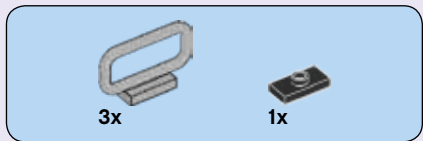
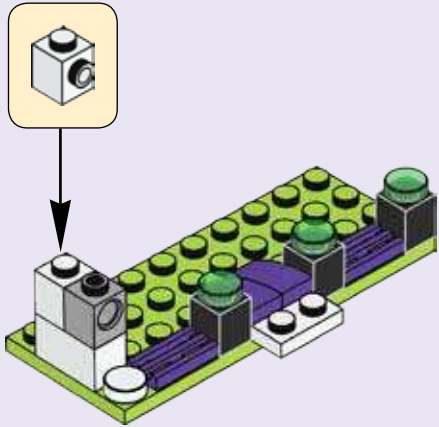

7

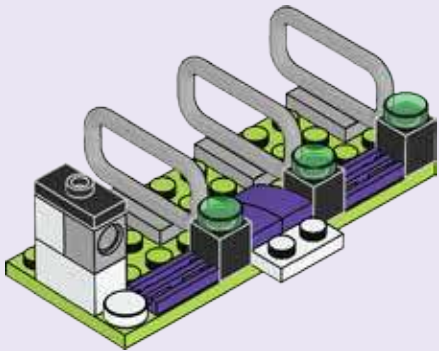

8

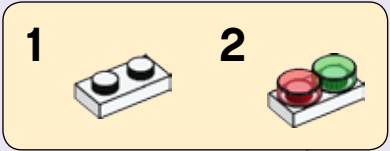
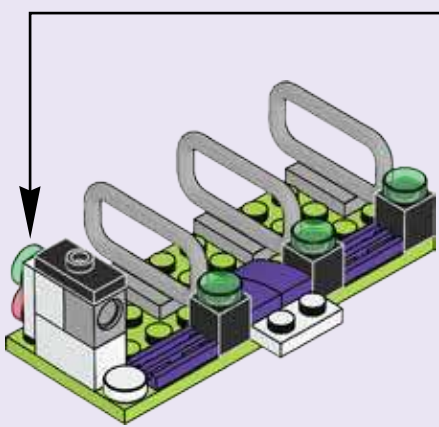

9

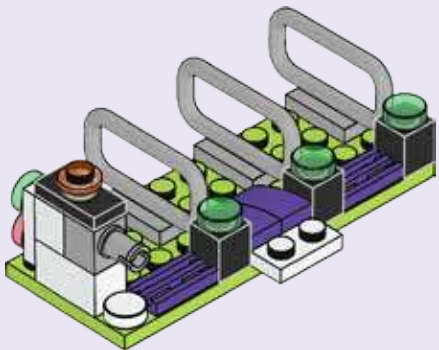

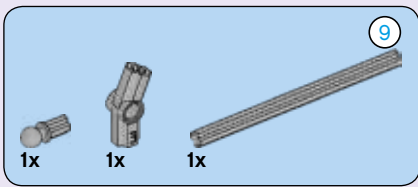

# 10

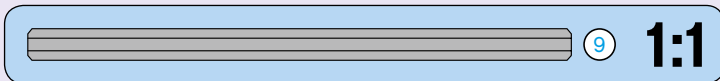
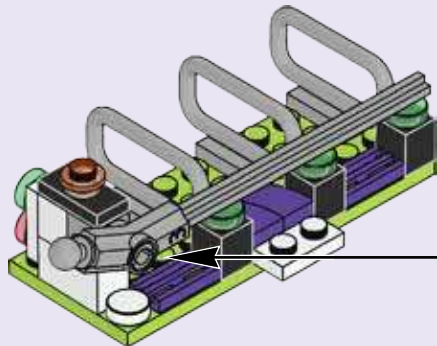
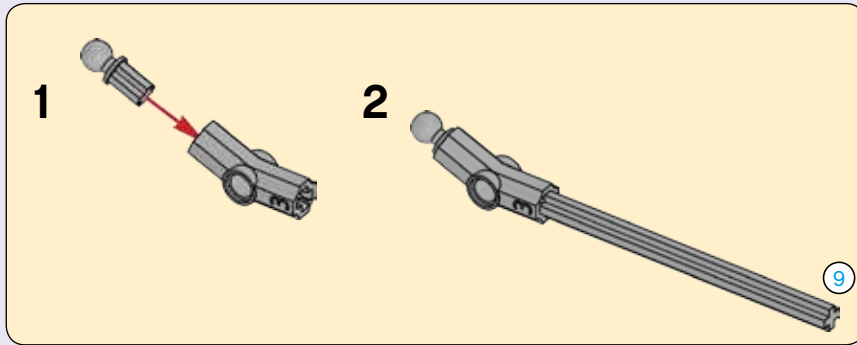

# 11

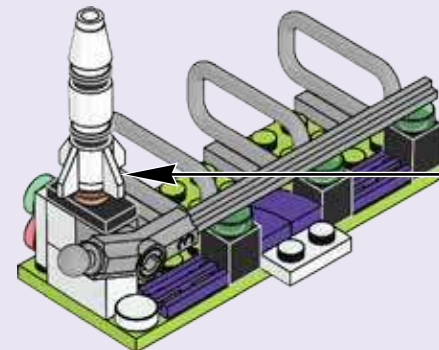
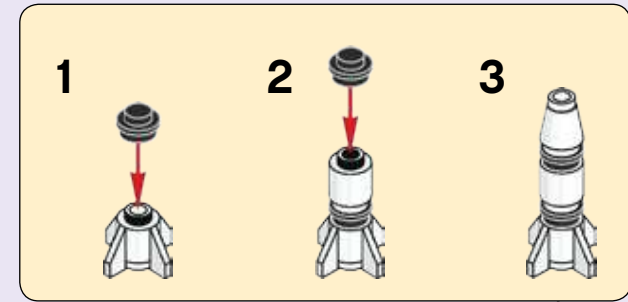

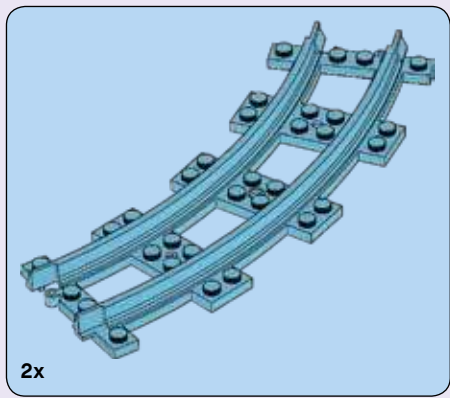

12

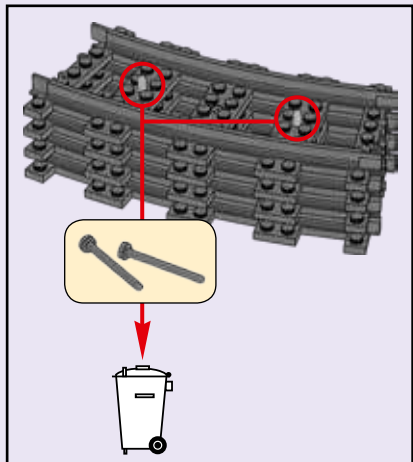
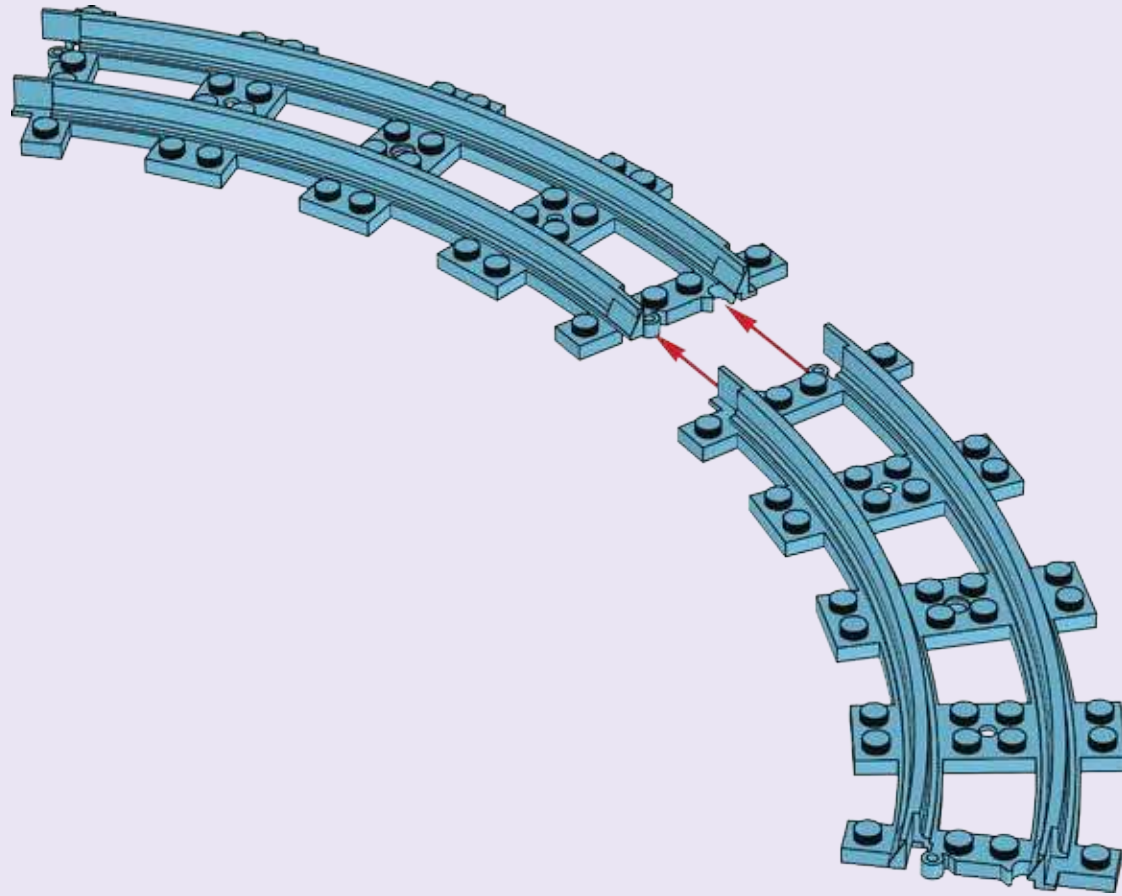

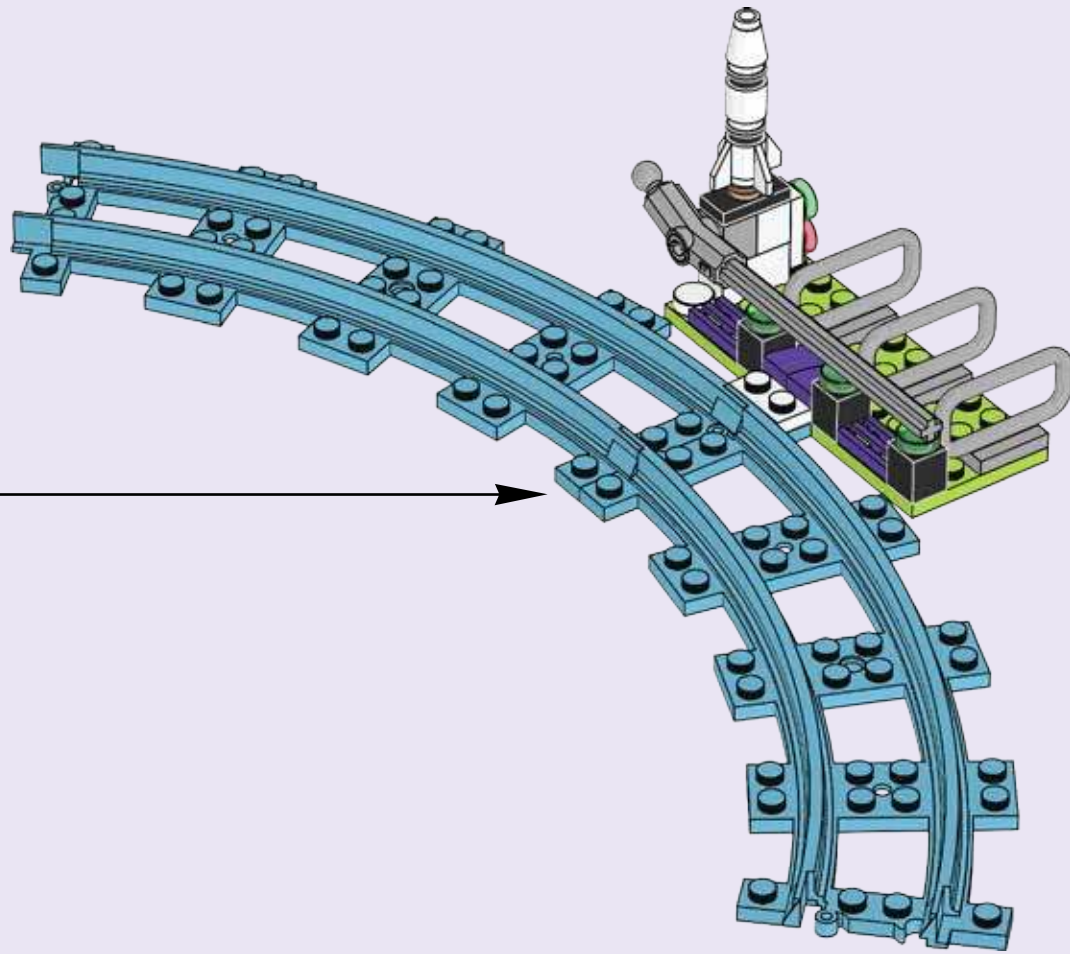

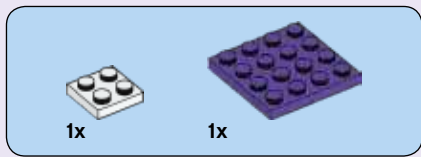

13



14

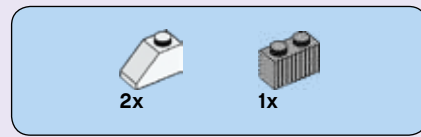

15

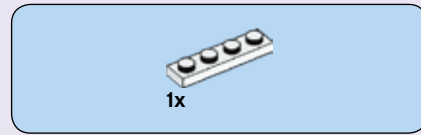

16





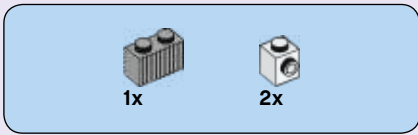

# 17

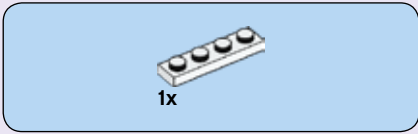
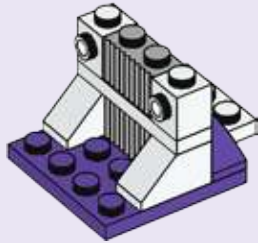

# 18



# 19

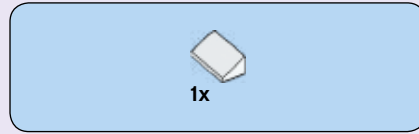

# 20

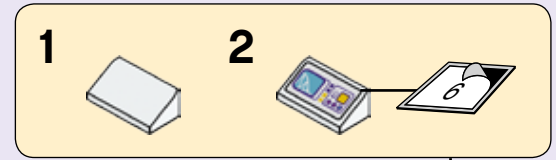

21

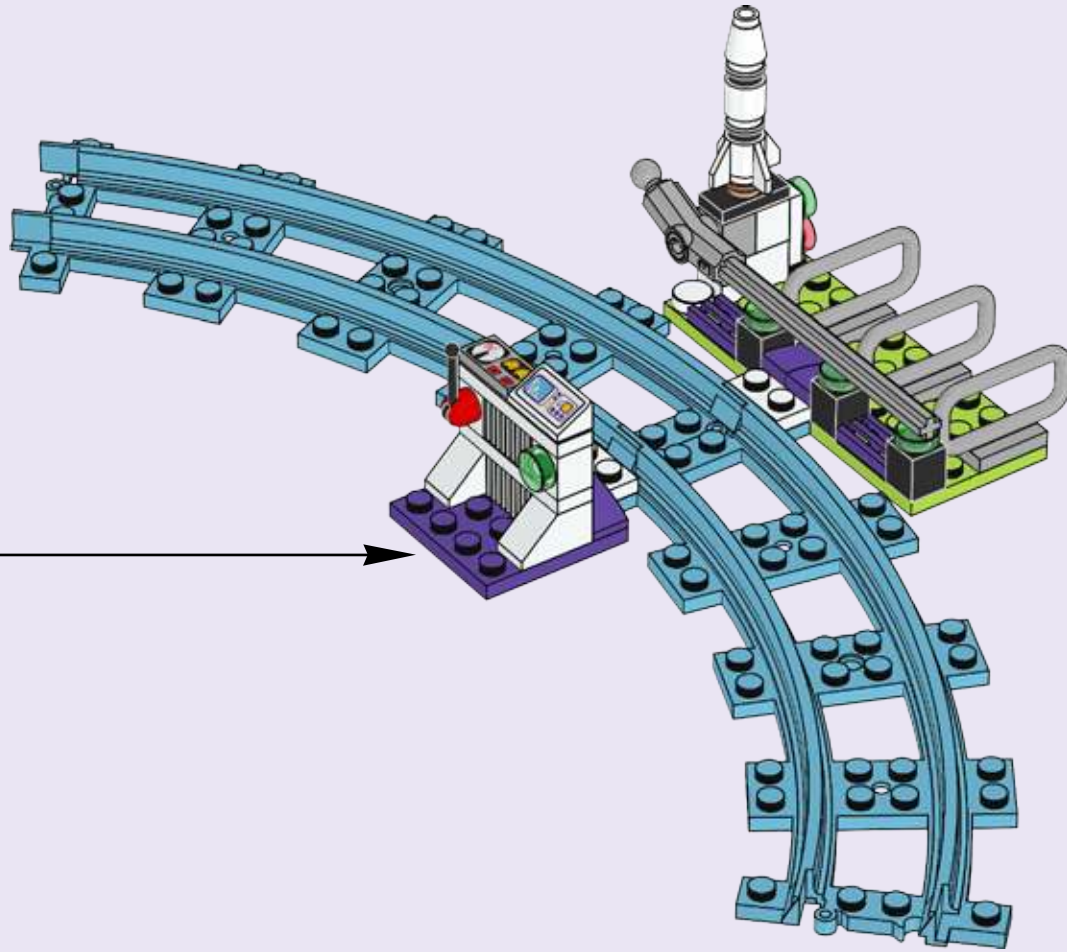

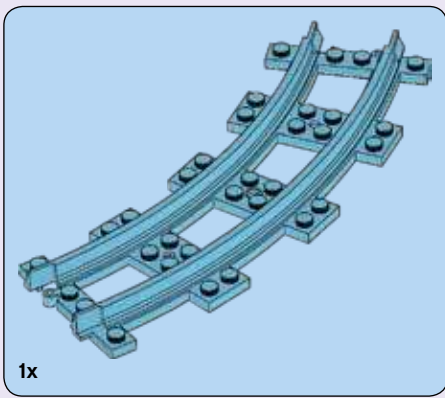

22

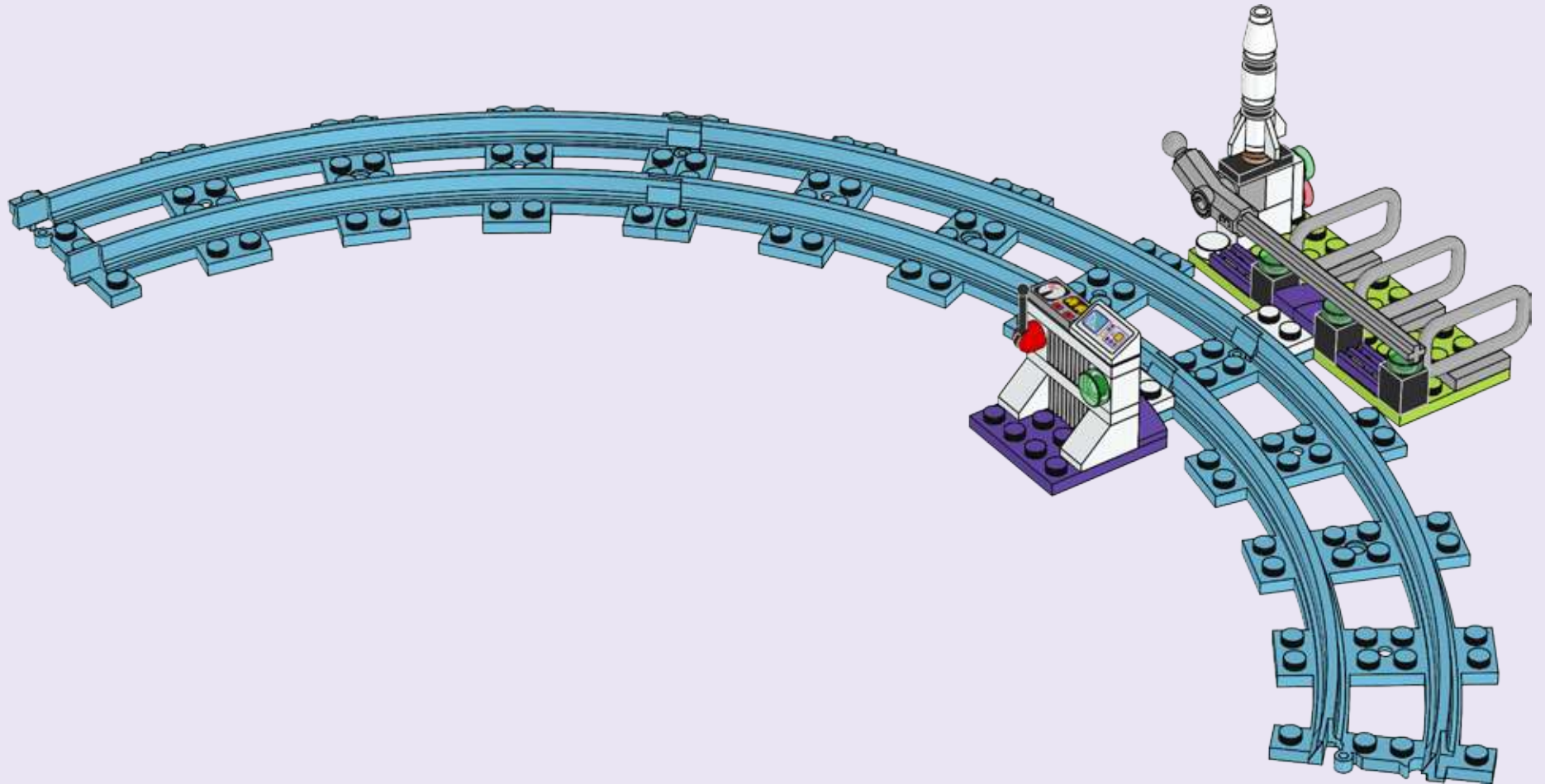

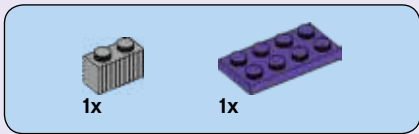
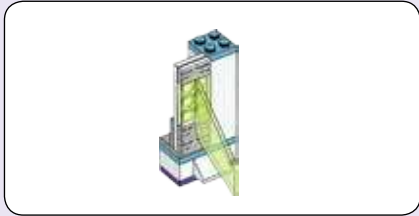
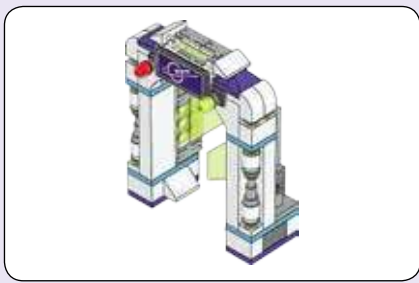

23

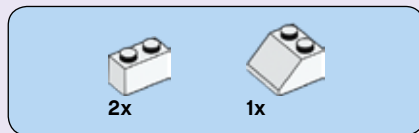
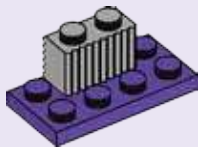

24

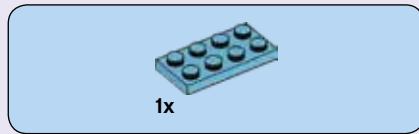
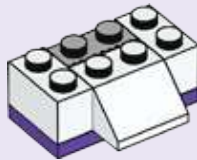

25



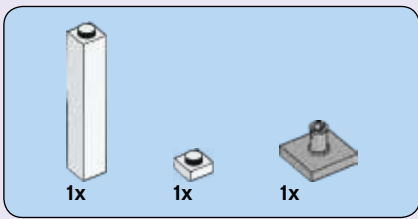

26

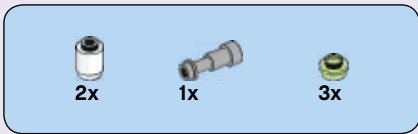
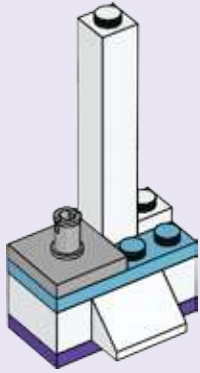

27

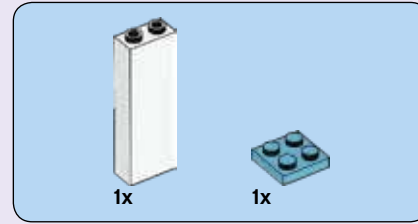
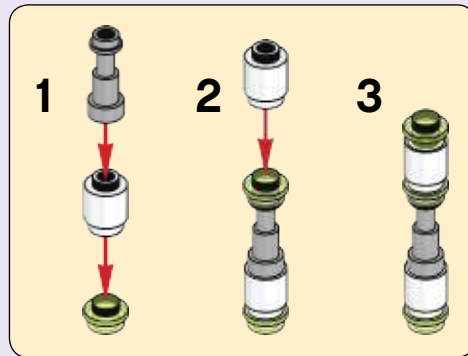
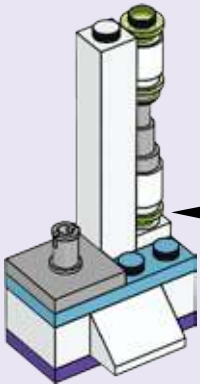

28

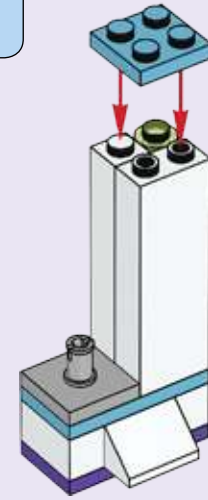

29

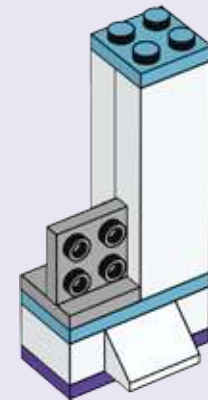

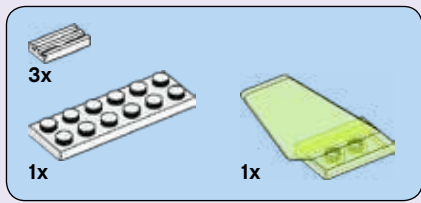

# 30

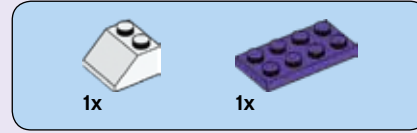
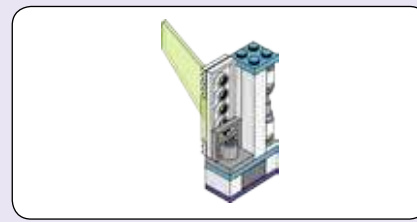
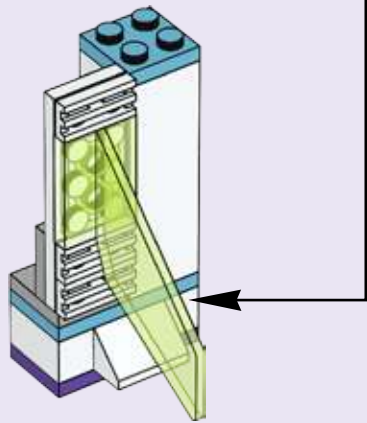
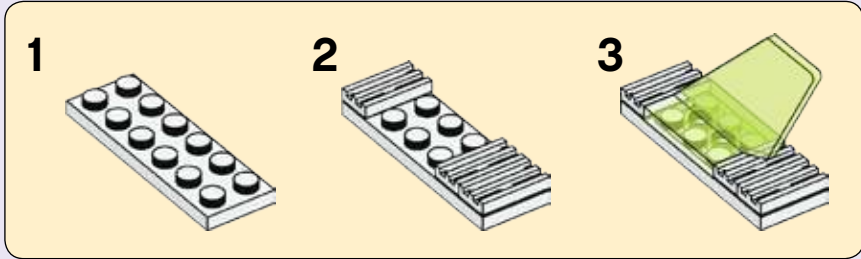

# 31

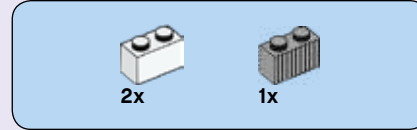

# 32



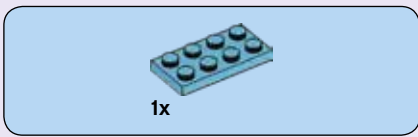

33

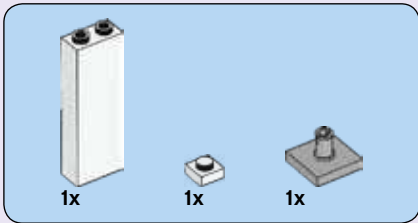
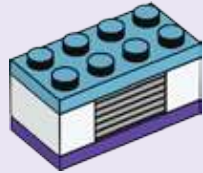

34

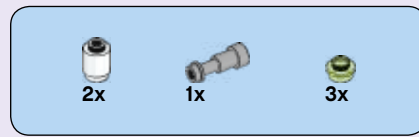
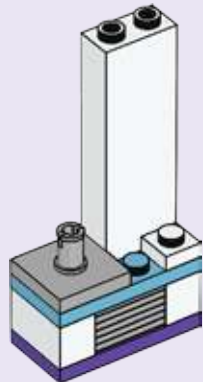

35

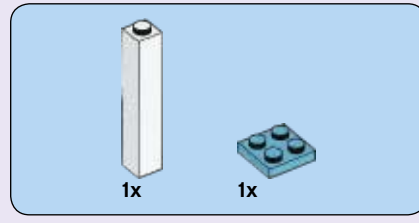
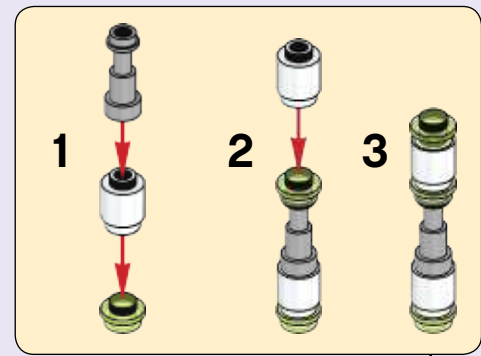
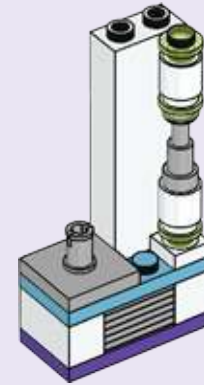

36

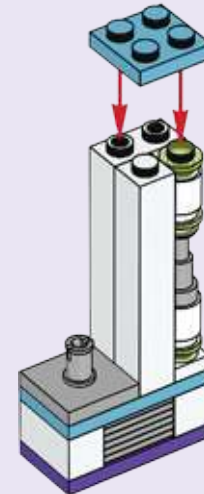

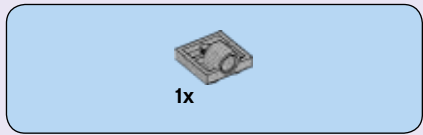

37

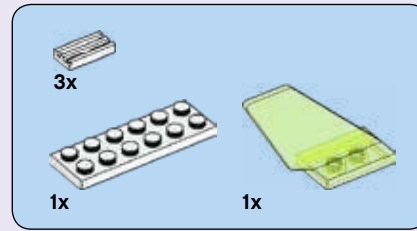
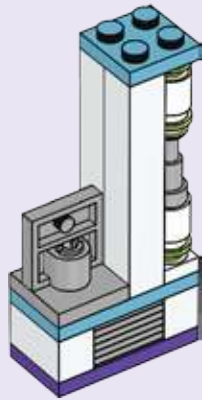

38

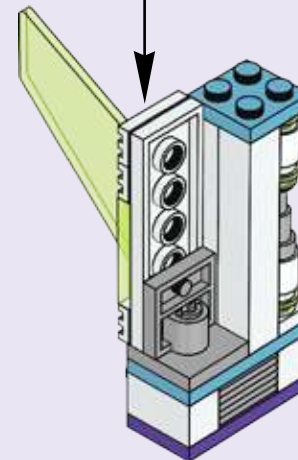
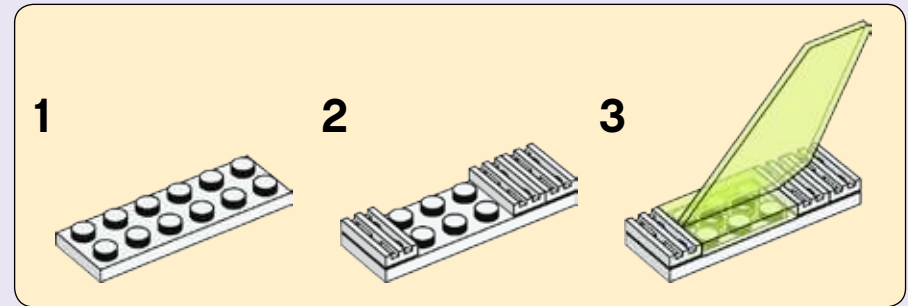



# 39

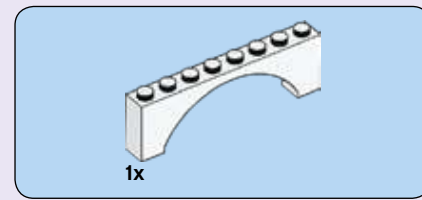
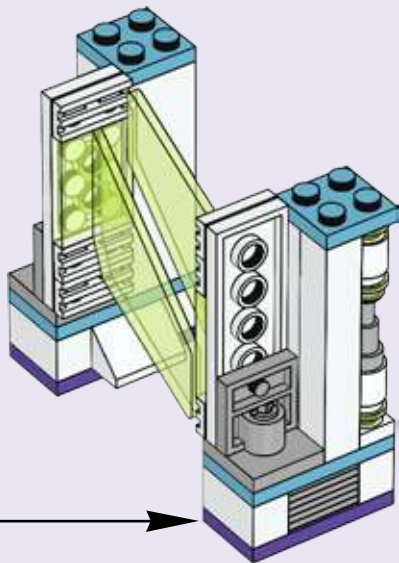

# 40

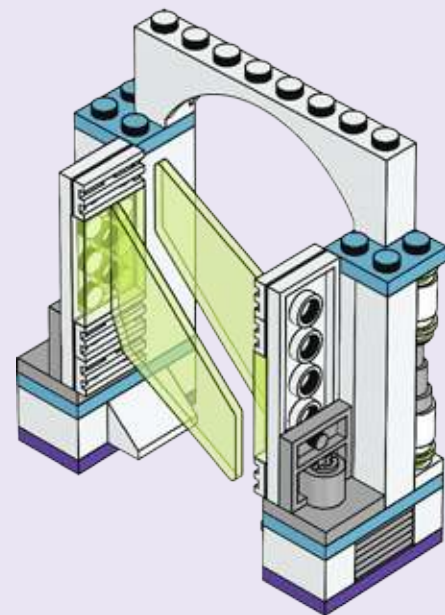



2x

# 41

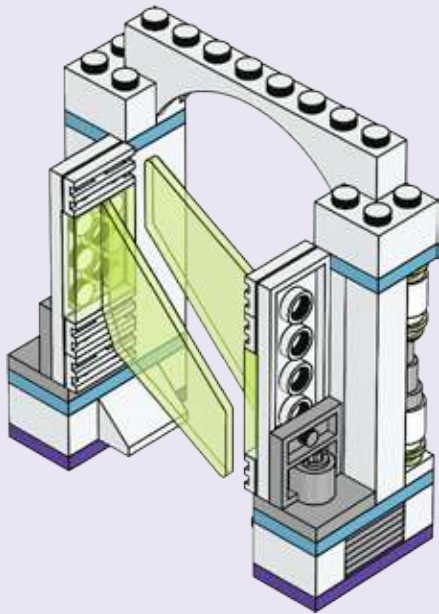

4x

# 42

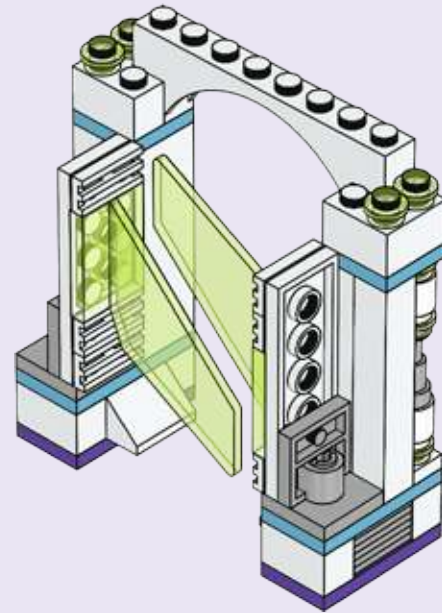



2x

# 43

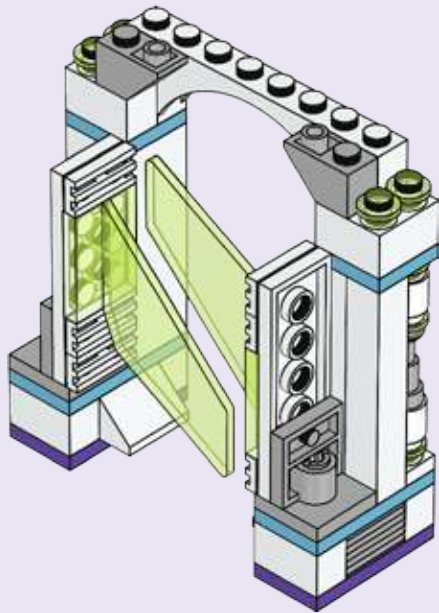

4x

# 44

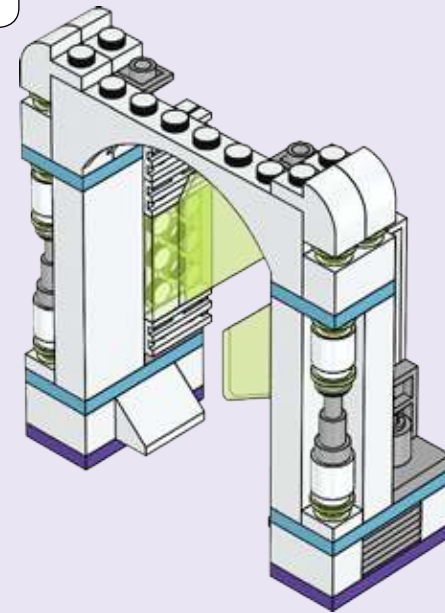
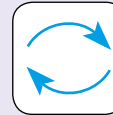

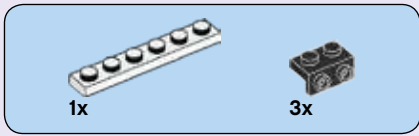

45

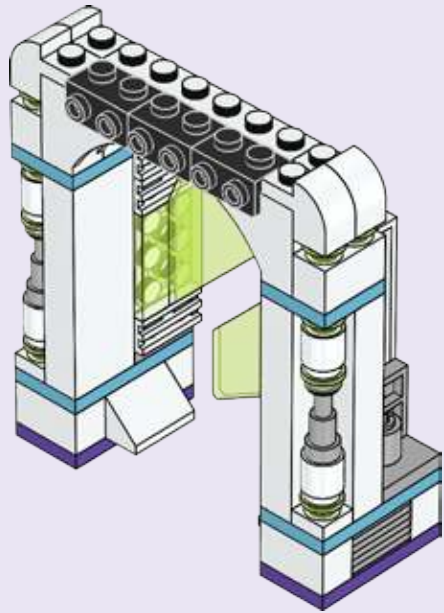

46

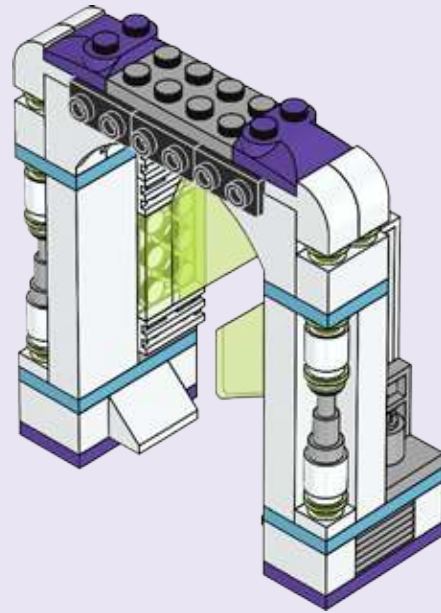

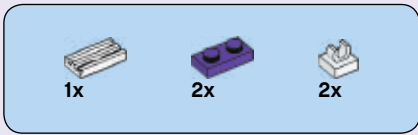

47

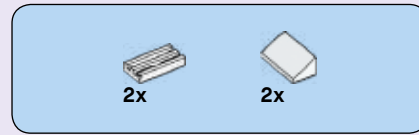
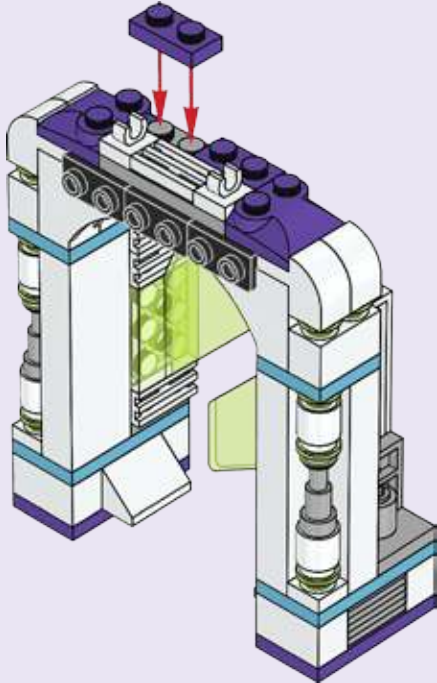

48

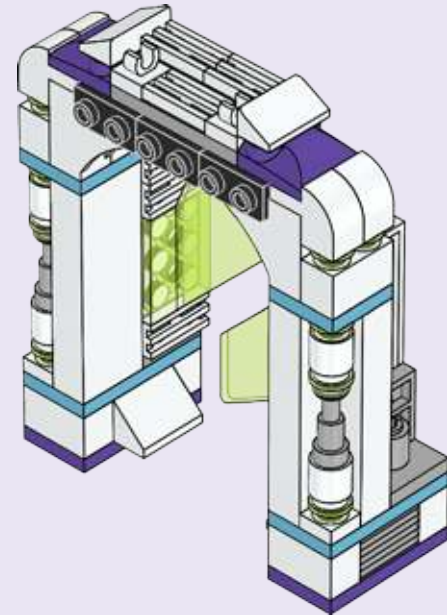

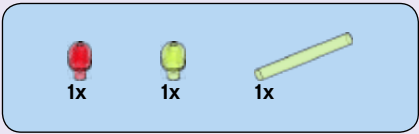

# 49

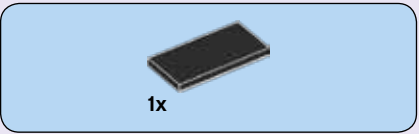
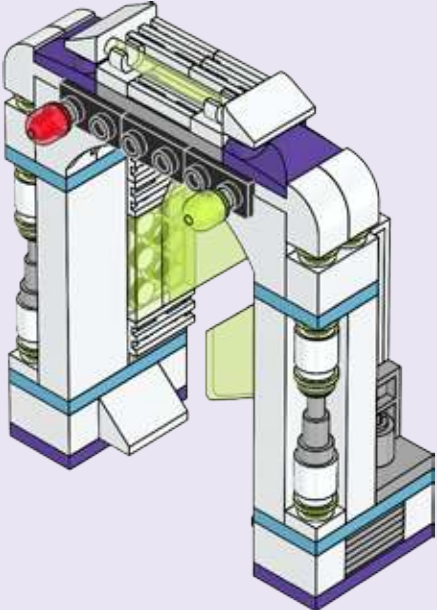

# 50

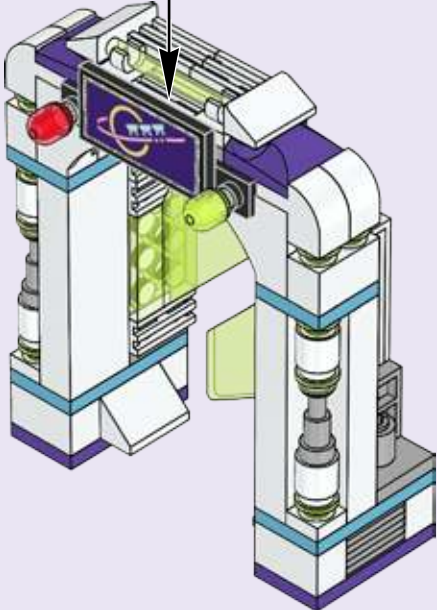

51

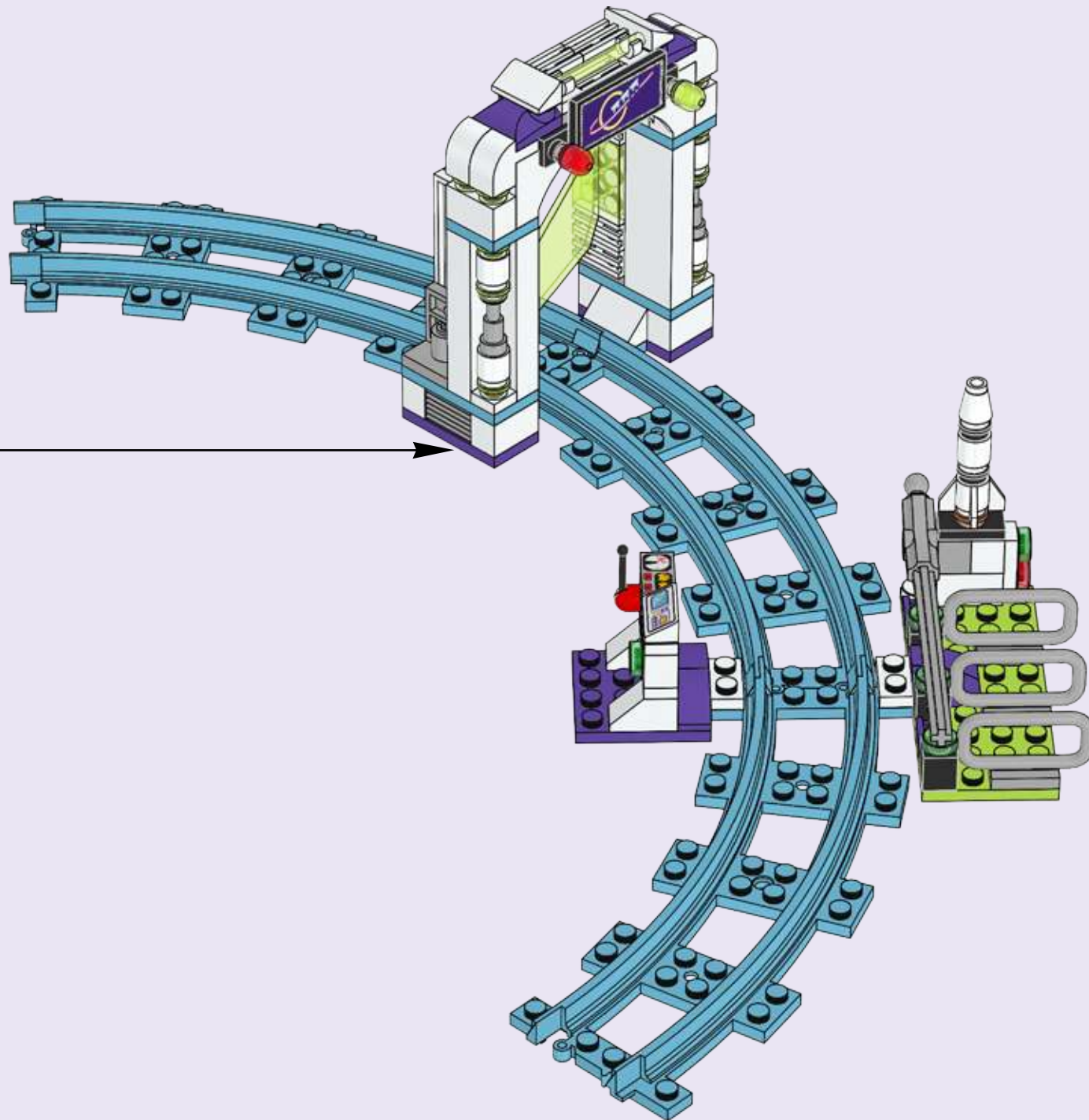

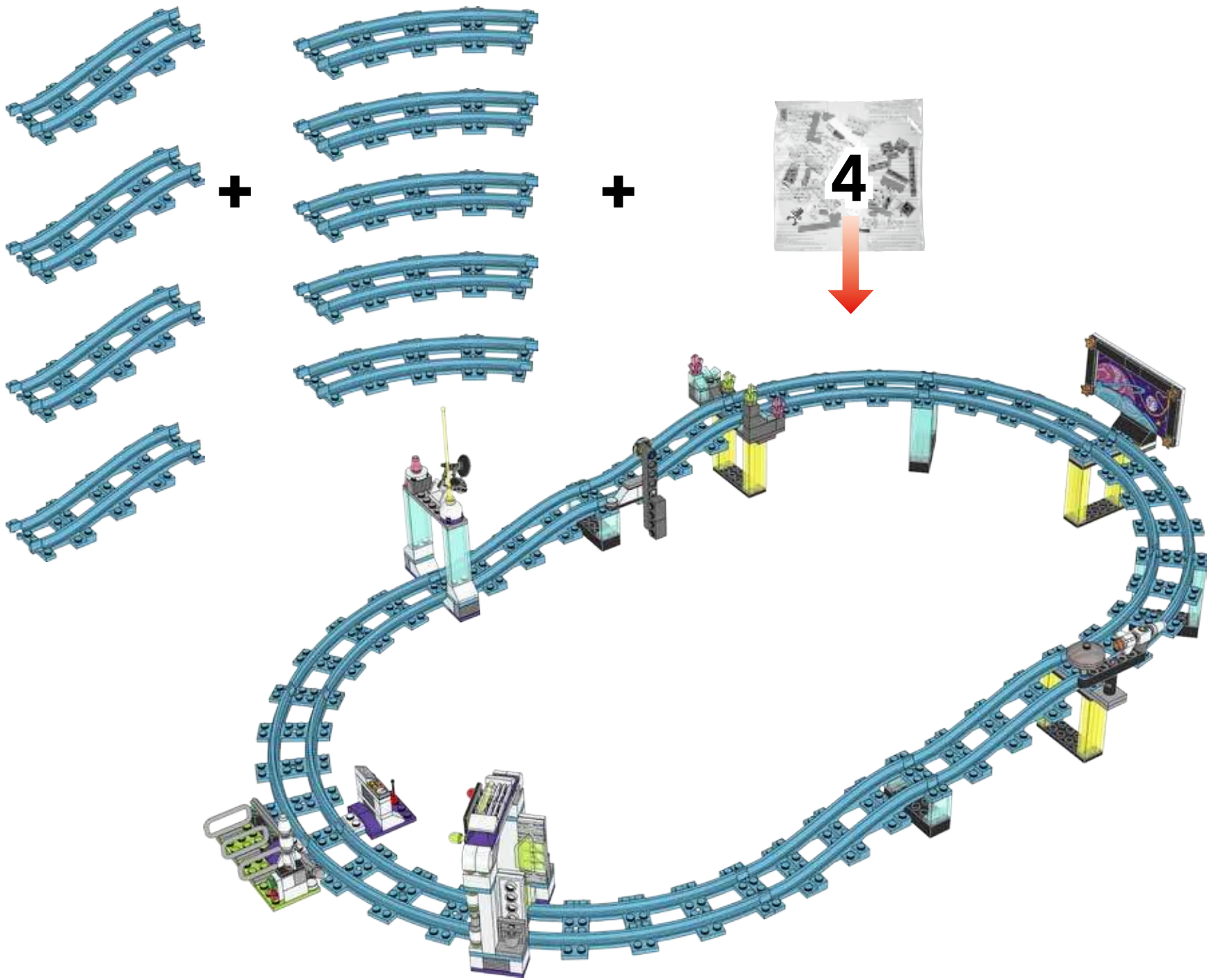



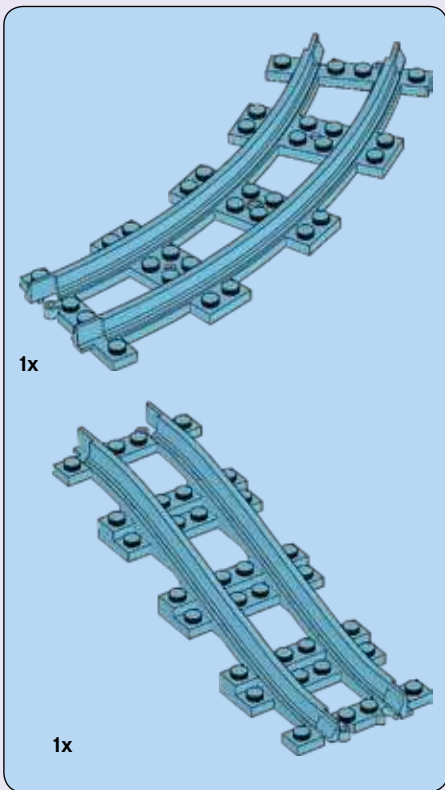

52

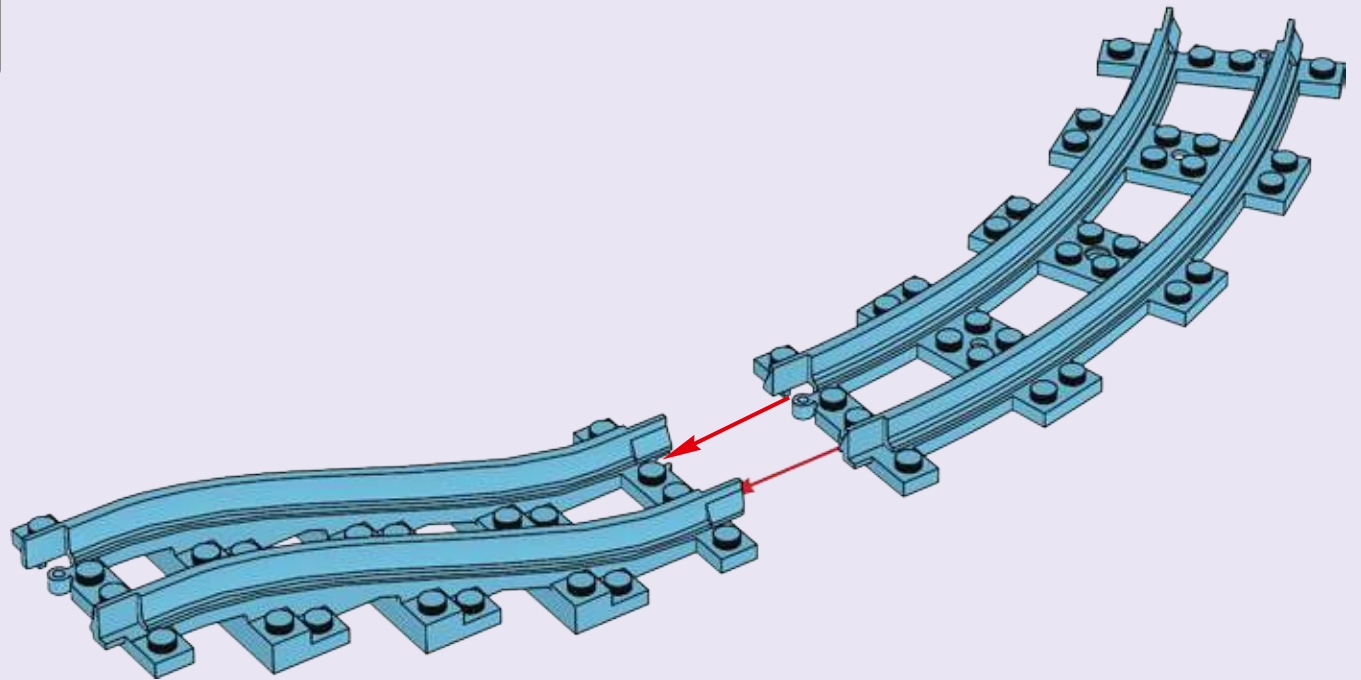

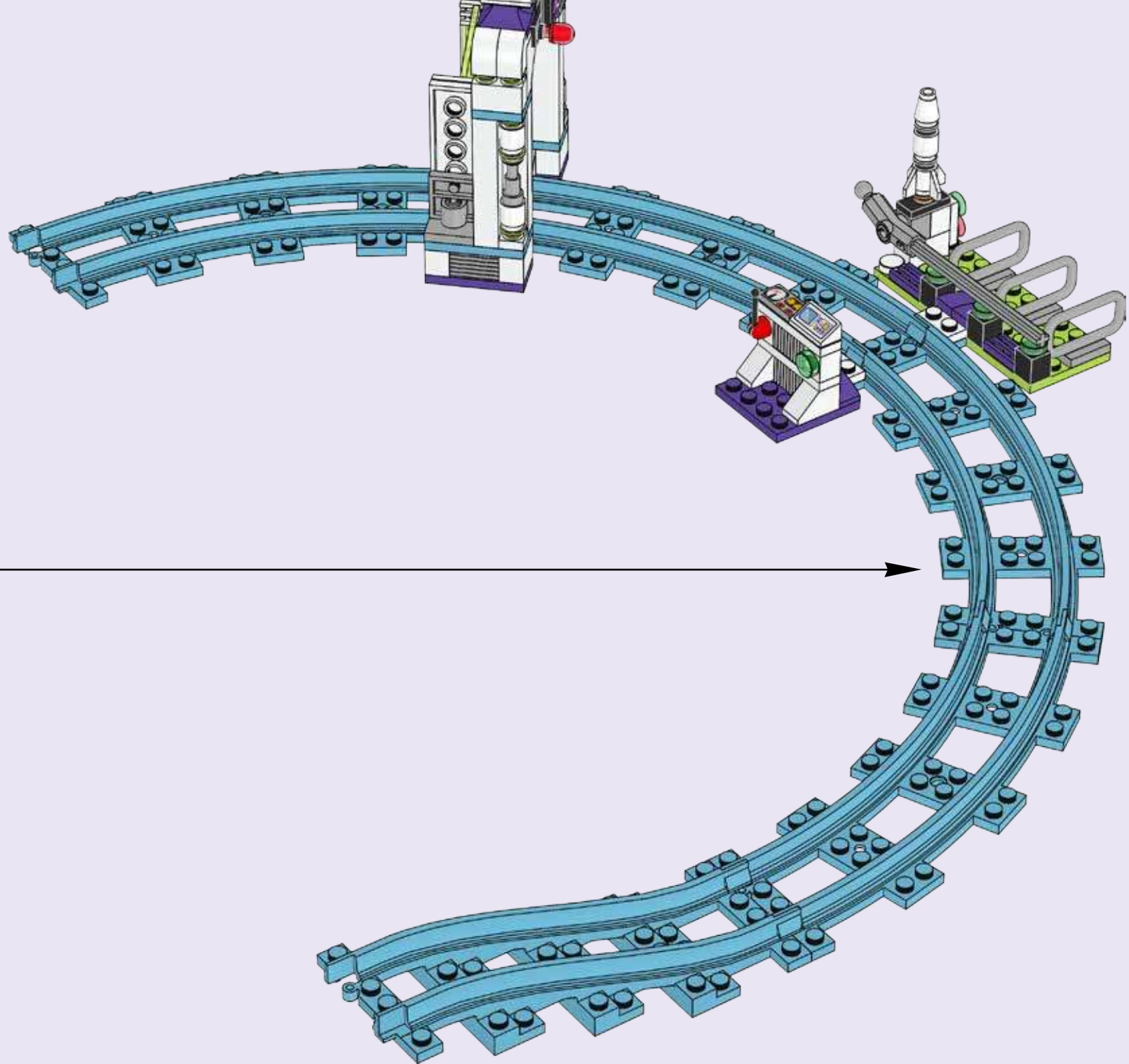

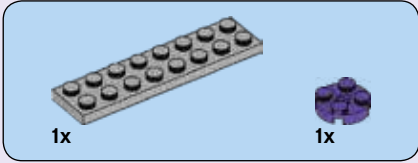

53

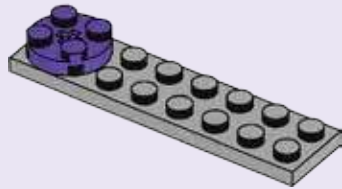

54

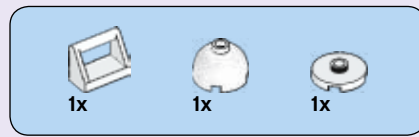
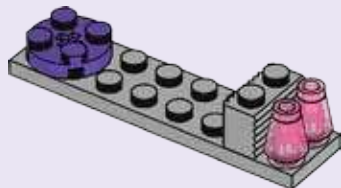

55

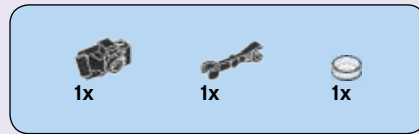
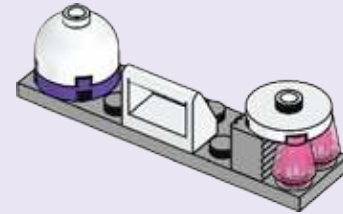

56

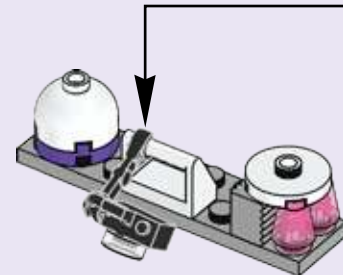
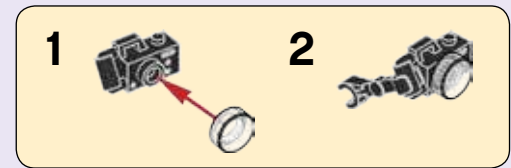

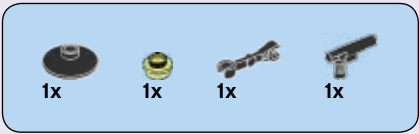

# 57

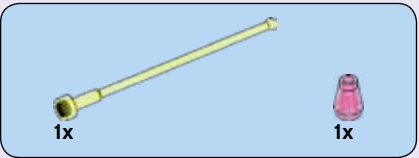
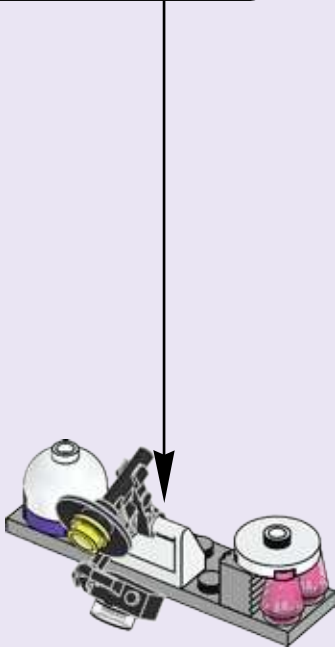
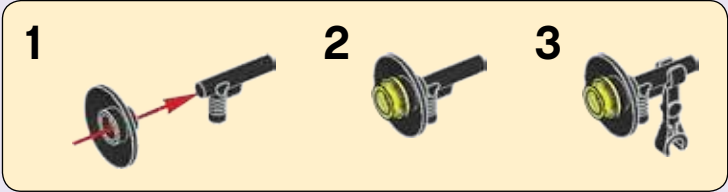

# 58



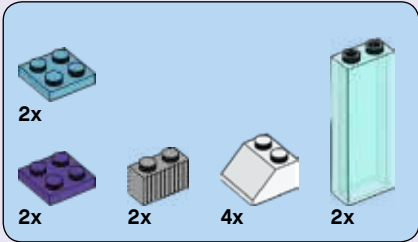

**59**

**1**



**2**



**3**



**4**



**5**

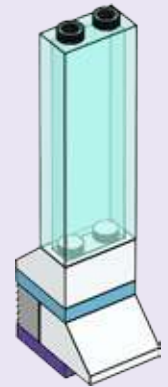

**2x**

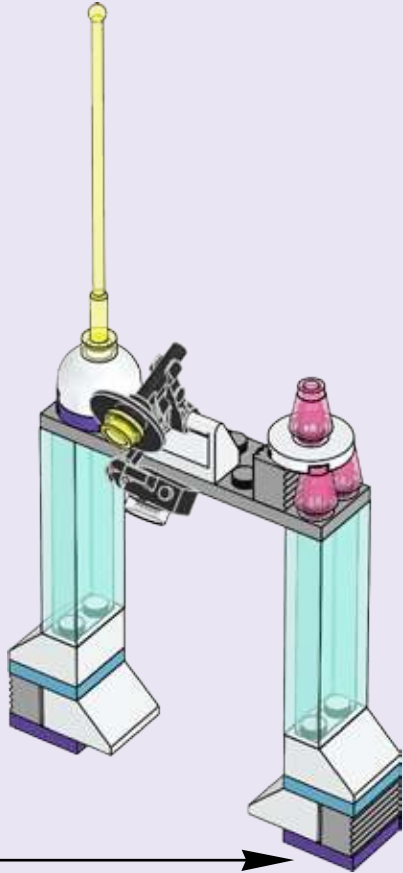

60

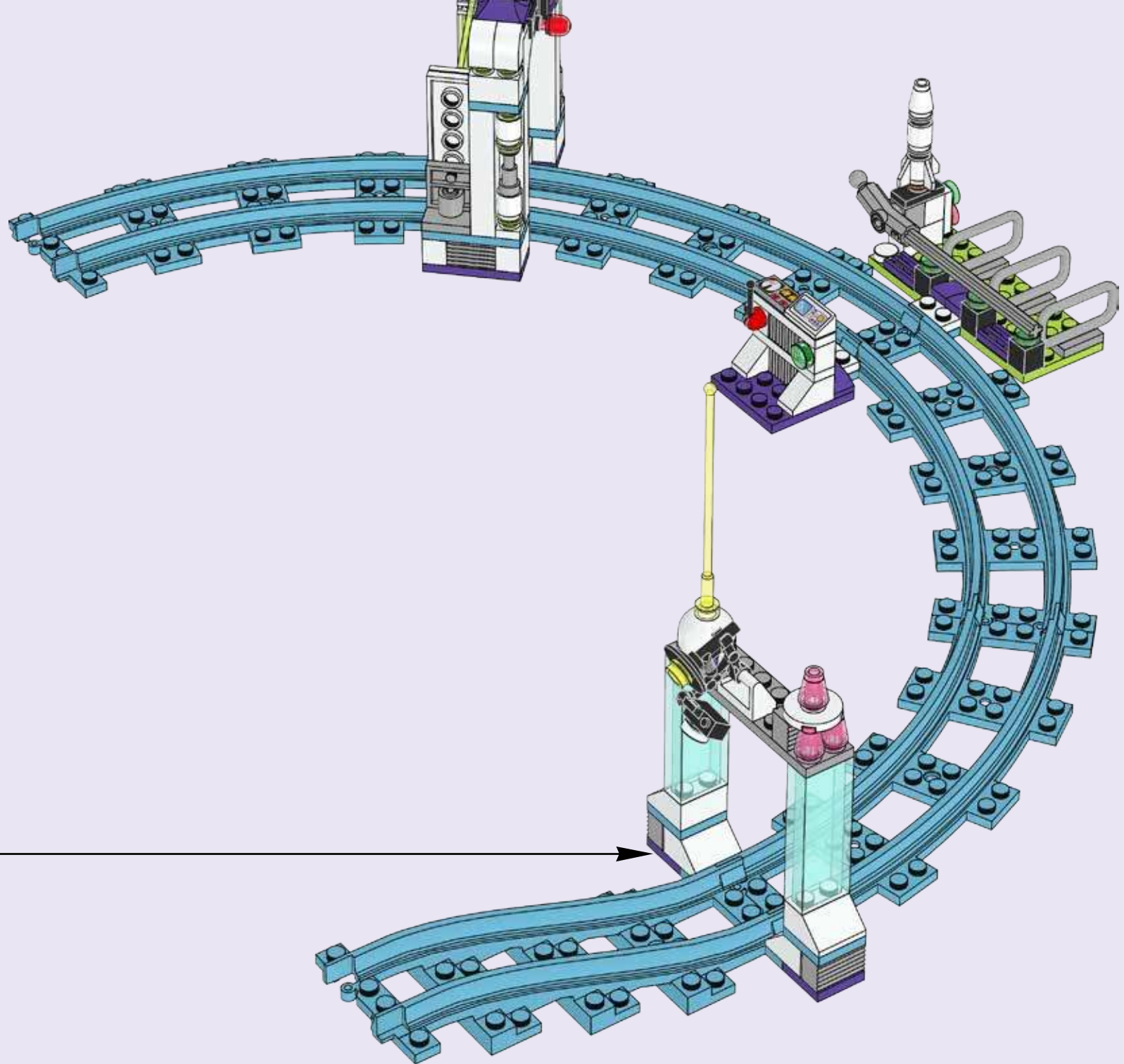

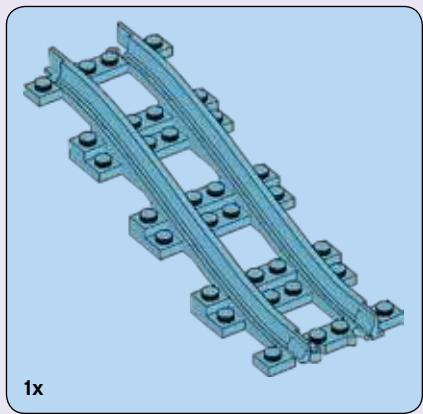

61

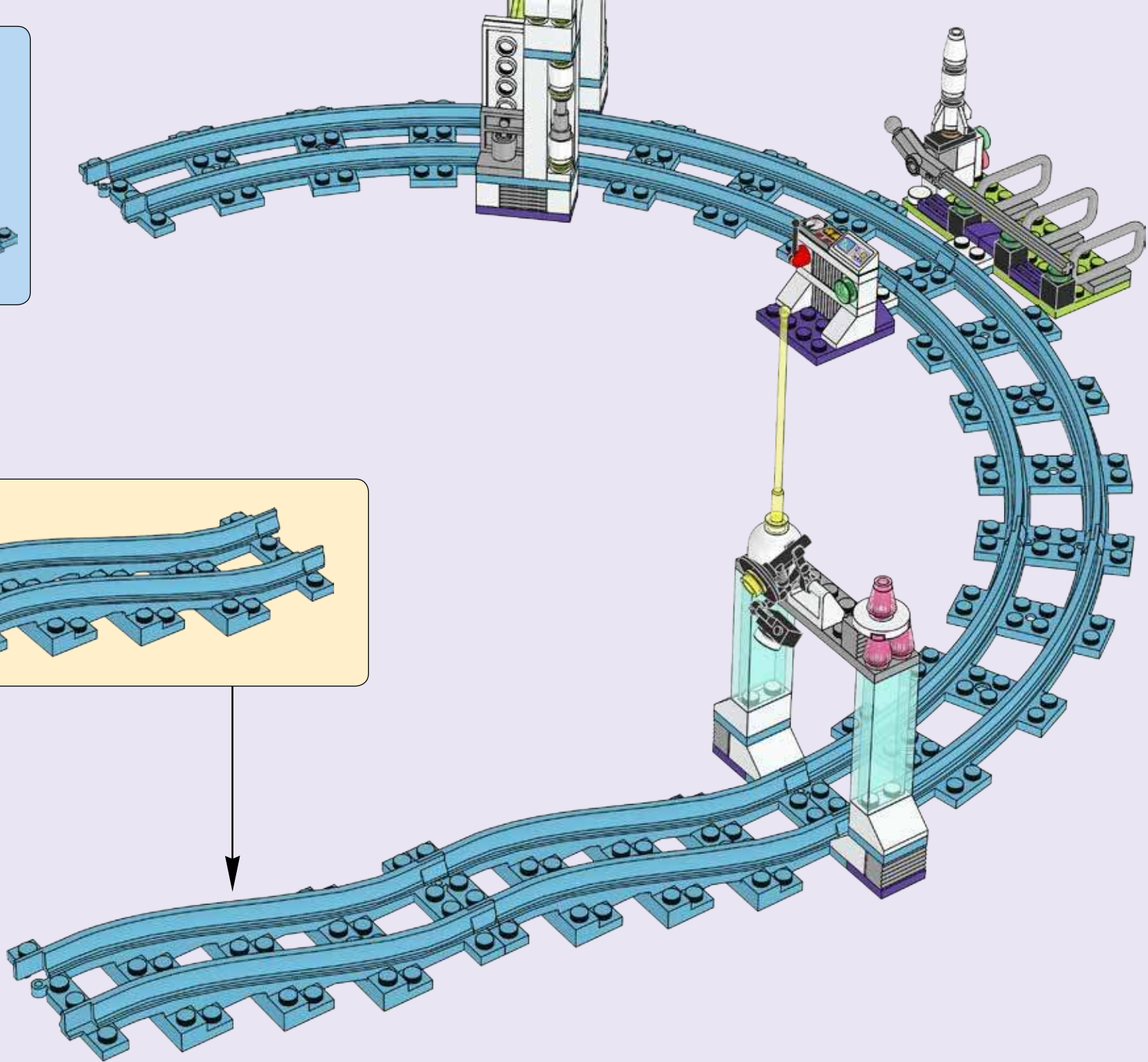
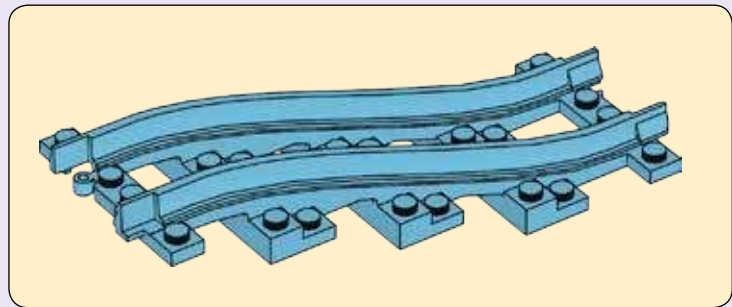



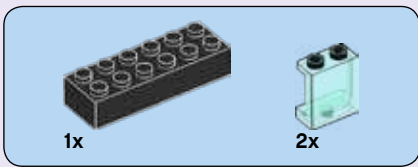

62

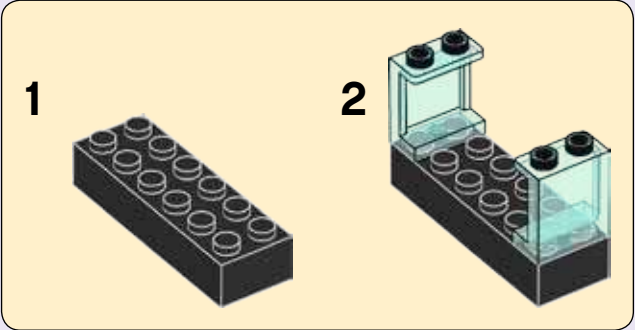
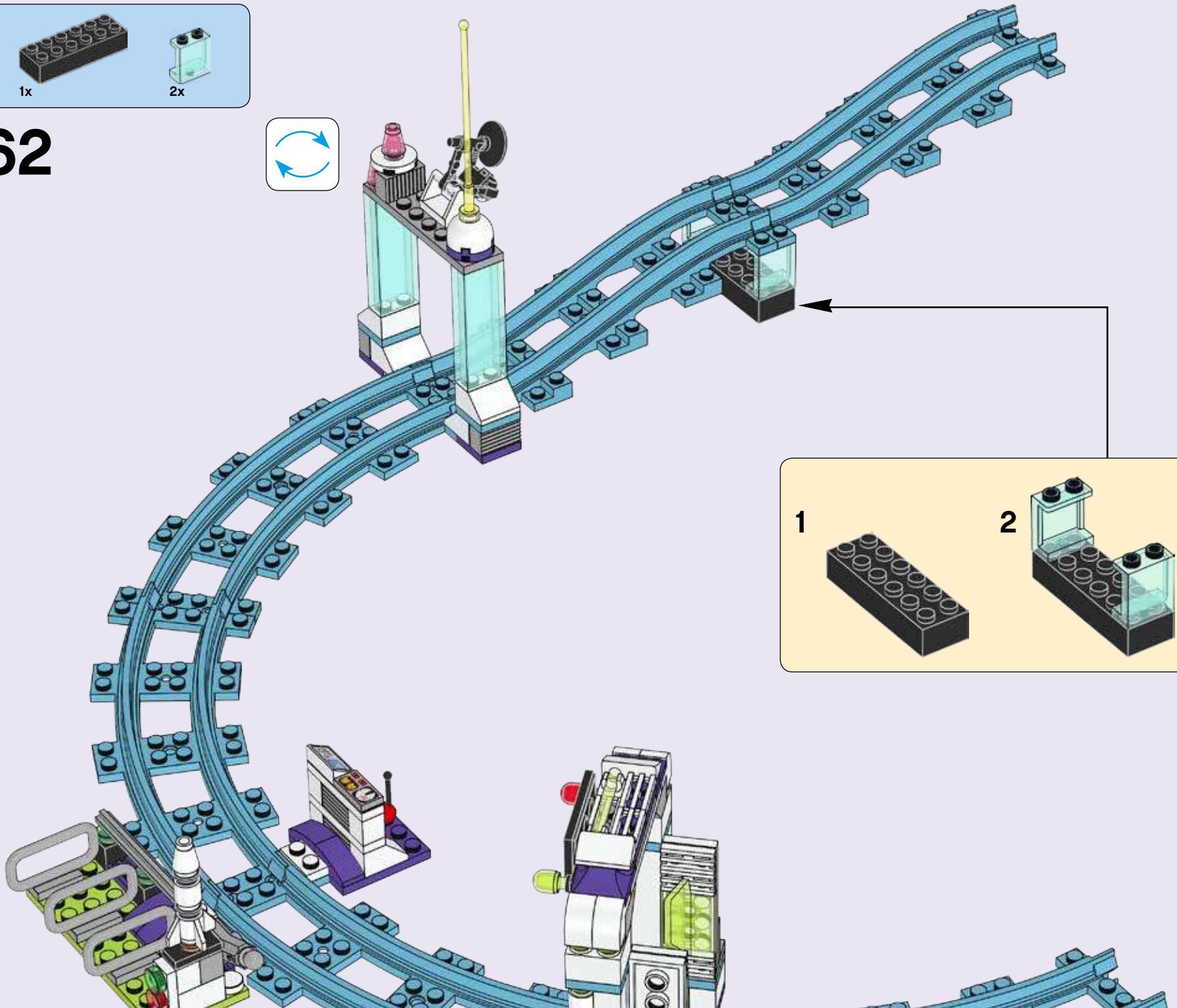
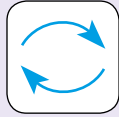

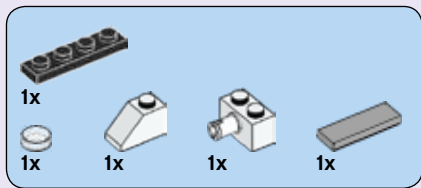

63

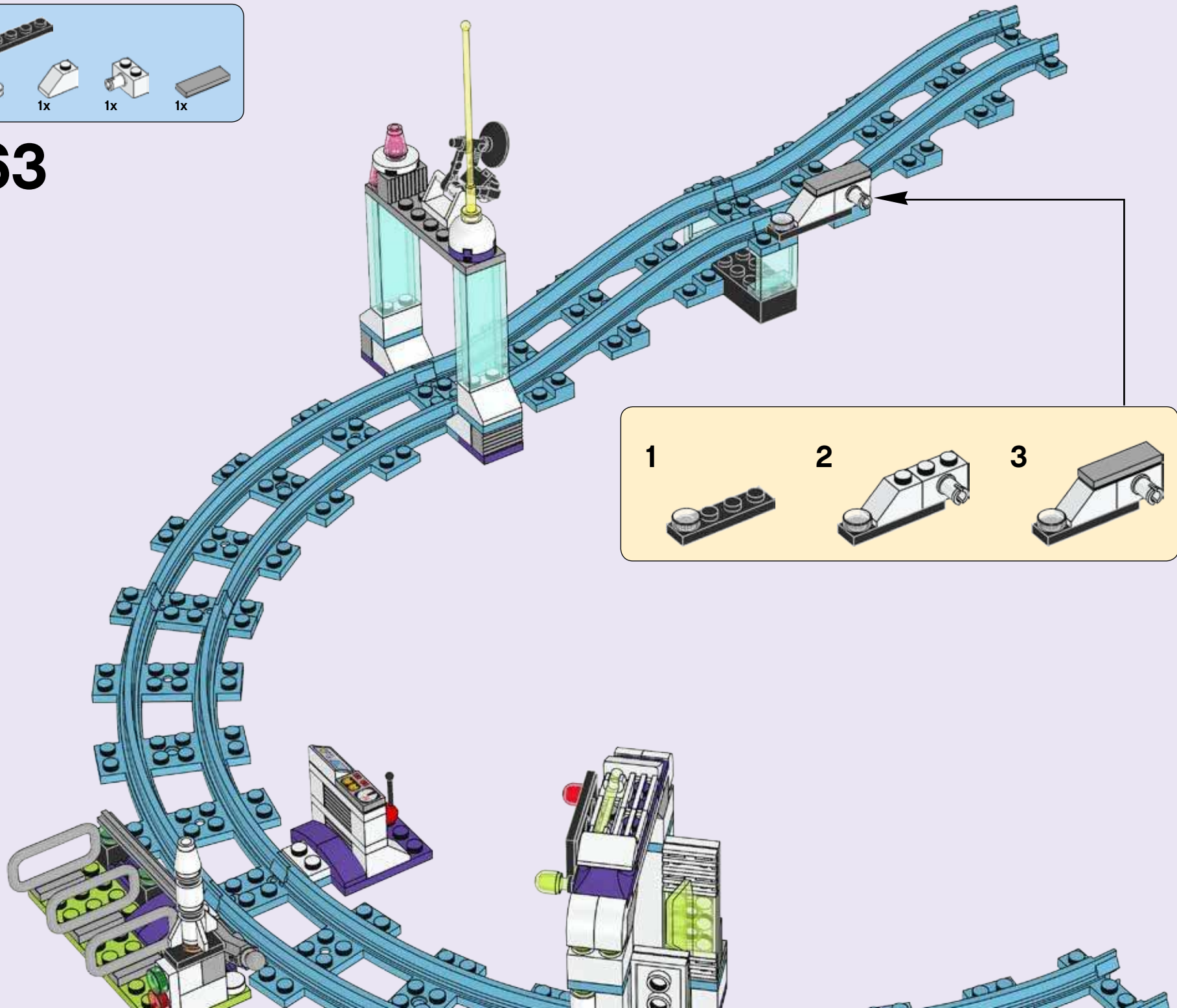

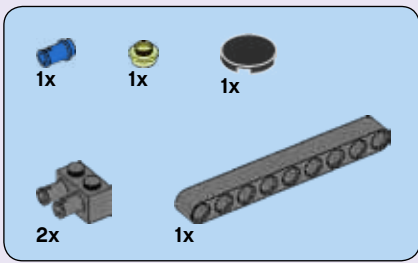

# 64

1

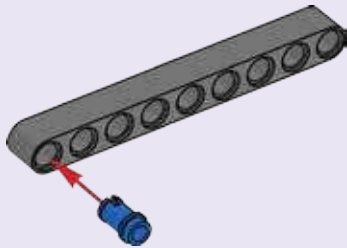

2

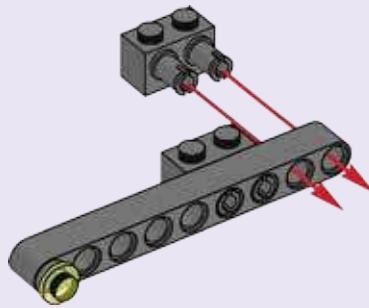

3

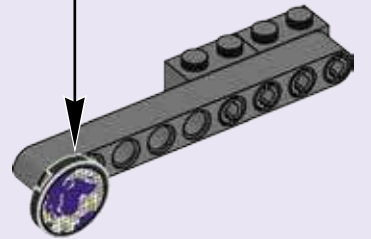

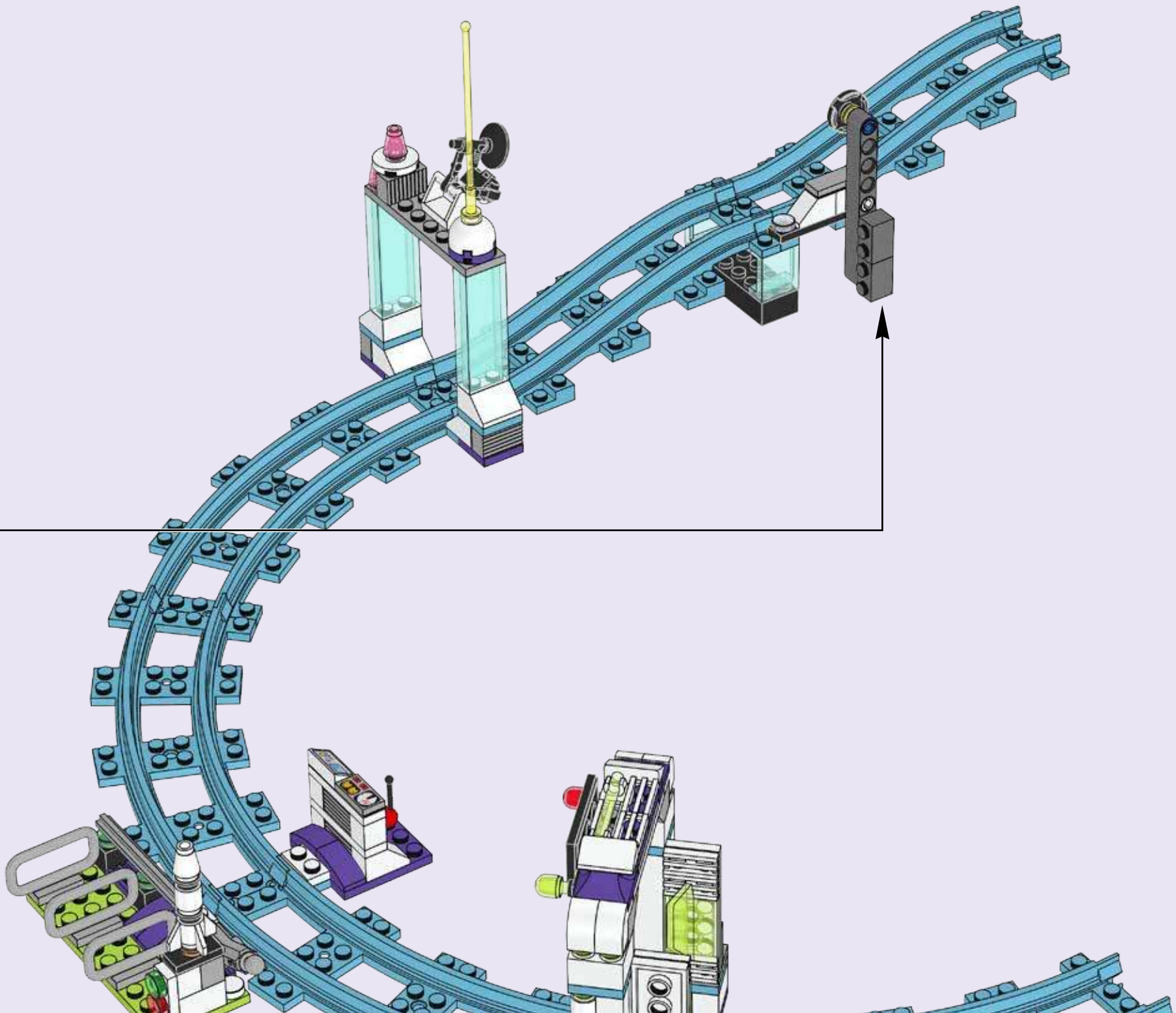

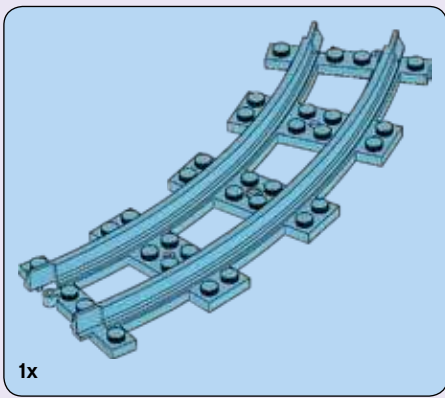

65

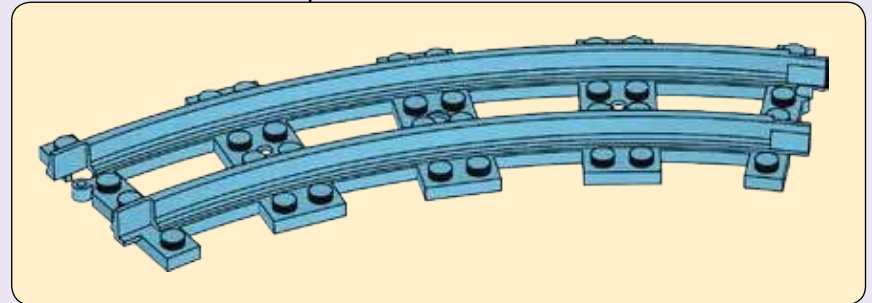
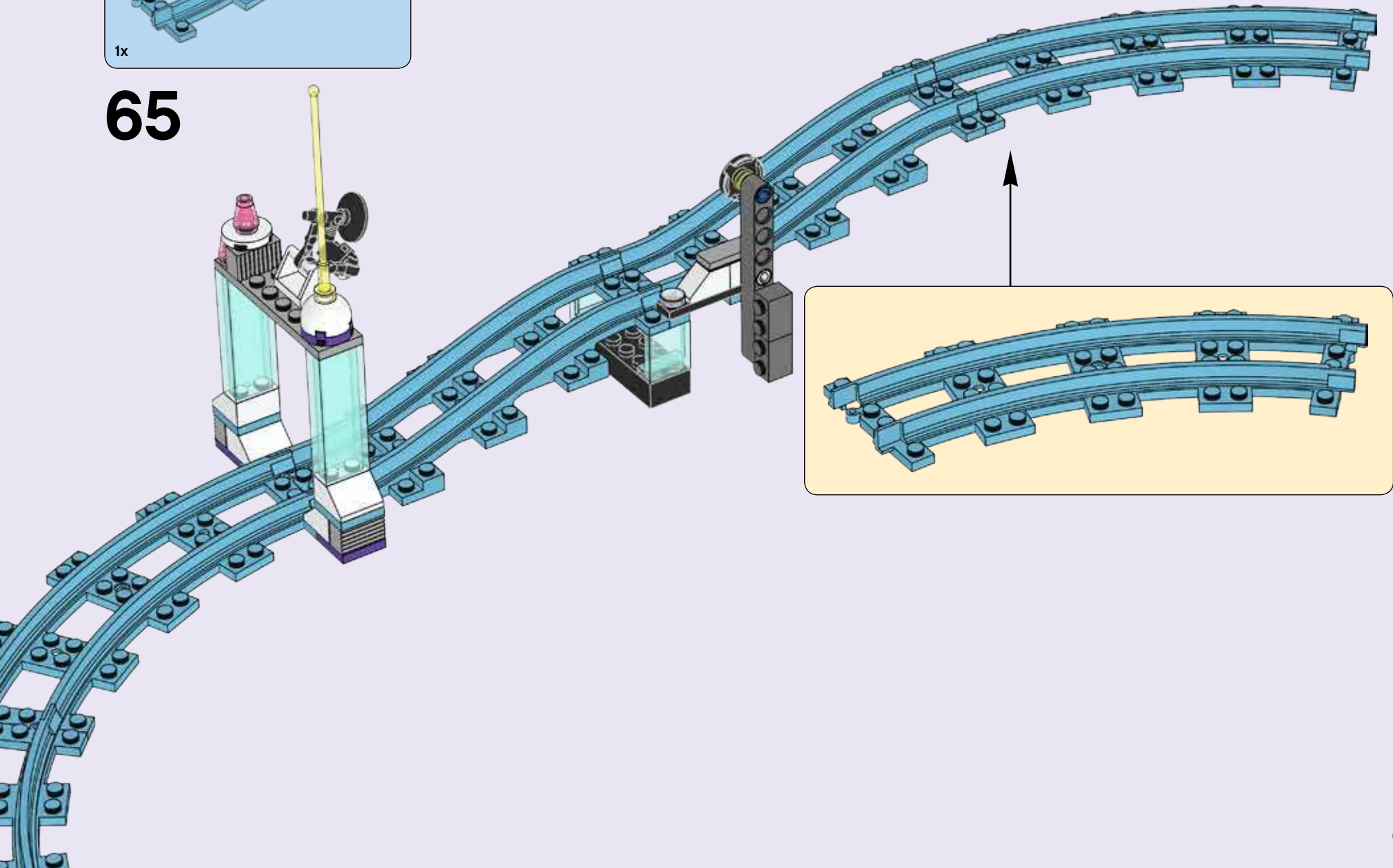

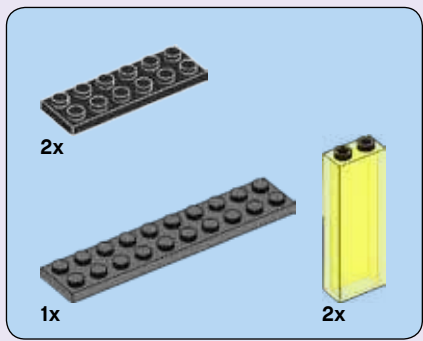

# 66

1

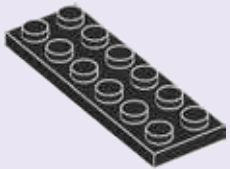

2

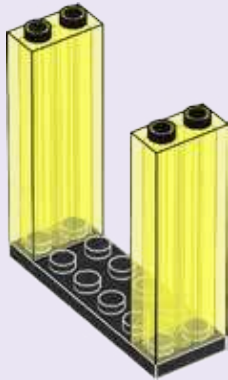

3

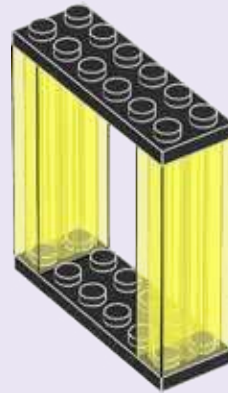

4

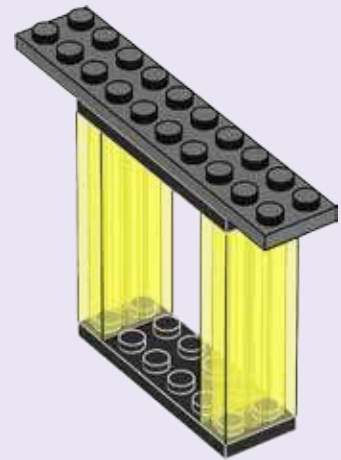

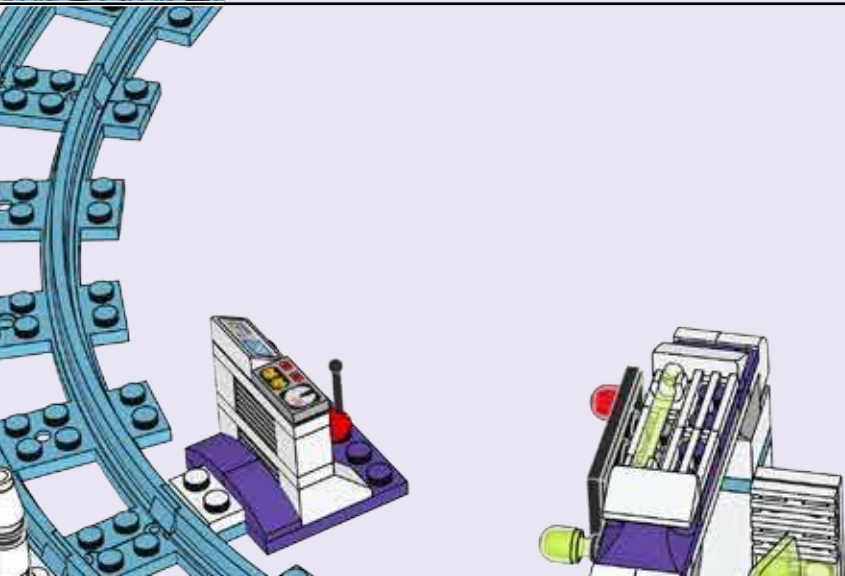
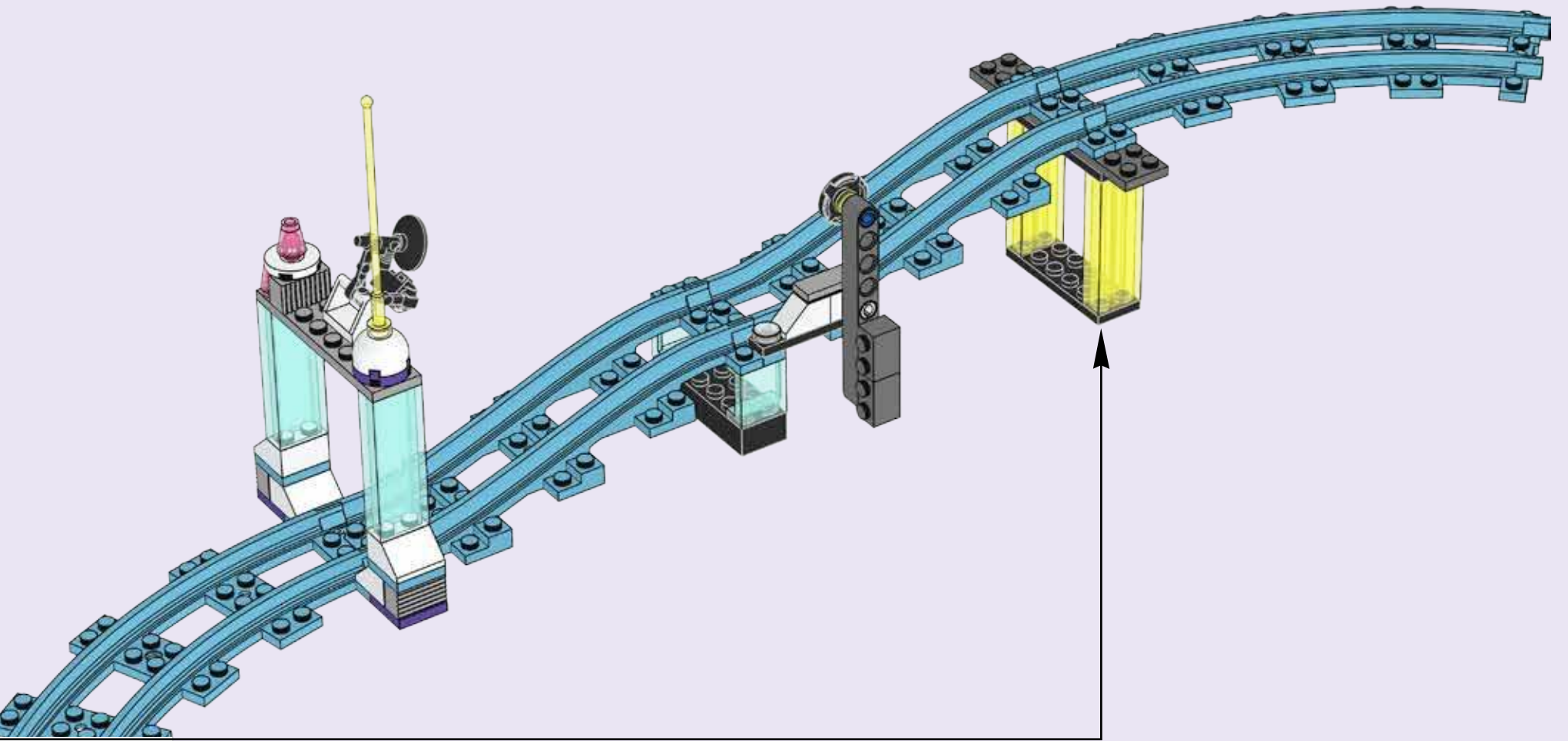





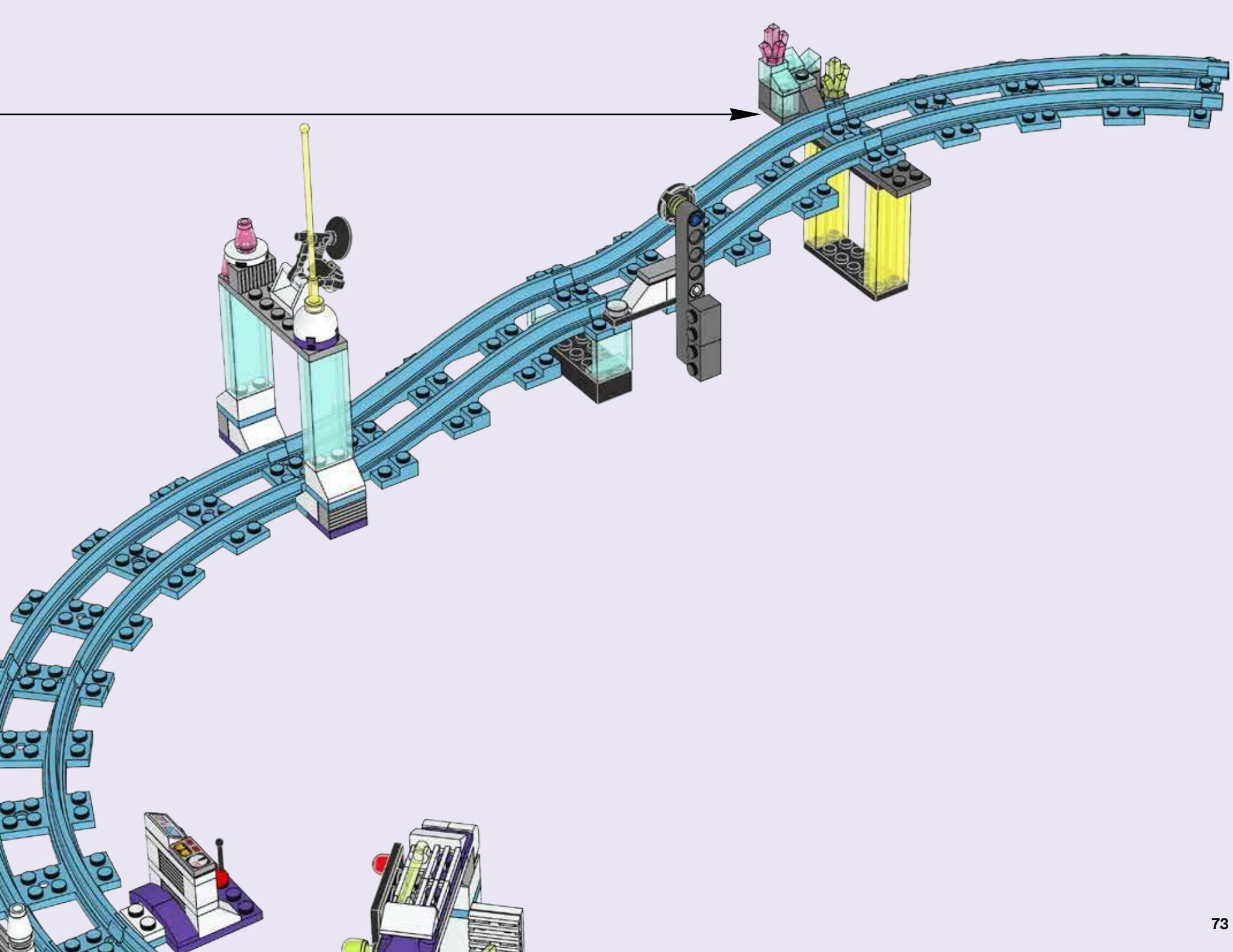

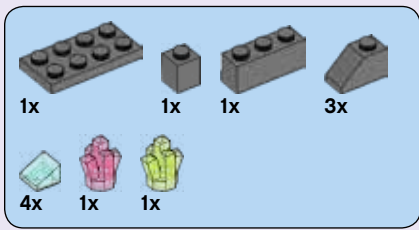

# 68

1

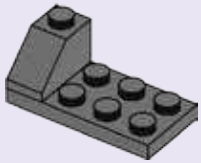

2

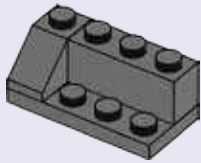

3



4

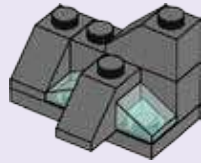

5



6



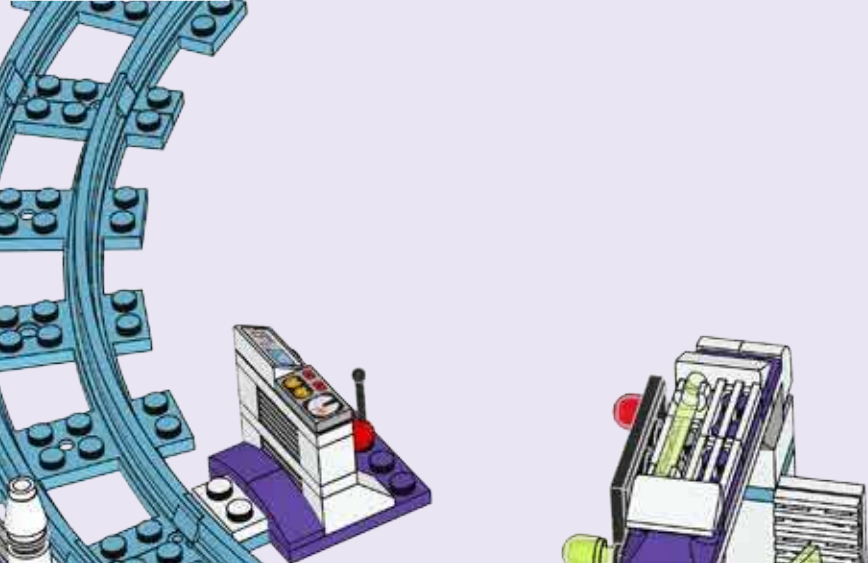
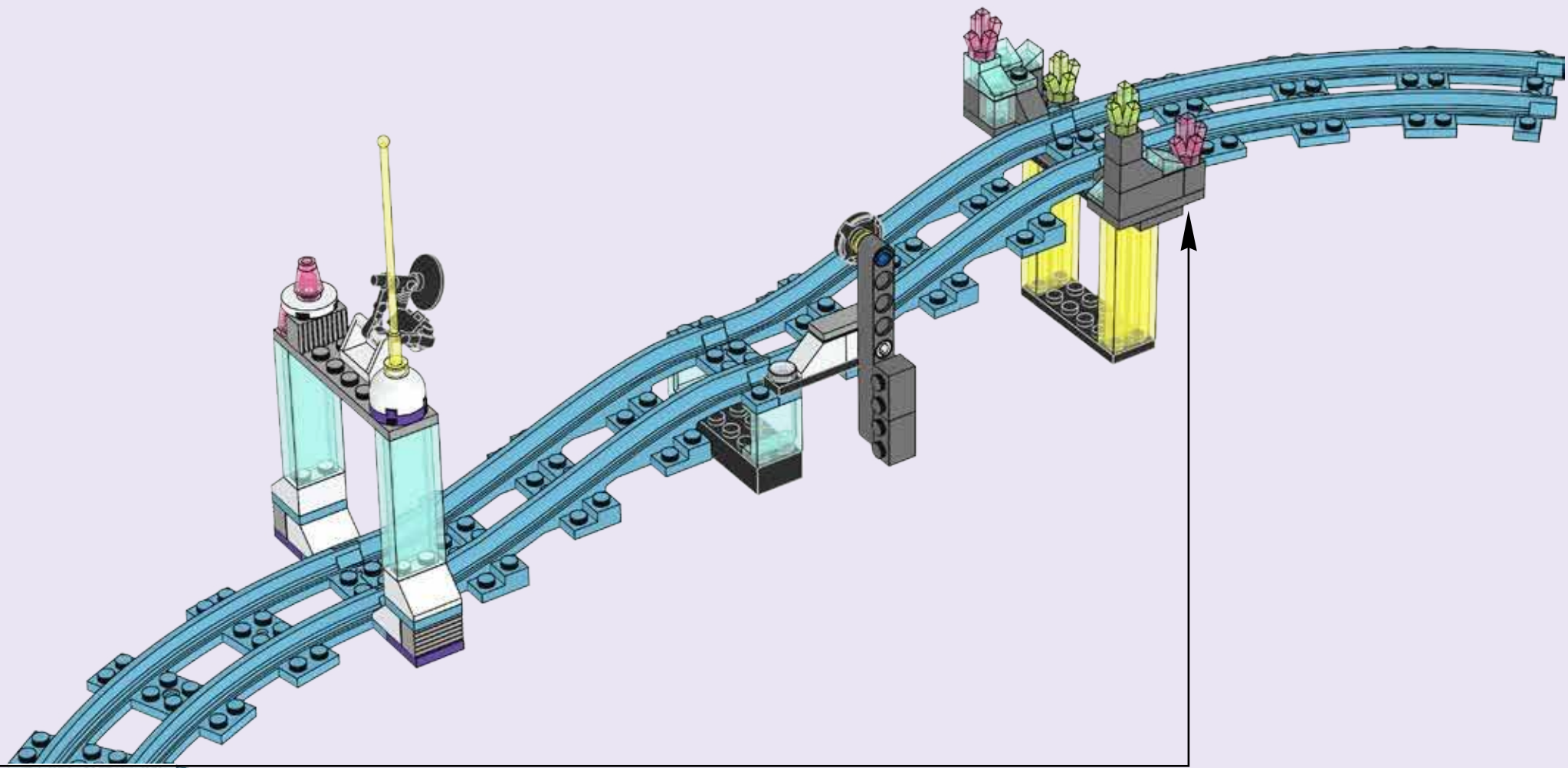

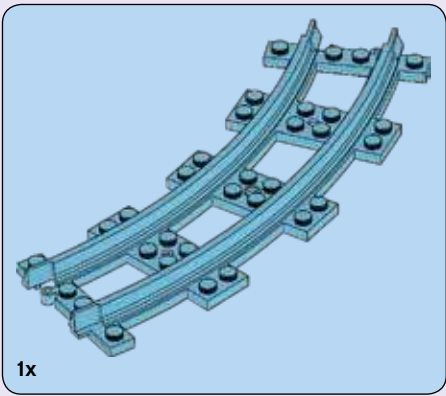

69

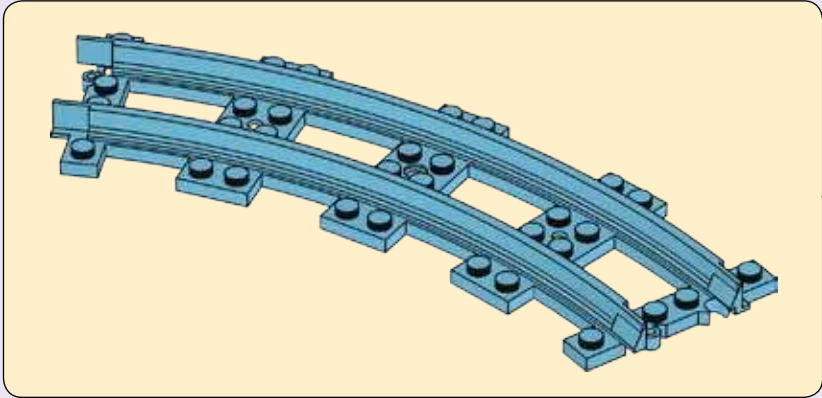
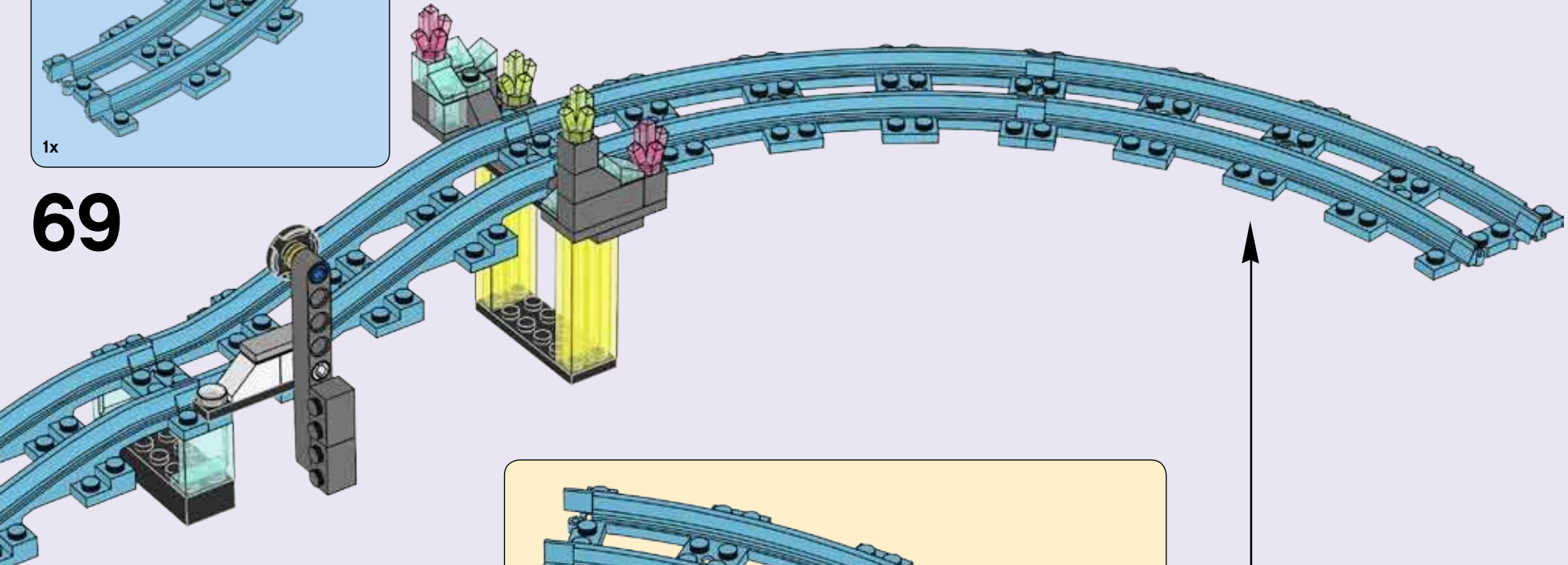

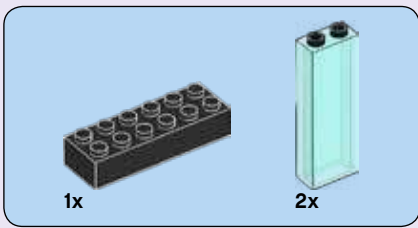

70

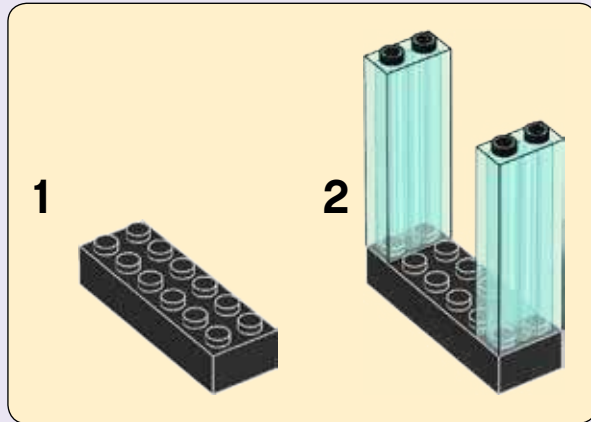
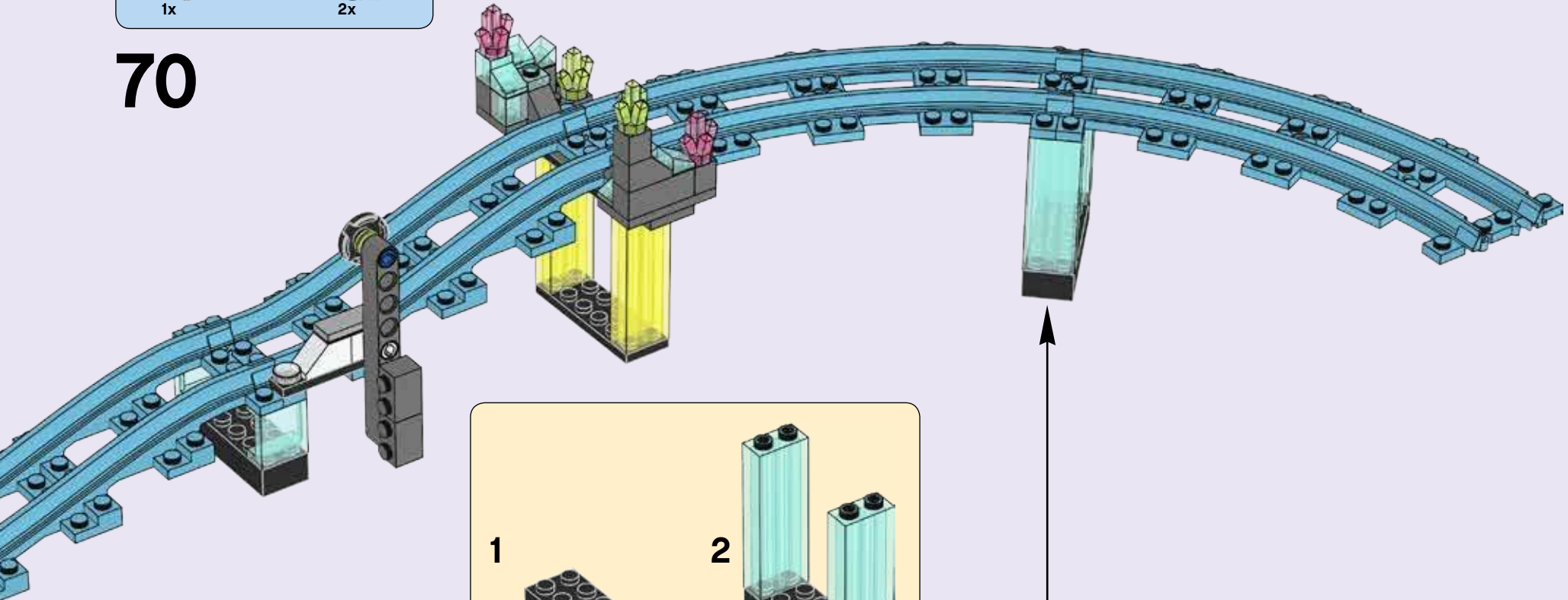

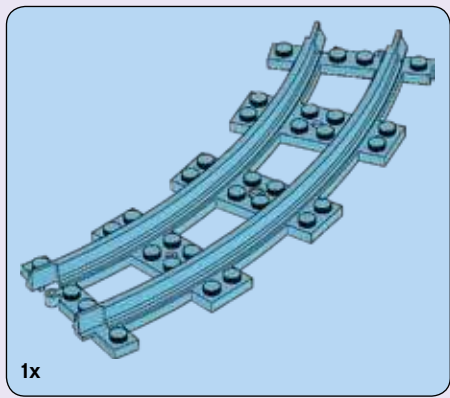

71

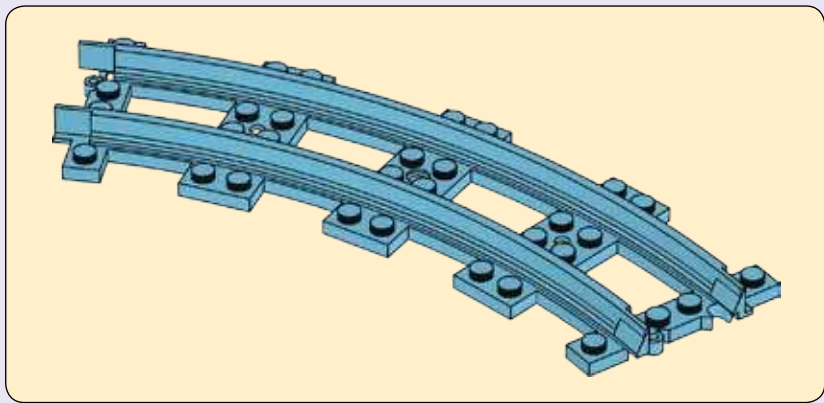
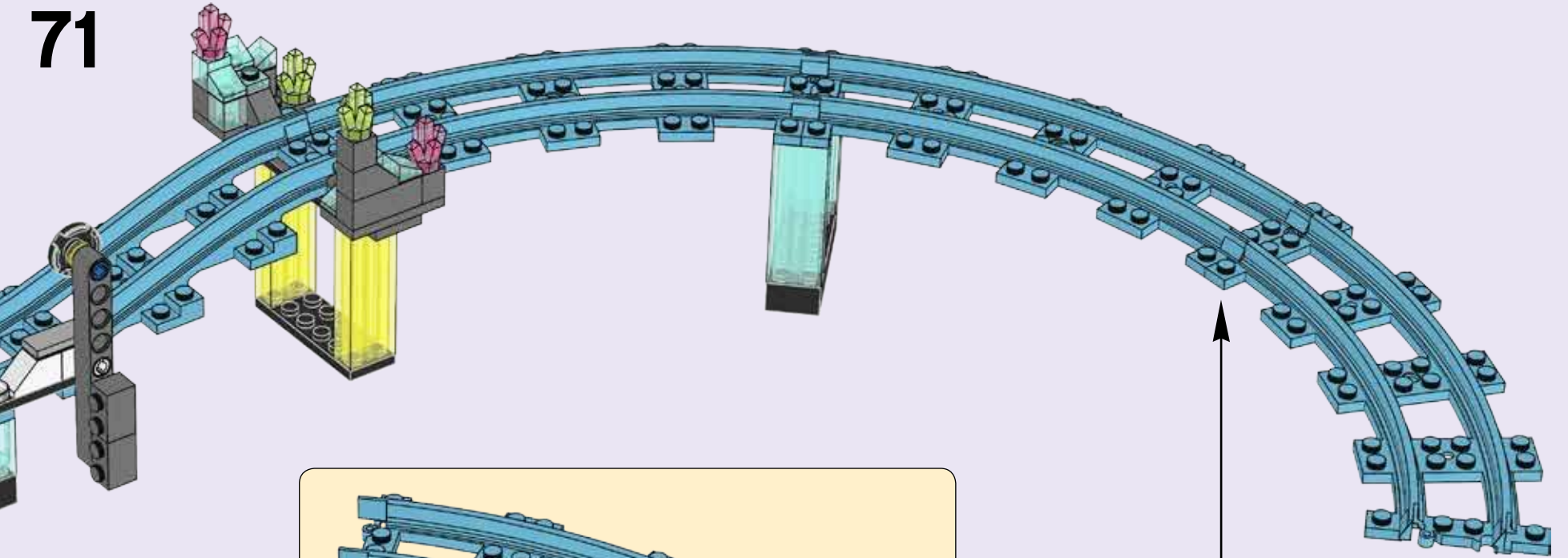

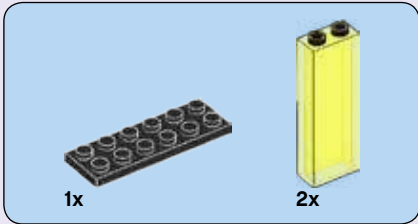
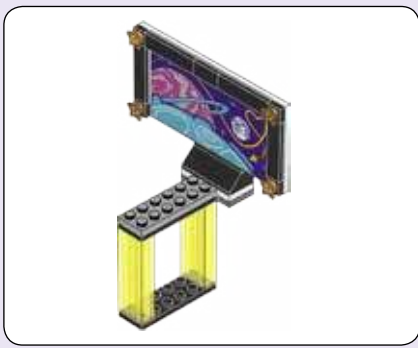

72

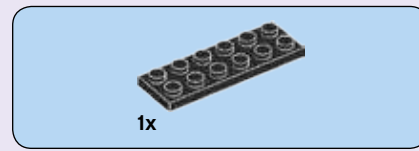
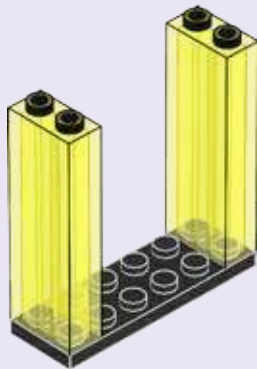

73

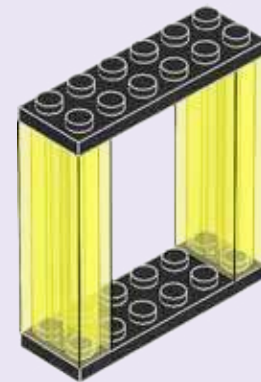

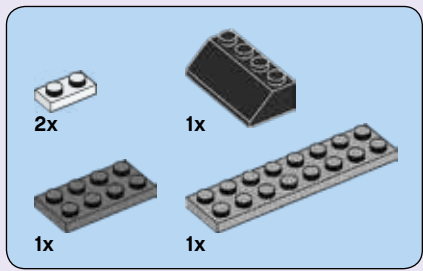

74

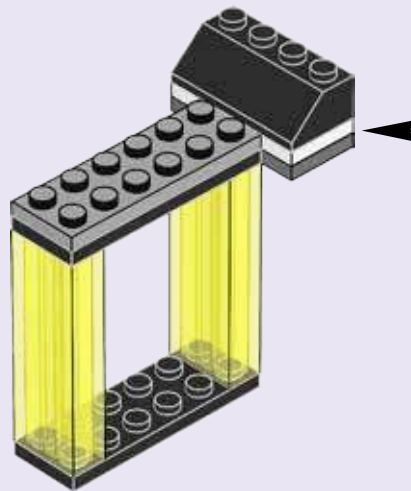
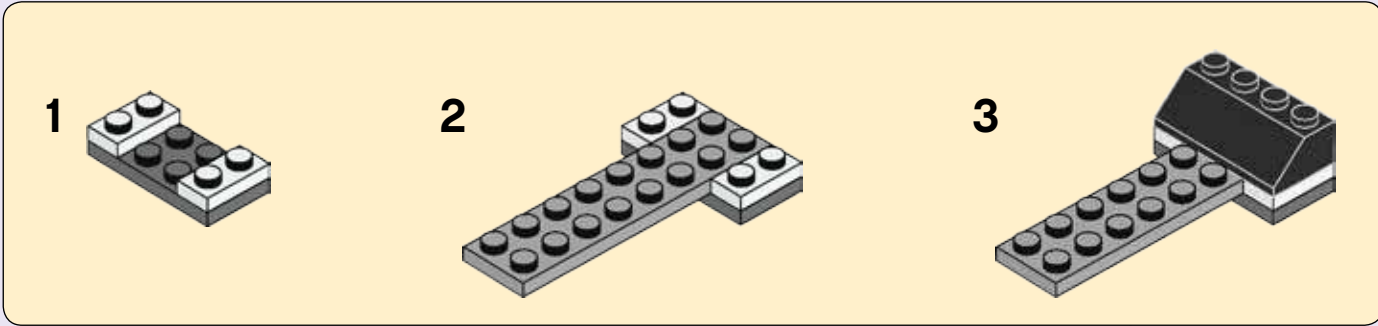



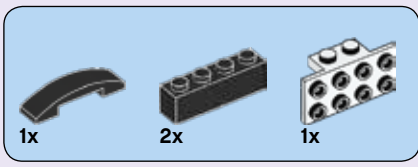

# 75

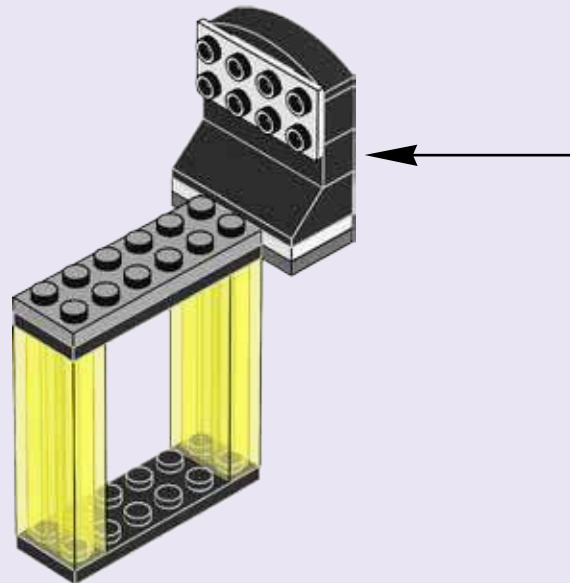
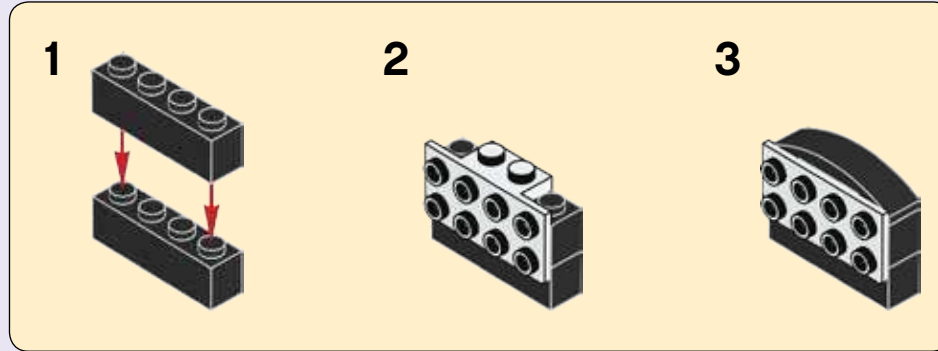

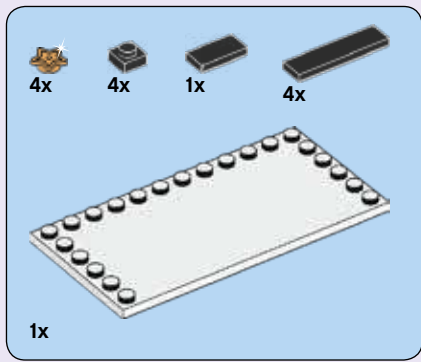

# 76

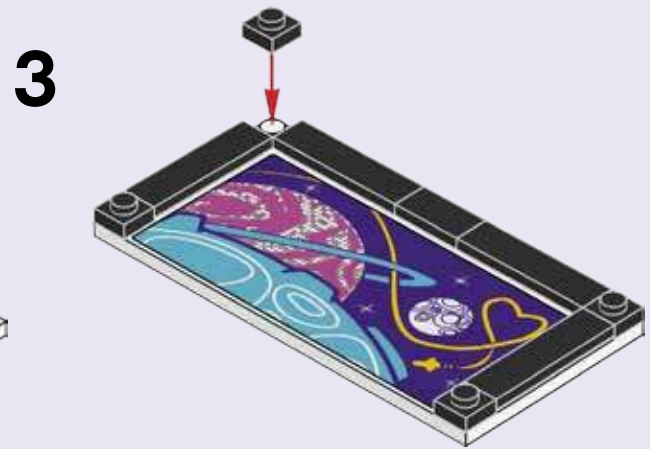
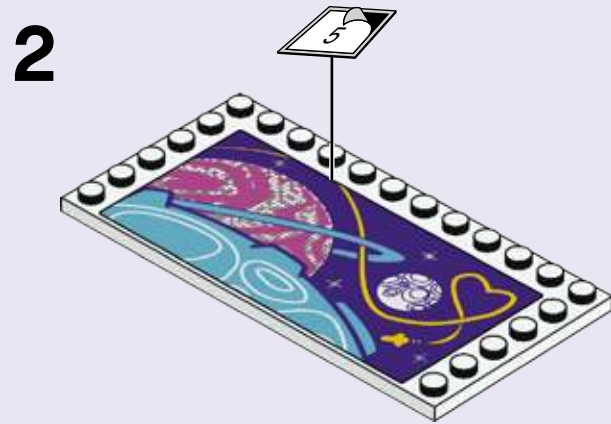
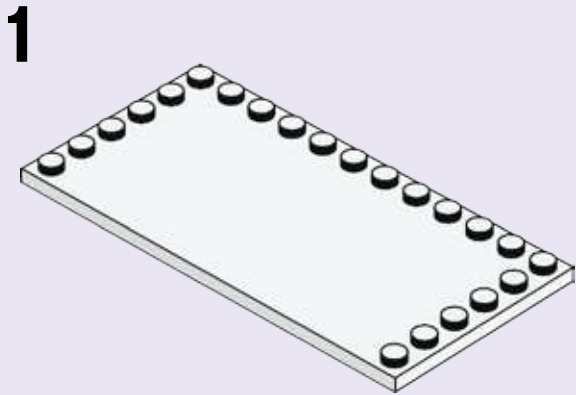

4

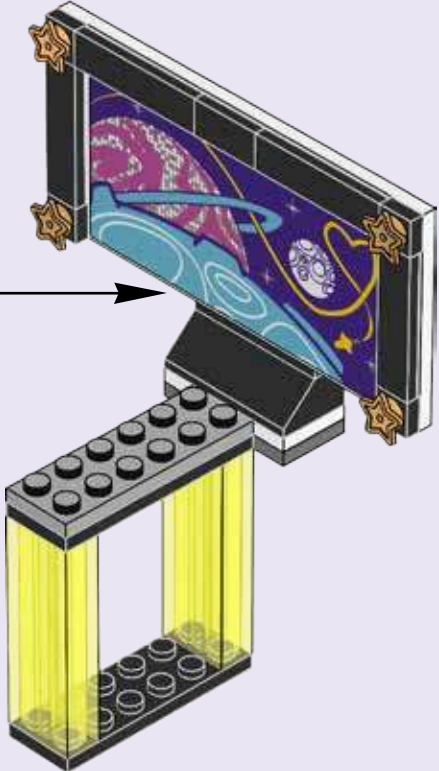

77

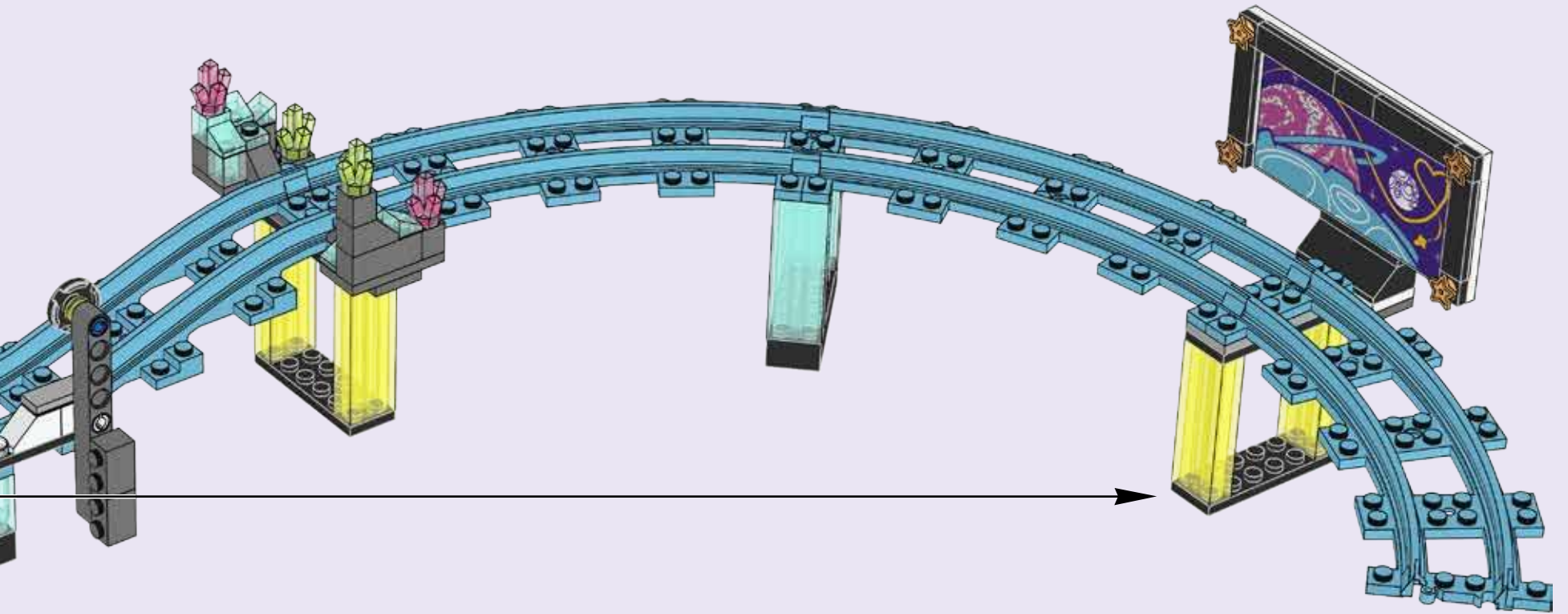

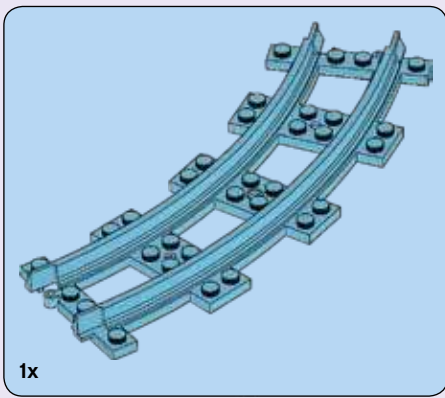

78

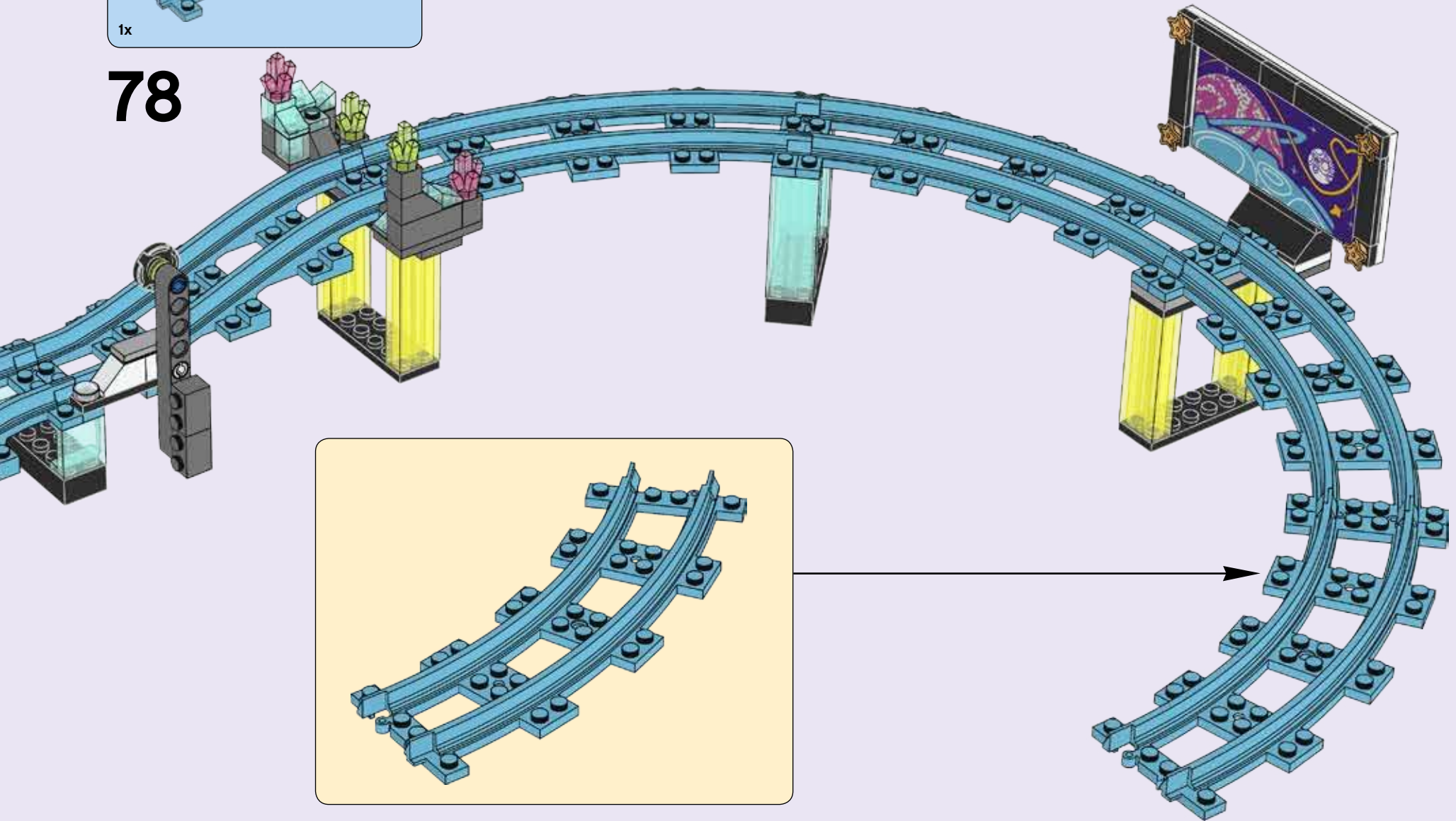

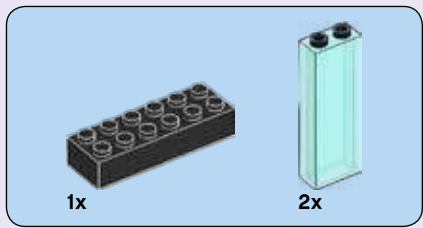

79

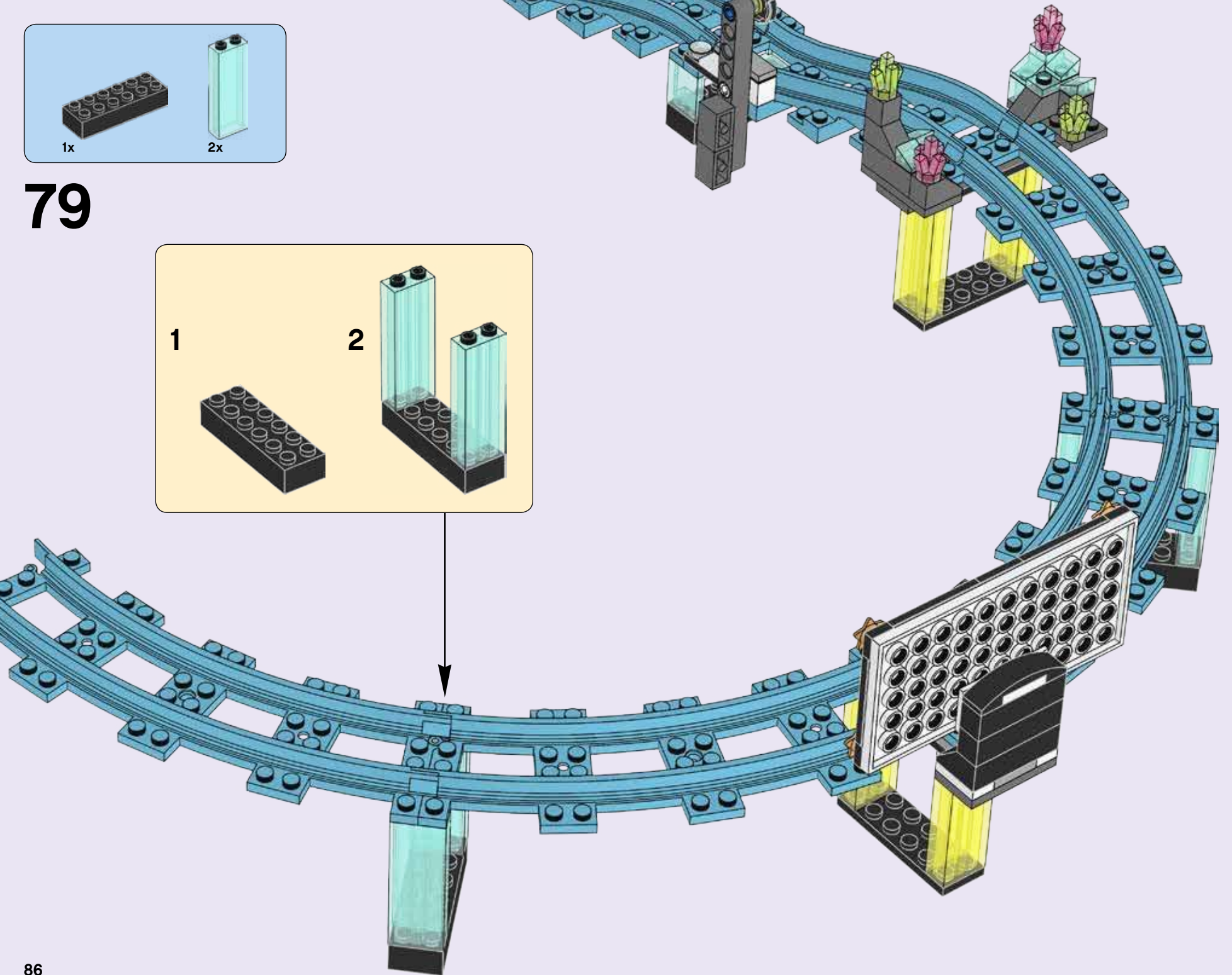
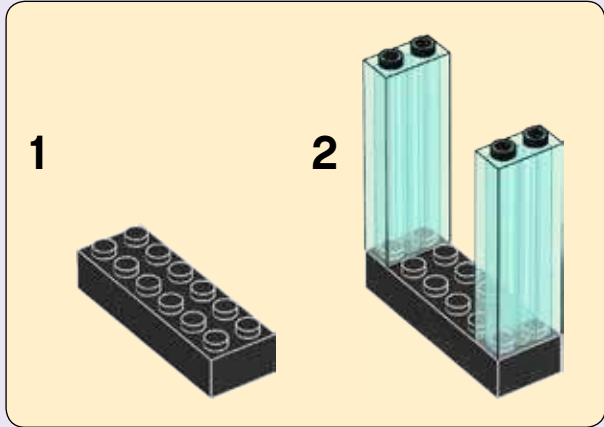

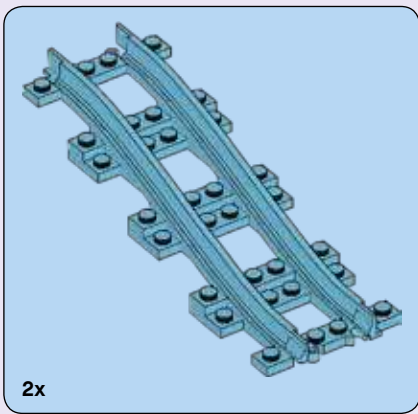

80

1

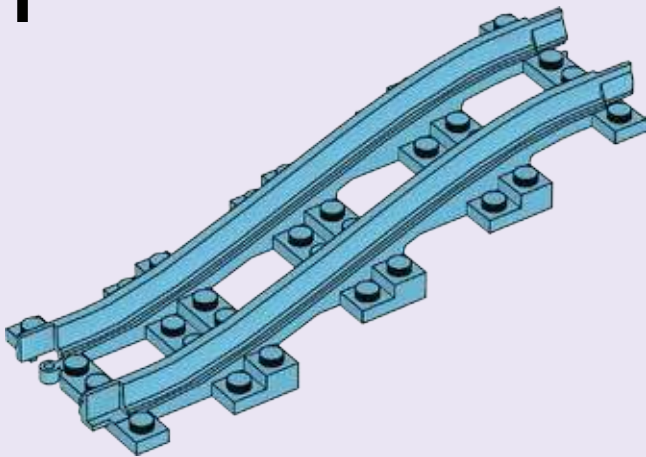

2

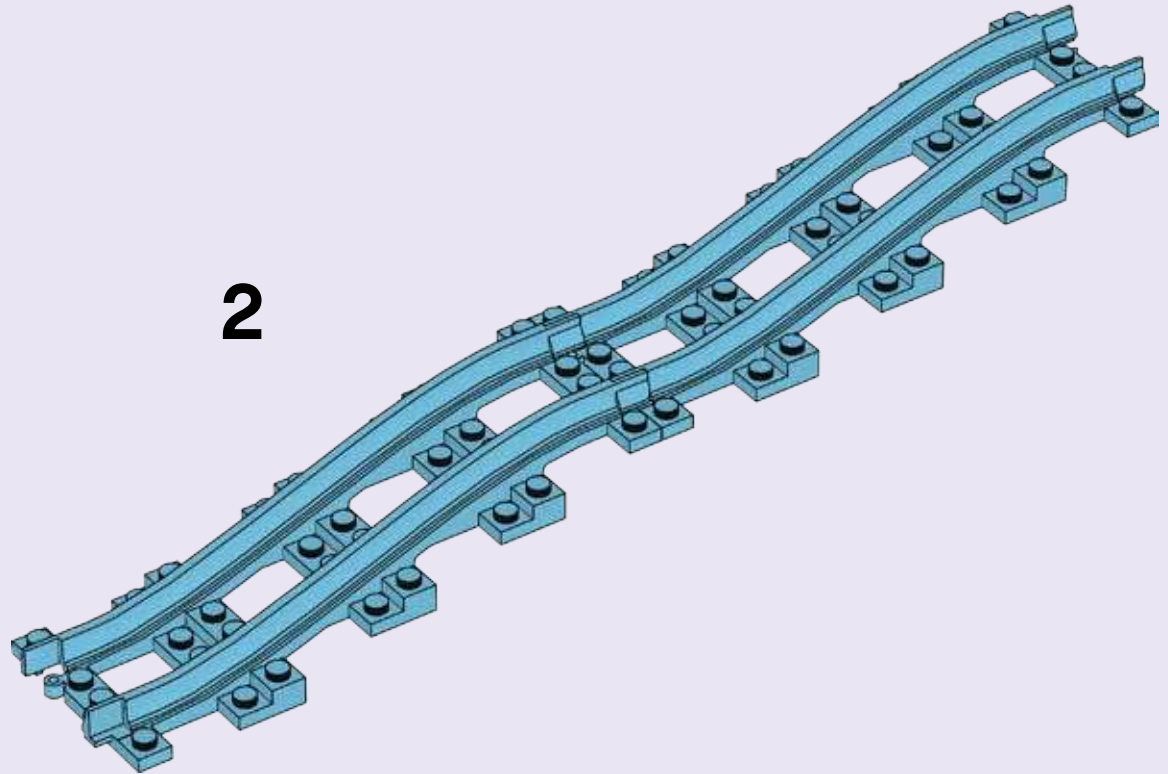

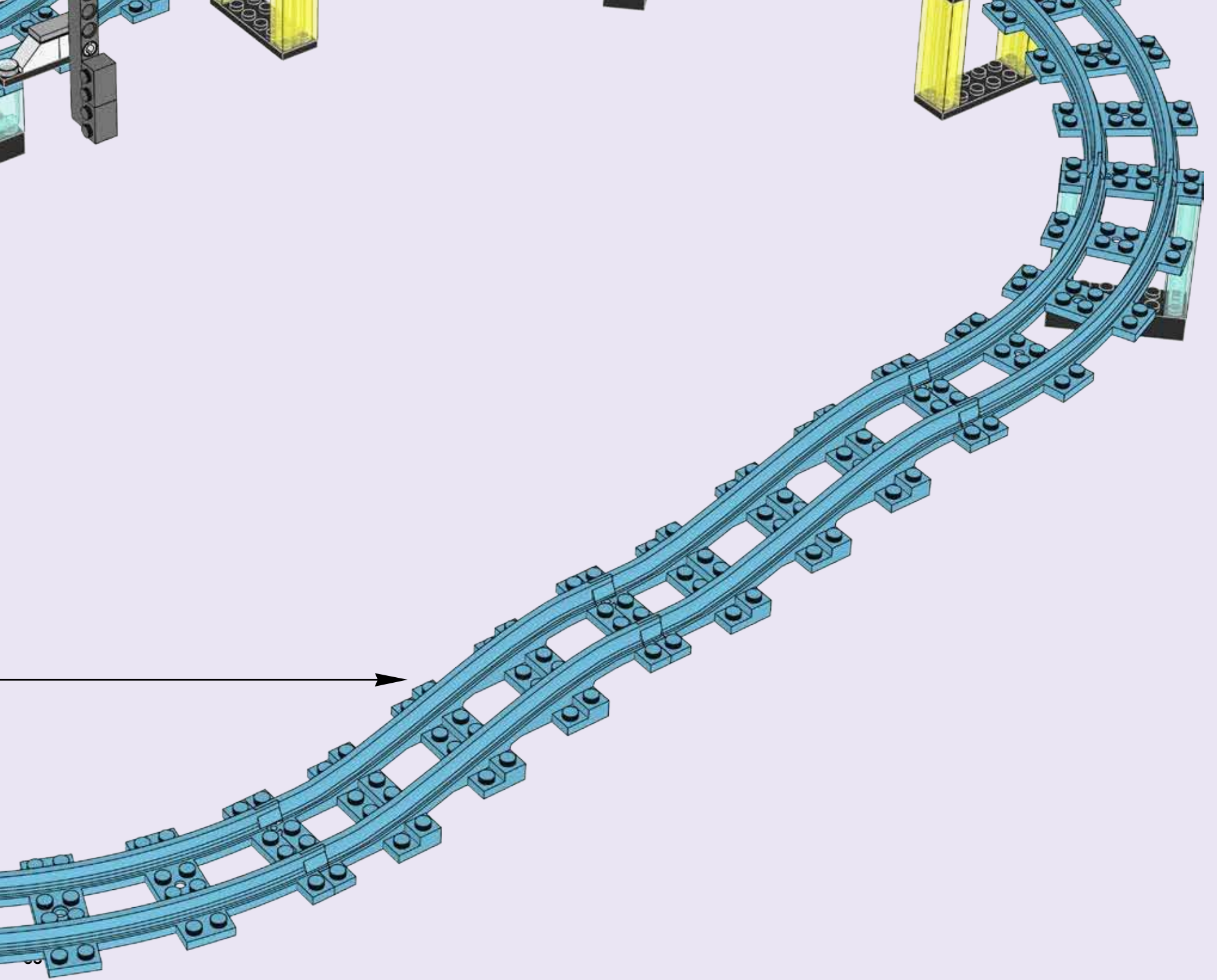



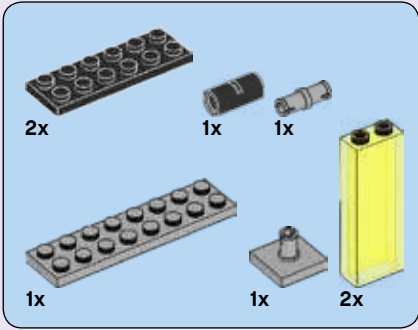
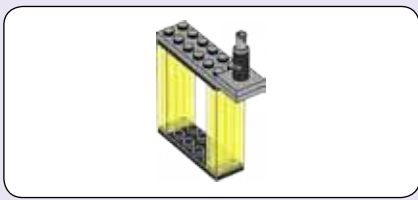

81

1

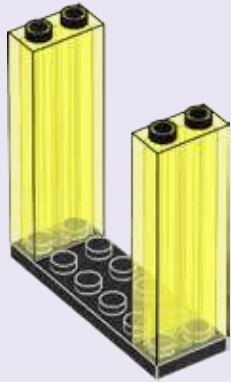

2

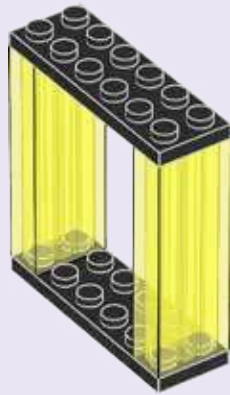

3

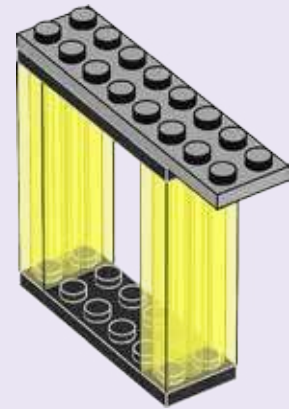

4

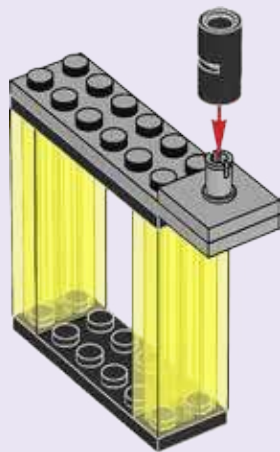

5

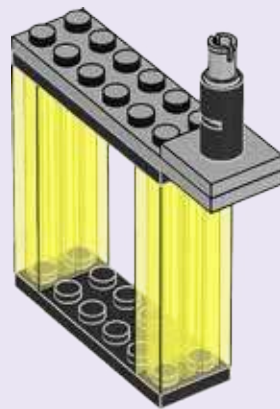

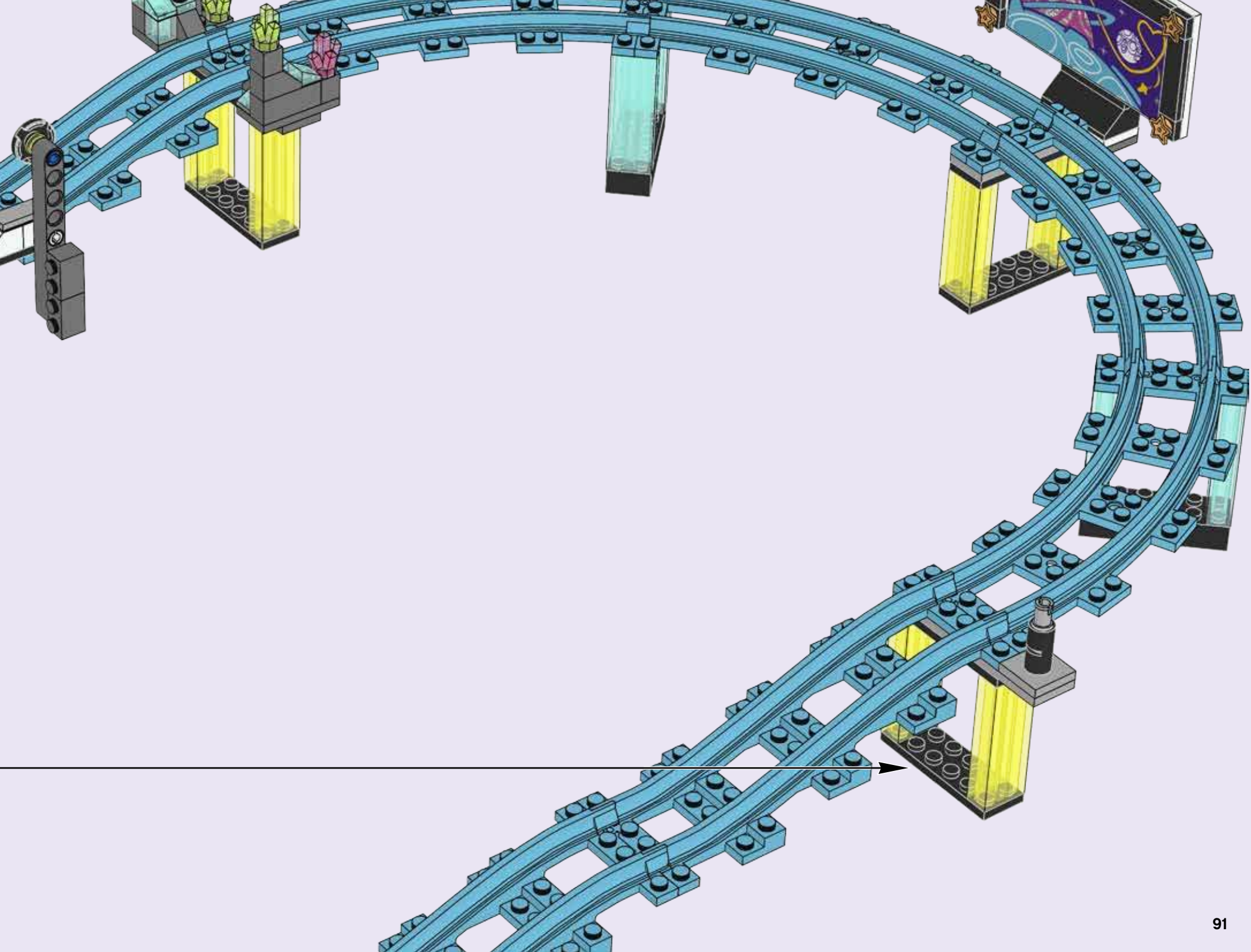

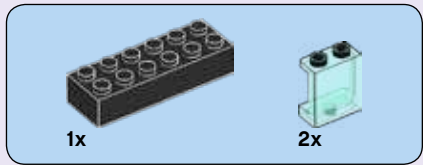

82

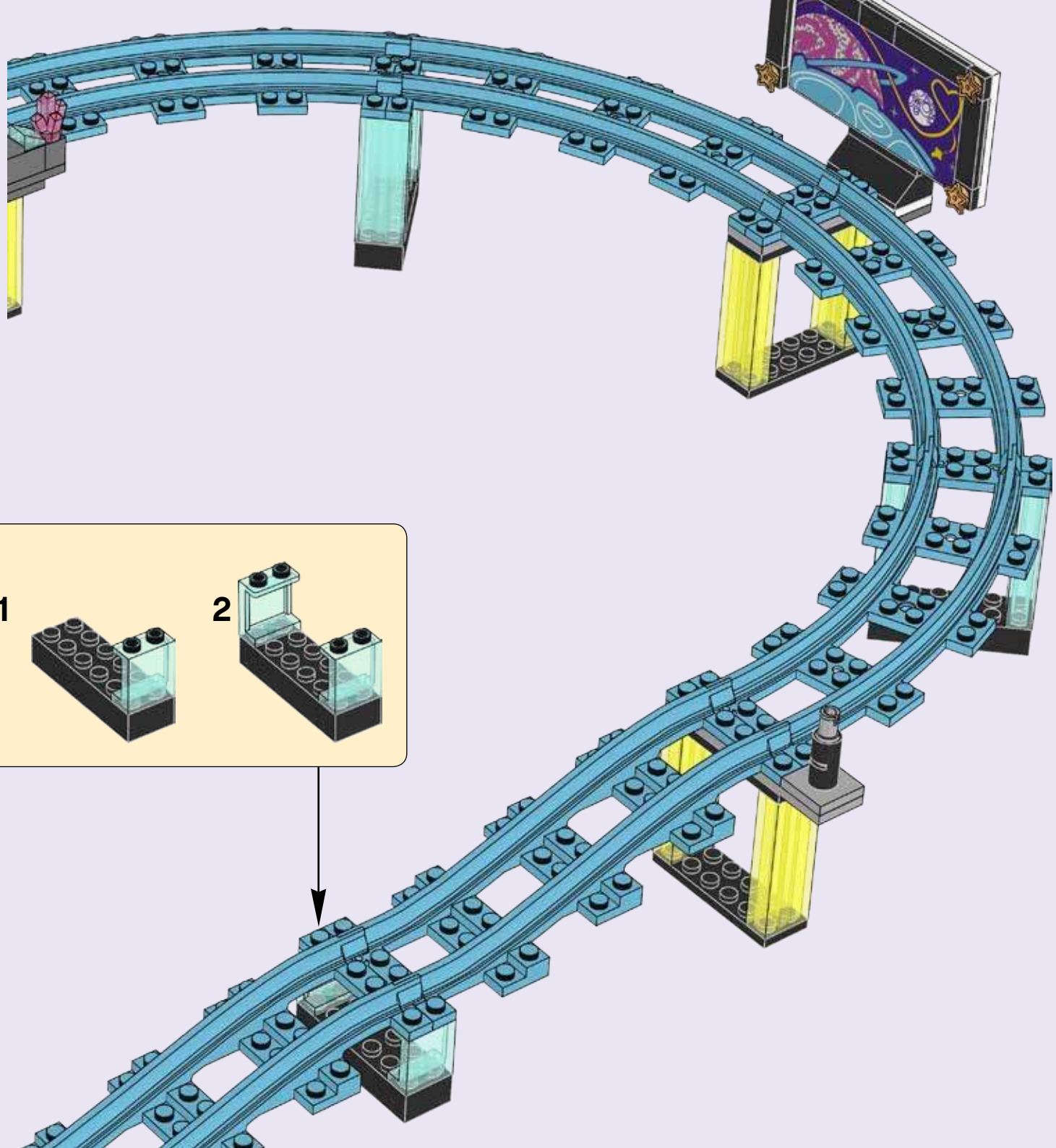

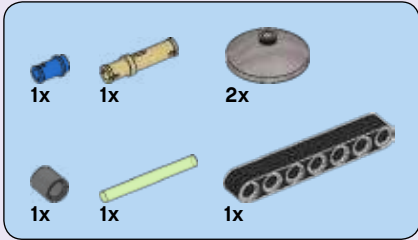

83

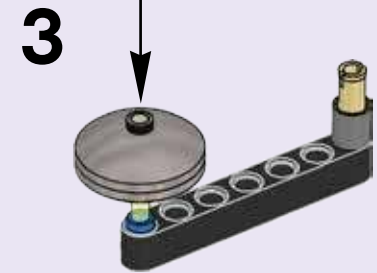
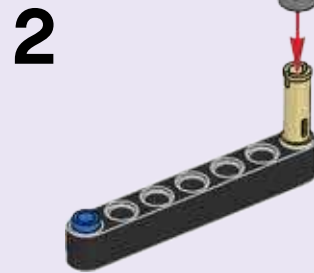
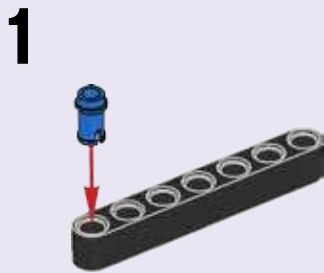
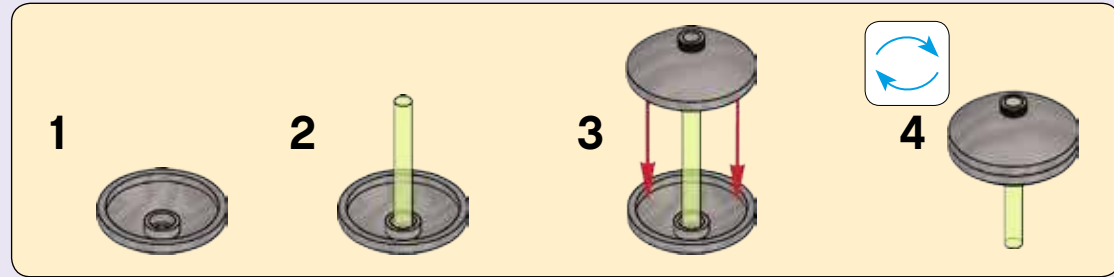

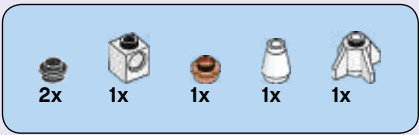

# 84

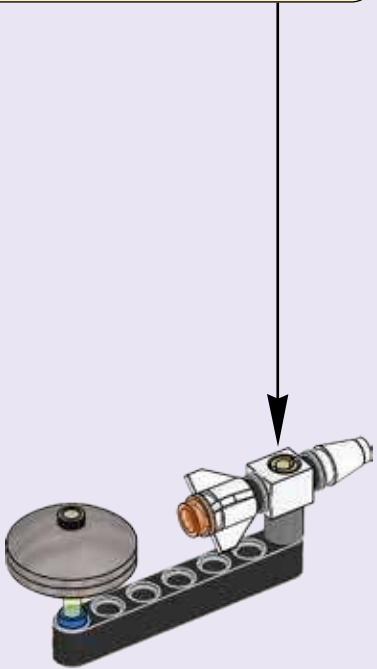
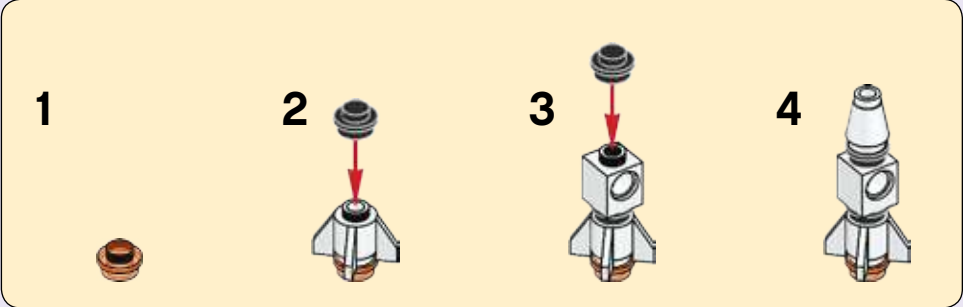

85

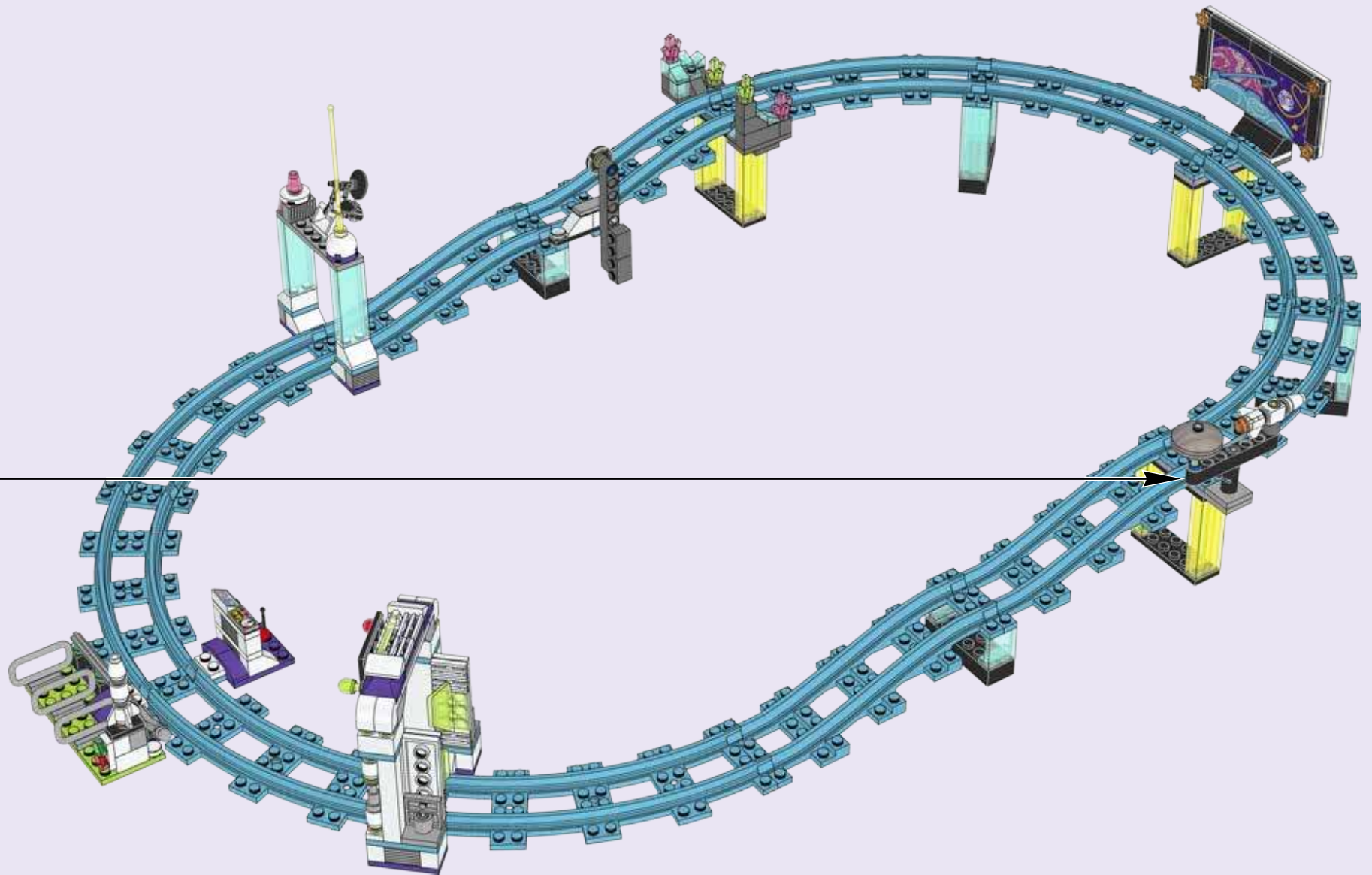

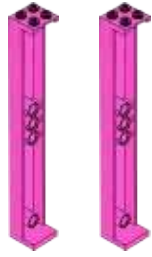
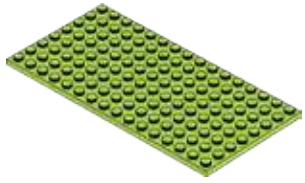

+

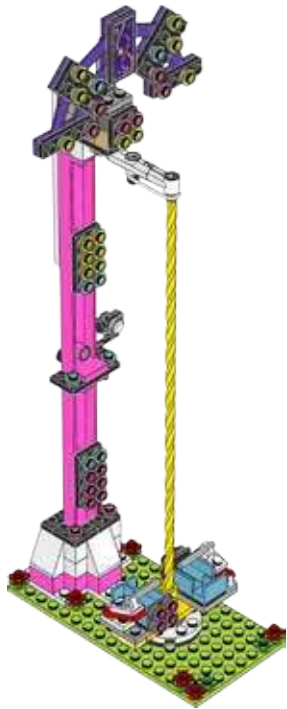

1

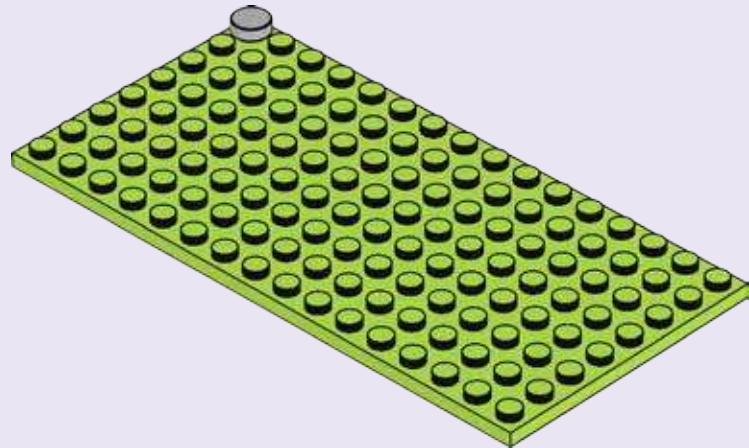





2

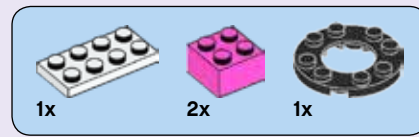
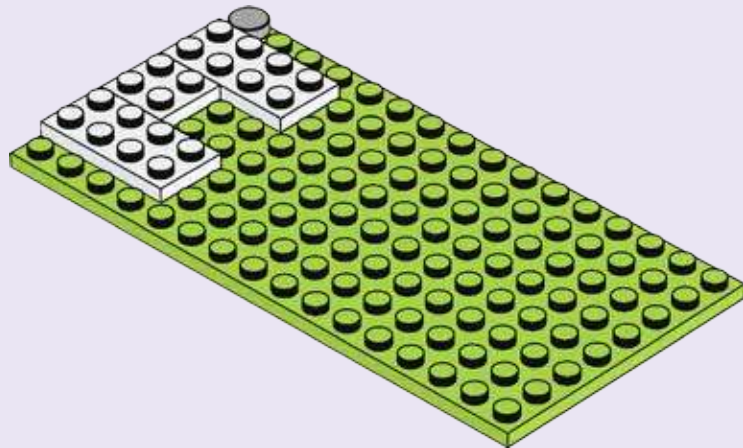

3

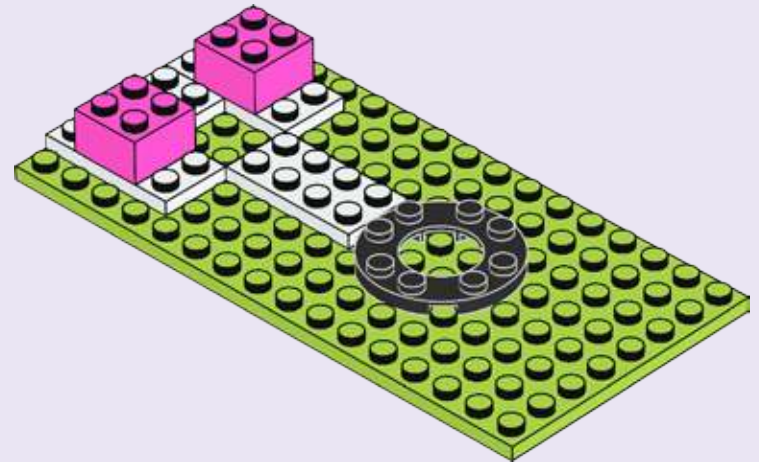

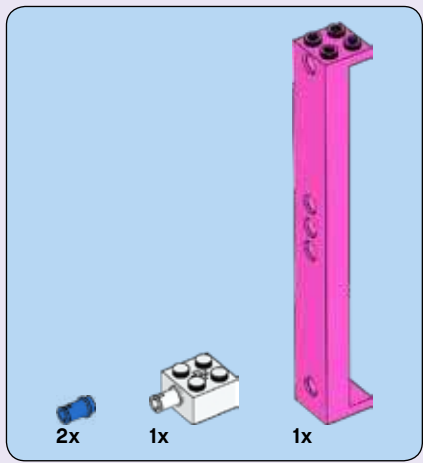

4

1

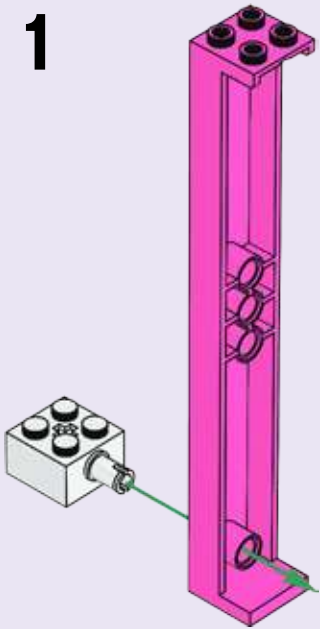

2

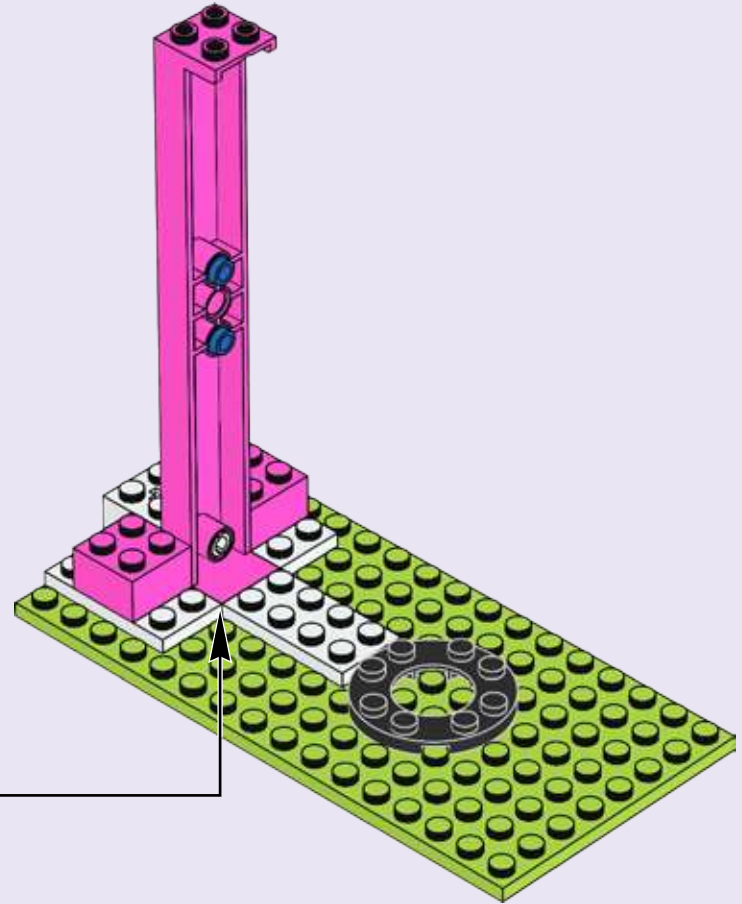
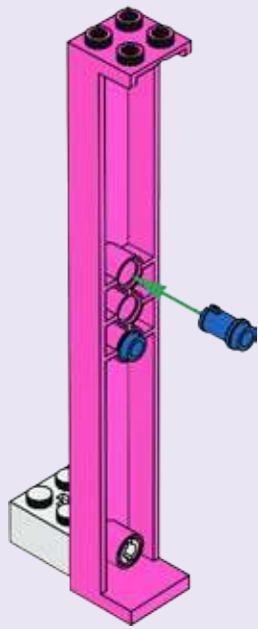

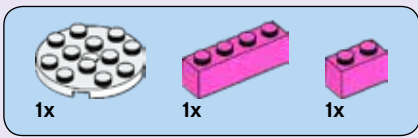

5

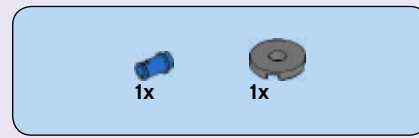
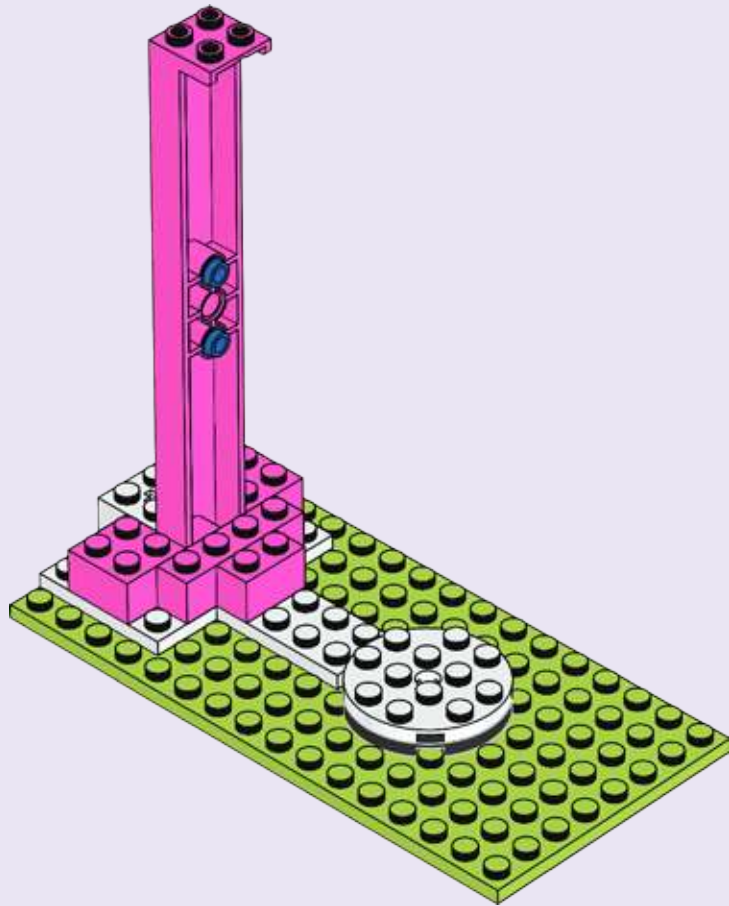

6

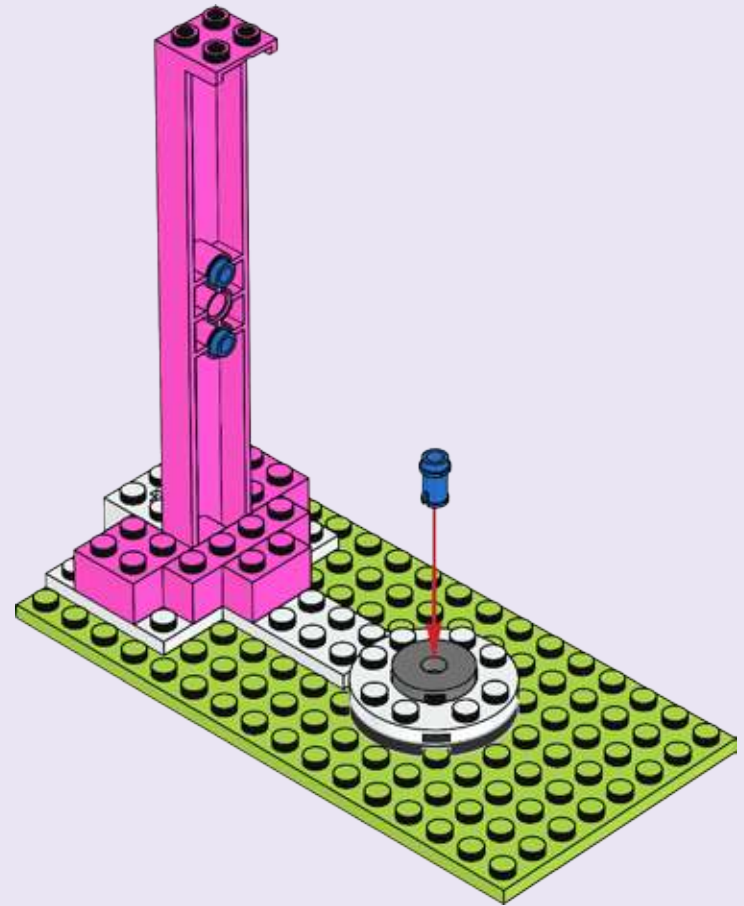

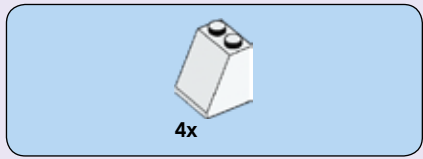

7

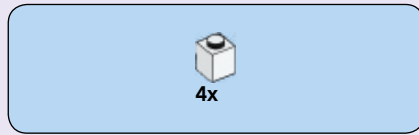
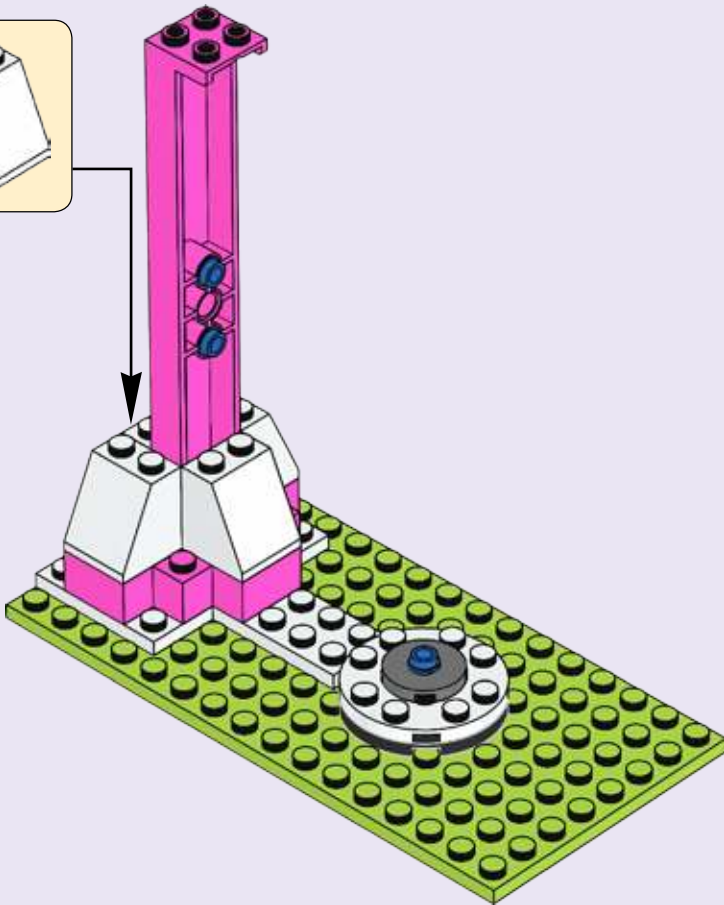
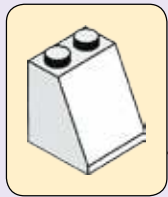

8

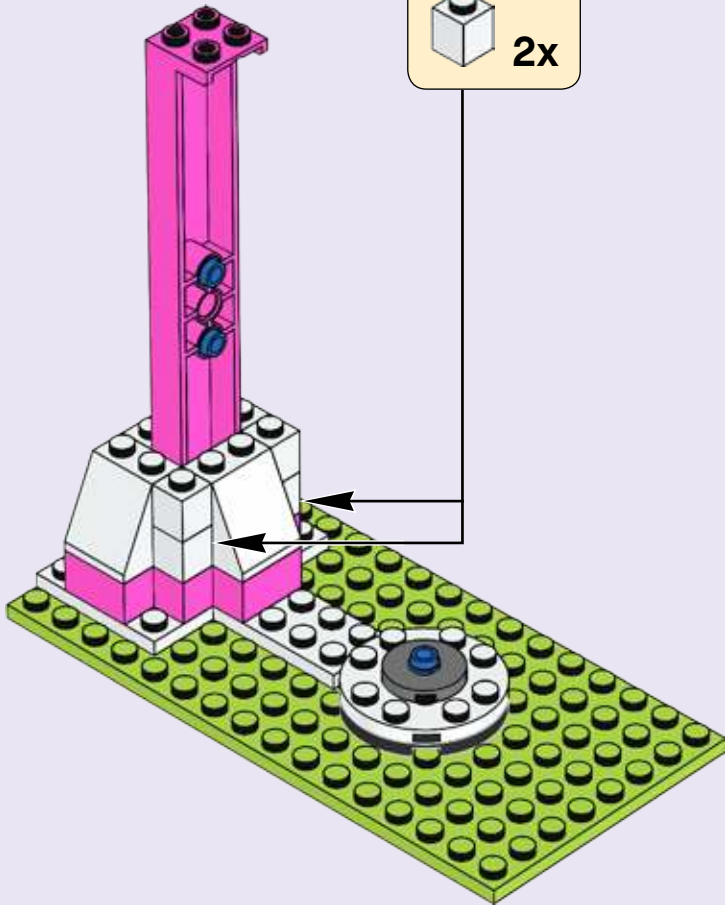
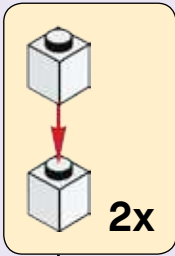

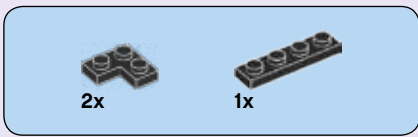

9

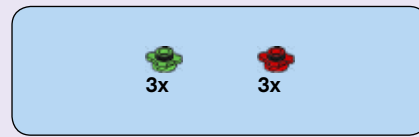
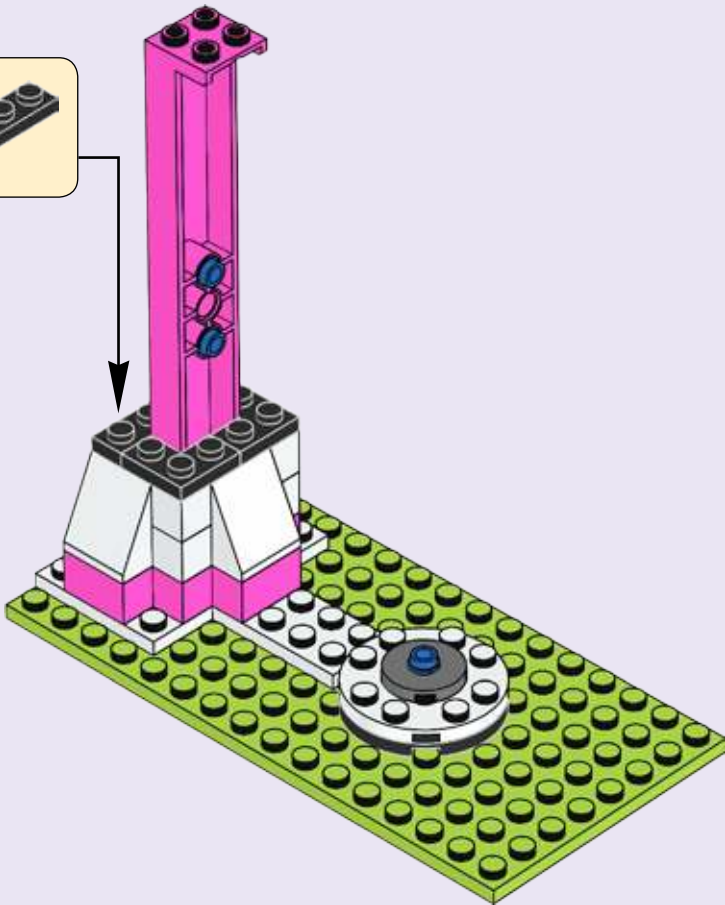
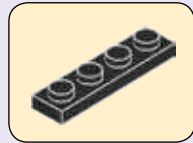

10

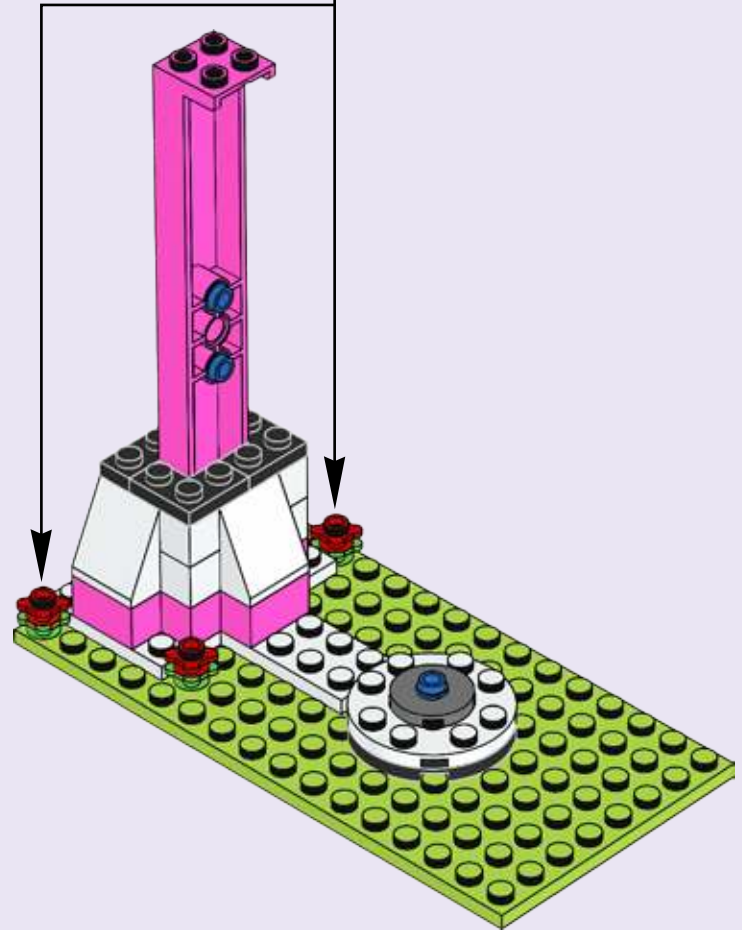
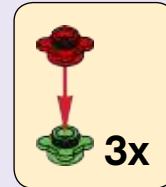



4x



1x

# 11

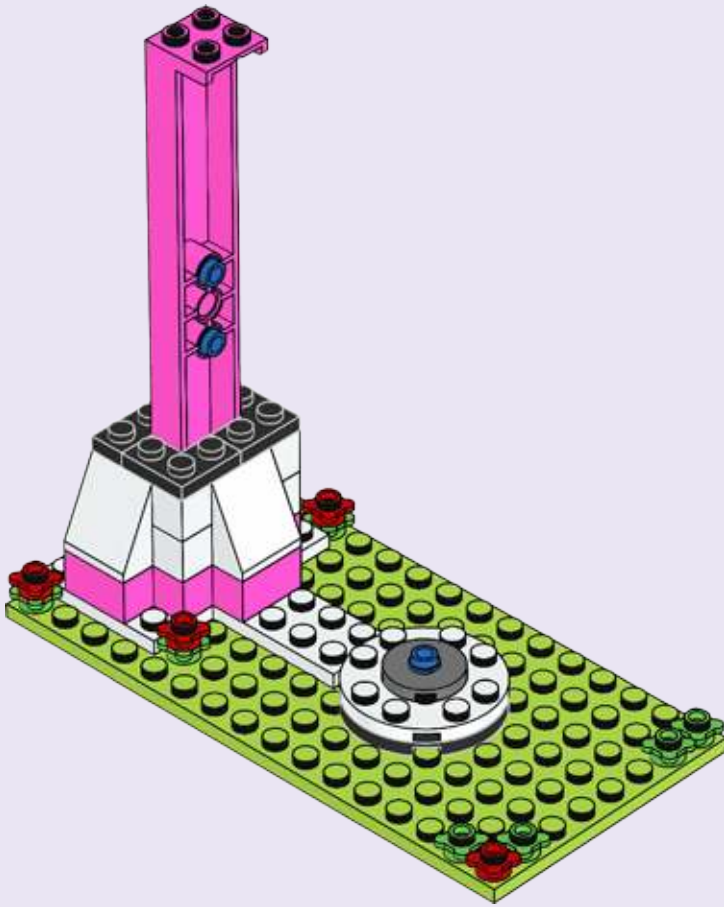

2x



2x

# 12





# 13

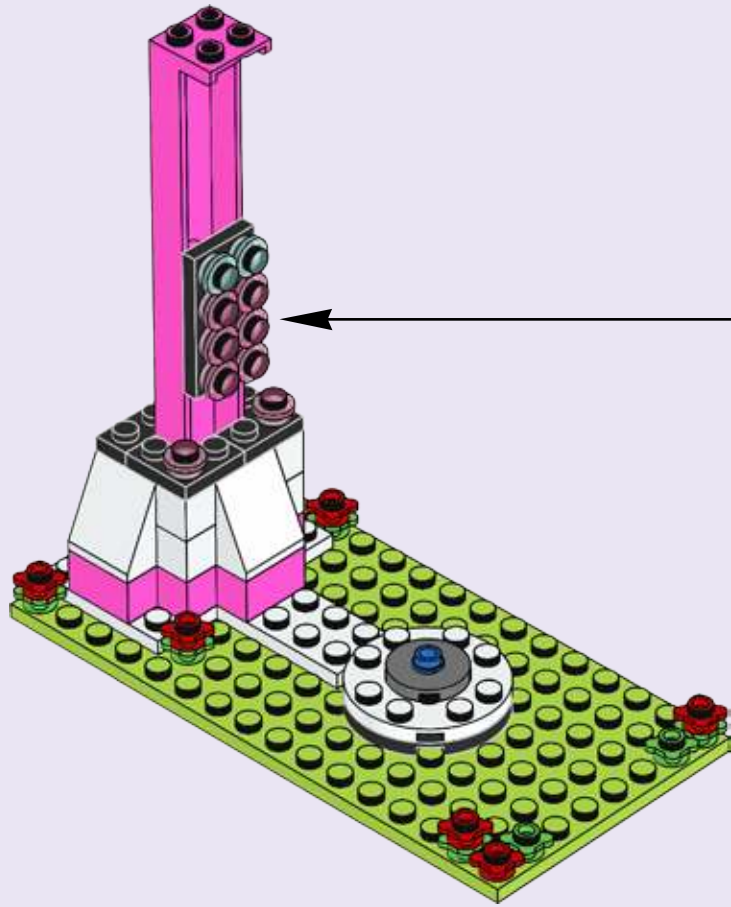
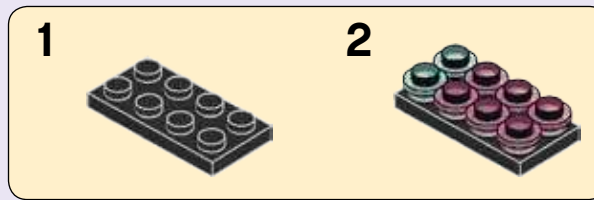

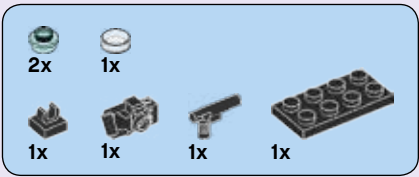

# 14

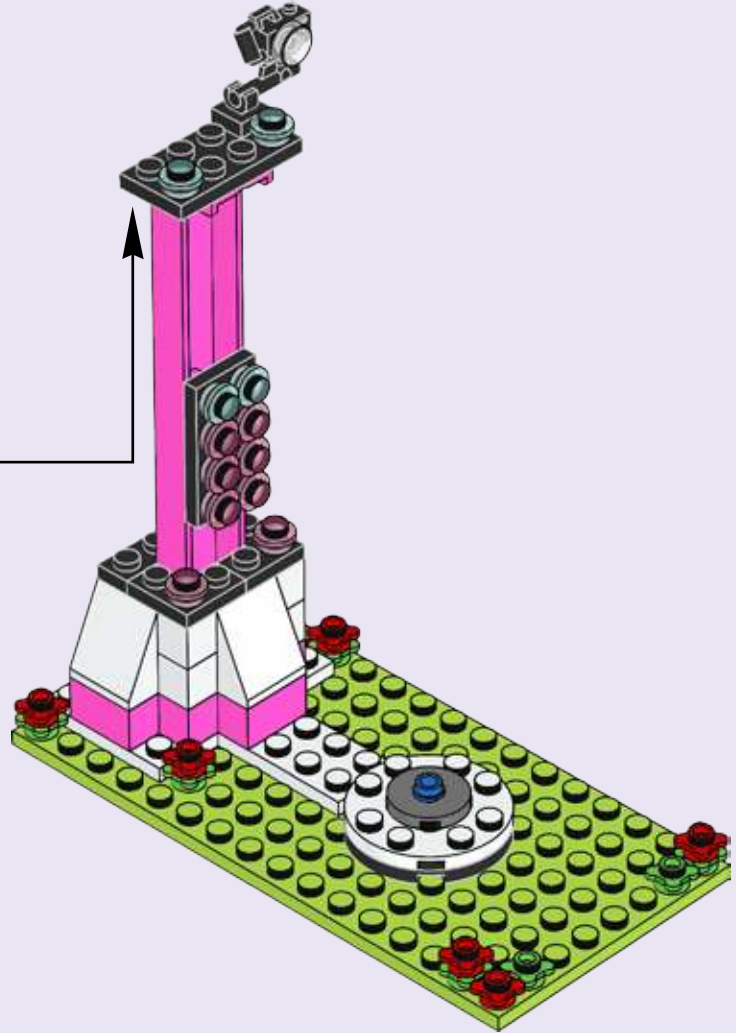
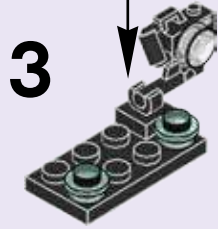
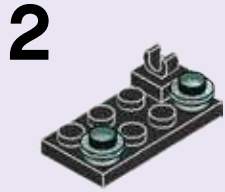
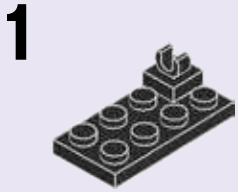
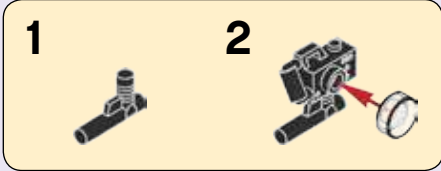



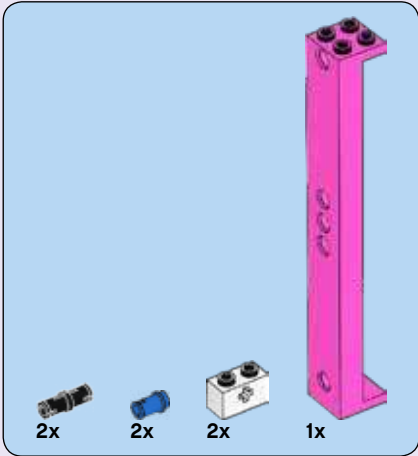

15

1

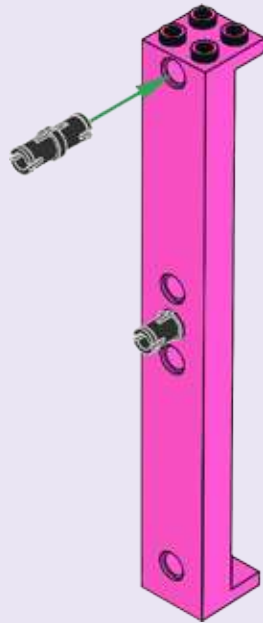

2

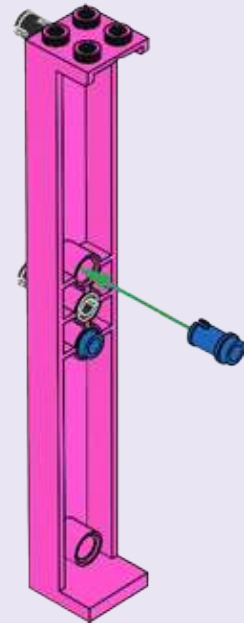

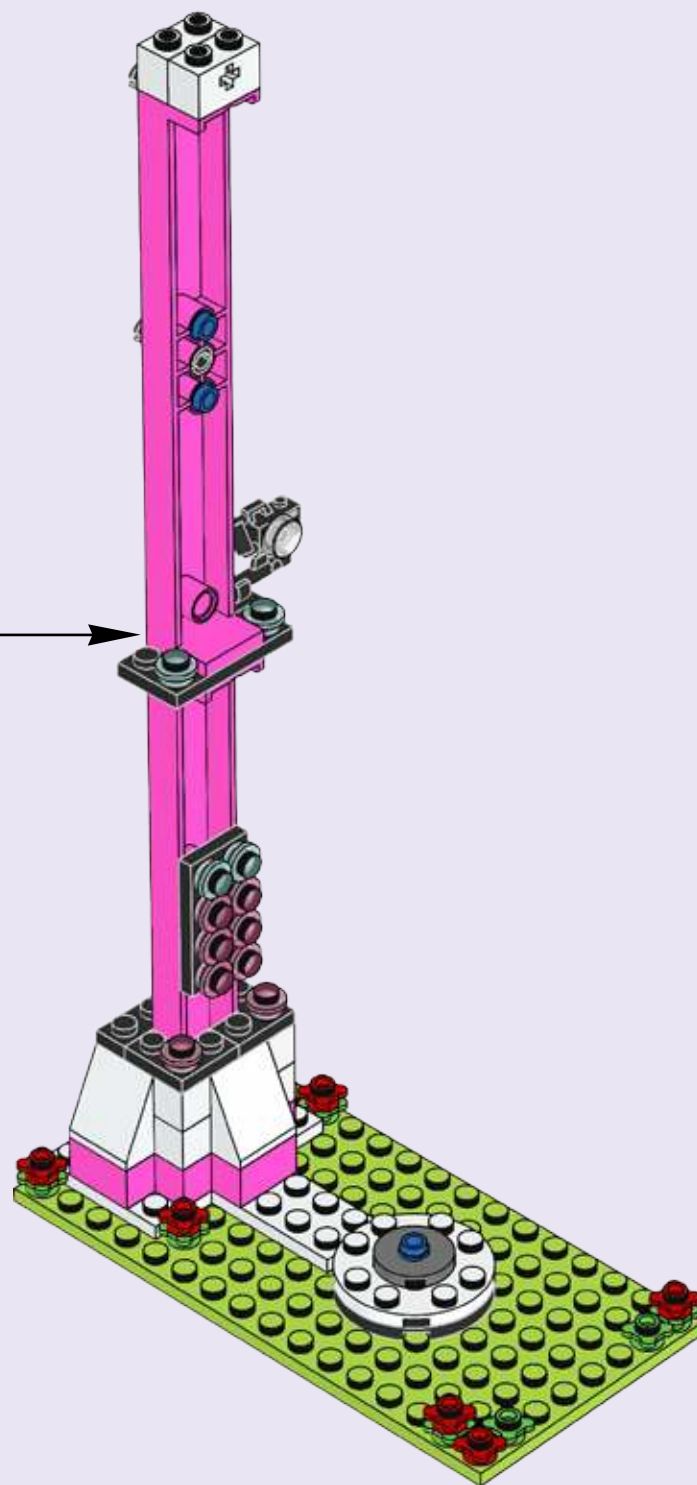
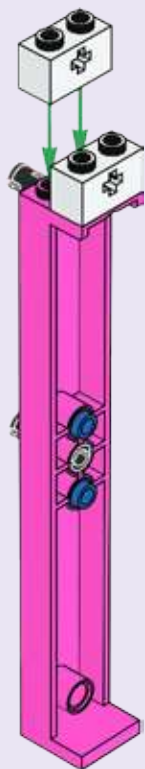

3

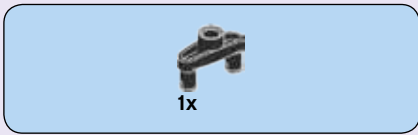



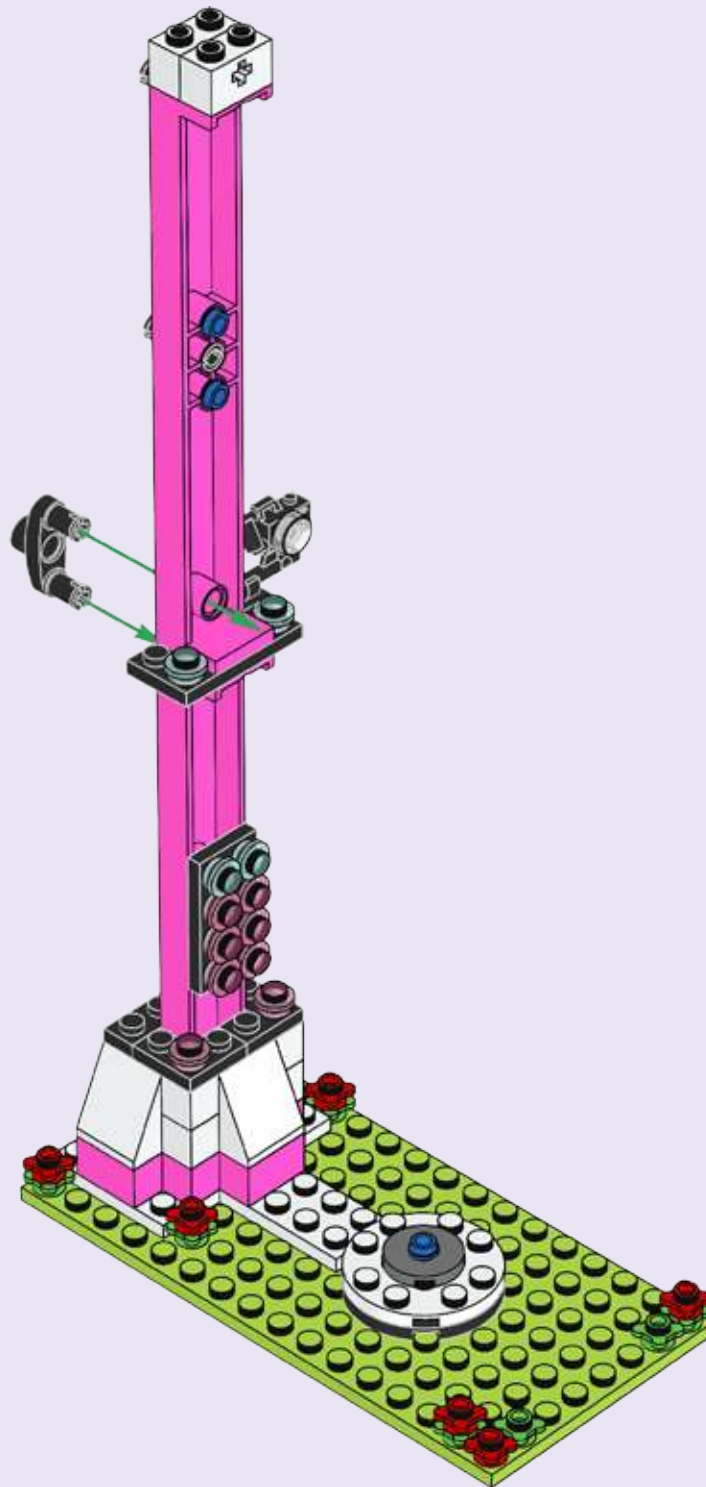

16

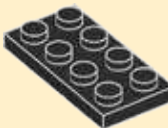

1x  6x  2x 

17

1  2 

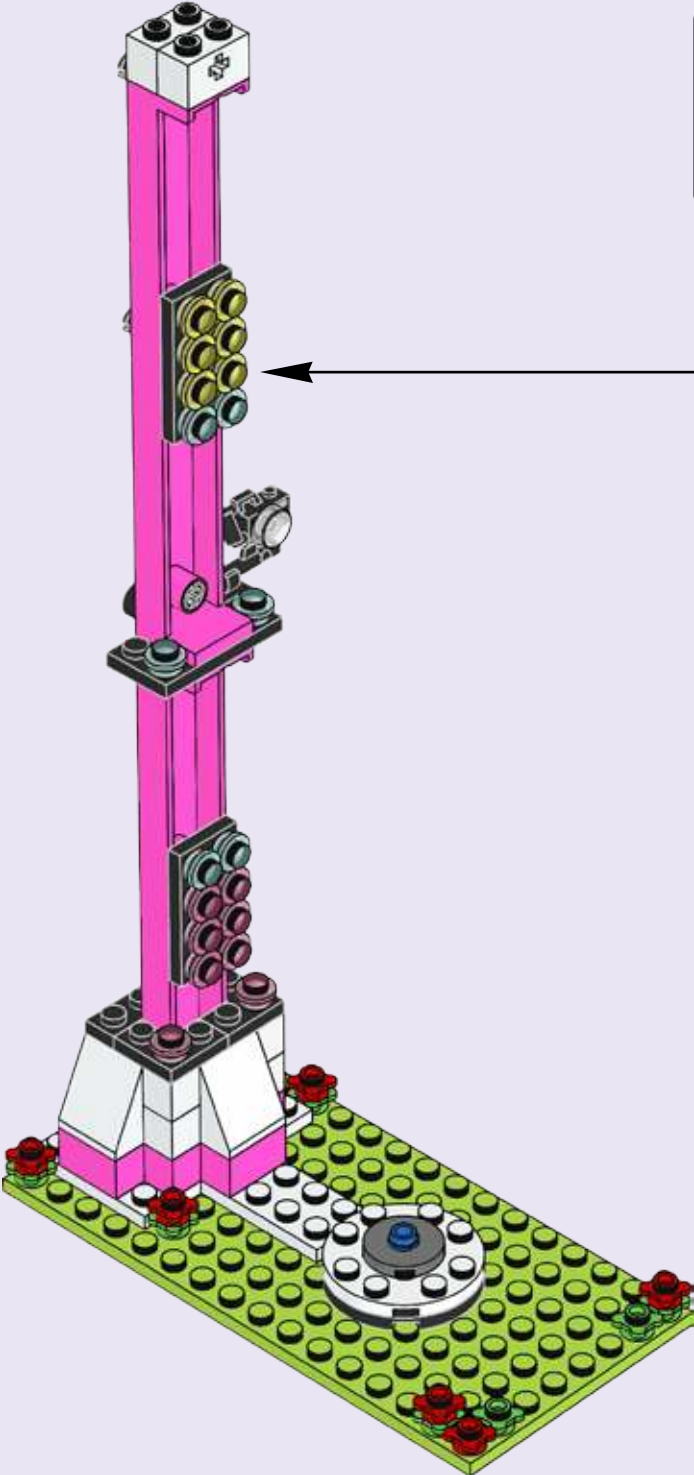

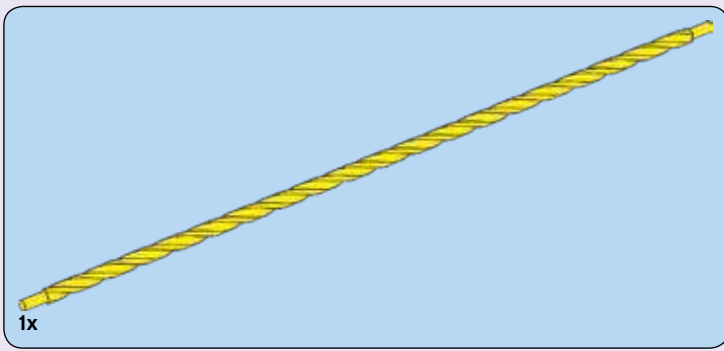

18

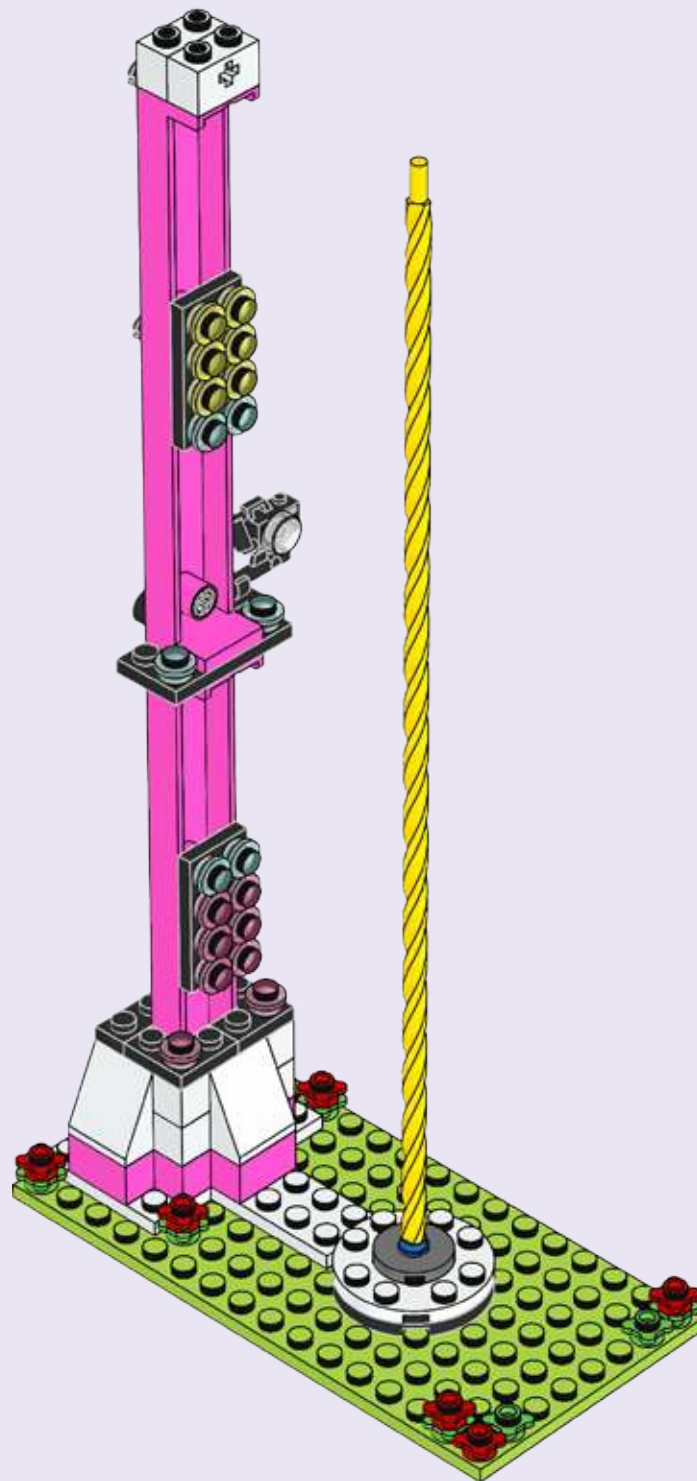

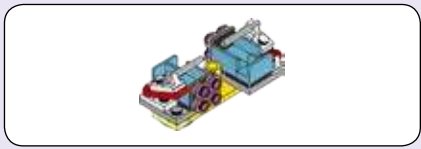

# 19

1

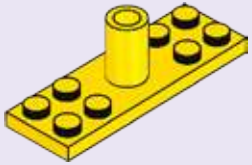

2

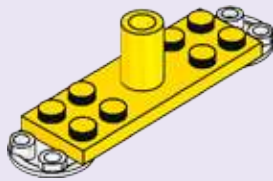

3

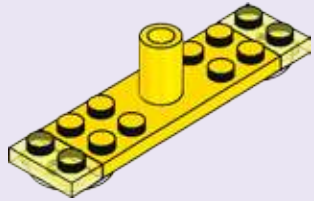

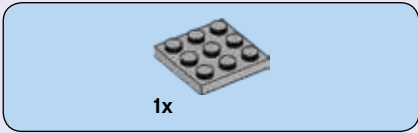

# 20

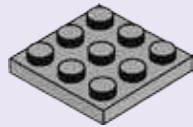

# 21



# 22

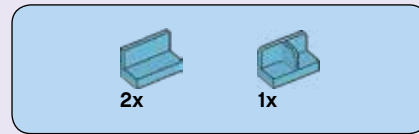
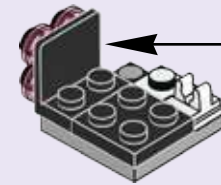
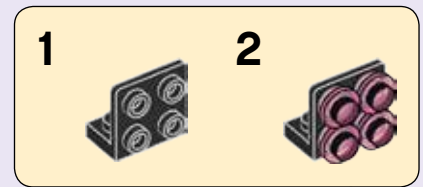

# 23

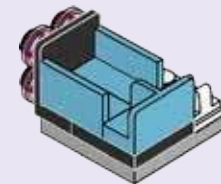



# 24

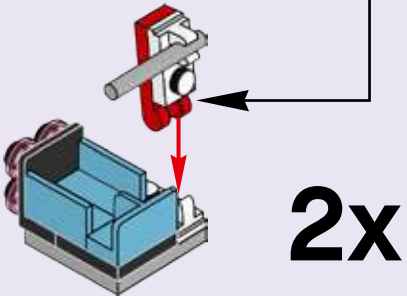
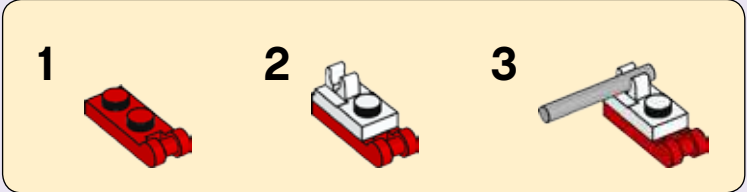

# 25

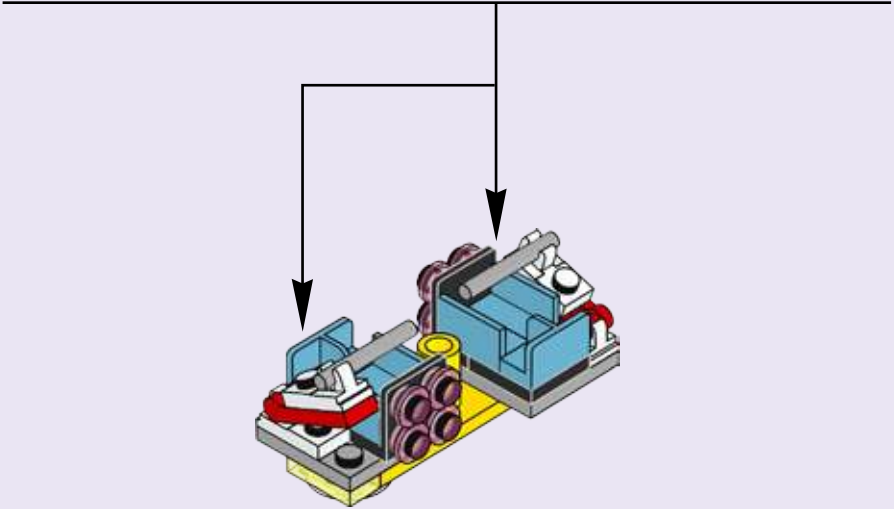
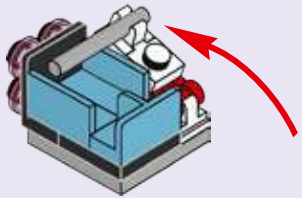



26

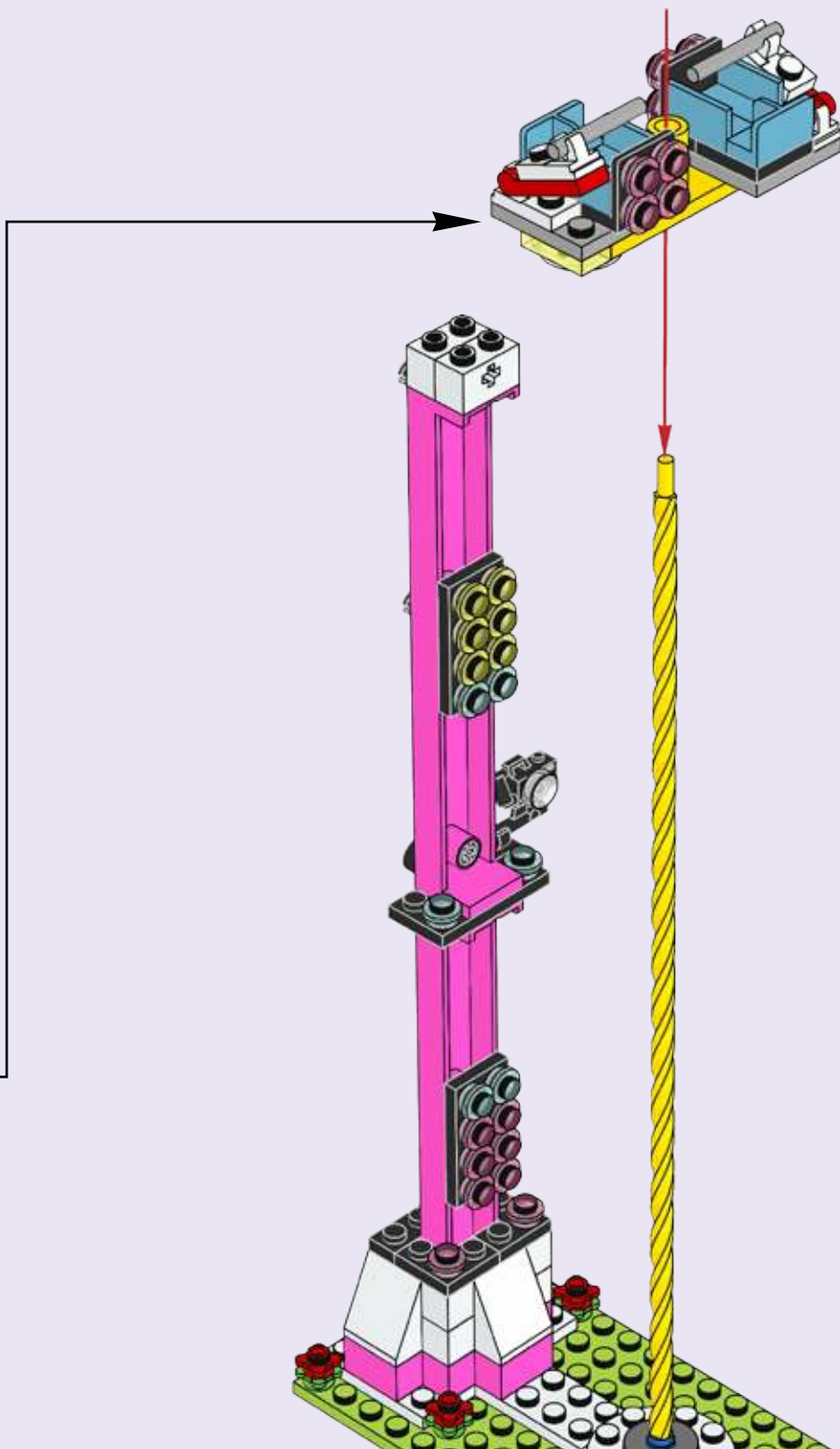

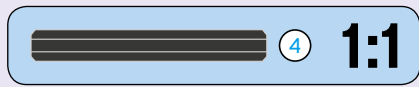
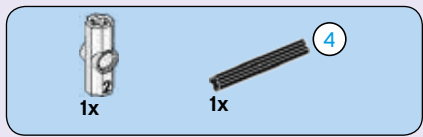

# 27

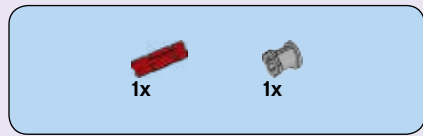
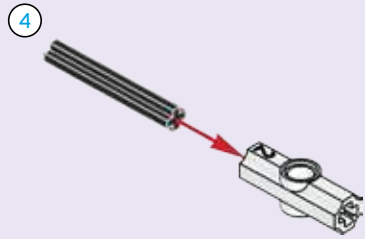

# 28

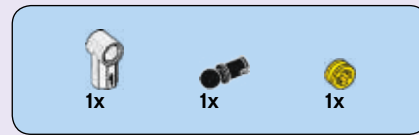
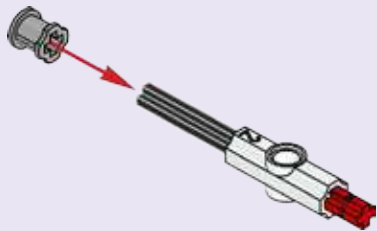

# 29

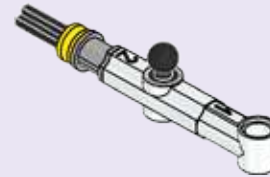

# 30

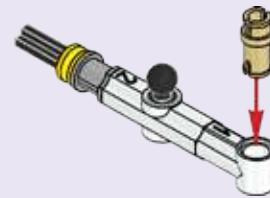

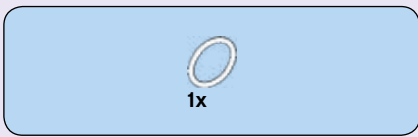

31

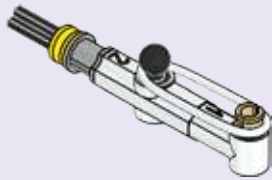

32

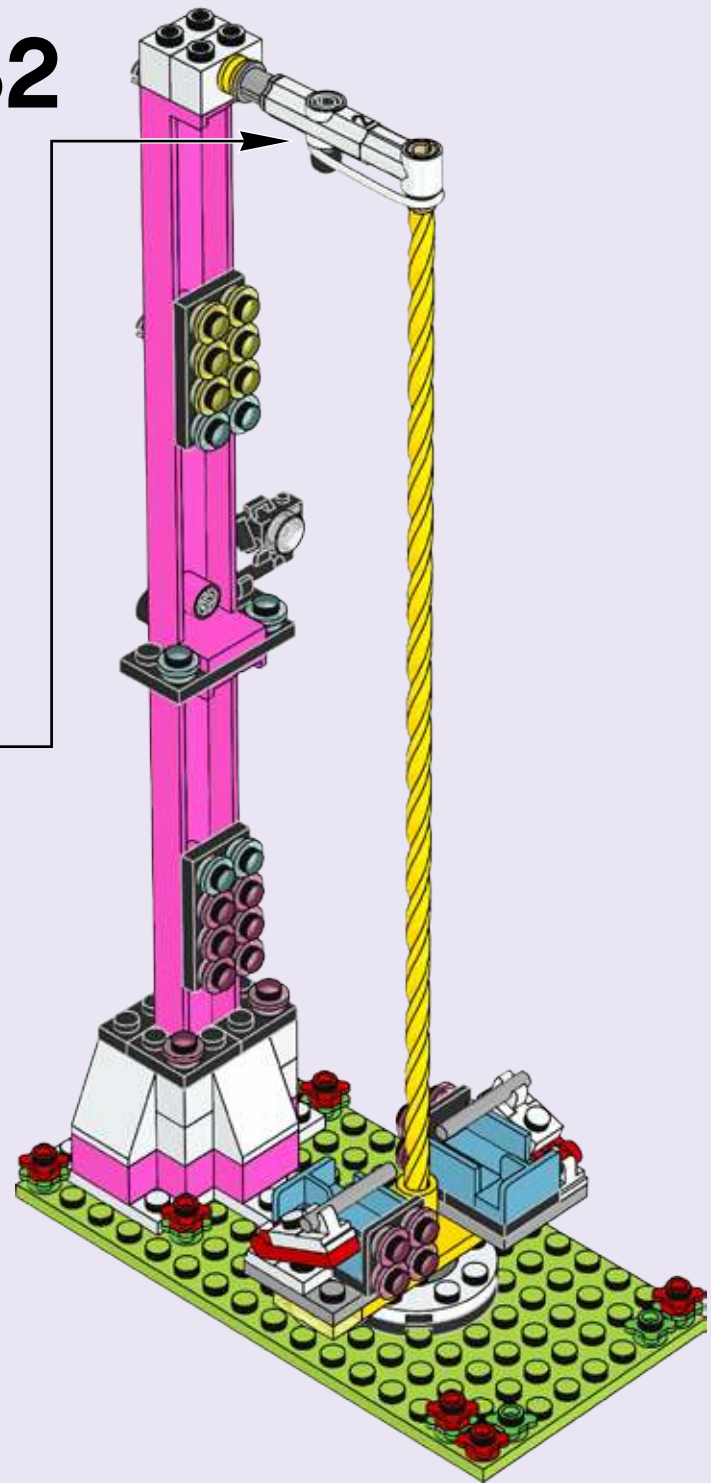

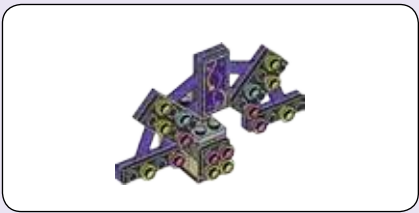

**33**

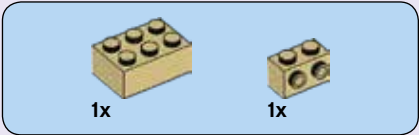
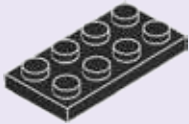

**34**

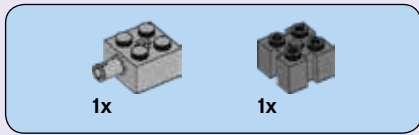
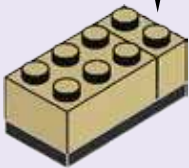
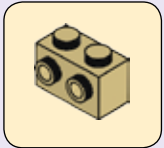

**35**

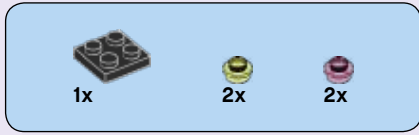
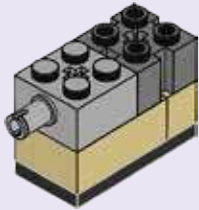

**36**

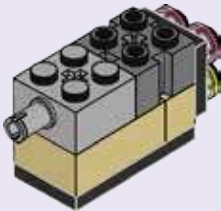
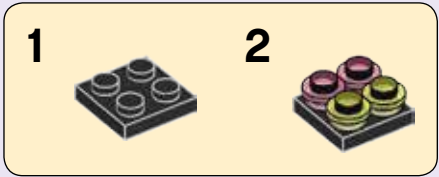

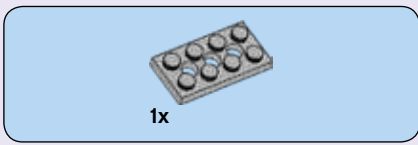

# 37

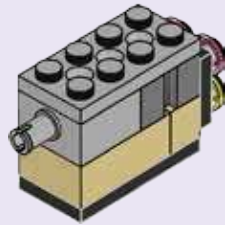

# 38

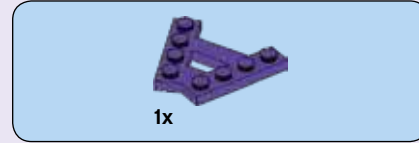
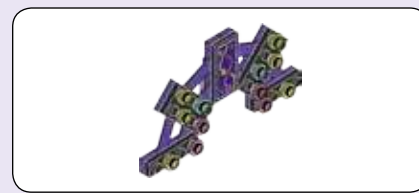
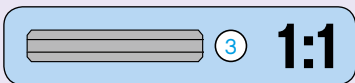
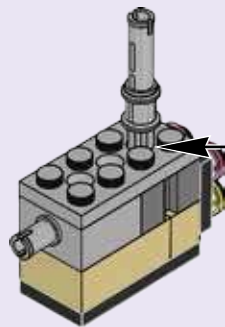
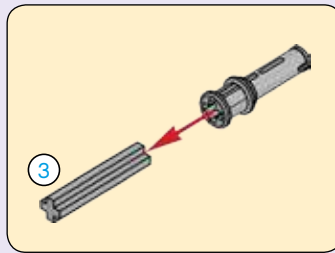

# 39

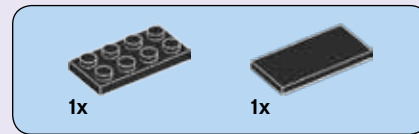
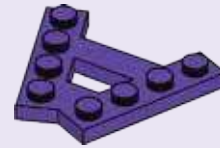

# 40



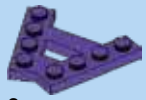

2x

# 41

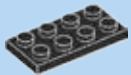

1x

# 42

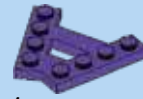

1x

# 43

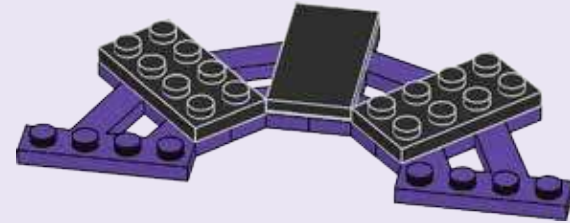

2x

# 44

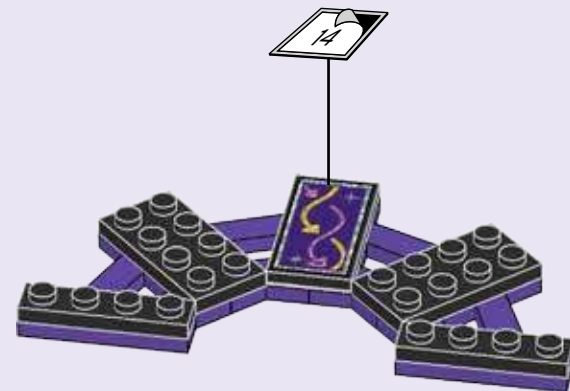

6x 2x 4x

45



1x

46

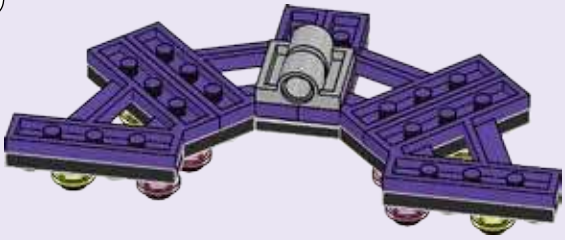

47

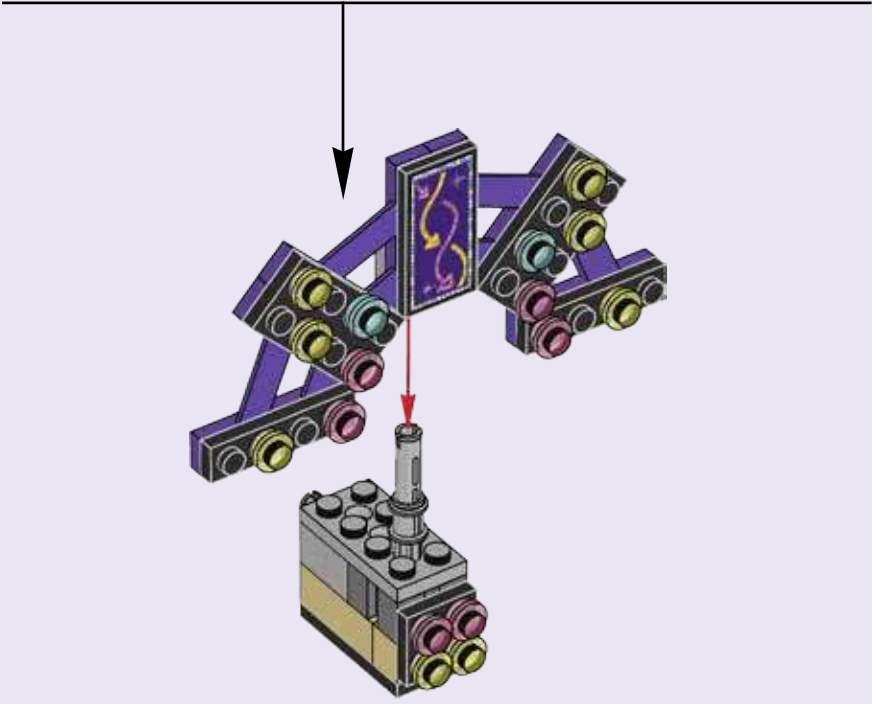

48

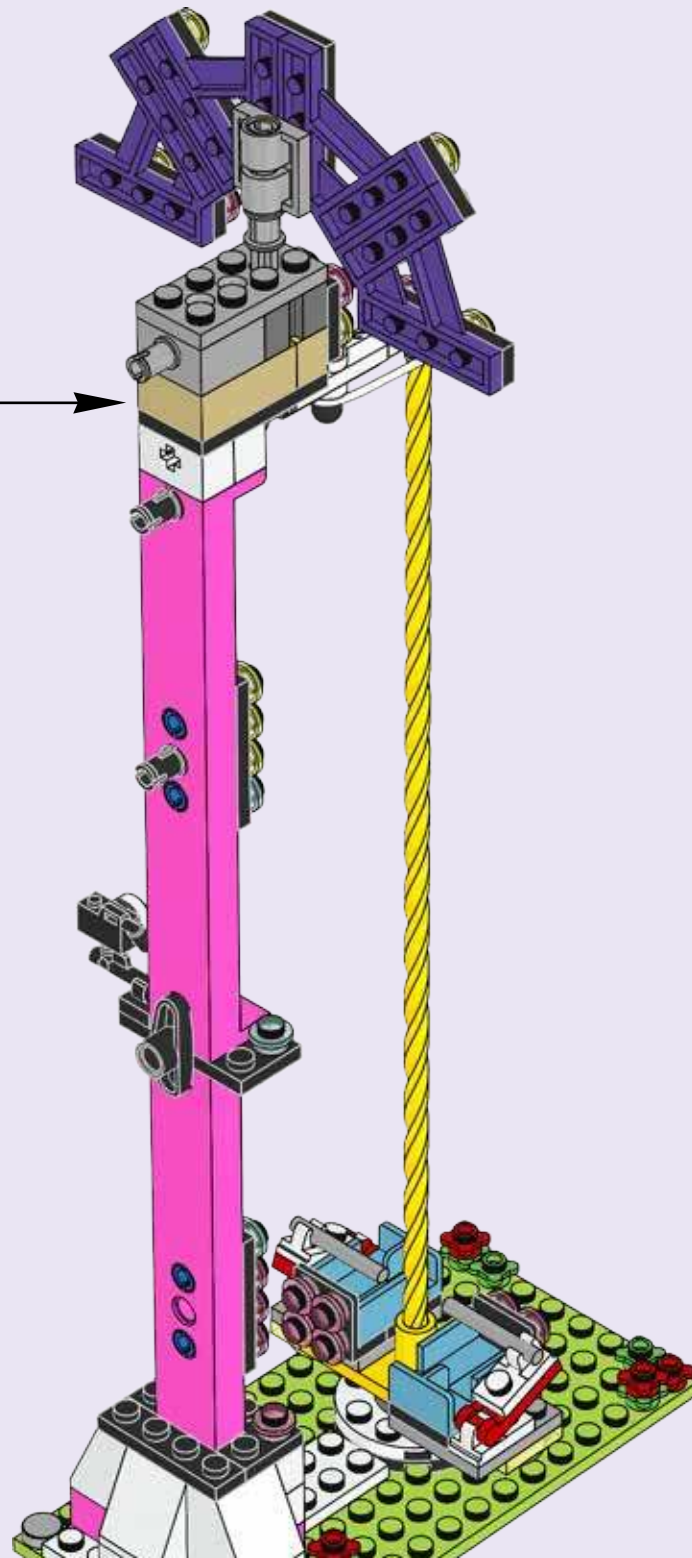



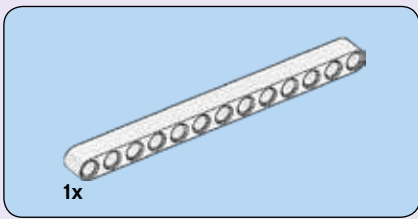

49

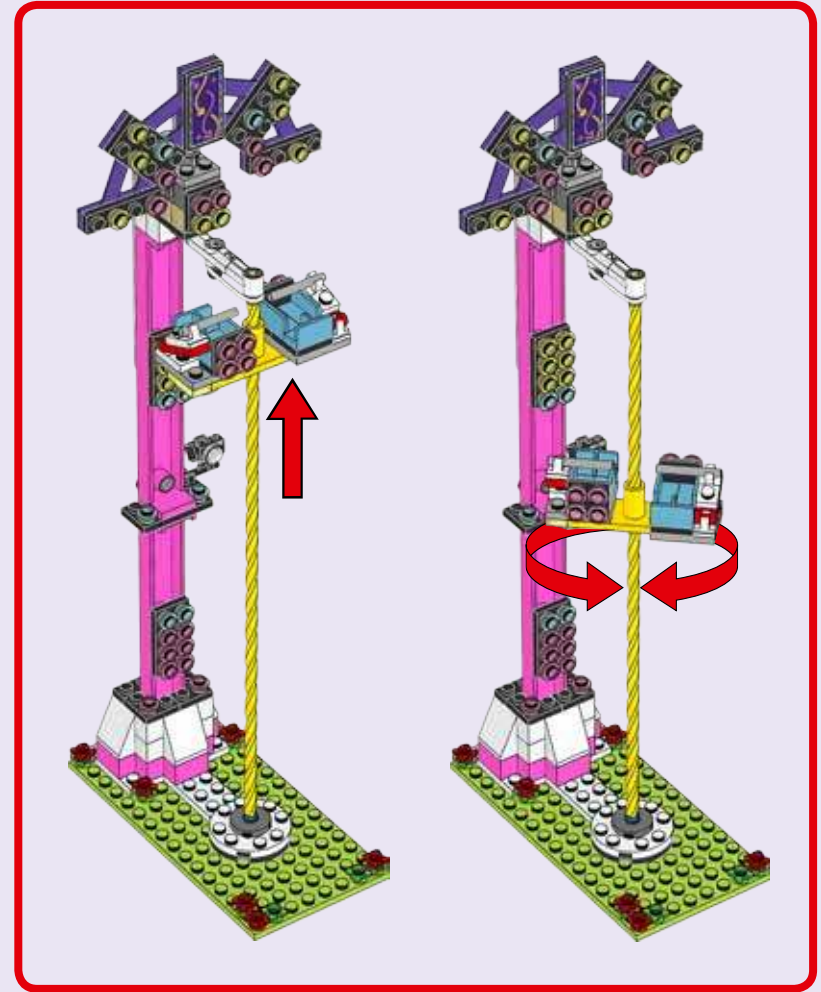
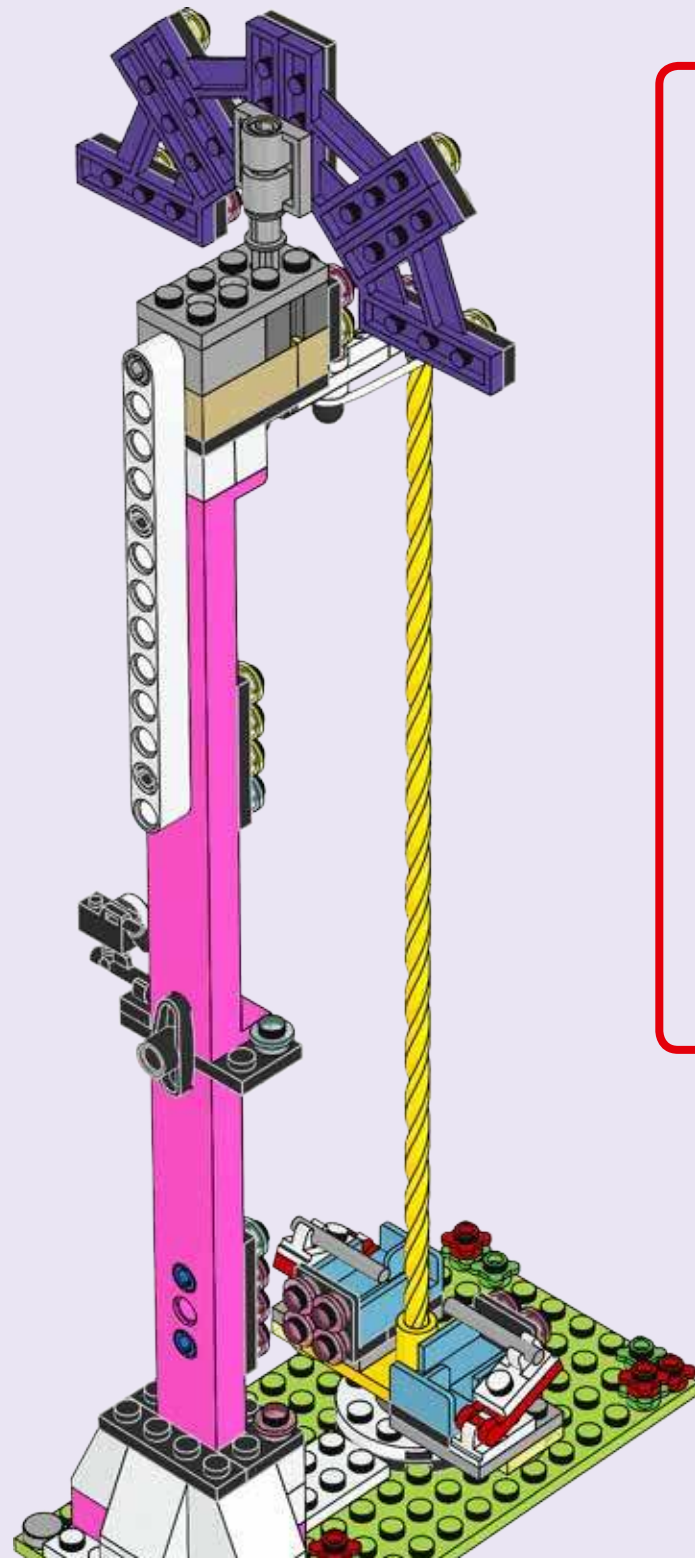

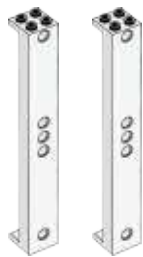
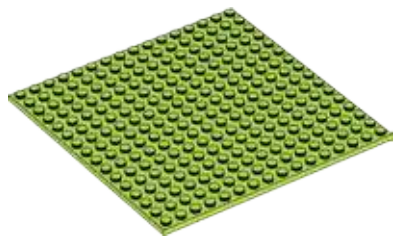

+

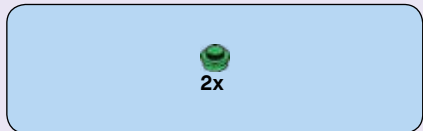
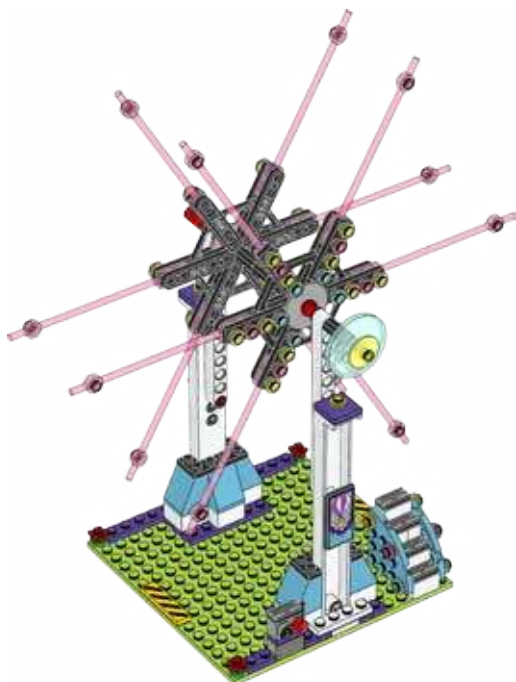

1

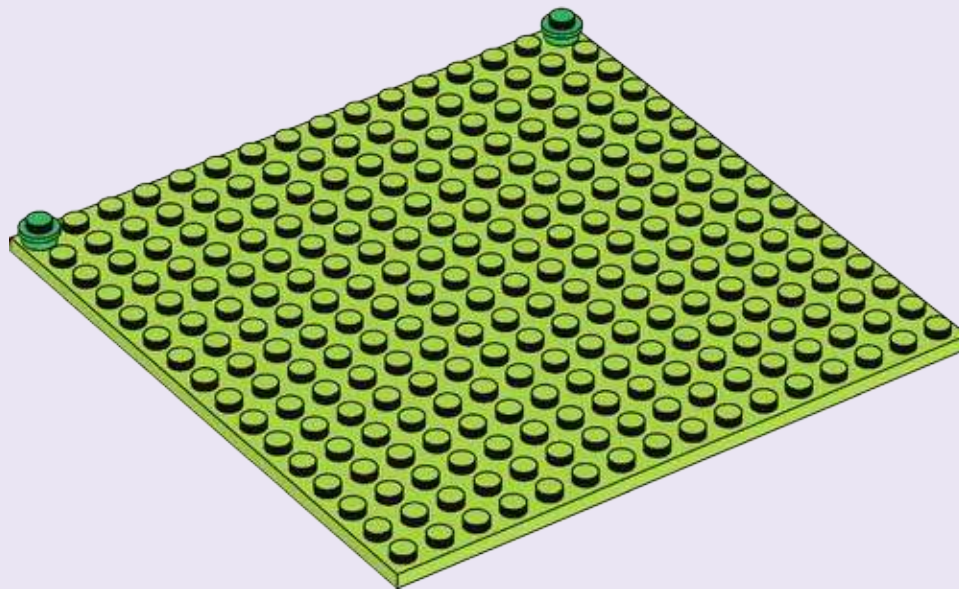

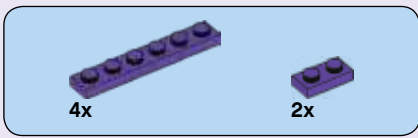

2

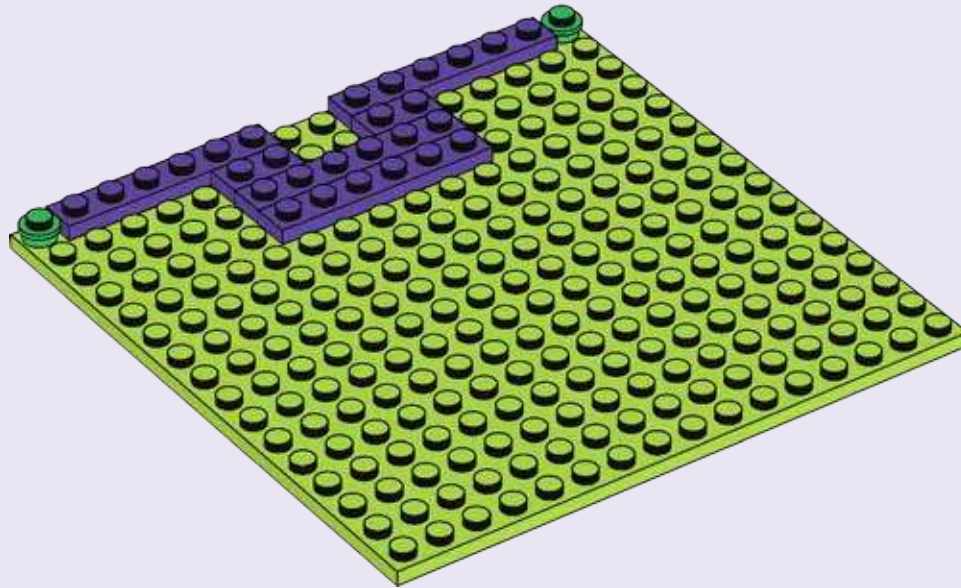

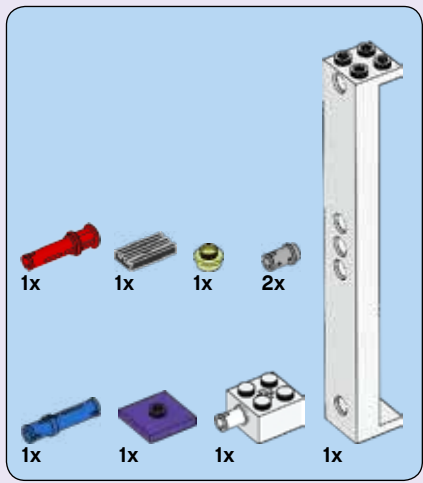

**3**

**1**

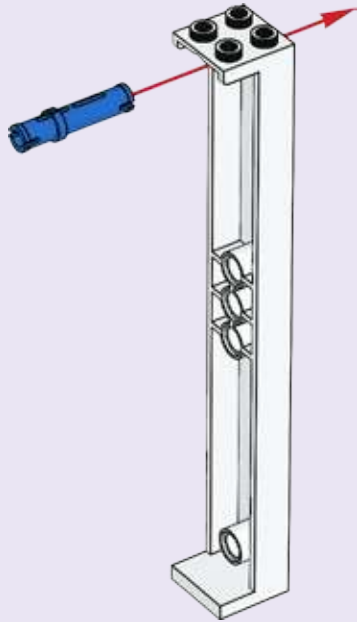

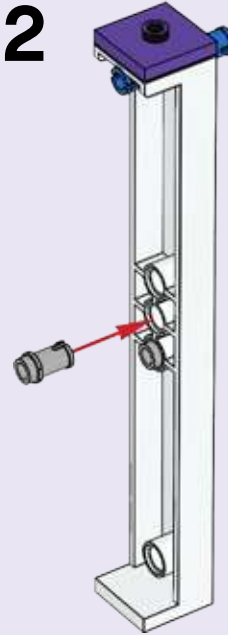

**2**

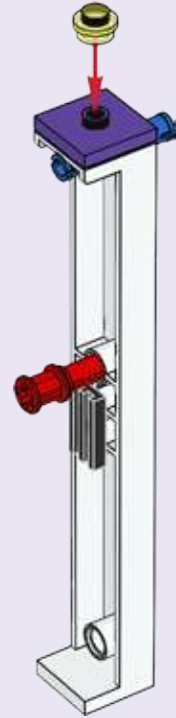

**3**

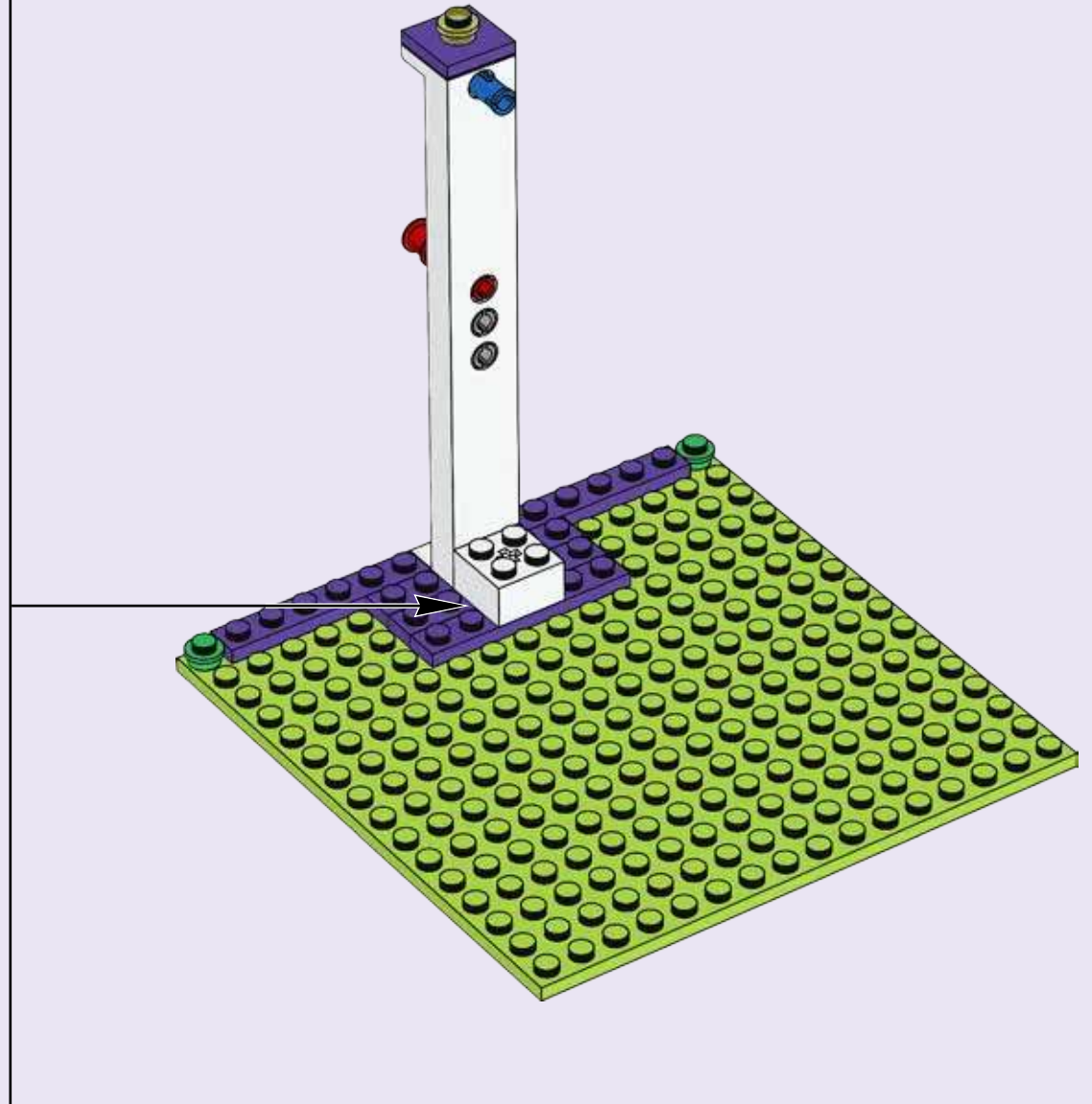
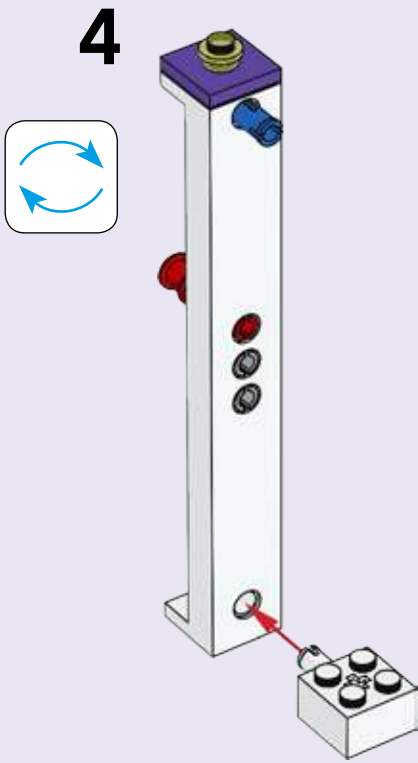



1x  2x 

4

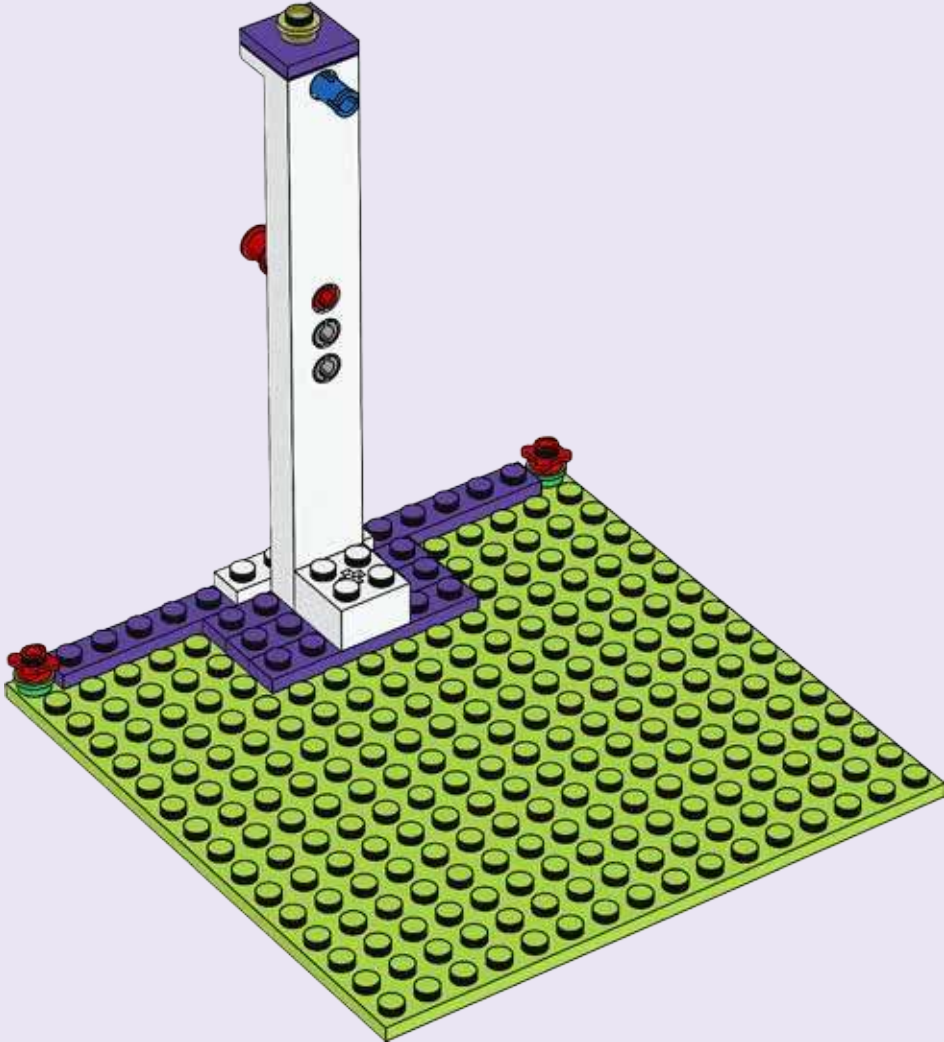

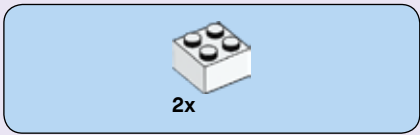

5

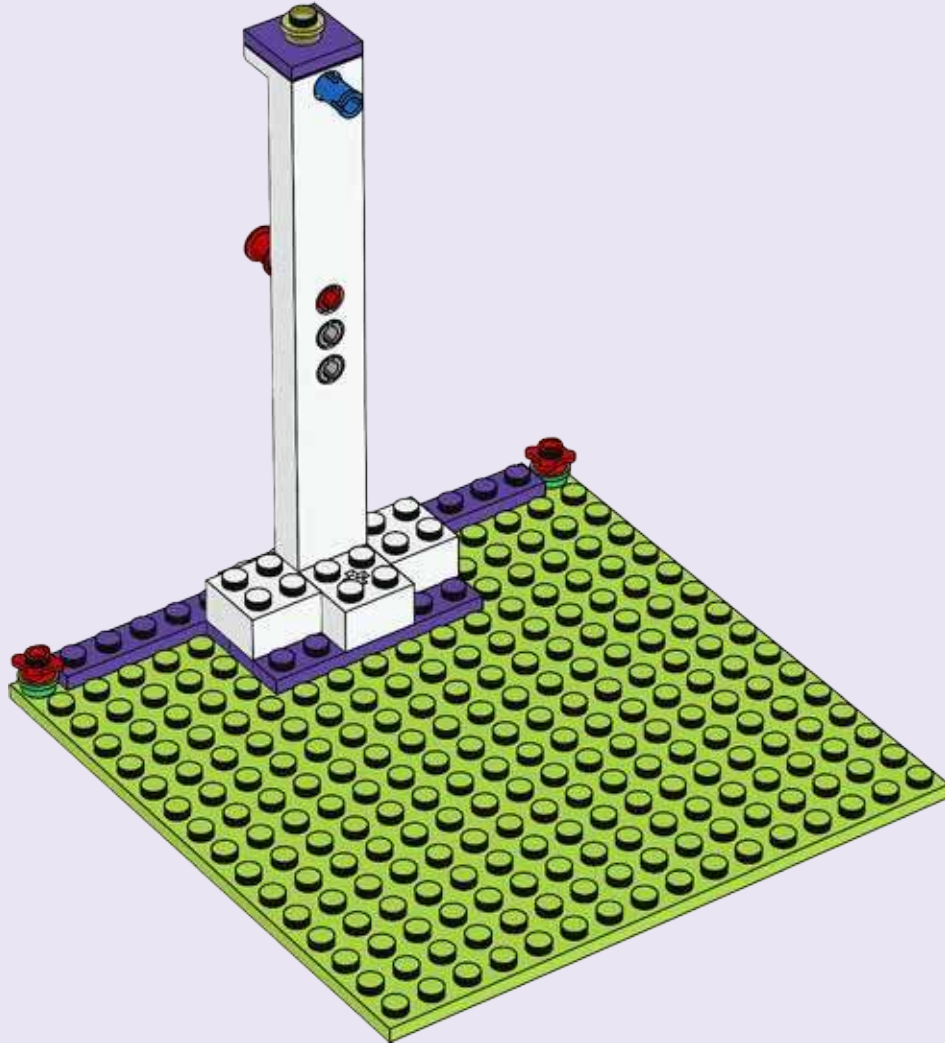

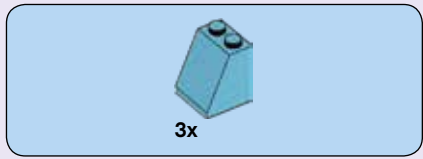

6

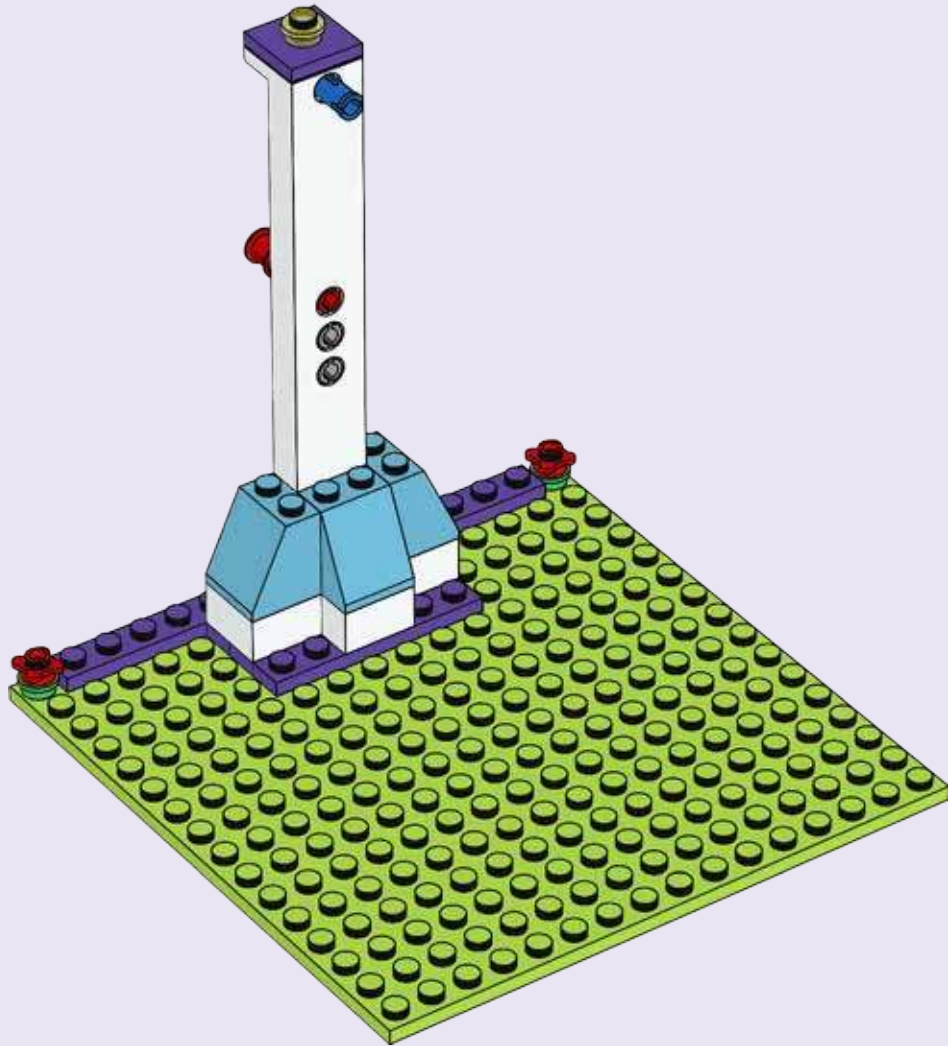





7

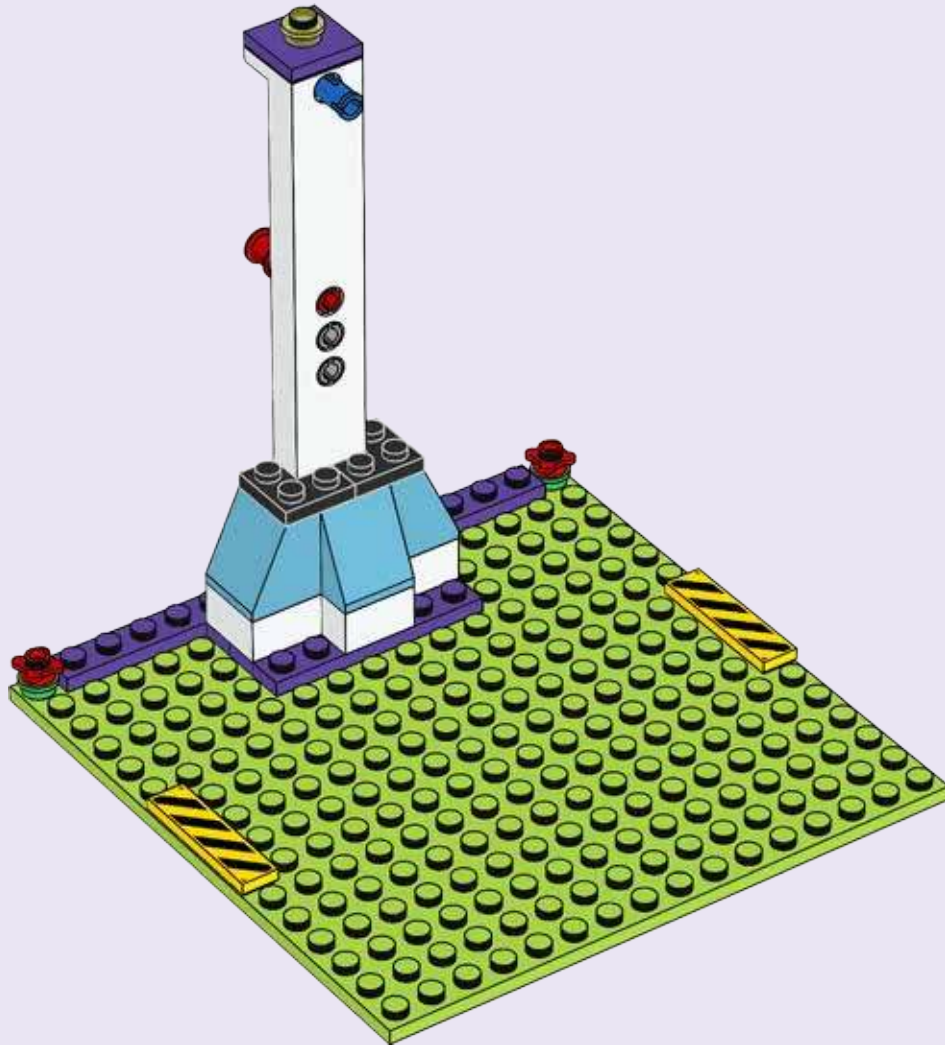



8

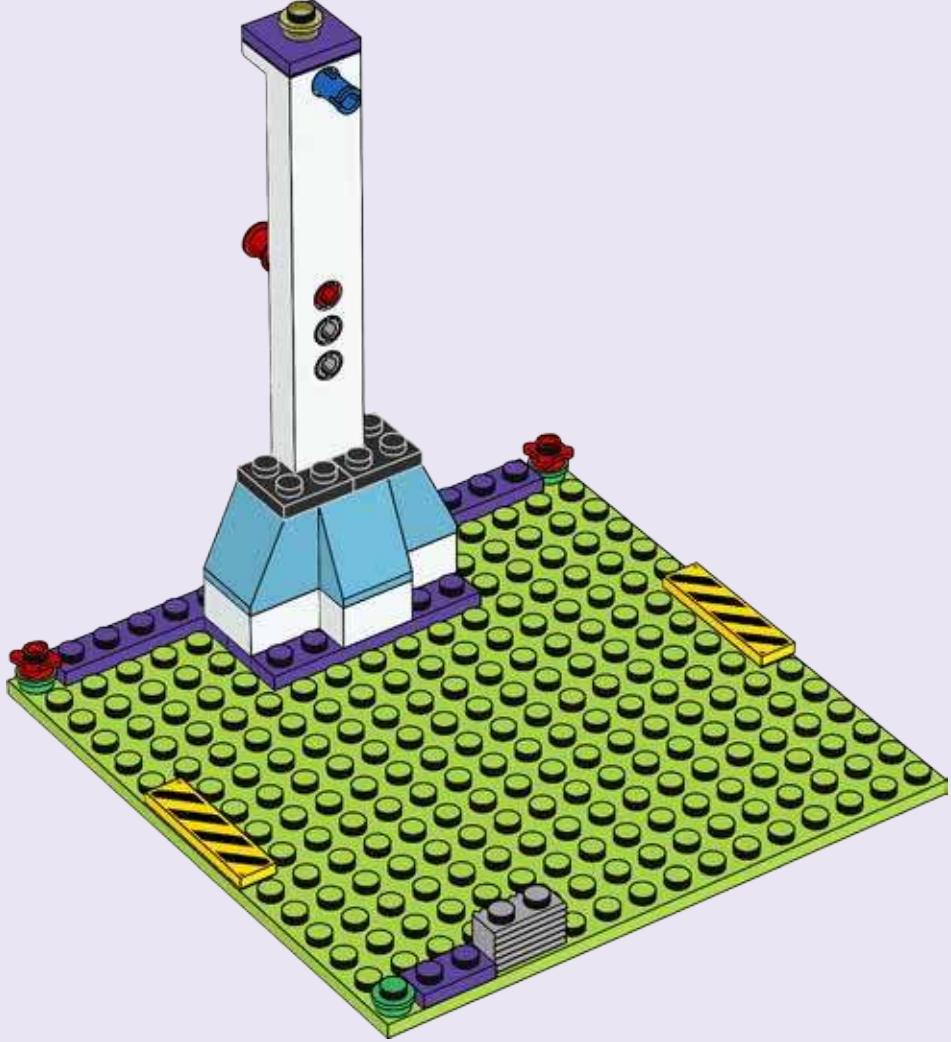

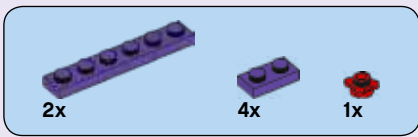

9

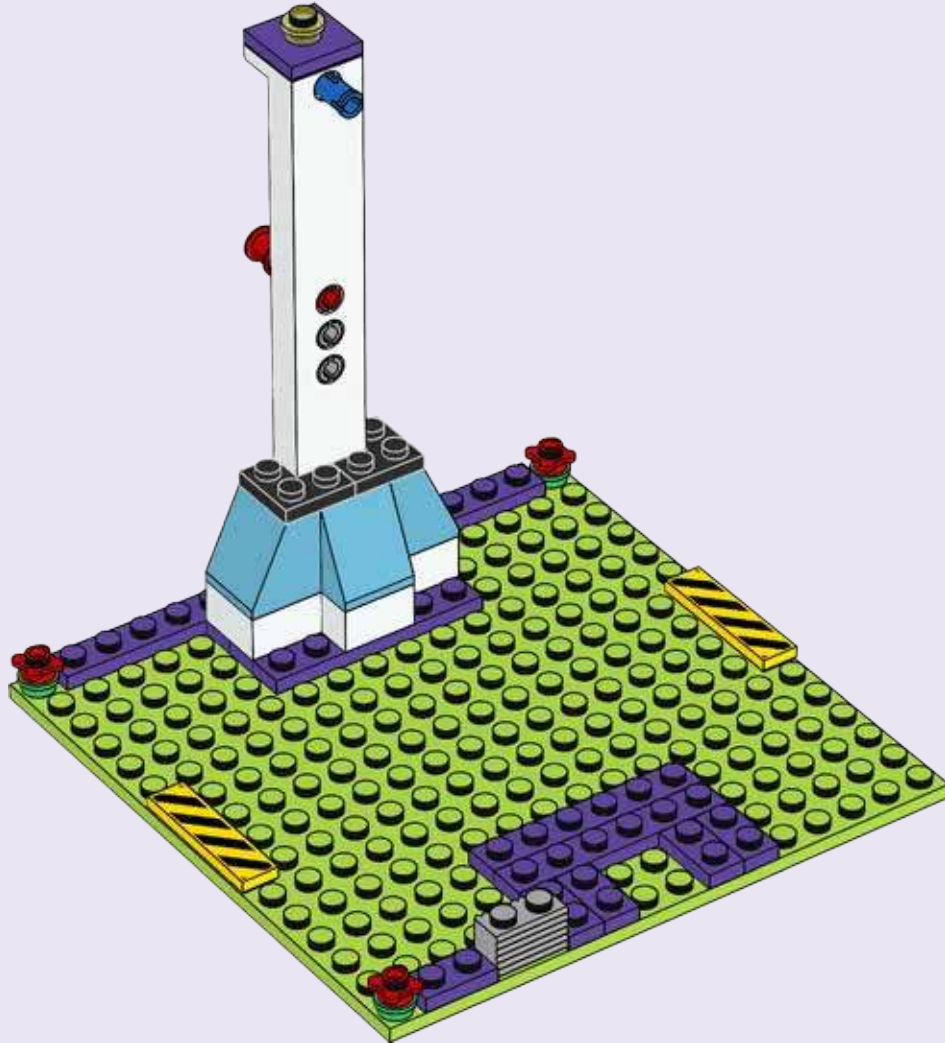

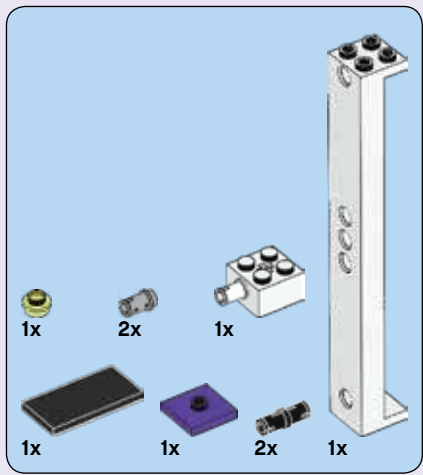

# 10

1

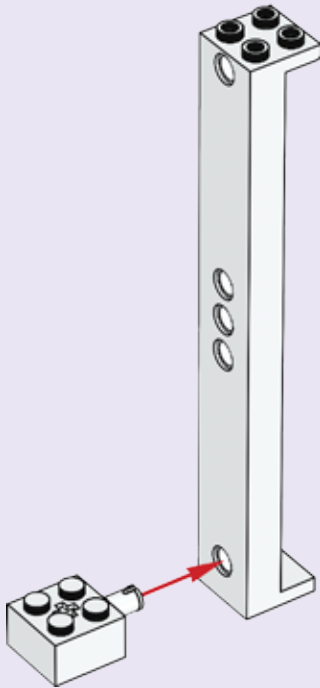

2



3

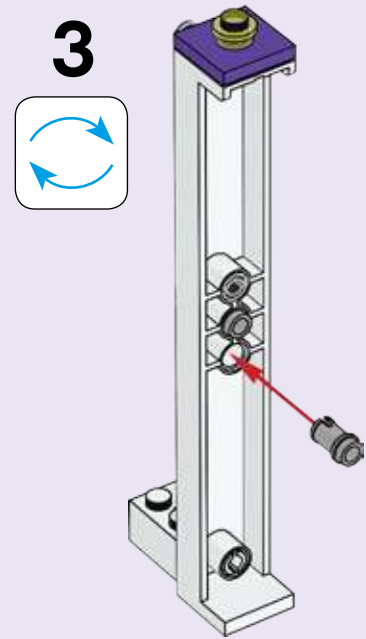

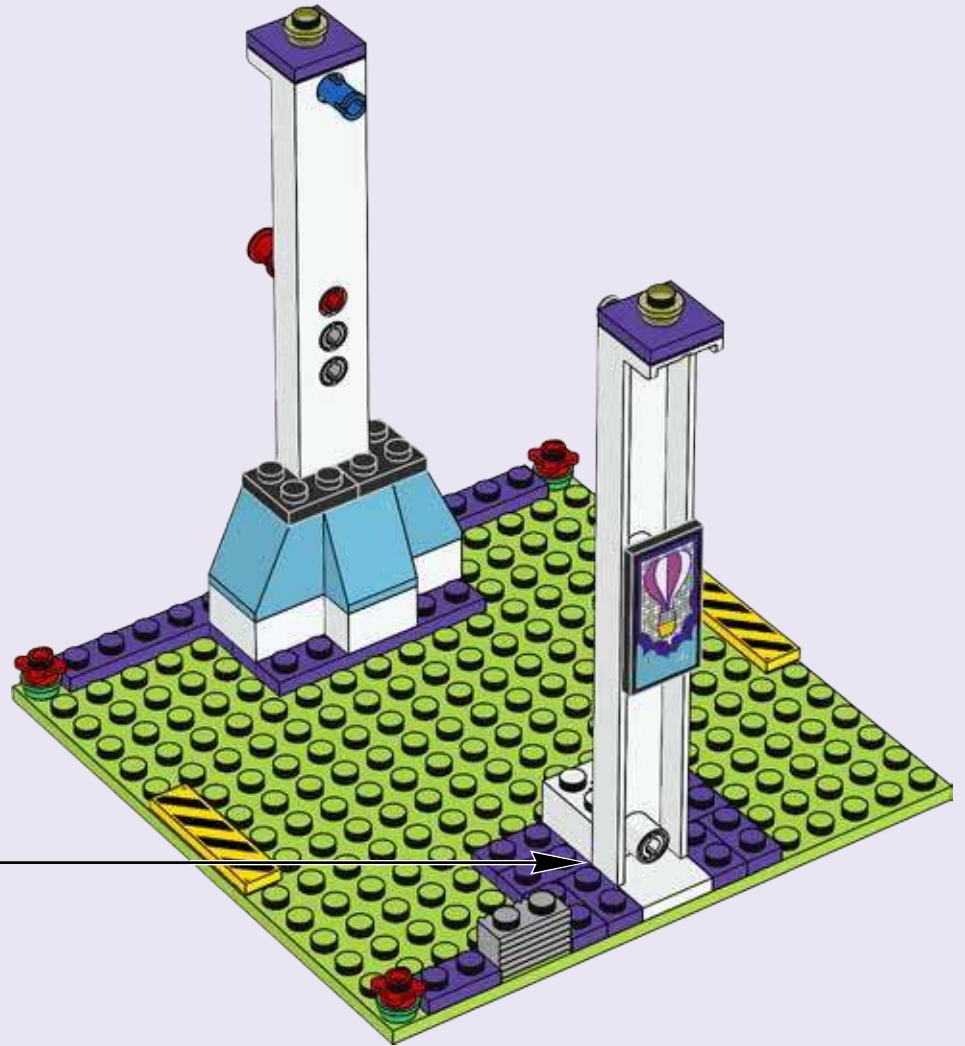
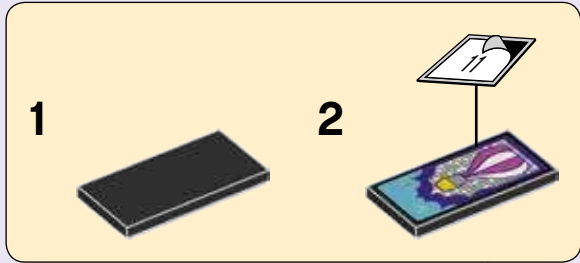

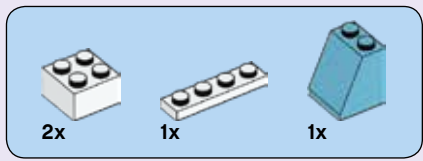

11

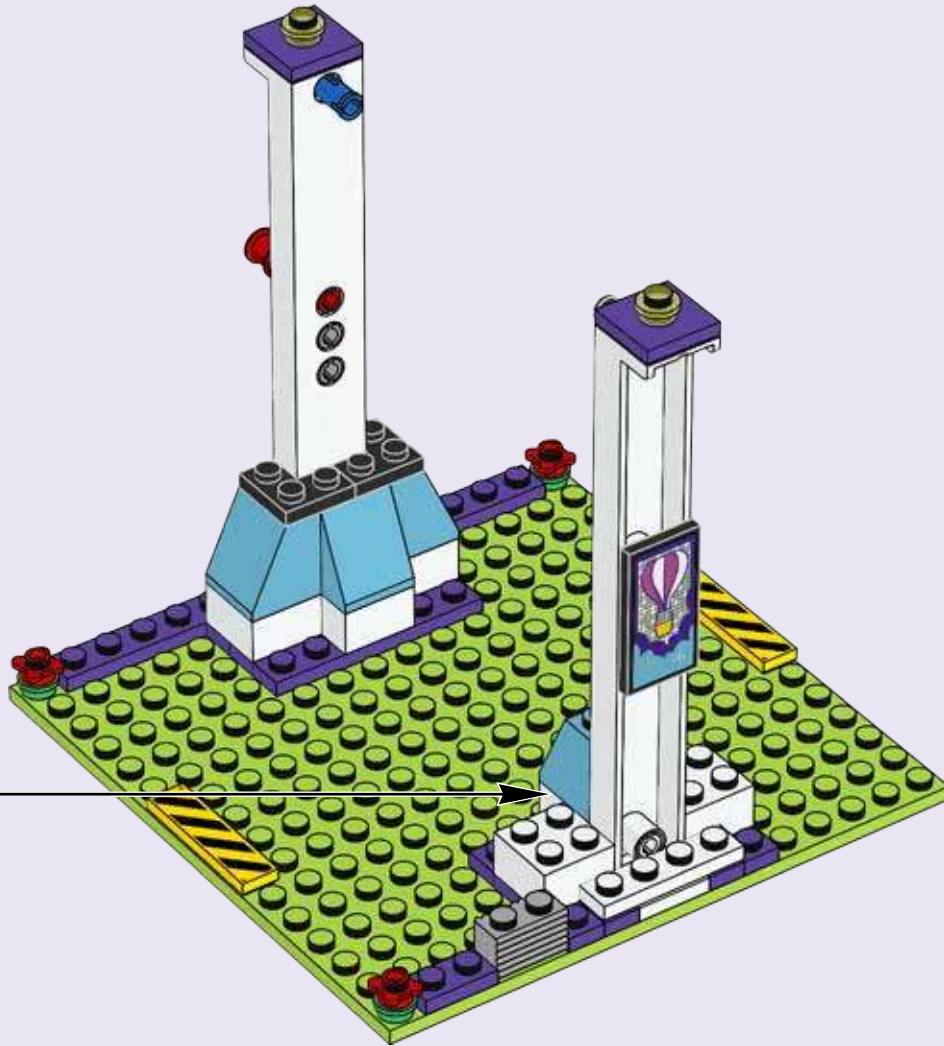
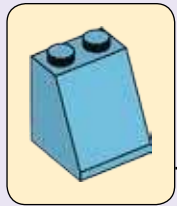



12

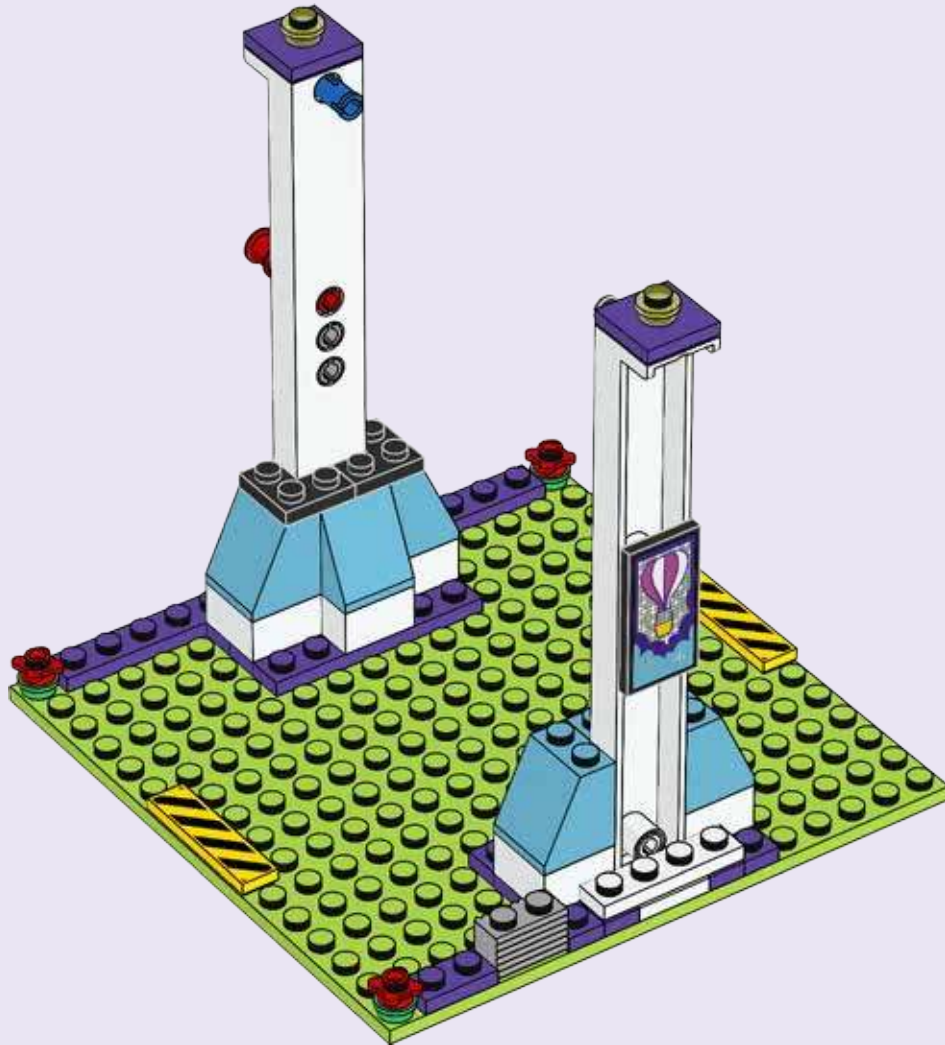



2x

# 13

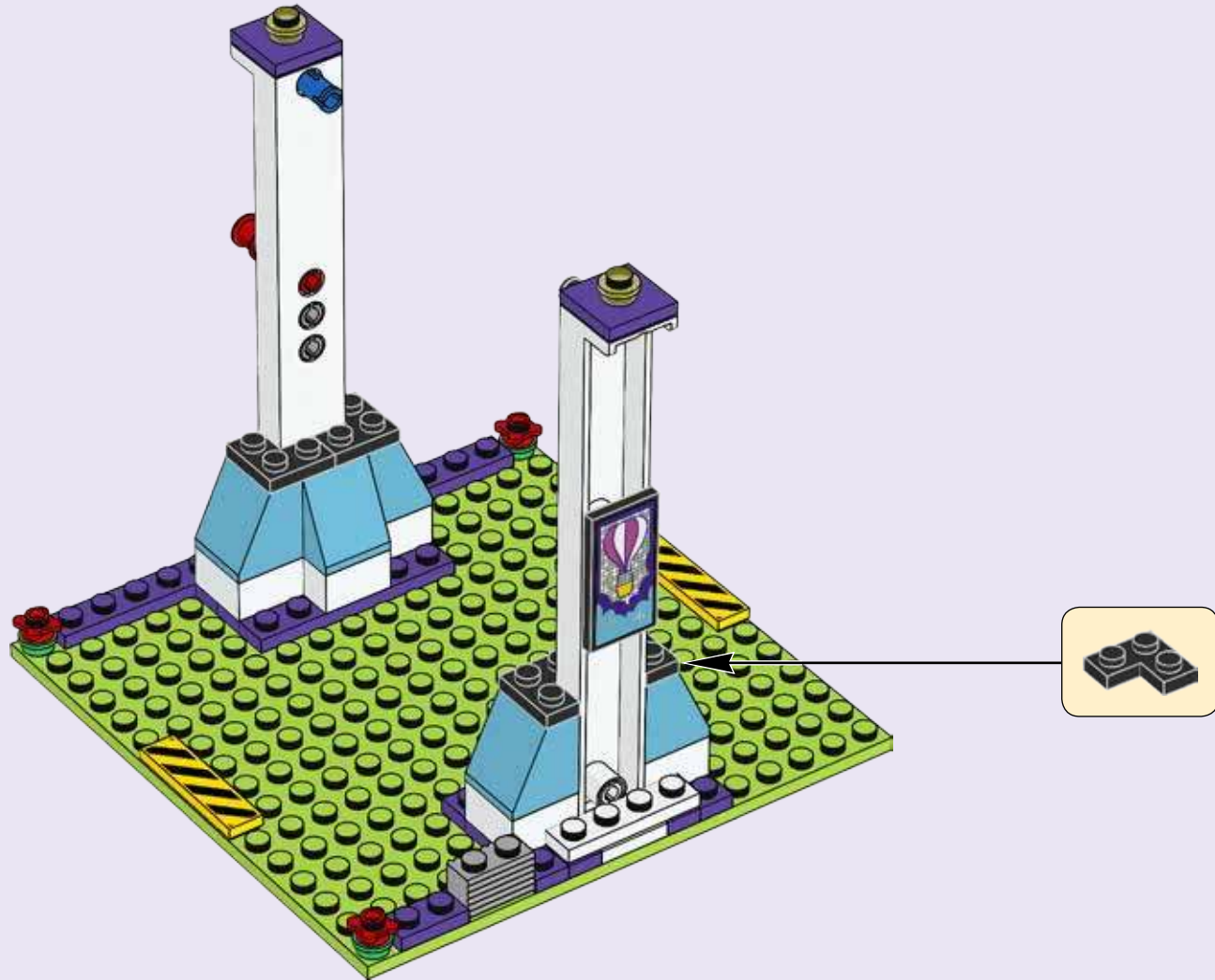



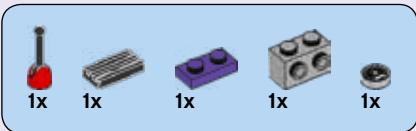

# 14

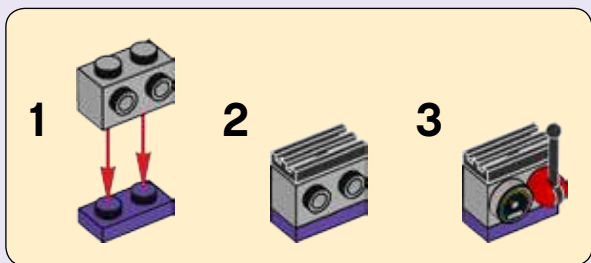
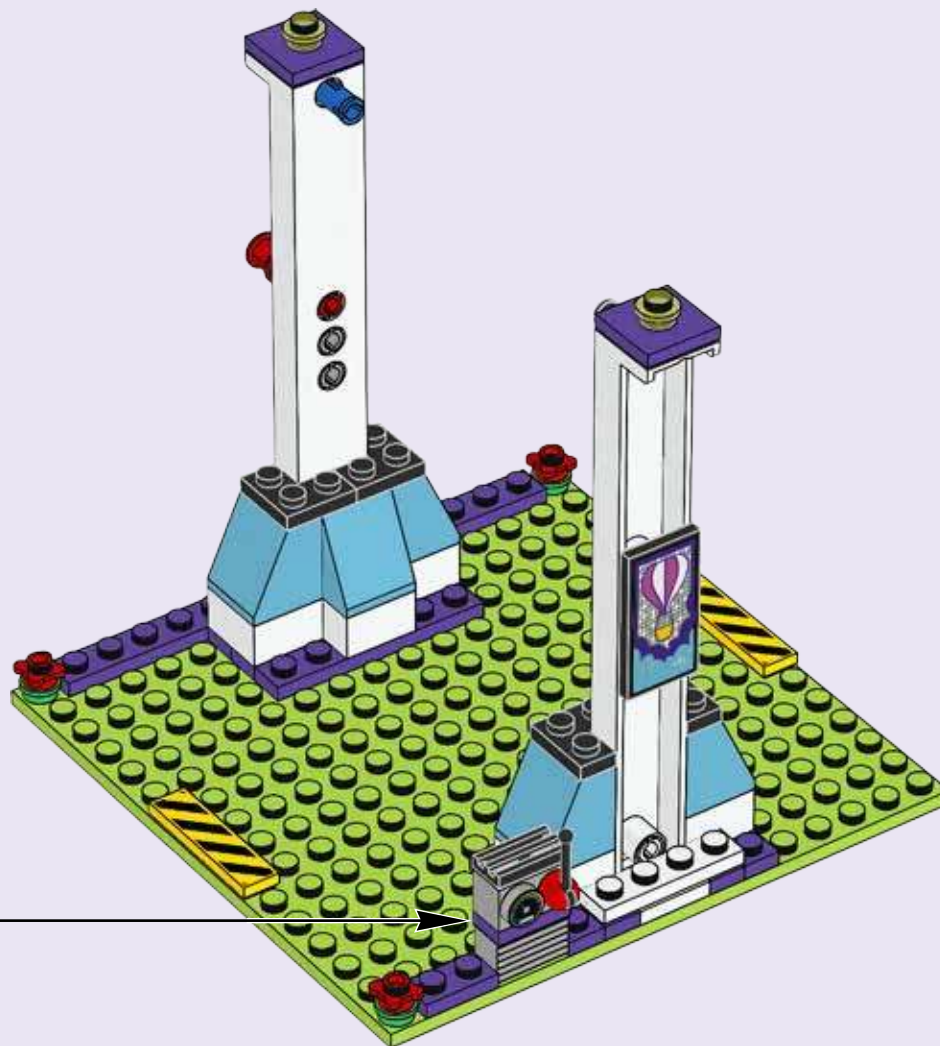

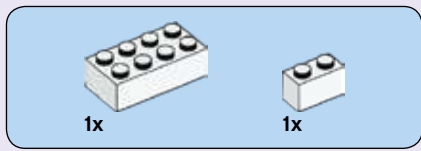

15

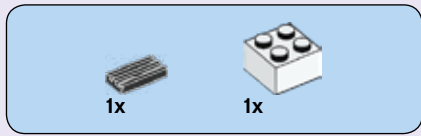
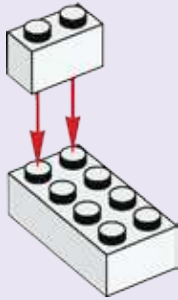

16

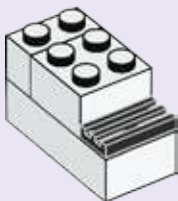

17

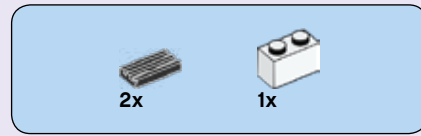
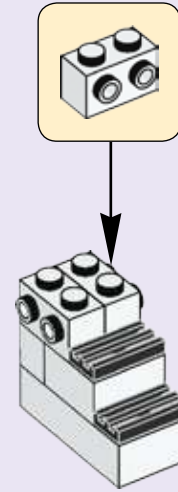

18

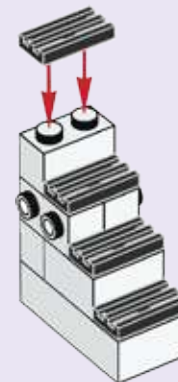

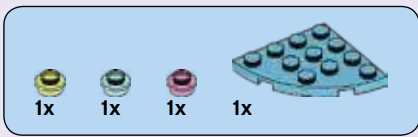

19

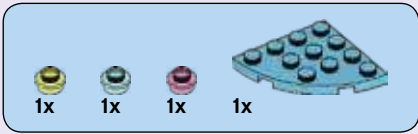
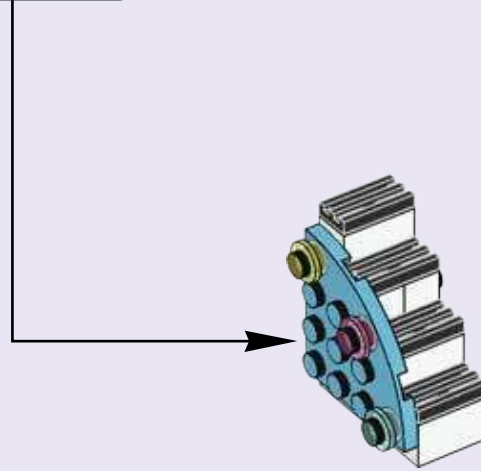
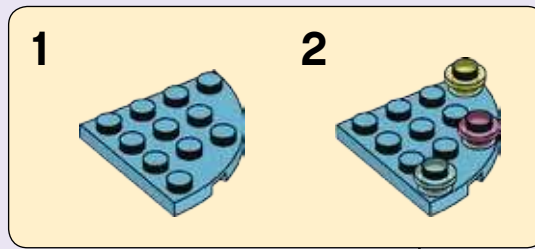

20

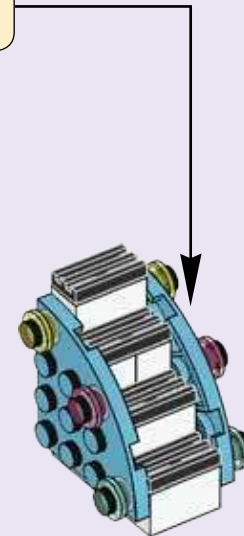

21

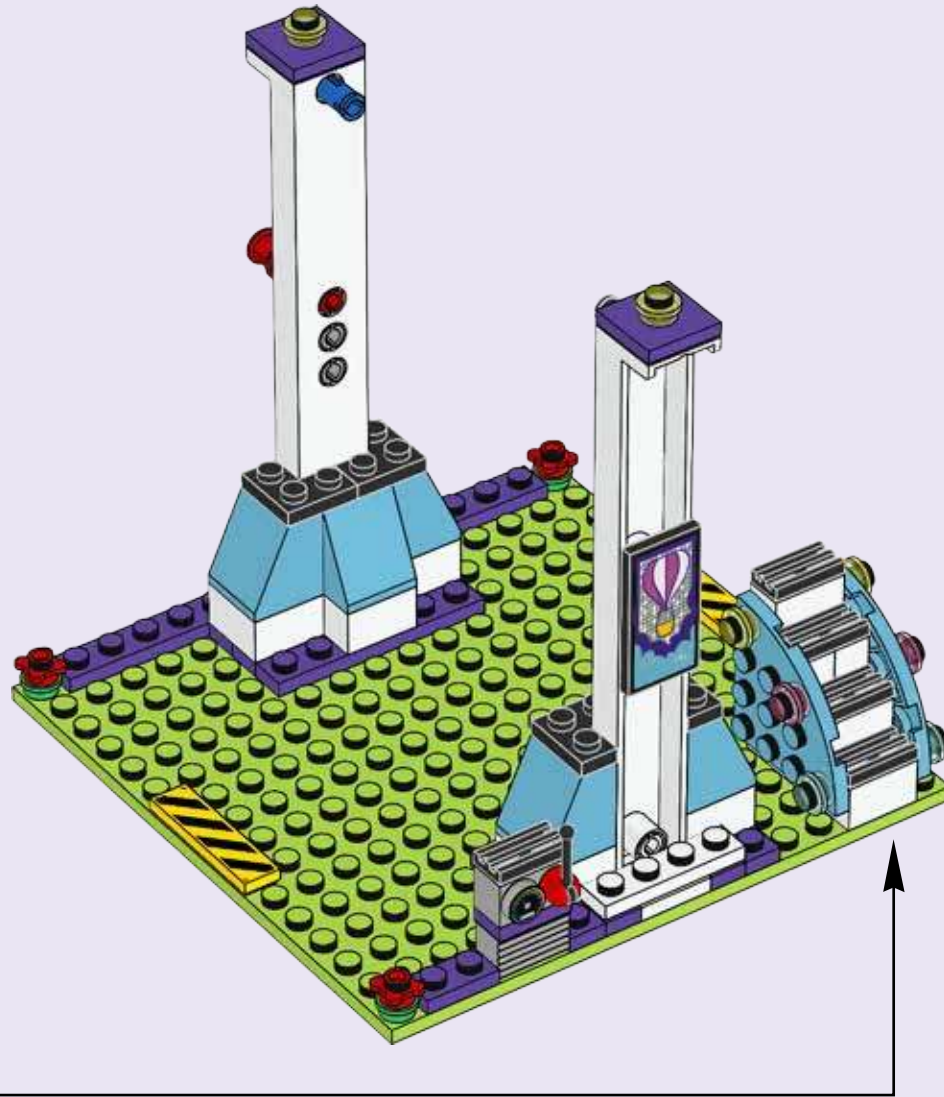

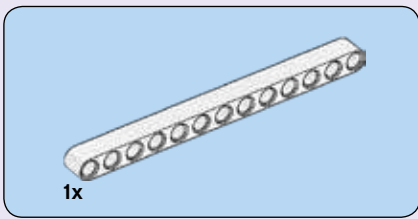

22

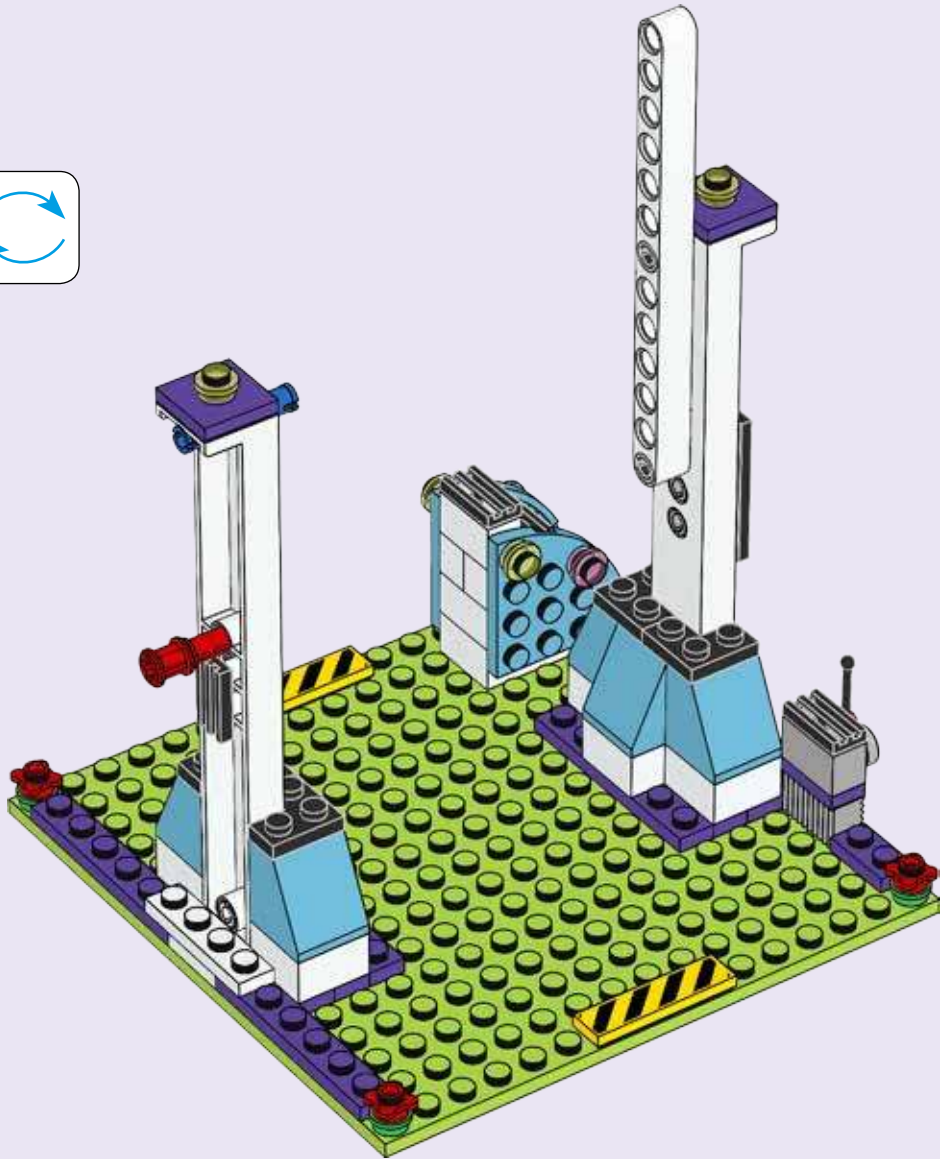
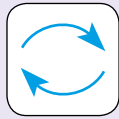

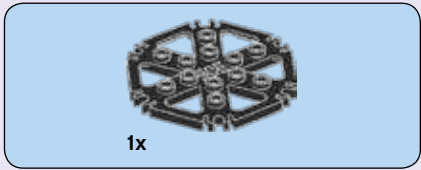
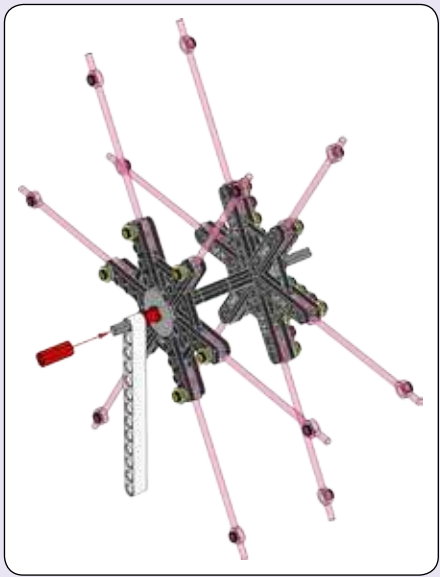

23

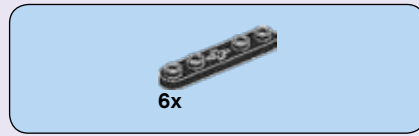

24

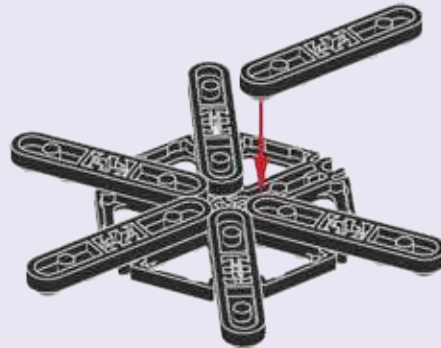

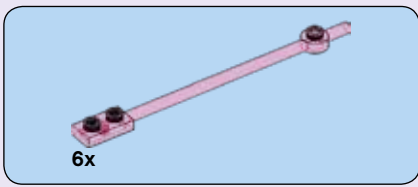

25

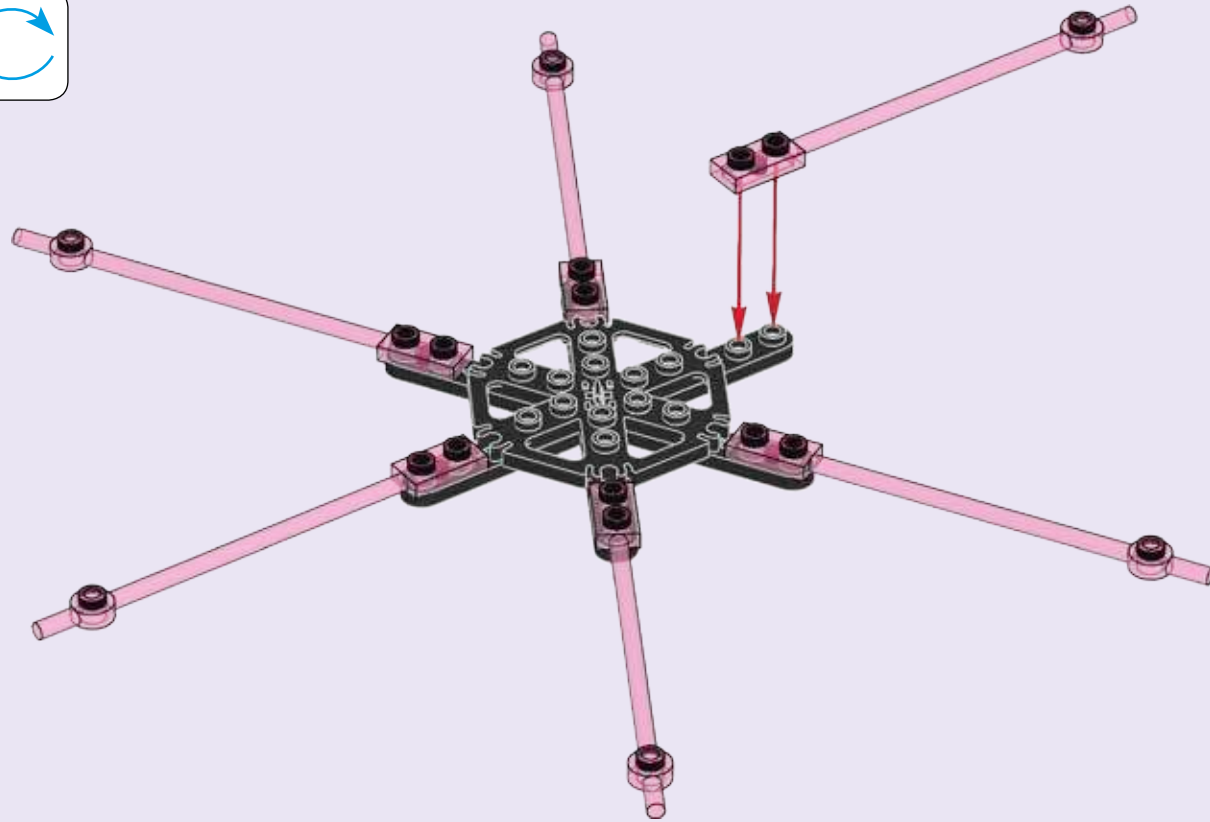
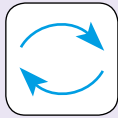



26

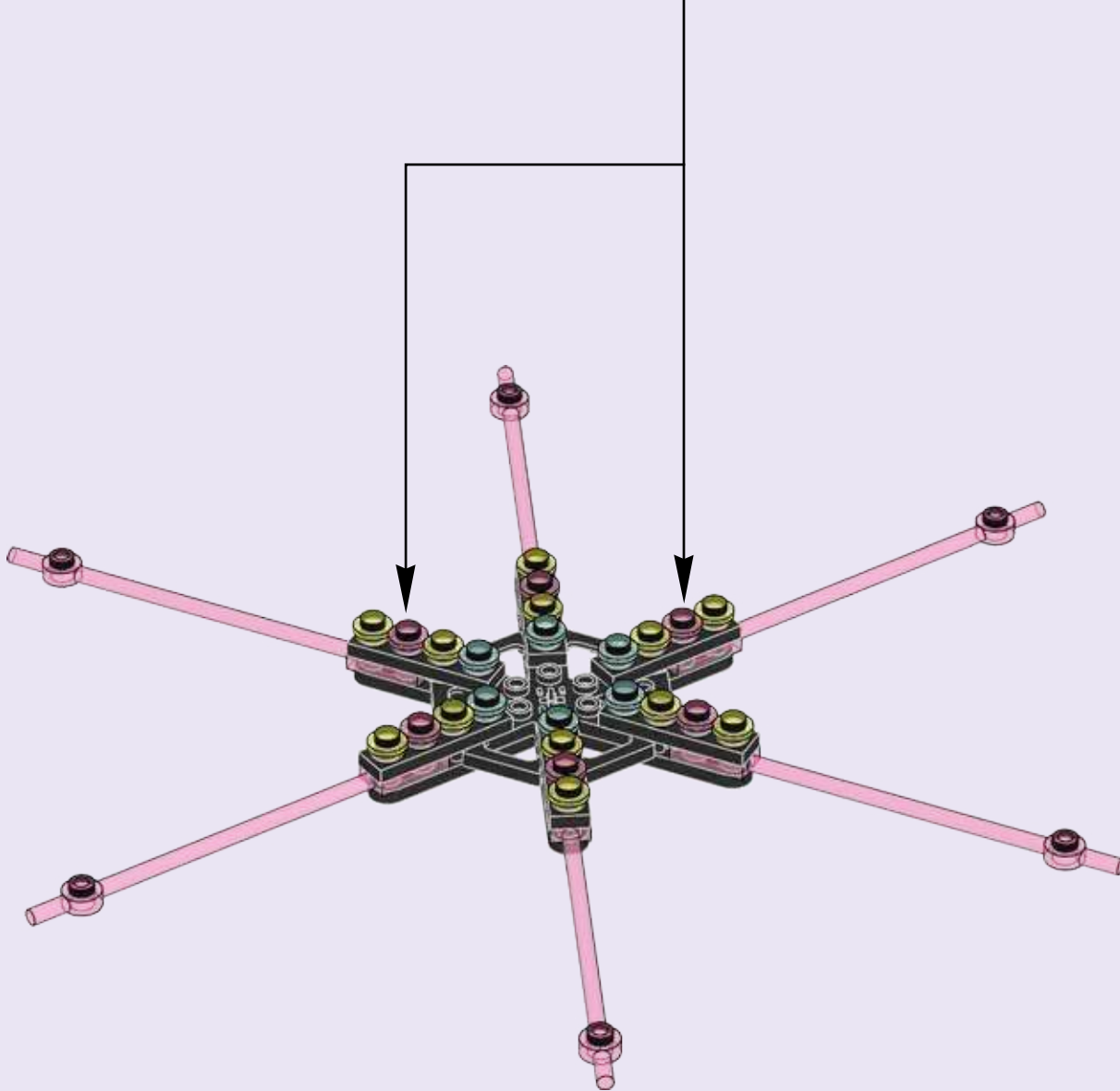



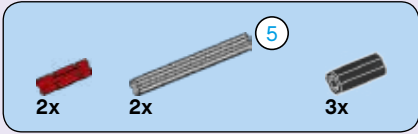
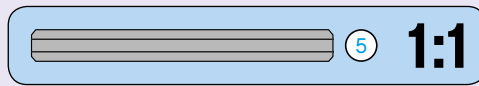

27

1

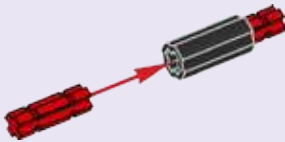

2

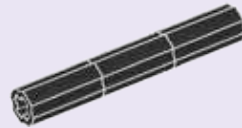

3

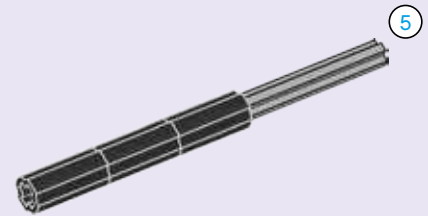

4

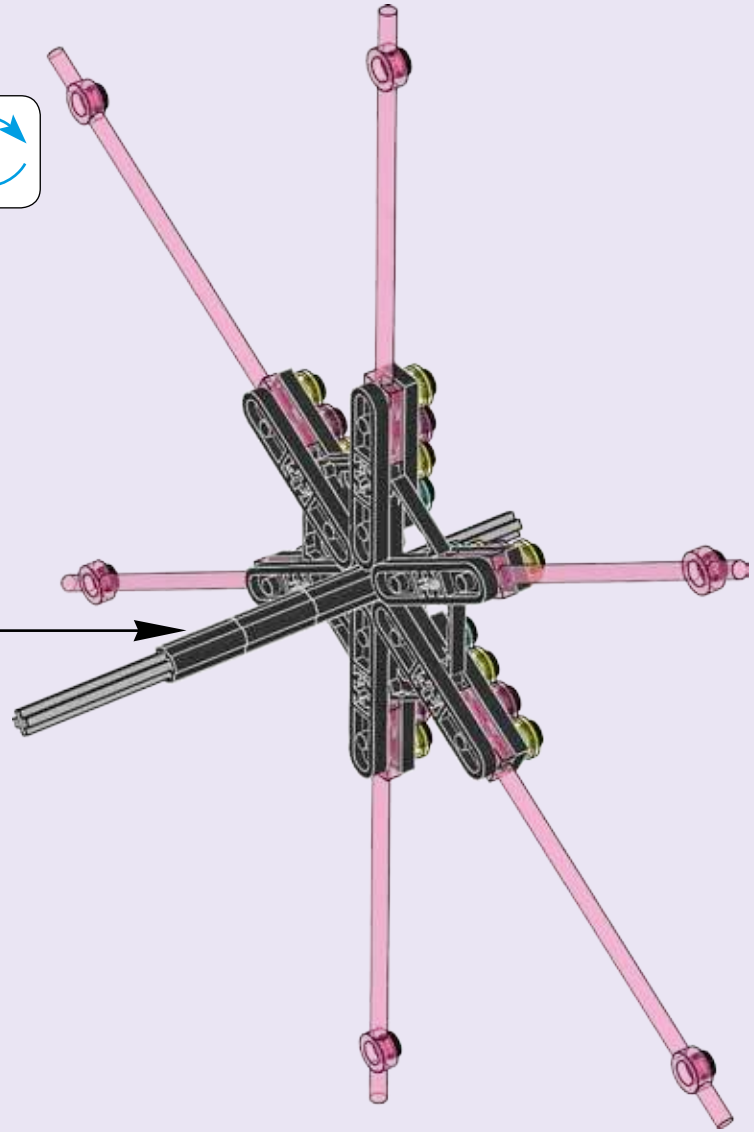
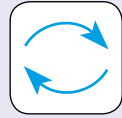
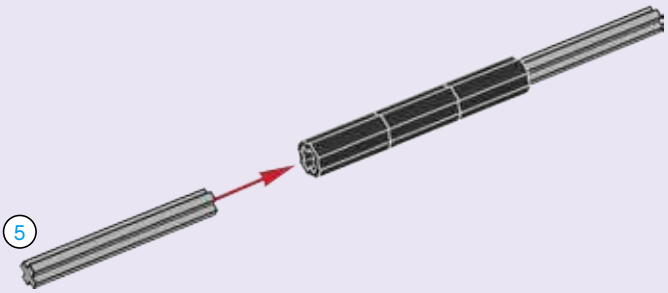

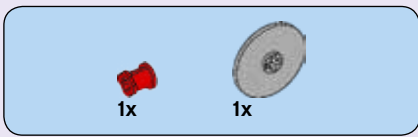

28

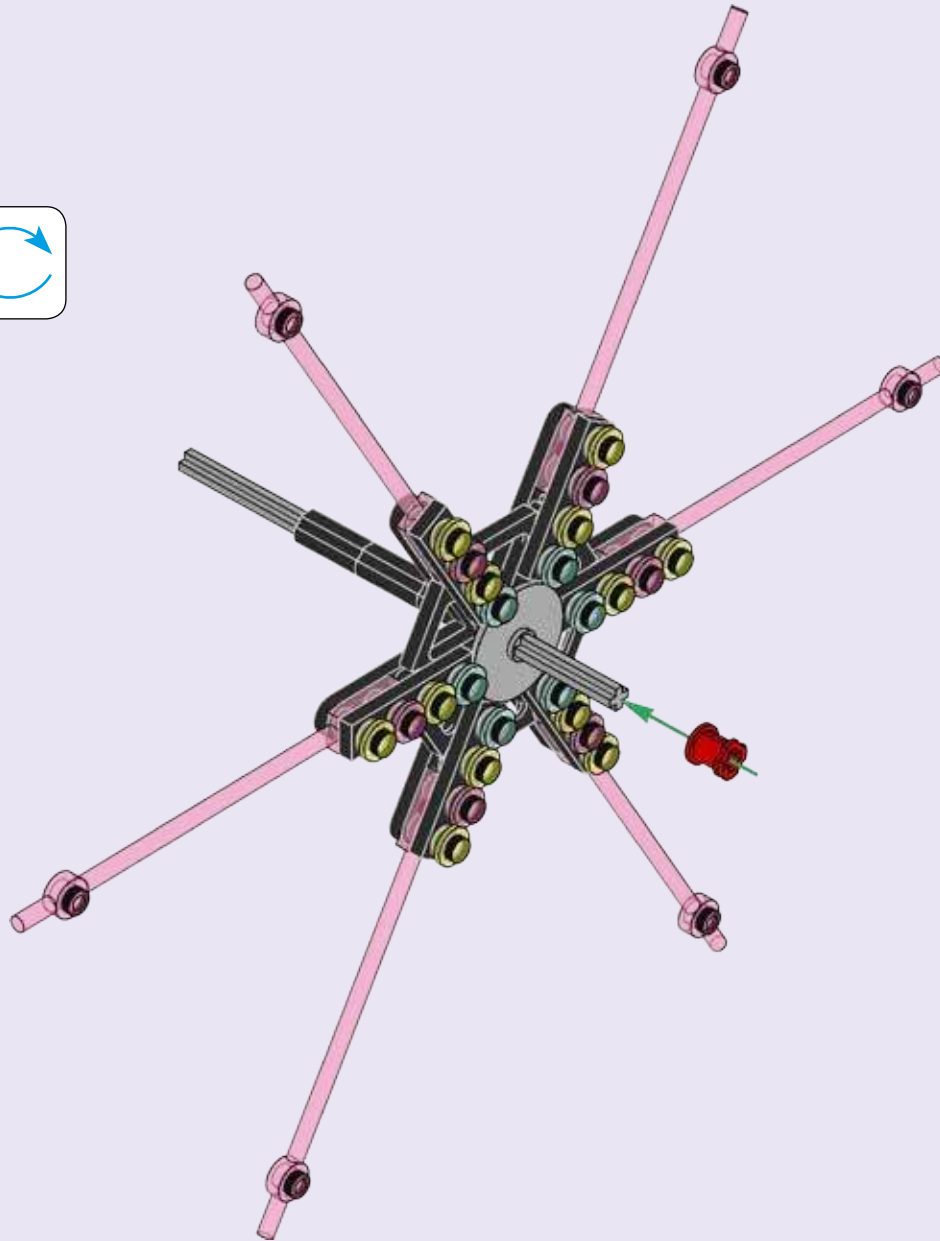
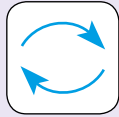

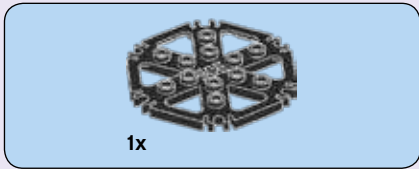
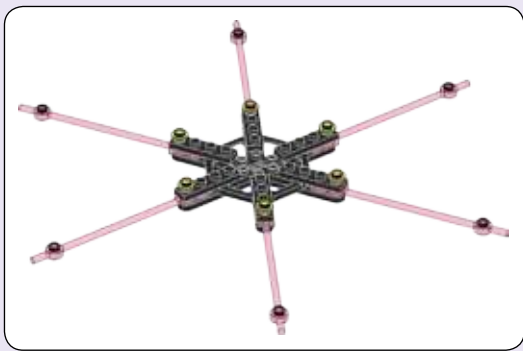

29

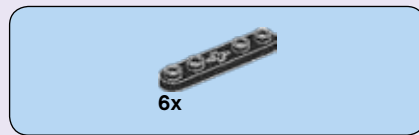

30

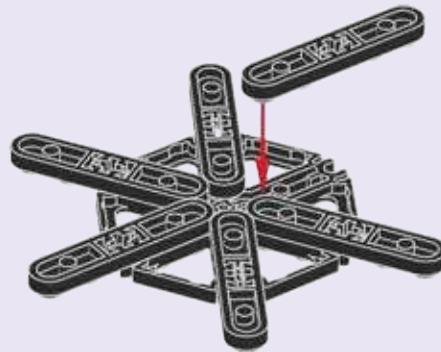

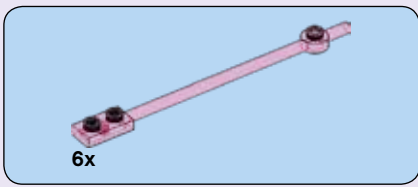

# 31

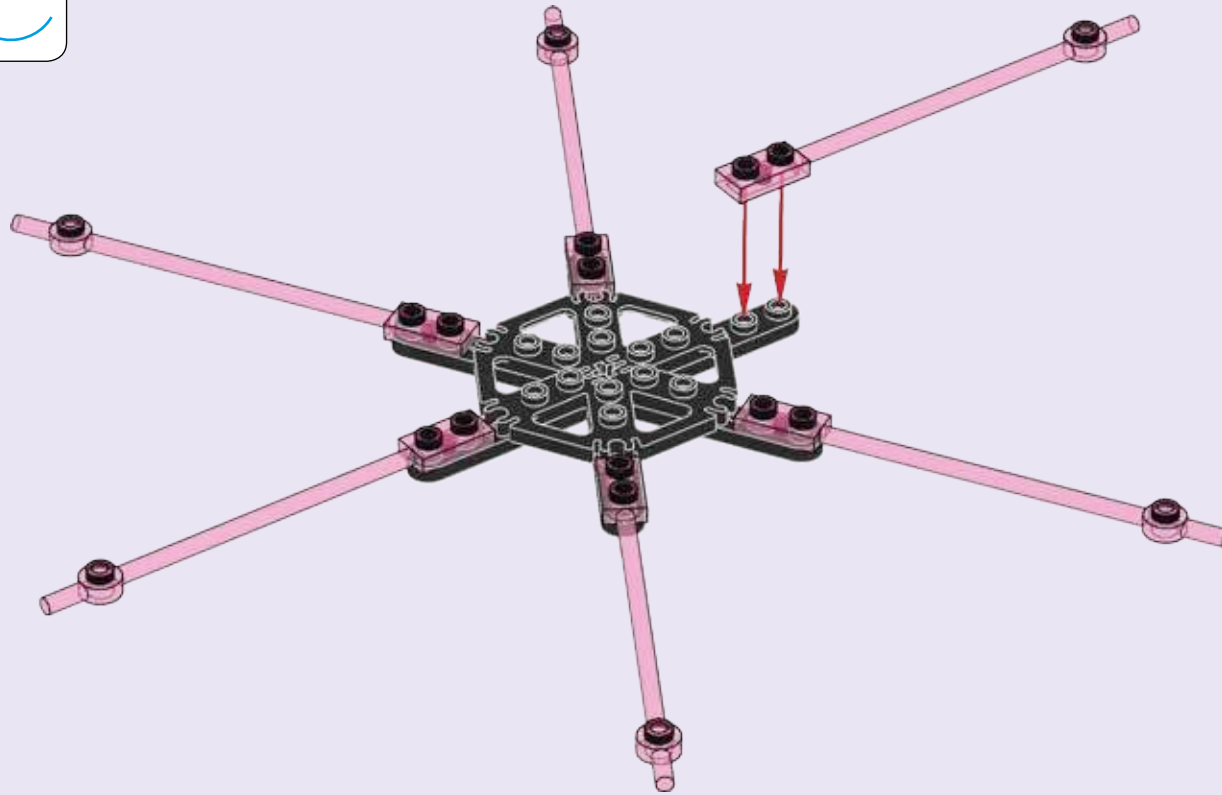
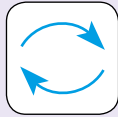

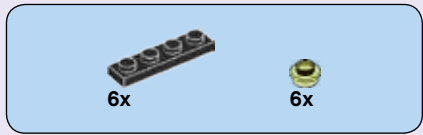

32

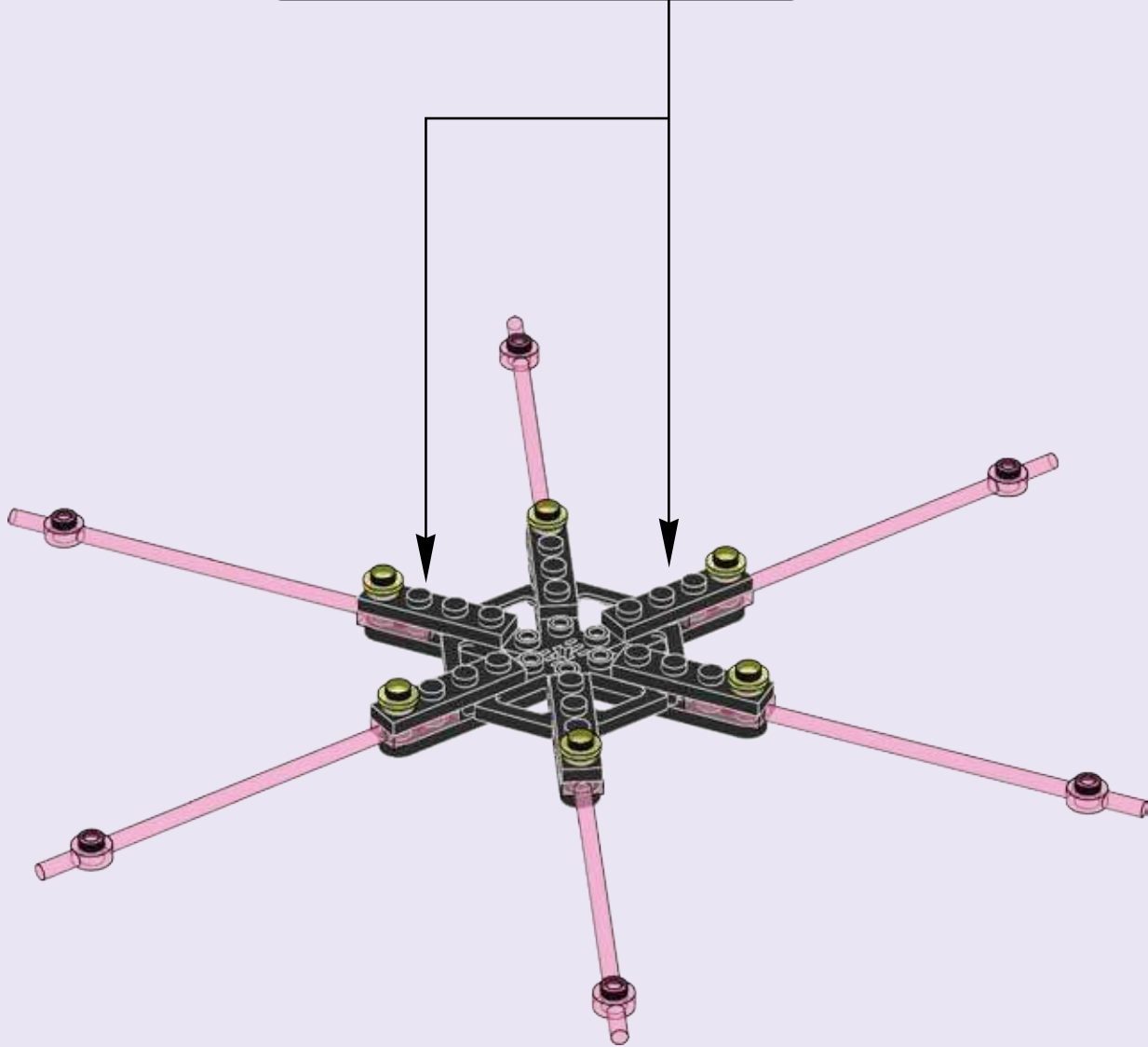

# 33

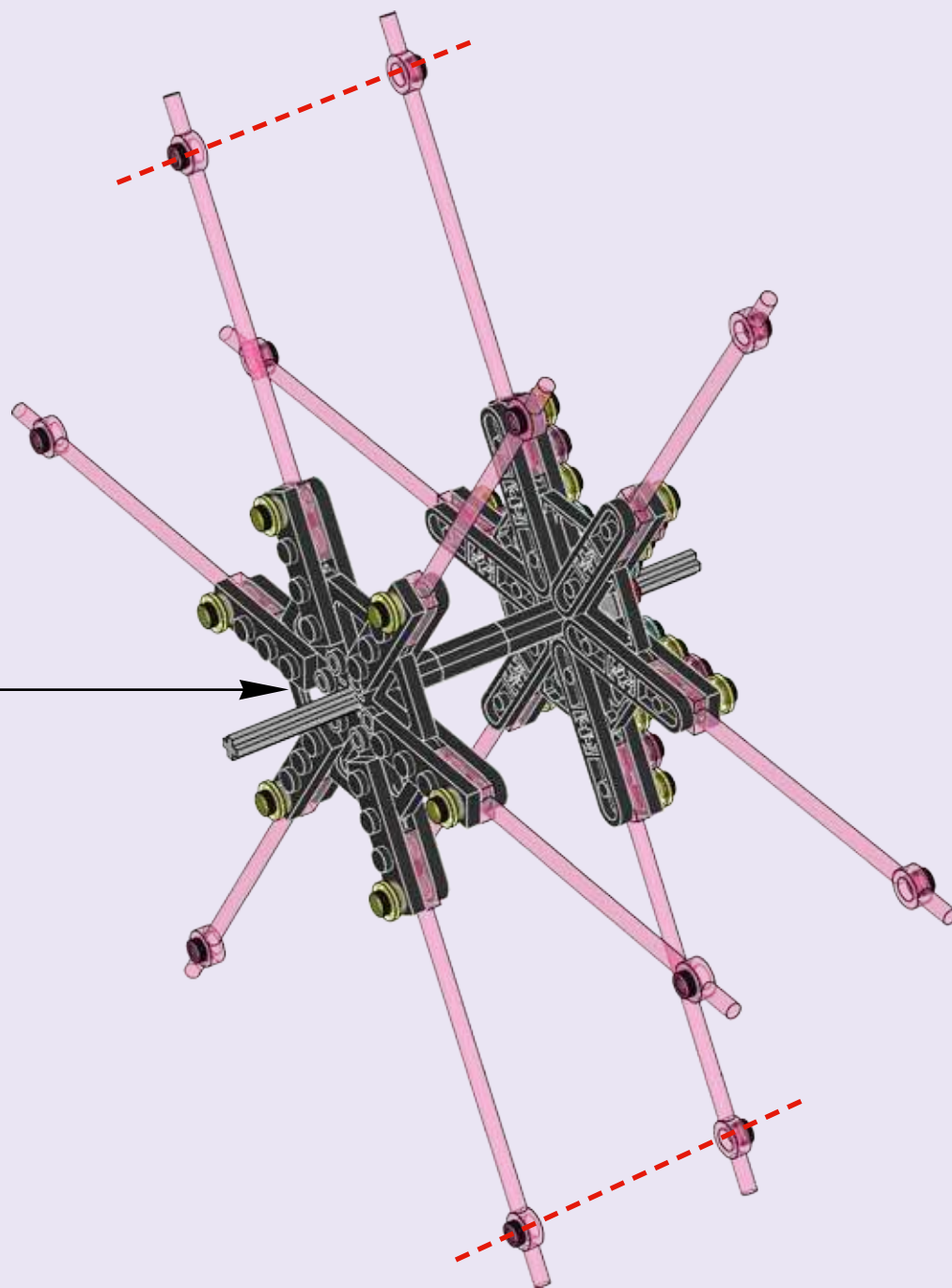
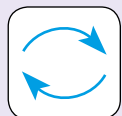

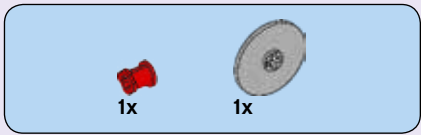

# 34

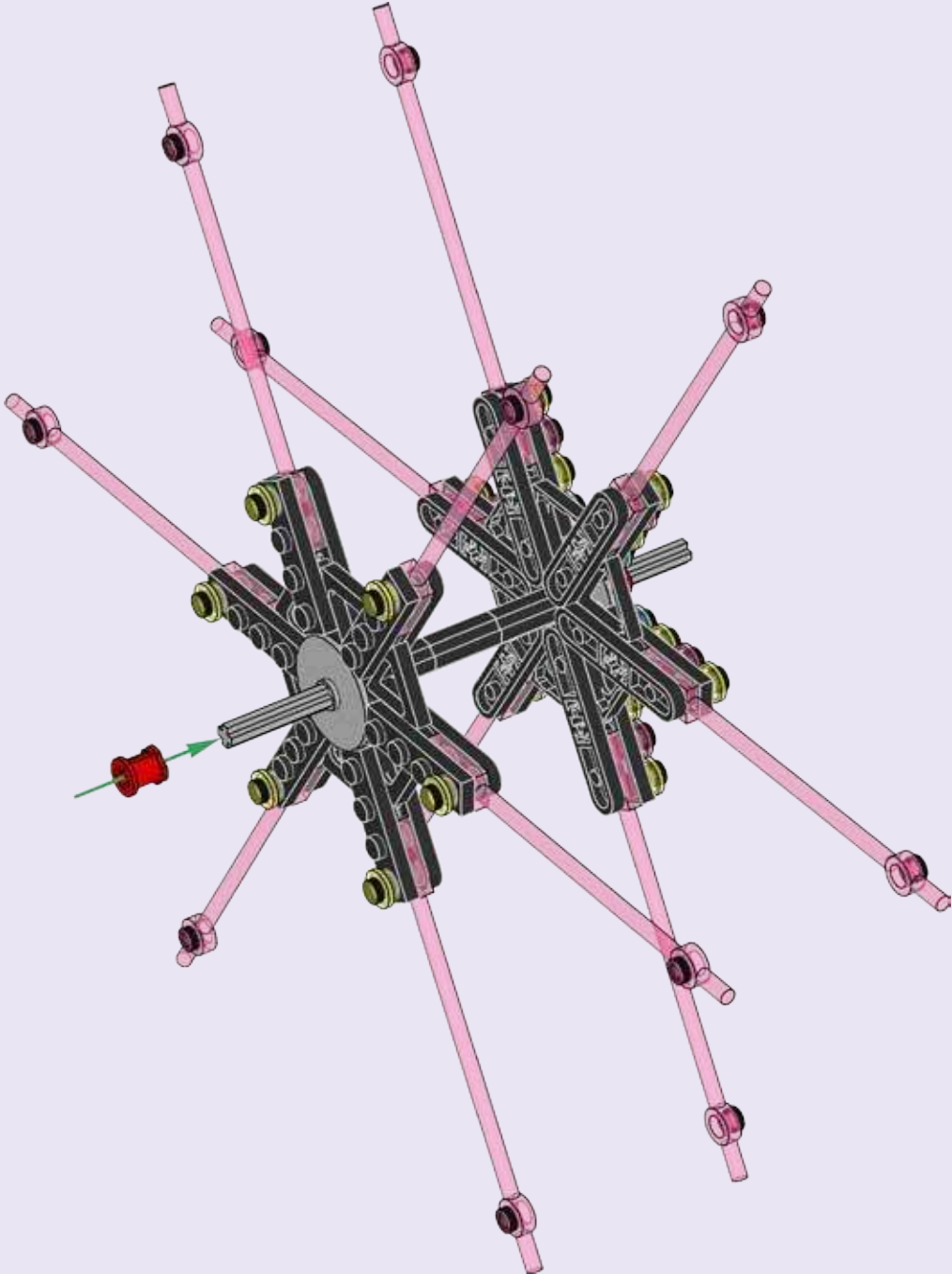



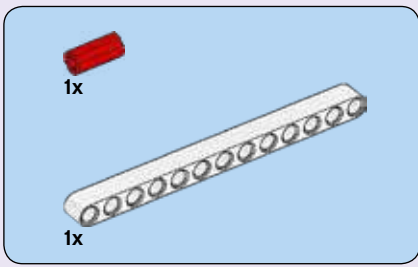

35

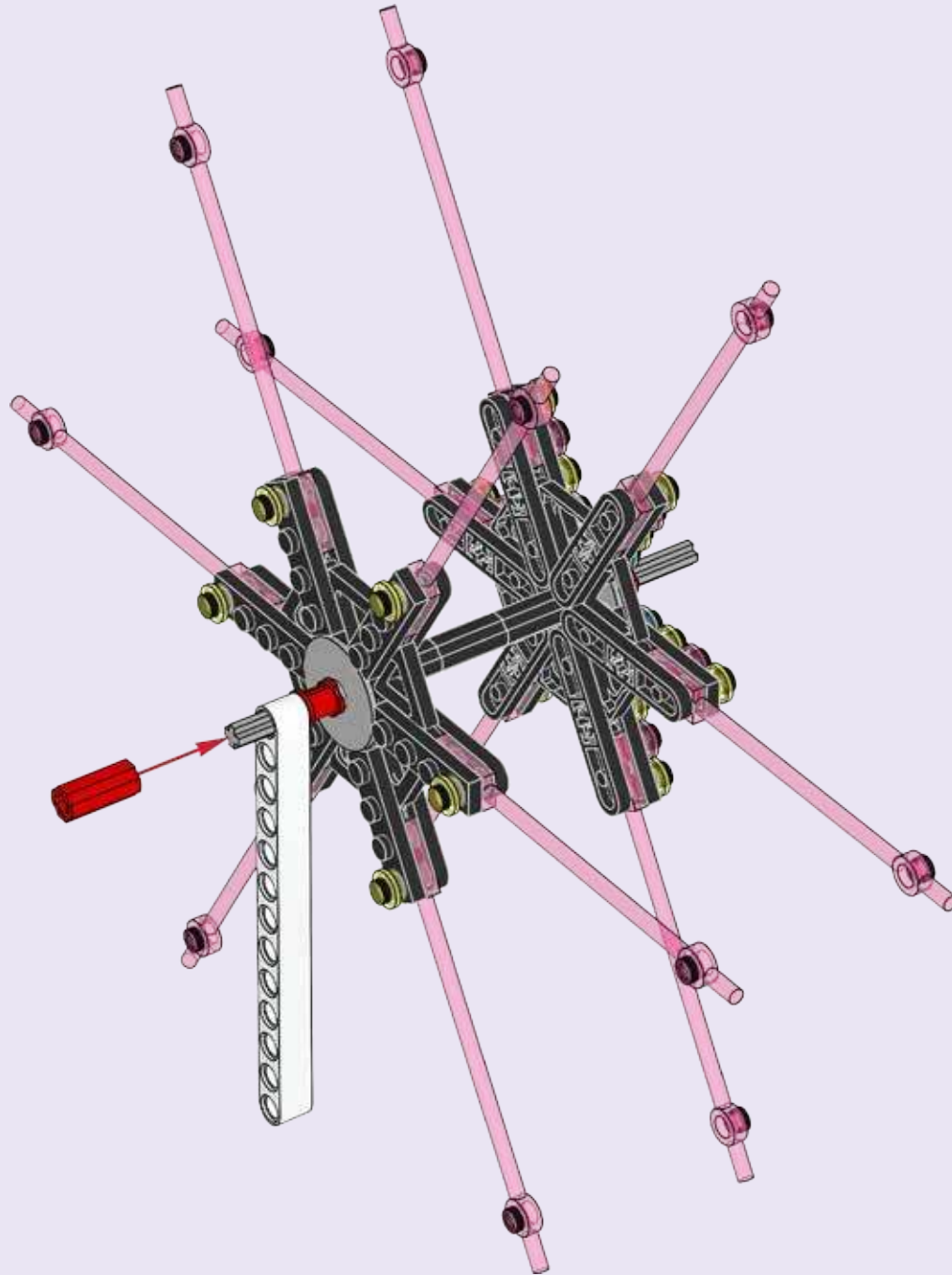

36

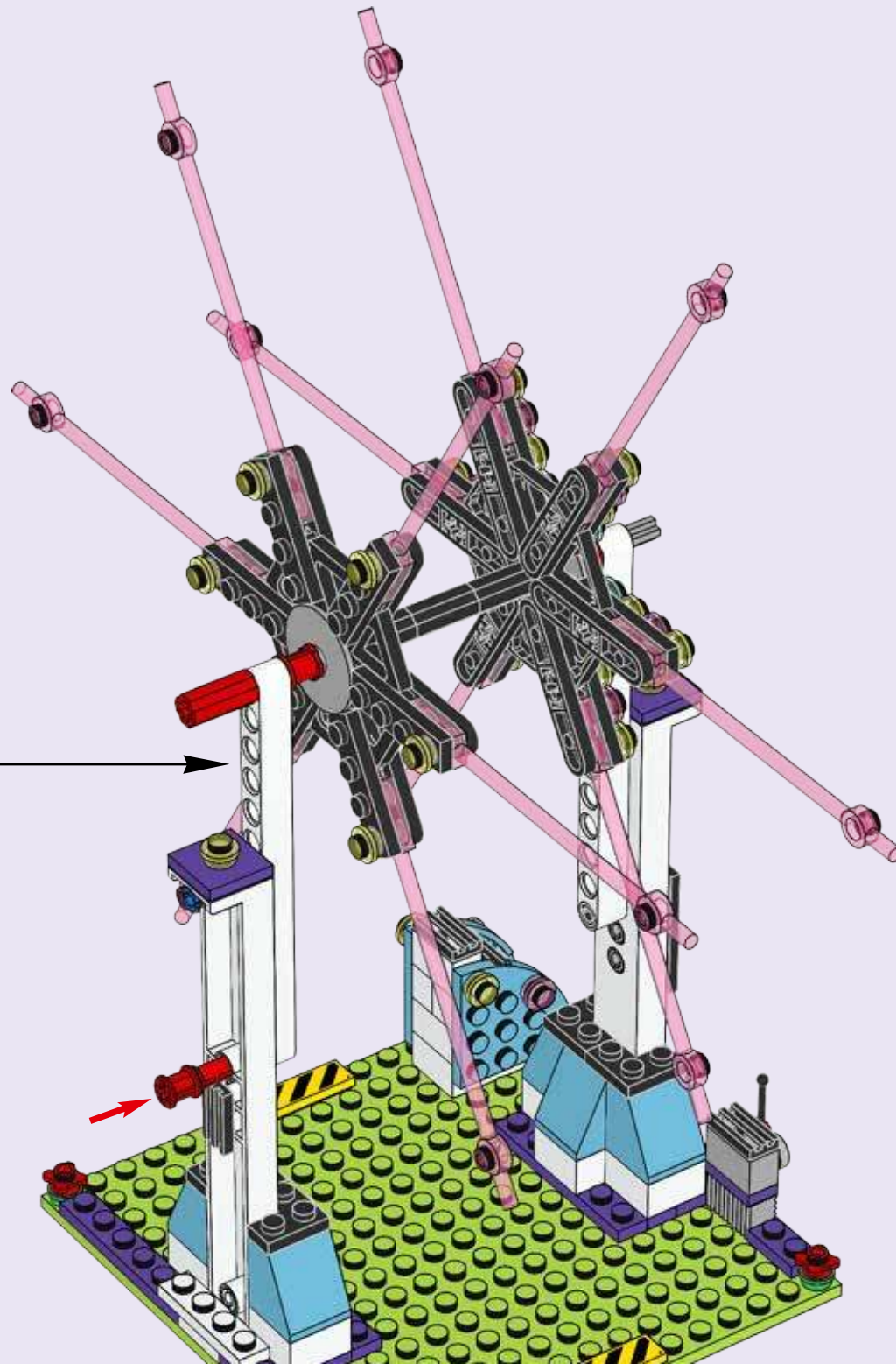

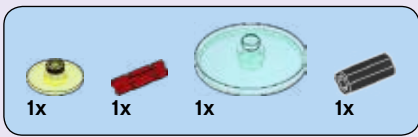

# 37

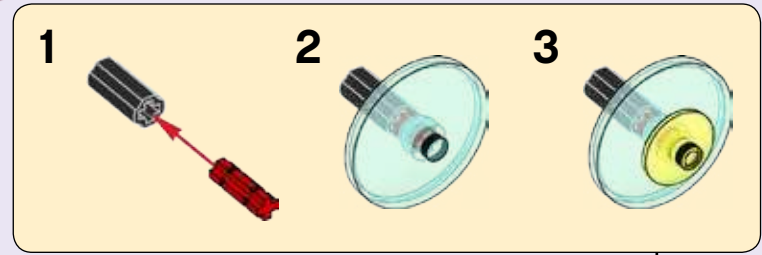
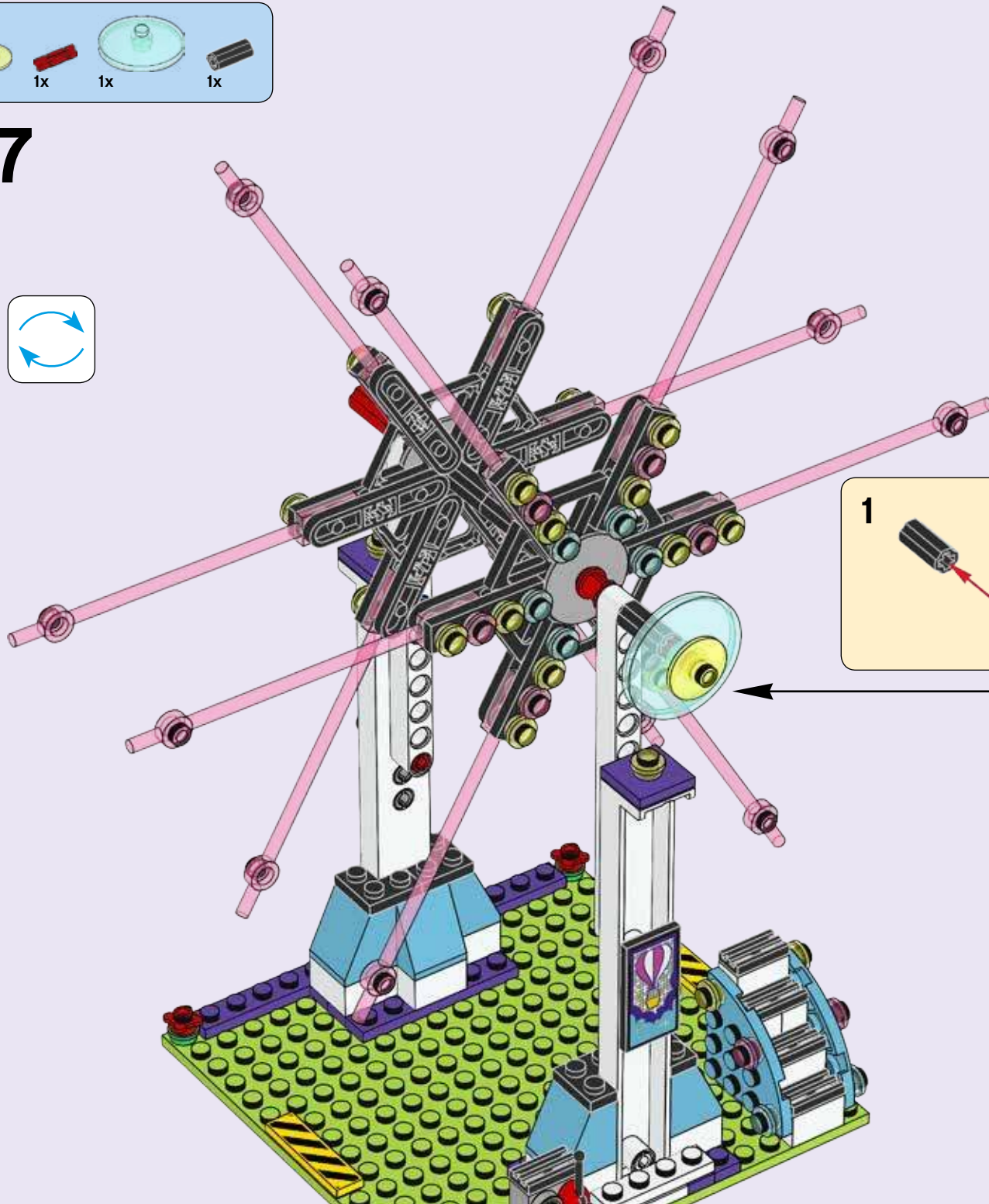

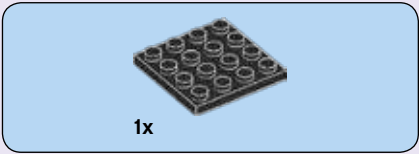
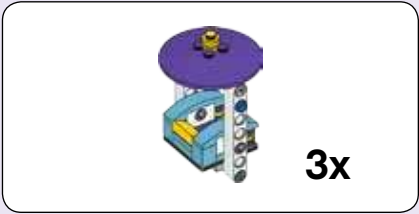
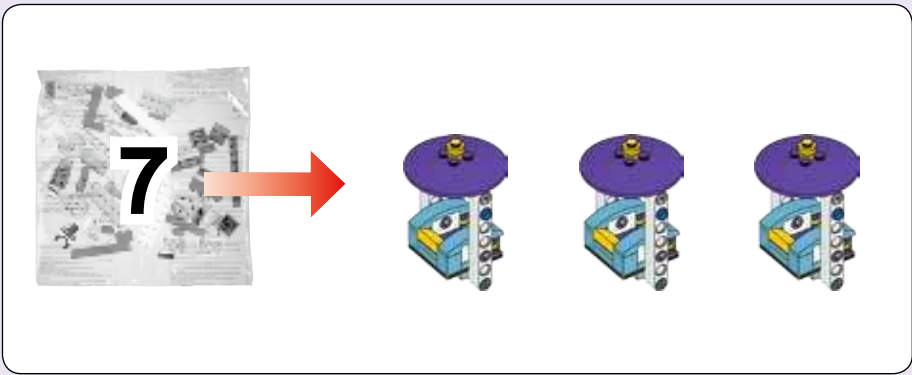

**38**

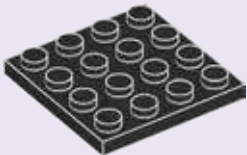

**39**



**40**

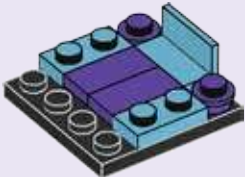



41

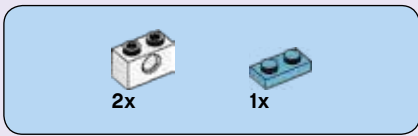
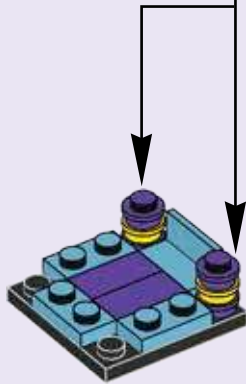

42

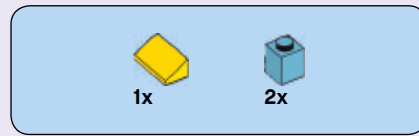
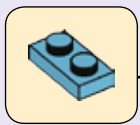

43

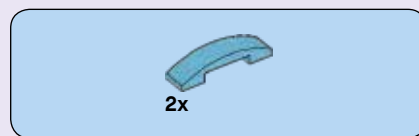
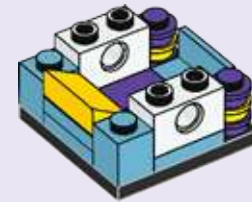

44

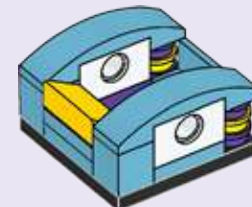

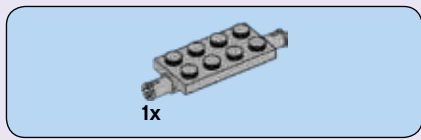

# 45

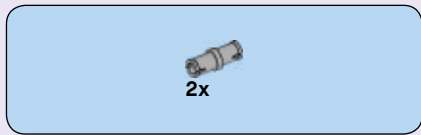
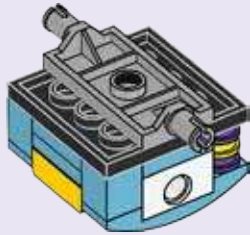

# 46

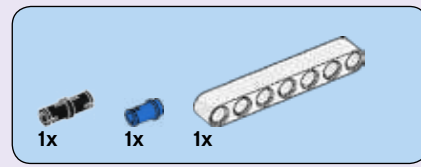
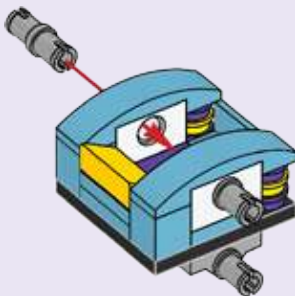
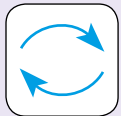

# 47

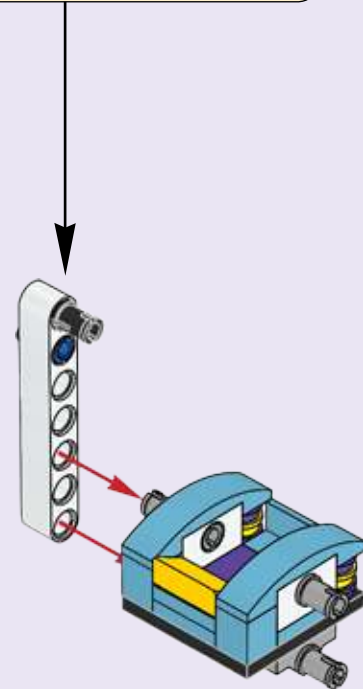
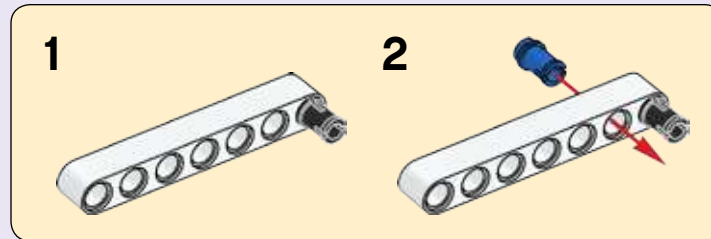

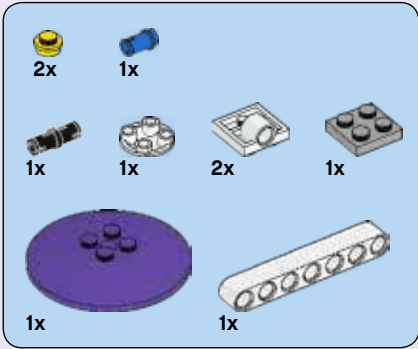
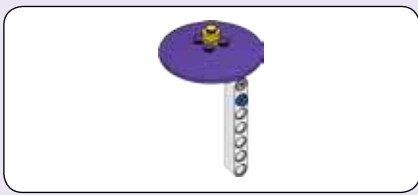

# 48

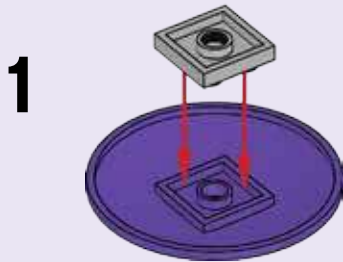

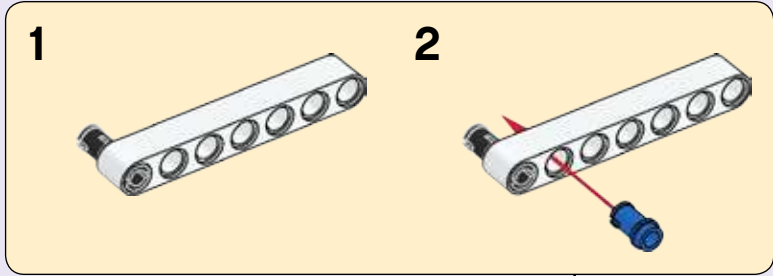

4

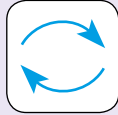

5

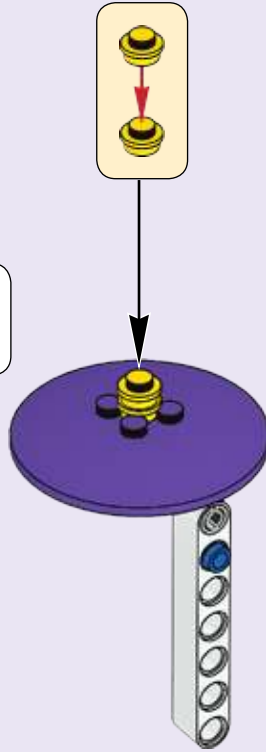

6

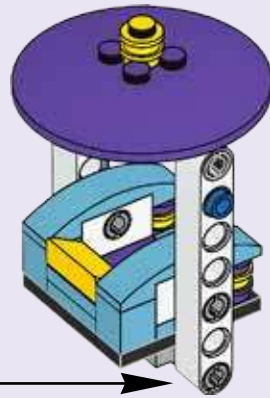

3x



49

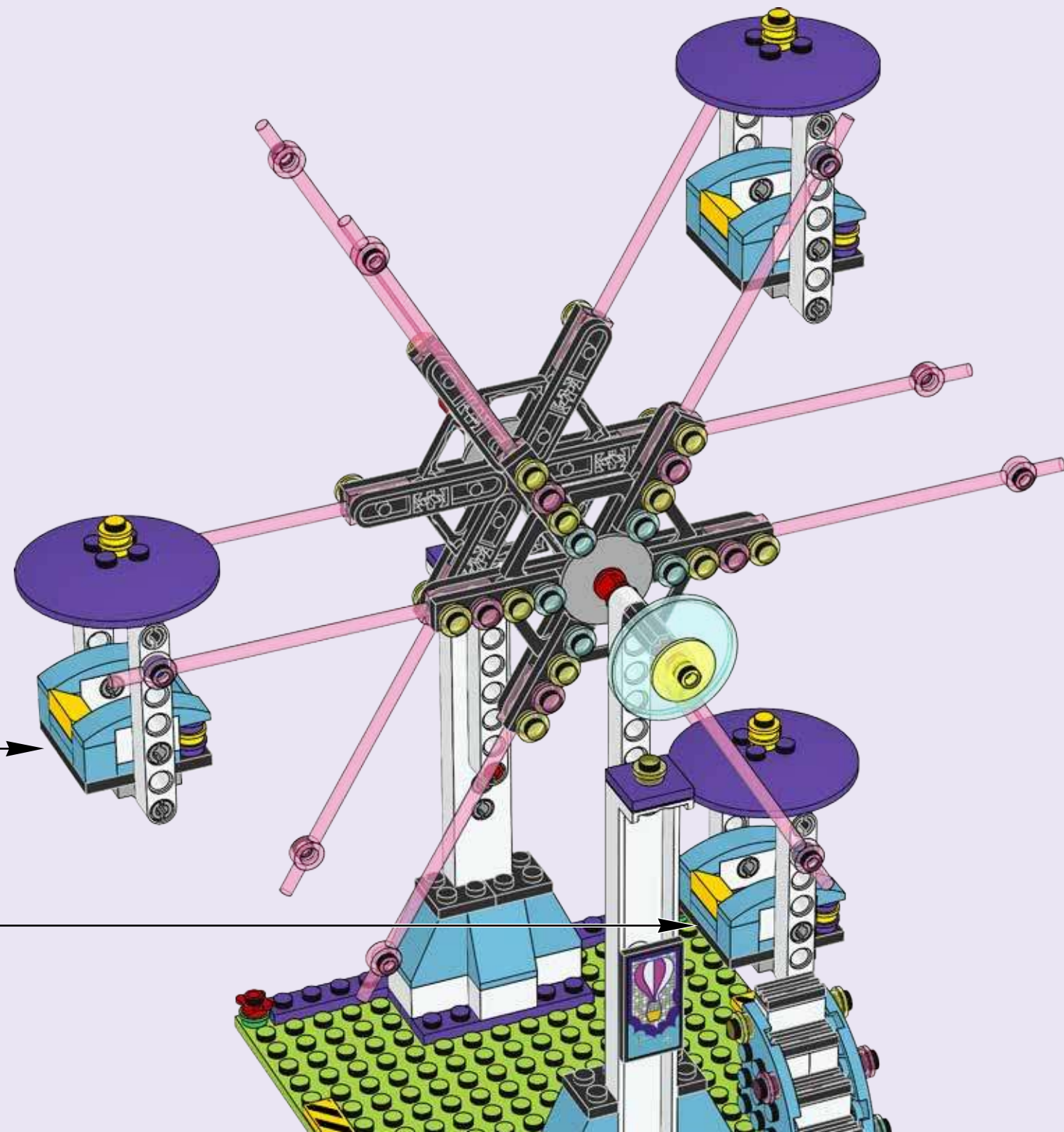

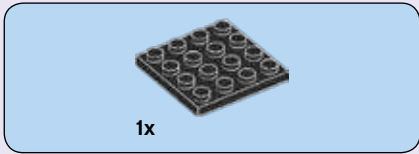
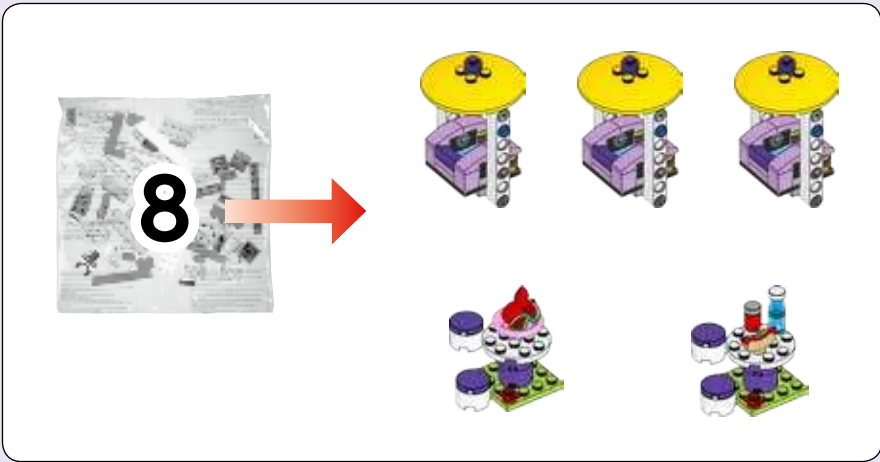

# 50

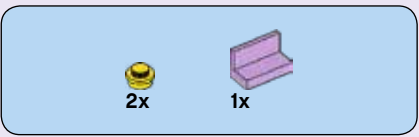
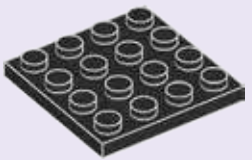

# 51



# 52

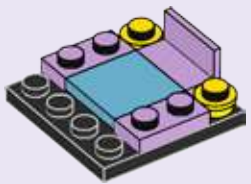



53

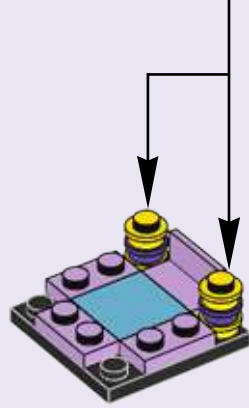

54

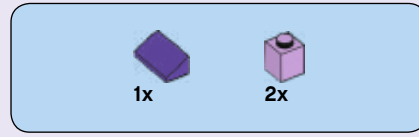
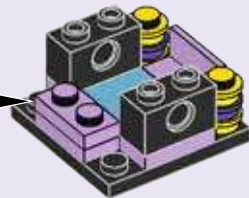
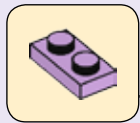

55

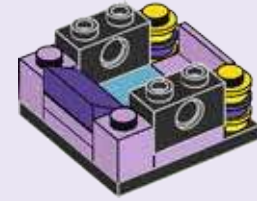

56

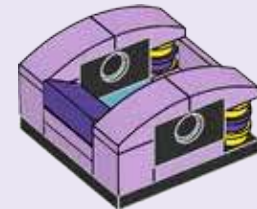

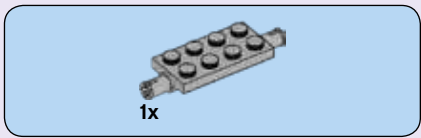

57

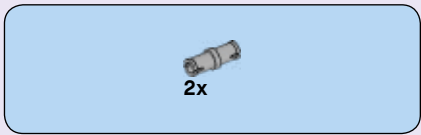
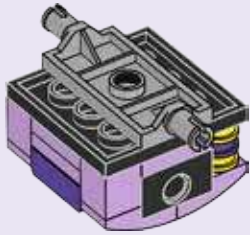

58

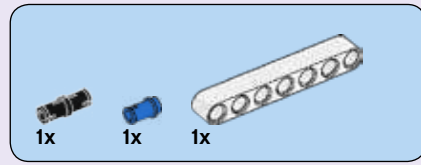
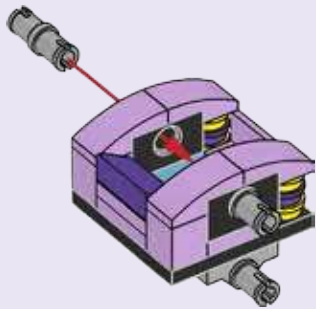

59

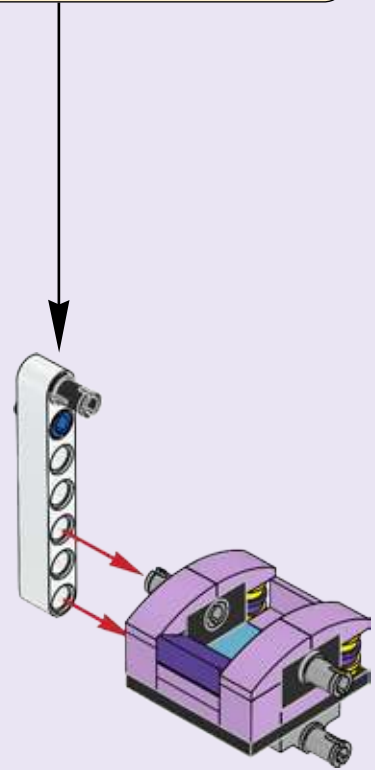
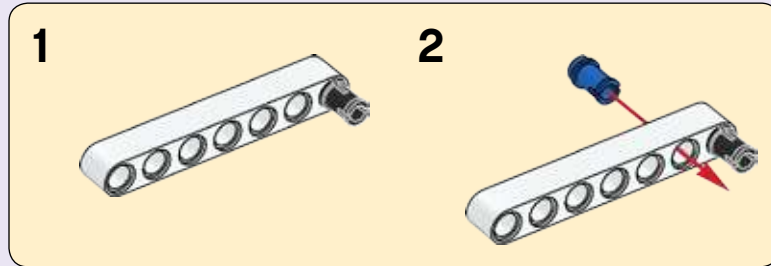



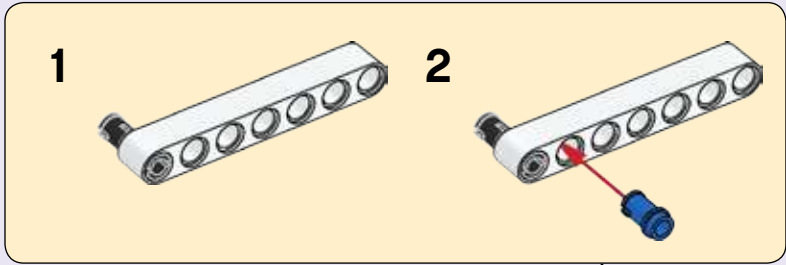

4



5

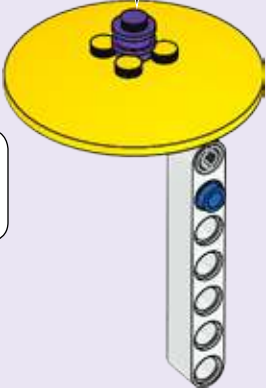

6



3x

61

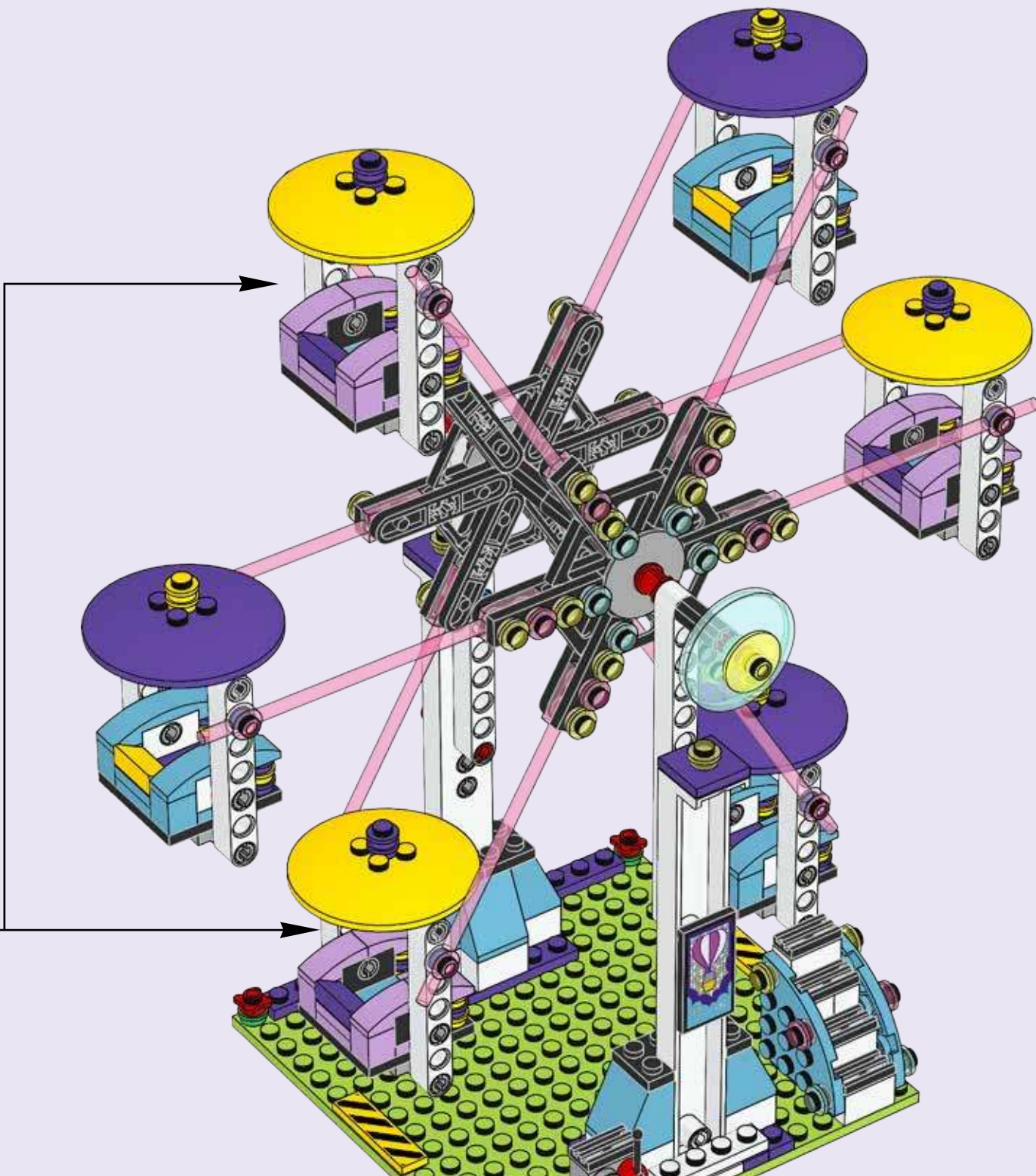



62

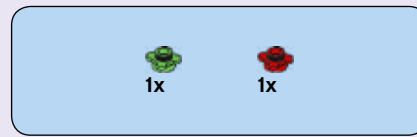
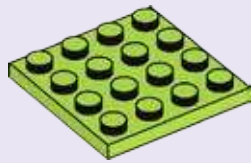

63



64

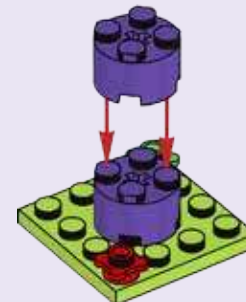



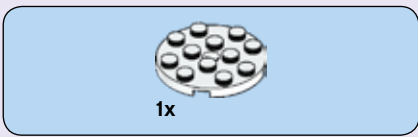

65

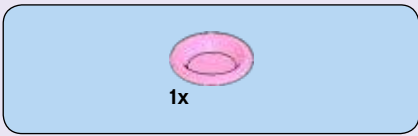

66



67

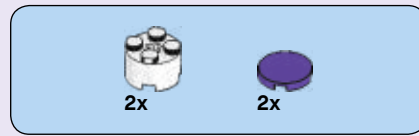

68

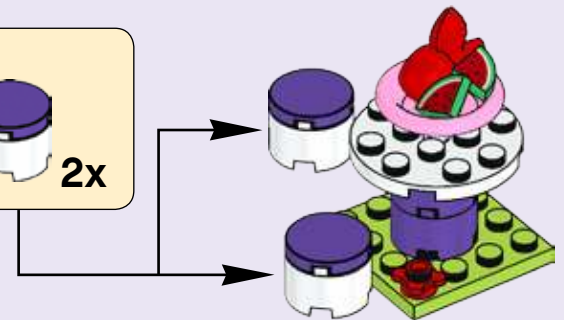



69

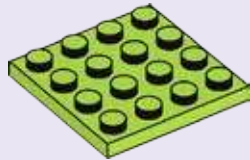

70



71

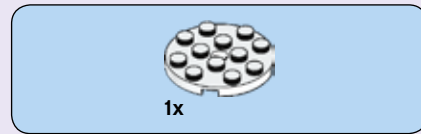
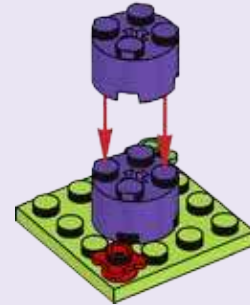

72



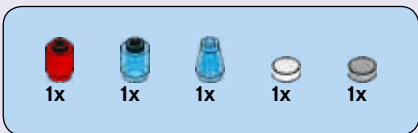

73

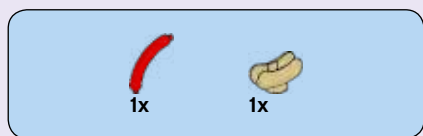
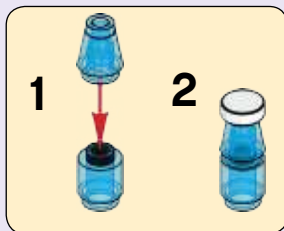
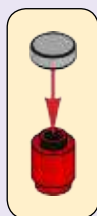

74

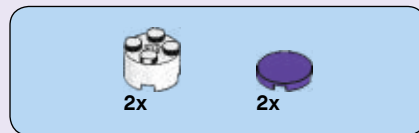
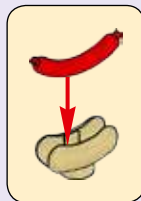

75

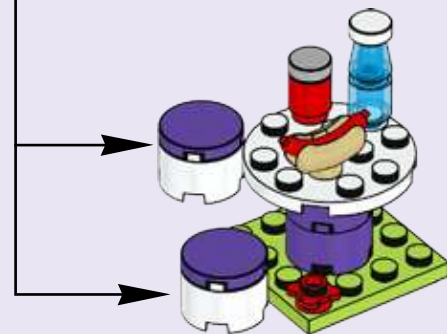

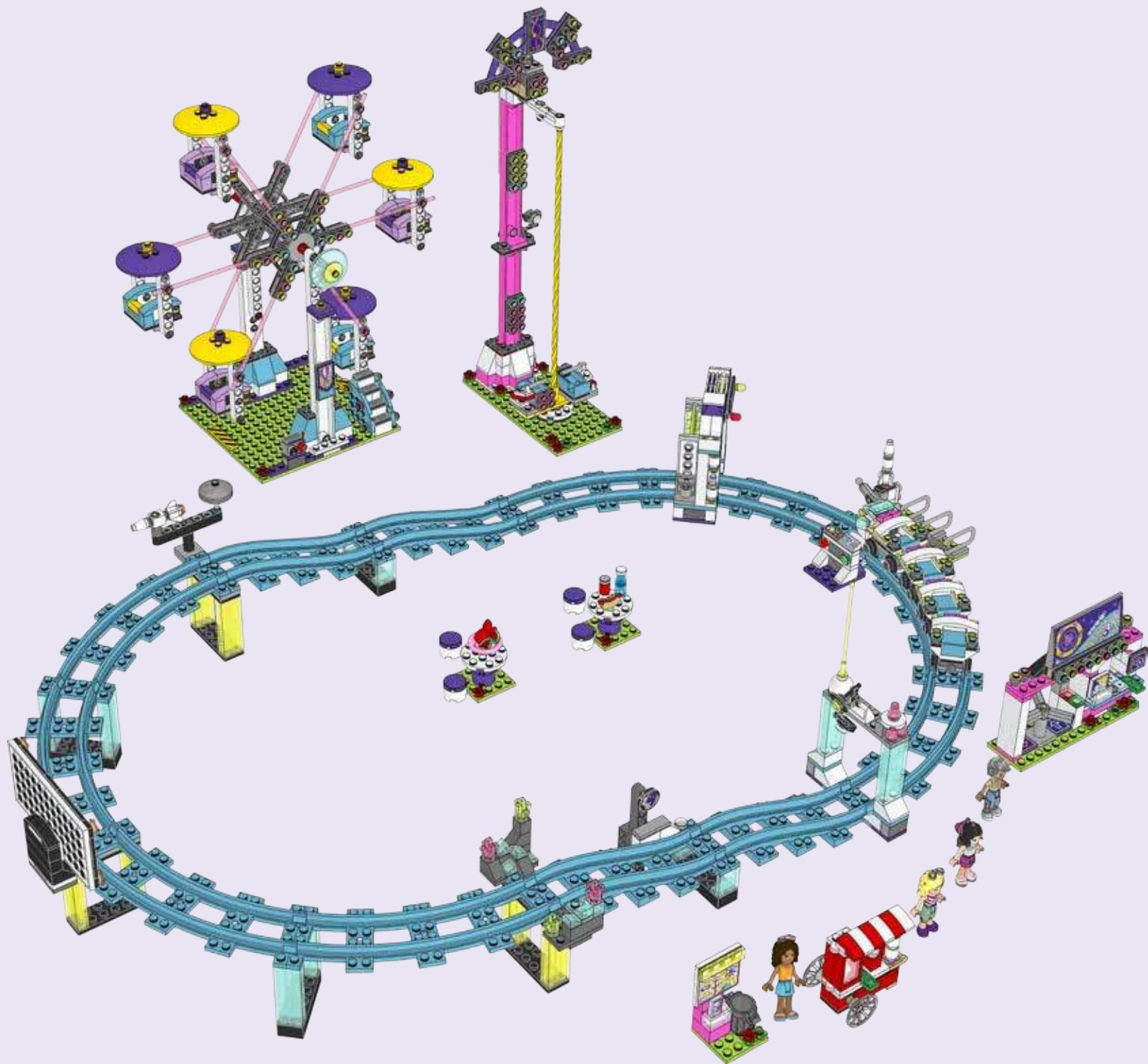



# Friends



■ 41130



■ 41129



[LEGO.com/friends](http://LEGO.com/friends)



1x 6121787  
8x 306201  
2x 4518400  
2x 4646844  
2x 625401  
1x 4118981  
1x 4125554  
2x 6152581  
2x 6054551  
5x 4558952  
8x 302401  
1x 654101  
4x 300501  
2x 245301  
2x 6025300  
3x 4547489

1x 4216652  
4x 614301  
1x 6093053  
2x 4233486  
3x 4113261  
1x 243201  
12x 300401  
4x 4598527  
2x 6058177  
4x 609101  
6x 370001  
1x 306901  
5x 302301  
9x 241201  
5x 6034044  
3x 4121932

3x 4143137  
2x 6097637  
1x 4160228  
3x 302201  
1x 6126046  
2x 306801  
6x 303901  
4x 4234525  
5x 300301  
12x 6061024  
2x 235701  
2x 6146985

3x 245401  
1x 6035539  
1x 4544140  
4x 371001  
4x 6023806  
3x 4515347  
2x 6102776  
3x 302001  
1x 300101  
4x 366601  
2x 4620761  
4x 4658973  
1x 362301

1x 617901  
6x 4278271  
2x 379501  
12x 4495927  
1x 6062279  
1x 6013938  
1x 6147214  
3x 4666579  
2x 6024495  
3x 4113917  
1x 4217562  
1x 4514554  
1x 6131896  
1x 4159739

14x 6035617  
2x 4227155  
2x 300521  
1x 6144805  
1x 6054438  
4x 4142865  
1x 4513174  
3x 6029946  
2x 6132807  
1x 4140806  
2x 4515365  
2x 243121  
2x 389421  
23x 4143005  
1x 4514553  
24x 614124  
1x 4239601

1x 306221  
3x 4550348  
2x 4119091  
1x 366624  
3x 6110037  
1x 6147018  
2x 74335  
8x 614126  
1x 6066102  
3x 300526  
12x 302426  
16x 4295370  
1x 4184169  
2x 4537551  
1x 6079894  
1x 6070695

1x 474026  
16x 4121715  
2x 4106552  
1x 6096109  
4x 4512363  
1x 4526982  
2x 306926  
6x 241226  
1x 6092585  
6x 370026  
2x 4505757  
2x 6000650  
3x 6016172  
1x 6055630  
4x 302226  
3x 306826  
6x 242026

1x 370526  
4x 243126  
1x 4613153  
16x 371026  
2x 301026  
2x 6037746  
1x 303726  
1x 6045912  
12x 4114689  
10x 302026  
3x 4560182  
6x 4243819  
4x 4181144  
7x 379526

2x 4539442  
1x 4495935  
2x 346026  
3x 4569058  
2x 6151225  
2x 4295260  
15x 4619599  
3x 4650498  
2x 4536998  
2x 4278412  
1x 6054554  
1x 6139647  
1x 4497943  
1x 4646864  
1x 3003941  
27x 4163917  
2x 6052994

11x 6073445  
2x 6051918  
4x 4640026  
6x 4283915  
1x 4667222  
1x 4293877  
1x 3006843  
1x 4567331  
2x 3005747  
5x 4646860  
1x 4216384  
43x 3005749  
10x 6076751  
1x 3006349  
10x 6102038  
6x 6066338

1x 6030742  
1x 256949  
3x 6125698  
34x 4599535  
1x 6114993  
2x 6099532  
12x 6147035  
4x 4504850  
2x 6112967  
6x 6097053  
3x 6147006  
12x 6099190  
12x 6097647  
2x 6051541

1x 6023827  
1x 6126002  
1x 6096991  
1x 6151298  
1x 6141743  
3x 4650260  
4x 4211483  
1x 4211622  
1x 4211535  
1x 4211552  
1x 4211375  
14x 4211807  
8x 4211383  
3x 4512360  
1x 4526985  
1x 4227776

4x 4211398  
2x 4211437  
1x 6015344  
1x 4228198  
2x 4657366  
2x 4654580  
2x 4667578  
1x 4502595  
2x 6093527  
1x 4211376  
3x 4530469  
6x 4211397  
4x 4211365  
2x 6045988  
1x 4211815

1x 4211865  
1x 4558169  
8x 4211504  
1x 4211529  
3x 4211584  
2x 6015347  
2x 4211395  
1x 4211444  
2x 4211639  
6x 4211572  
1x 4535768  
3x 4211406  
1x 6115046  
1x 6100030

1x 4211098  
1x 6055313  
4x 6039479  
4x 4211135  
2x 4210697  
1x 4583879  
2x 4211104  
1x 4626645  
3x 4211065  
1x 4645730  
1x 4210678  
8x 6127601  
5x 4621545  
8x 6057387  
3x 4517992



2x  
6150314



2x  
4621542



2x  
6074906



1x  
4618629



1x  
6086923



24x  
4566522



1x  
6030534



3x  
4566607



4x  
6097501



4x  
4622176



6x  
4613192



2x  
4655690



10x  
4655695



4x  
6057390



2x  
4659770



2x  
6047422



2x  
6109766



2x  
6030277



4x  
6147010



6x  
4655691



1x  
6109819



3x  
6117755



1x  
6017024



1x  
6017048



1x  
6149684



1x  
6049751



4x  
6070746



1x  
6096113



1x  
4570481



10x  
6057034



2x  
6134621



2x  
4626400



2x  
6096717



1x  
6017034



1x  
6034812



1x  
6073451



1x  
6100431



1x  
6078241



1x  
6030333



2x  
4617460



6x  
4619652



1x  
6139433



1x  
6131878



12x  
6097419



1x  
4649741



11x  
4618647



2x  
6133911



4x  
4625032



6x  
6060857



6x  
6109828



6x  
6097093



2x  
4655256



2x  
6056271



2x  
6056271



1x  
6146926



1x  
6146926



1x  
6054390



1x  
6054390



3x  
4620671



3x  
4620671



1x  
4527977



1x  
4527977



1x  
4654448



1x  
4654448



1x  
4654448

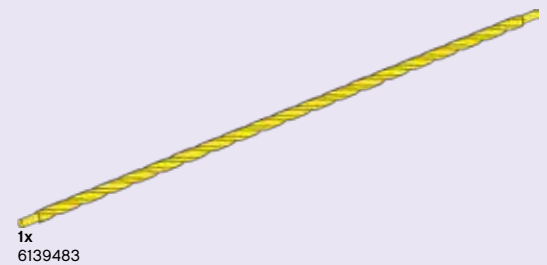

1x  
6139483

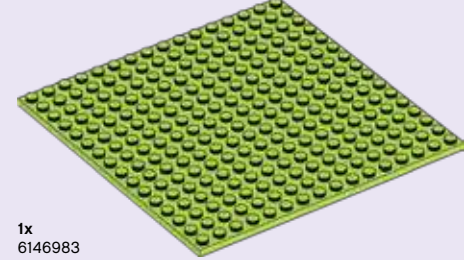

1x  
6146983

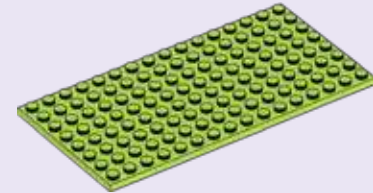

1x  
6129600

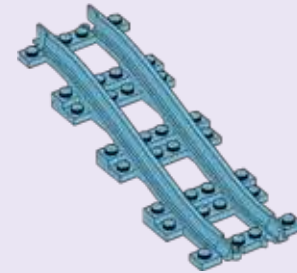

4x  
6147028

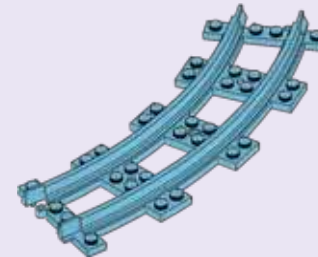

8x  
6125658



**Customer Service**  
 Kundenservice  
 Service Consommateurs  
 Servicio Al Consumidor  
 LEGO.com/service or dial

00800 5346 5555 :       

1-800-422-5346 :  





# Friends



41128



41129



41130



41130



41129



41128



41127



41127



# ELVES



41178



41180



41177



41179



41176



41175



41174



41173



41172



41171



# Friends™



LEGO.com/friends



GET IT ON  
Google play  
Download on the  
App Store

Google Play is a trademark of Google Inc.  
Apple, the Apple logo and iPad are trademarks of Apple Inc.

# WIN

GO TO [WWW.LEGO.COM/PRODUCTFEEDBACK](http://WWW.LEGO.COM/PRODUCTFEEDBACK) AND  
GIVE US YOUR SHORT **FEEDBACK** ABOUT THIS  
LEGO® SET FOR A CHANCE TO WIN  
A COOL LEGO PRIZE.

Terms & Conditions apply

## LEGO.com/productfeedback

### GEWINNE

Erzähle uns auf  
[www.LEGO.com/productfeedback](http://www.LEGO.com/productfeedback)

etwas über die Erfahrungen, die  
du mit diesem LEGO® Set gemacht  
hast, und sichere dir die Chance  
auf einen coolen LEGO Preis!

Es gelten die  
Teilnahmebedingungen

### GAGNE

Rends-toi sur  
[www.LEGO.com/productfeedback](http://www.LEGO.com/productfeedback)

et donne-nous quelques com-  
mentaires sur ce produit LEGO®  
pour avoir une chance de gagner  
un prix LEGO !

Voir Conditions Générales

### GANAN

Visita  
[www.LEGO.com/productfeedback](http://www.LEGO.com/productfeedback)

y envíanos tu opinión acerca de  
este set LEGO®. ¡Participarás en el  
sorteo de un premio LEGO!

Términos y Condiciones aplicables

### 获取奖品

登录  
[www.LEGO.com/productfeedback](http://www.LEGO.com/productfeedback)

给出关于此乐高®套装的简短反馈，  
就有机会获得炫酷乐高奖品

《条款及条件》适用

### 경품 당첨 기회

[www.LEGO.com/productfeedback](http://www.LEGO.com/productfeedback)

페이지로 이동하여 이 레고® 세트에  
대한 간략한 피드백을 보내 주시고  
멋진 레고 경품을 탈 수 있는 기회도  
잡으십시오

약관 적용

### ЗАПОЛНИ АНКЕТУ И ПОЛУЧИ ПРИЗ

Перейди по ссылке  
[www.LEGO.com/productfeedback](http://www.LEGO.com/productfeedback)

ответь всего на несколько во-  
просов об этом наборе LEGO®,  
и у тебя появится шанс выиграть  
замечательный приз от компании  
LEGO.

Применяются Условия и правила  
участия