

● 50 mm F1.4 AS UMC Instruction Manual

We believe that you will have a special photographic experience with the 50 mm F1.4 AS UMC lens.

Advantages of 50 mm F1.4 AS UMC

1. 50 mm F1.4 AS UMC full frame image size.
2. It compensates for aberrations by using a glass aspherical lens and hybrid aspherical lens and, at the fully opened position, produces a high resolution and a high contrast at the center of the lens as well as around the periphery.
3. The flower-shaped hood and UMC (Ultra Multi Coating) design suppresses flaring and ghost images.
4. Robust durability with a high strength aluminum body.

This product is designed with its own mount so you can easily take photographs by mounting the lens directly onto the camera, without installing an additional adaptor.

- ※ Read this instruction manual carefully to familiarize yourself with your lens for correct use.
- ※ Please read the Safety Precautions at the back of this instruction manual prior to use.

● Please read this instruction manual prior to use. ●

1. Component Names

[Figure]

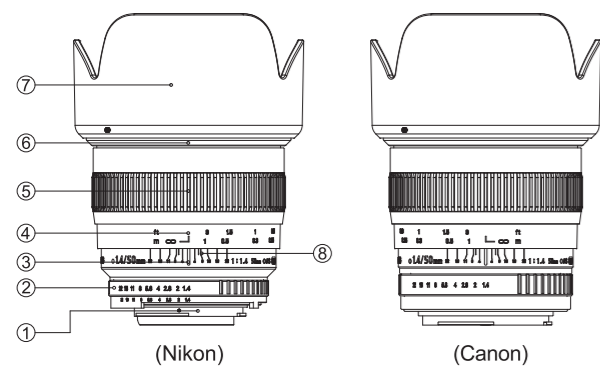

- ① Mount (camera locking area)
- ② Aperture adjustment ring
- ③ Reference line (Range finder, Aperture value)
- ④ Focus scaling ring
- ⑤ Focusing ring
- ⑥ Hood locking tube
- ⑦ Hood
- ⑧ Depth of field indication line

● AS (Aspheric) : Aspherical lens (Glass aspherical: GAS, Hybrid aspherical:HAS)

● UMC : Ultra Multi Coating

2. Attaching and Detaching

The 50 mm F1.4 AS UMC lens mount is uniquely designed for Nikon (Fujifilm) F, Fuji X, Pentax (Samsung GX) K, Sony (Minolta), Canon EOS, Canon M, Four Thirds, Micro four thirds, Sony E, Samsung NX compatible cameras.

[Attaching]

1. Hold the hood of the lens gently.
2. Align the depth of field scale of the lens with the lens attachment reference point on the camera.
3. Push the lens into the camera and turn the lens gently until it makes a clicking sound and the depth of field scale is positioned at the top.

[Detaching]

Hold the hood locking area of the lens softly, press the lens release button on the camera, turn the lens until the depth of field scale of the lens is aligned with the lens ring mount of the camera, and then pull the lens out.

3. Focus Adjustment

You can adjust the focus by turning the focusing ring when using the 50 mm F1.4 AS UMC lens, as it is a Manual Focus (MF) adjustment lens.

[Nikon (Fujifilm) F / Pentax (Samsung GX) K Mount]

- ① To change the focus from a subject that is far away to a subject that is close, turn the focusing ring to the left (from ∞ to 0.45) and focus on the clearest subject using the indication signal on the camera or by checking visually.
- ② To change the focus from a subject that is close to a subject that is far away, turn the focusing ring to the right (from 0.45 to ∞) and focus on the clearest subject using the indication signal on the camera or by checking visually.

[Sony(Minolta) / Canon / Sony E / Fujifilm X / Canon M / MFT / FT / Samsung NX Mount]

- ① To change the focus from a subject that is far away to a subject that is close Turn the focusing ring to the right (from ∞ to 0.45) and focus on the clearest subject using the indication signal in the camera, or by checking visually.
- ② To change the focus from a subject that is close to a subject that is far away Turn the focusing ring to the left (from 0.45 to ∞) and focus on the clearest subject by using the indication signal on the camera, or by checking visually.

4. Brightness Control

[Canon / Nikon(Fujifilm) F / Pentax(Samsung GX) K / Sony α / Canon M / Fujifilm X / Sony E / Samsung NX / FT / MFT NX Mount]

- ① Turn the aperture adjustment ring to set the brightness you want. You can set the desired brightness by turning the aperture ring when using the 50 mm F1.4 AS UMC lens.

[Aperture adjustment ring markings]

- ① Canon / Nikon(Fujifilm) F / Sony α / Canon M / Fujifilm X / Sony E / Samsung NX / FT / MFT Mount]

- ② Pentax (Samsung GX) K

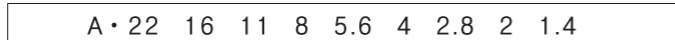

Each number is 1 stop (1 EV) away from the next number. Brightness can be set more precisely by using the stop setting in between. (However, the Sony (Minolta) mount is only controlled in steps of 1 stop)

ex)

1.4 and 2 are 1 stop (1 EV) away from each other.

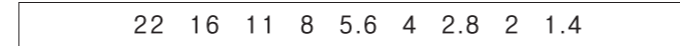

Set a brightness between 1.4 and 2, which is 0.5 of a stop (0.5 EV) between the two

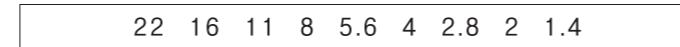

5. Mounting the Hood

The hood has a bayonet system which guarantees speedy, efficient, safe and precise installation, and enables you to enjoy shooting that is free from ghosting or flaring.

[Figure]

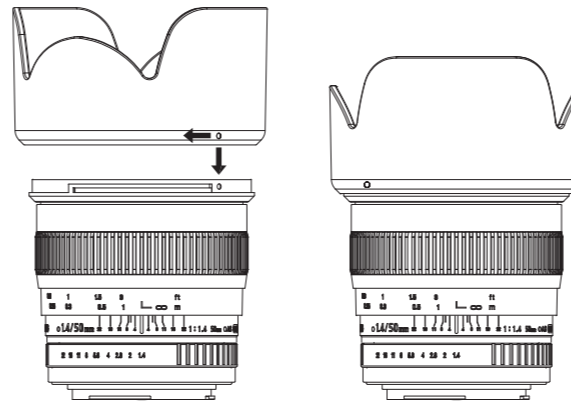

Align the attachment reference point on the hood with the reference point for a hood on the lens, push the hood onto the lens and turn the hood to the right until it makes a clicking sound.

6. About Taking Pictures

The 50 mm F1.4 AS UMC lens supports a maximum brightness of 1.4. If you take a photo in an outdoor place exposed to sunlight, you may not get a clear image because the subject is too bright. Since the depth of focus becomes too shallow at brightness 1.4, if the subject is not focused correctly you may get an unclear image. Therefore, to get a clear image, focus the subject correctly and then take the photo.

7. Camera Settings

Some cameras require special settings when using this lens. Please refer to the following and set the camera when necessary.

○ Canon Mount

The diaphragm of the 50 mm F1.4 AS UMC Canon mount is not compatible with the camera. If the brightness value is set to above F8, the user may have difficulty in setting the correct focus by viewing a subject through the camera viewfinder, therefore focus on a subject with fully opening the aperture when attaching this lens to the camera, and then set the depth of focus and brightness you want to express prior to shooting photo.

- 1) Set the camera mode dial to M.

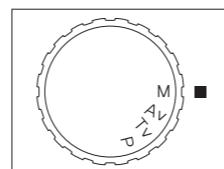

- 2) Adjust the shutter speed to achieve the appropriate exposure for the brightness.

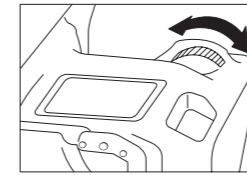

※ For some Canon cameras, if you set the camera mode dial to Av and set the brightness by turning the aperture adjustment ring on the lens, the camera automatically changes the shutter speed. Therefore you don't have to adjust the shutter speed as well, which is required in M mode.

(The procedures above are for the 40D. The settings for the camera or the menu may vary based on the model or due to a functional upgrade. Refer to the camera instruction manual or contact the camera manufacturer for detailed information.)

○ Nikon (Fujifilm) F Mount

The diaphragm of the 50 mm F1.4 AS UMC Nikon mount is not compatible with the camera. If the brightness is set to F8 or above, you may not be able to set the correct focus due to a difficulty in viewing the subject through the camera viewfinder. Turn the aperture ring so it is fully open when attaching the lens to the camera, and then set the depth of field and brightness you want prior to shooting.

○ Pentax (Samsung GX) K Mount

The 50 mm F1.4 AS UMC Pentax (Samsung GX) K Mount supports Av mode.

- 1) Align the A mode indicator to the distance scale indicator mark by pressing the A button on the aperture adjustment ring of the lens.
- 2) Set the mode dial of the camera to Av.

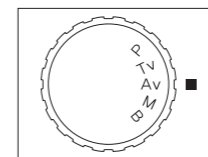

- 3) Set the focusing lever of the camera to MF.

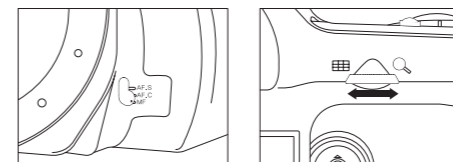

- 4) Set the menu on the camera. User settings ► Use aperture ring ► Prohibition

- 5) Adjust the brightness by turning the dial at the back of the camera.

(The procedures above are for the K20D. The settings for the camera or the menu may vary based on the model or due to a functional upgrade. Refer to the camera instruction manual or contact the camera manufacturer for detailed information.)

○ Sony (Minolta) α Mount

The diaphragm of the 50 mm F1.4 AS UMC Sony (Minolta) α mount is not compatible with the camera. If the brightness value is set to above F8, the user may have difficulty in setting the correct focus by viewing a subject through the camera viewfinder, therefore focus on a subject with fully opening the aperture when attaching this lens to the camera, and then set the depth of focus and brightness you want to express prior to shooting photo.

- 1) Set the camera mode dial to M.

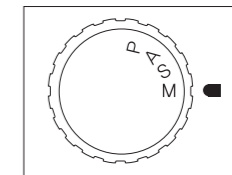

- 2) Set the focusing lever of the camera to MF.

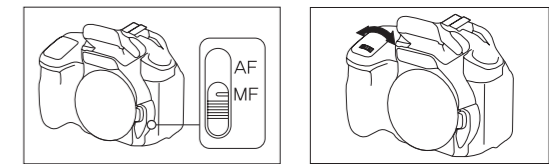

- 3) Adjust the shutter speed to achieve the appropriate exposure for the brightness.

(The above procedure is given based on the α 350. The camera settings are different depending on the model or due to a functional upgrade, therefore refer to the camera manual or contact the camera manufacturer for detailed information.)

○ Konica Minolta (Minolta) DYNA Series

If this lens is used on some Konica Minolta (Minolta) or series cameras, the release lock function (misuse prevention function) of the camera must be disabled. It is required to disable the release lock function only on the first use as below.

Procedure for disabling the release lock function

- ① Set the main switch of the camera to OFF.
- ② Detach the lens from the camera body and set the main switch of the camera to ON by pressing the following two buttons.

9xi...function button +AE lock button 303si...AV button +self mode button
7xi...function button +AE lock button 303si SUPER...drive button +spot button
5xi...function button +spot button 101si...self-timer button+flash button
3xi...modification is required at a service center 360si...self-timer continuous shooting button+scene select button

807si...AEL button + shooting scene select button α -Sweet ... self-timer continuous shooting button
707si...card button + spot button + spot button
507si...lens exchange button + ISO lock button α -Sweet S...(Set the function dial to the multiple exposure)P button + self-timer button
DYNAX3L...shooting scene select button + turn the button away from the OFF. DYNAX30...self-timer button+turn the left dial on the main body away from the OFF.

α ...Sweet | | | L...Set the camera to the custom function 14 and change the selection number 1 to 2 (N.A).

α ...7 -9 -Ti - Set the camera to custom function 16 and change the selection number from 1 to 2 (N.A).

α ...Sweet Digital...Execute the following operation.

MENU \Rightarrow *2 \Rightarrow Release lock with a lens \Rightarrow To the right \Rightarrow N.A \Rightarrow ●Execute \Rightarrow MENU

α ...7 Digital...Execute the following operation.
MENU \Rightarrow *3 \Rightarrow Release lock with a lens \Rightarrow To the right \Rightarrow N.A \Rightarrow ●Execute \Rightarrow MENU

※ If the release lock is disengaged in the above way, the state of disengagement is maintained even though the main switch is turned off. If you want to enable the release lock function, perform the above procedure again.

(The camera settings are different depending on the model or due to a functional upgrade, therefore refer to the camera manual or contact the camera manufacturer for detailed information.)

Mirrorless Cameras (Canon M, Samsung NX, Sony E, Fujifilm X)

The diaphragms of the 50 mm F1.4 AS UMC Canon M, Samsung NX, Sony E, Fujifilm X mounts are not compatible with the cameras. If the brightness is set to F8 or above, you may not be able to set the correct focus due to a difficulty in viewing the subject through the camera viewfinder. Turn the aperture ring so it is fully open when attaching the lens to the camera, and then set the depth of field and brightness you want prior to shooting.

[Canon M Mount]

- 1) Set the exposure to manual exposure (M) and change the focus mode to MF.



(The procedures above are for the Canon M. The settings for the camera or the menu may vary based on the camera model or due to a functional upgrade. Refer to the camera instruction manual or contact the camera manufacturer for detailed information.)

[FUJIFILM X Mount]

- 1) Set the focus mode to M.

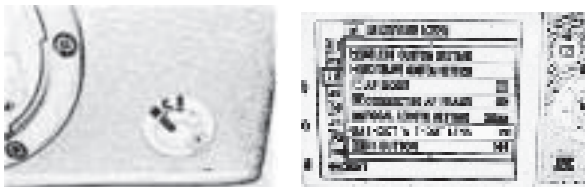

- 2) Press the MENU/OK button, and select ON at 'Shooting without lens' in the shooting menu.(The procedures above are for the X-Pro1. The settings for the camera or the menu may vary based on the camera model or due to a functional upgrade. Refer to the camera instruction manual or contact the camera manufacturer for detailed information.)

[Samsung NX Mount]

- 1) Set the camera mode dial to M.
- 2) Adjust the shutter speed by turning the dial to achieve the appropriate exposure for the brightness.



※ For some Samsung (NX) cameras, if you set the camera mode dial to A and set the brightness by turning the aperture ring on the lens, the camera automatically changes the shutter speed. Therefore you don't need to adjust the shutter speed as well, which is required in M mode.

(The procedures above are for the NX200. The settings for the camera or the menu may vary based on the camera model or due to a functional upgrade. Refer to the camera manual or contact the camera manufacturer for detailed information.)

[Sony E Mount]

- 1) Set the camera mode dial to M.
- 2) Adjust the shutter speed by turning the dial to achieve the appropriate exposure for the brightness.



※ For some Sony E cameras, if you set the camera mode dial to A and set the brightness by turning the aperture ring on the lens, the camera automatically changes the shutter speed. Therefore you don't need to adjust the shutter speed as well, which is required in M mode.

(The procedures above are for the NEX-5. The settings for the camera or the menu may vary based on the model or due to a functional upgrade. Refer to the camera manual or contact the camera manufacturer for detailed information.)

Four Thirds, Micro Four Thirds

50 mm F1.4 AS UMC Four Thirds. The diaphragms of the Micro Four Thirds mounts are not compatible with the cameras.If the brightness is set to F8 or above, you may not be able to set the correct focus due to a difficulty in viewing the subject through the camera viewfinder. Turn the aperture ring so it is fully open when attaching the lens to the camera, and then set the depth of field and brightness you want prior to shooting.

[Four Thirds Mount]

- 1) Hold down the MODE button and turn the dial until it is set to M. (shooting conditions)
MODE + control dial ► M mode setting (manual shooting)

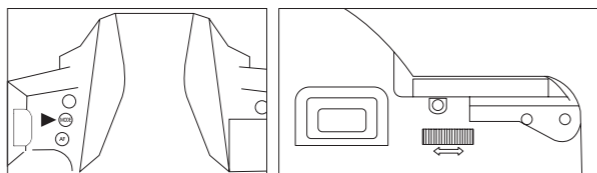

- 2) Hold down the AF button and turn the dial until it is set to MF. (focusing)AF + control dial ► MF setting (manual focusing)

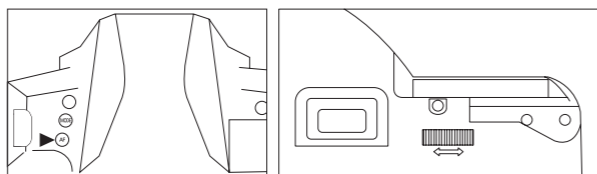

- 3) Adjust the shutter speed to achieve the appropriate exposure for the brightness by turning the dial.

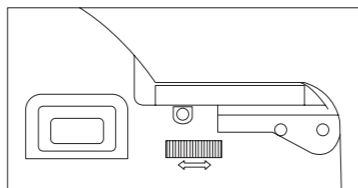

(The procedures above are for the Olympus E-3. The settings for the camera or the menu may vary based on the camera model or due to a functional upgrade. Refer to the camera manual or contact the camera manufacturer for detailed information.)

[Micro Four Thirds Mount]

- 1) Set the camera mode dial to M.

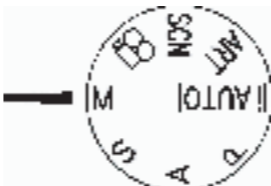

- 2) Adjust the shutter speed by turning the dial to achieve the appropriate exposure for the brightness.

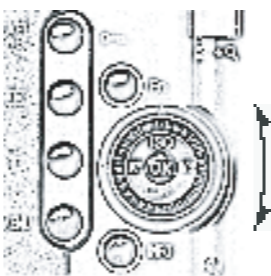

※ For some Olympus (MFT) and Panasonic (MFT) cameras, if you set the camera mode dial to A and set the brightness by turning the aperture adjustment ring on the lens, the camera automatically changes the shutter speed. Therefore you don't need to adjust the shutter speed as well, which is required in M mode.

(The procedures above are for the E-P2. The settings for the camera or the menu may vary based on the camera model or due to a functional upgrade. Refer to the camera manual or contact the camera manufacturer for detailed information.)

8. Specification

SPECIFICATIONS	1:1.4 50mm AS UMC										
APERTURE RANGE (T-STOP) (Brightness)	F1.4 ~ 22										
OPTICAL CONSTRUCTION	9 ELEMENTS IN 6 GROUPS (1 ASPHERICAL & 1 HYBRID LENS)										
MINIMUM FOCUSING DISTANCE	0.45m (1.47ft)										
FILTER SIZE	Ø 77mm										
MAXIMUM DIAMETER	Ø 81.6mm										
MOUNT	CANON EOS	NICON	PENTAX K	SONY α	CANON M	FUJIFILM X	SAMSUNG NX	SONY E	FOUR-THIRDS	MICRO FOUR-THIRDS	
ANGLE OF VIEW	35mm	46.2°	46.2°	46.2°	46.2°	•	•	•	46.2°	•	•
	APS-C	29.0°	30.8°	30.8°	30.8°	29.0°	30.8°	30.8°	30.8°	•	•
	FOUR-THIRD 4/3"	•	•	•	•	•	•	•	•	23.6°	23.6°
LENGTH (LENS MOUNT TO FRONT)	74.7mm	72.2mm	73.2mm	74.2mm	100.6mm	101.0mm	93.2mm	100.7mm	80.0mm	98.5mm	
WEIGHT (CAP, HOOD DETACHABLE)	535g	520g	510g	530g	600g	605g	555g	565g	545g	555g	

9. Trouble-shooting

Issue	Causes	Action
A lens cannot be attached to the camera.	The attachment reference point on the lens is not aligned with the lens attachment reference point on the camera.	Align the attachment reference point on the lens with the lens attachment reference point on the camera.
A lens cannot be detached from the camera.	Incorrect rotation direction for detaching the lens.If you turn the lens while holding the camera, it may cause damage to the lens.	Hold down the lens release button on the camera, gently turn the lens toward the lens attachment/detachment reference point marked on the camera, and then pull the lens away.
Blurry images	Incorrect focusing.Camera shake, or insufficient shutter speed.	Turn the focusing ring while checking the subject using the indicator in the camera or checking visually to set the focus until the subject is clear and distinct, and then press the shutter.After secure a shutter speed of 1/125 secs or faster, steady the camera and take a photograph.
FEE (blinking)	The aperture adjustment ring on the lens is not set to the minimum aperture value.	Turn the aperture adjustment ring to set it to the minimum aperture value. (F22)
Autofocus failure	Autofocus failed with a manual control focus lens.	Set the focus by turning the focusing ring.
The pictures are too dark or too bright.	The exposure is incorrect.	Set the aperture adjustment ring of the lens correctly.
The camera flash is not synchronized to the camera.	With a non-CPU lens, the camera flash may not be geared to some cameras.	See the camera manual.
	This lens corresponds to the Nikon AHP lens.	See the camera manual or flash manual.This lens is not a 'D-type' lens (which relays distance information to the camera).
There is no camera finder indication or display.	This lens doesn't have electronic contacts, so there is no electronic communication with the camera.	No problem with shooting.
Zoom failure.	This lens is a short focus lens.	
The lens can't be attached to other cameras.	This lens is designed for a specific mount type.	Purchase the required lens mount.
You want to attach our 2X or 1.4X converter lens.	Our converter is designed for the T (M42 SCREW) mount only, thus it cannot be used with this 24 mm F1.4 ED AS IF UMC lens.	You can use each company's own mount converter.However, be aware that auto focusing is unavailable.

10. Safety Precautions

The following precautions are divided into two types according to the level of danger.

Warning

If this instruction is not followed, it may cause death or severe injury to the user.

⚠ Don't look at the sun through the lens.U may cause blindness.

⚠ Keep the lens out of children's reach. It may drop or fall down, causing injury.

Caution

If this instruction is not followed, it may cause damage or injury to the user.

⚠ Attach the lens to the camera correctly and make sure that the lens is attached firmly. If the lens is not attached correctly, it may not be pulled out or it may fall down, causing injury.

⚠ Do not modify or alter the lens.U may lead to failure of the camera. Modified or altered lenses may not be repaired.

⚠ Don't leave the lens in direct sunlight. It may cause a fire, depending on lenses that concentrate light on a close object.

The following pictograms are used in the below precautions:

⚠ Requires caution. Inside the pictogram it shows contents of precautions. (The pictogram on the left shows the caution for ignition.)

⊘ Shows prohibition. Inside the pictogram it shows contents of prohibition. (The pictogram on the left shows the prohibition of disassembly.)

📖 Shows instruction. Inside the pictogram it shows contents of instructions. (It shows instruction of precaution in the pictogram on the left.)

⚠ Ensure the camera operates properly by checking the lens beforehand or by test shooting for important events such as a wedding ceremony and an overseas trip.

⚠ Don't look at the sun directly through a camera with a lens attached. It may cause damage to one's eyesight.

WARNING!
Do not wet this product or expose it to a moist environment. It may cause a fire or electric shock.

CAUTION!

- Don't use this product or store it close to devices that generate heat i.e., heaters, thermal regulators, stoves, stereo amplifiers.
- Do not expose the lens to drastic temperature changes.
- Do not touch the surface of the lens with your hand, or let it come into contact with sharp objects.
- Do not drop the lens.
- Do not soak the lens in water, and avoid water splashing onto the lens.
- If there are foreign bodies on the lens, use a lens cleaning kit only.

