

Mi Smart LED Desk Lamp Pro User Manual

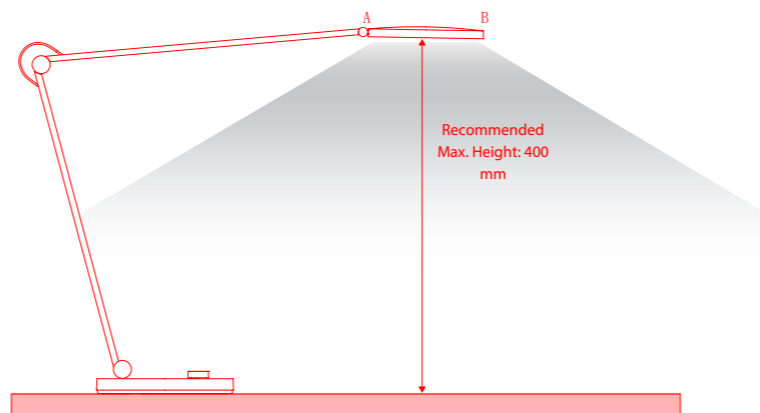

Read this manual carefully before use, and retain it for future reference.

Product Overview



Recommended
Max. Height: 400
mm

Thank you for using the Mi Smart LED Desk Lamp Pro. Equipped with high-quality LEDs, the lamp features a professional optical design using a natural light mixing algorithm to deliver a uniform lighting experience. Structurally, it adopts a multi-angle adjustable design for a professional and comfortable lighting performance.

This lamp is intended for use in studies, bedrooms, and other indoor areas. Under normal usage conditions, the lamp should be positioned so that the direction of the lamp head (indicated by points A and B) is parallel to the desktop. When the light emitting surface is level, the vertical distance between it and the desktop is 400 mm.

01

Using the Lamp

Connect to Power Supply

Plug the power cable into the charging port at the base and connect the adapter to a power supply.

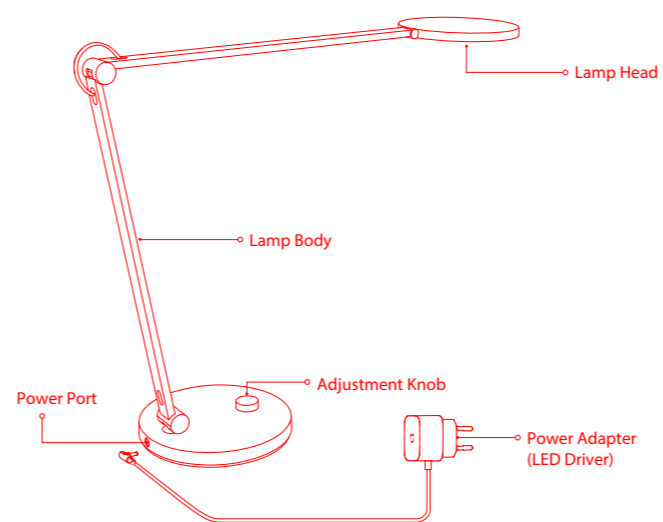

02

Button Instructions

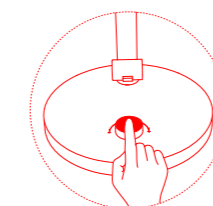

Press down on the knob once to turn the lamp on or off.

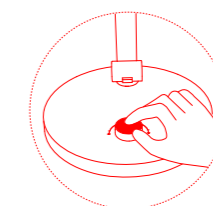

Turn the knob to adjust the lamp's brightness.

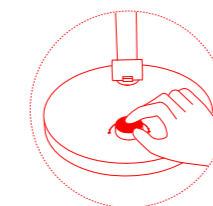

Hold the knob down and turn it to adjust the lamp's color temperature.

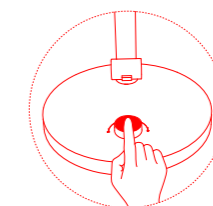

Double press the knob to enable reading mode. (Can be customized in the app)

03

Angle Adjustment

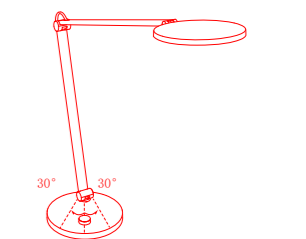
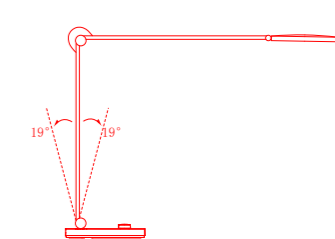
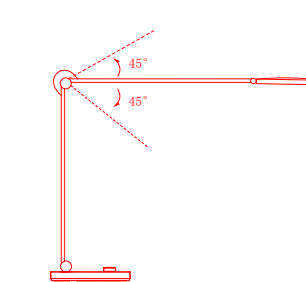
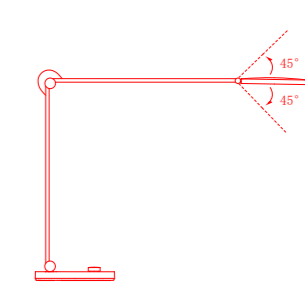

04

Connecting with Mi Home / Xiaomi Home App

This product works with Mi Home / Xiaomi Home app *. Control your device, and interact it and other smart home devices with Mi Home / Xiaomi Home app.

Scan the QR code to download and install the app. You will be directed to the connection setup page if the app is installed already. Or search "Mi Home / Xiaomi Home" in the app Store to download and install it.

Open Mi Home / Xiaomi Home app, tap "+" on the upper right, and then follow prompts to add your device.



* The app is referred to as Xiaomi Home app in Europe (except for Russia). The name of the app displayed on your device should be taken as the default.

Note: The version of the app might have been updated, please follow the instructions based on the current app version.

Apple HomeKit Smart Control

1. Open the Home app on your iPhone or iPad.
2. Tap "Add Accessories" and follow the instructions in the app to scan the QR code on the product base, or enter the 8-digit setup code above the QR code to grant the Apple Home app access.

* Make sure a Wi-Fi network with Internet access is available (this product does not support 5G networks).

To control this HomeKit-compatible accessory, it is recommended that you use iOS 9.0 or above.

The HomeKit setup code is listed on the product base, do not lose it.

After restoring factory settings, you will need the HomeKit setup code again to add the accessory.

iPad and iPhone are the trademarks of Apple Inc., and they are registered in the United States and other countries.

05

Link a Lamp with Google Assistant

Add the Mi Home / Xiaomi Home service to the Google Assistant app, to control devices connected to Mi Home / Xiaomi Home from Google Assistant.

1. Tap in the Google Assistant app, search for "Mi Home / Xiaomi Home", tap "Link", and sign in with your Xiaomi account.
2. Tap in Settings > Home control to add a device, and follow the on-screen instructions. Once the accounts are linked, you can control the Lamp from Google Assistant.

Link a Lamp with Amazon Alexa

Add the Mi Home / Xiaomi Home skill to the Amazon Alexa app, to control devices connected to Mi Home / Xiaomi Home from Amazon Alexa.

1. Tap in the Amazon Alexa app, then tap "Skills & Games", search for "Mi Home / Xiaomi Home", select the correct skill and tap "Enable". Then sign in with your Xiaomi account.
2. After successfully linking the accounts, tap DISCOVER DEVICES to add the device, and follow the on-screen instructions. Once the accounts are linked, you can control the Lamp from Amazon Alexa.

Note: The name (Mi Home or Xiaomi Home) varies by selected language or regions.

06

Restoring Factory Settings

The reset button is at the bottom of the lamp base. When the lamp is on, insert a straightened tool into the hole for 5 seconds, and release it when the light starts blinking slowly. The reset completes when the blinking stops.

Note: To use the lamp in a different network environment, restore it to the factory settings before connecting to the new network.

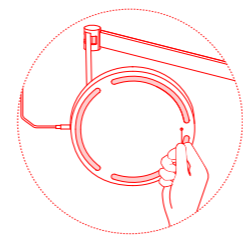

Specifications

| | |
|---|--|
| Model: MJTD02YL | Operating Temperature: -10°C to 35°C |
| Power Factor: 0.5 | Operating Humidity: 0-85% RH |
| Color Rendering Index: Ra90 | Rated Power: 14 W (Lamp + LED Driver) |
| Service Life: Approx. 25000 h | Rated Input: 220-240 V~50/60 Hz 0.45 A |
| Operating Frequency: | Lamp Input: 12 V = 1.0 A |
| 2412-2472 MHz (Wi-Fi) | Compatible with: Android 4.4 or iOS 9.0 and above |
| 2402-2480 MHz (BT) | Wireless Connectivity: Wi-Fi IEEE 802.11 b/g/n 2.4 GHz |
| Maximum Output Power: 17.70 dBm (Wi-Fi) | 4.19 dBm (BT) |

07

Product Features



Color Temperature Adjustment



Brightness Adjustment



Flicker Free



Low Blue Light Content



Scheduled On/Off



Large Area Lighting



Multi-angle Adjustment



High Color Rendering Index



Reading Mode



PC Mode



Child Mode



Focus Mode



Mi Home/Xiaomi Home App*



Apple HomeKit



Turn-off Delay



Firmware Update

08

Warning

- Suitability for use "indoors", the related ambient temperature is 35°C.
- Please use the power resource correctly in the door.
- If in any doubt, consult a qualified electrician.
- Do not put the luminaire on the inclined plane.
- For indoor use only.
- Class III Luminaire.
- If the power cord is damaged, it must be replaced by the manufacturer or a qualified service engineer to avoid any risks to safety.
- The light source contained in this luminaire shall only be replaced by the manufacturer or his service agent or a similar qualified person.
- Do not disassemble the product. The light-emitting diode may cause damage to your eyes.
- Under normal use of condition, this equipment should be kept a separation distance of at least 20cm between the antenna and the body of the user.

09

EU Declaration of Conformity

Hereby, Qingdao Yeelink Information Technology Co., Ltd., declares that the radio equipment type MJTD02YL is in compliance with Directive 2014/53/EU. The full text of the EU declaration of conformity is available at the following internet address: <https://www.mi.com/en/service/support/declaration.html>.

WEEE Disposal and Recycling

All products bearing this symbol are waste electrical and electronic equipment (WEEE as in directive 2012/19/EU) which should not be mixed with unsorted household waste. Instead, you should protect human health and the environment by handing over your waste equipment to a designated collection point for the recycling of waste electrical and electronic equipment, appointed by the government or local authorities. Correct disposal and recycling will help prevent potential negative consequences to the environment and human health. Please contact the installer or local authorities for more information about the location as well as terms and conditions of such collection points.

10