

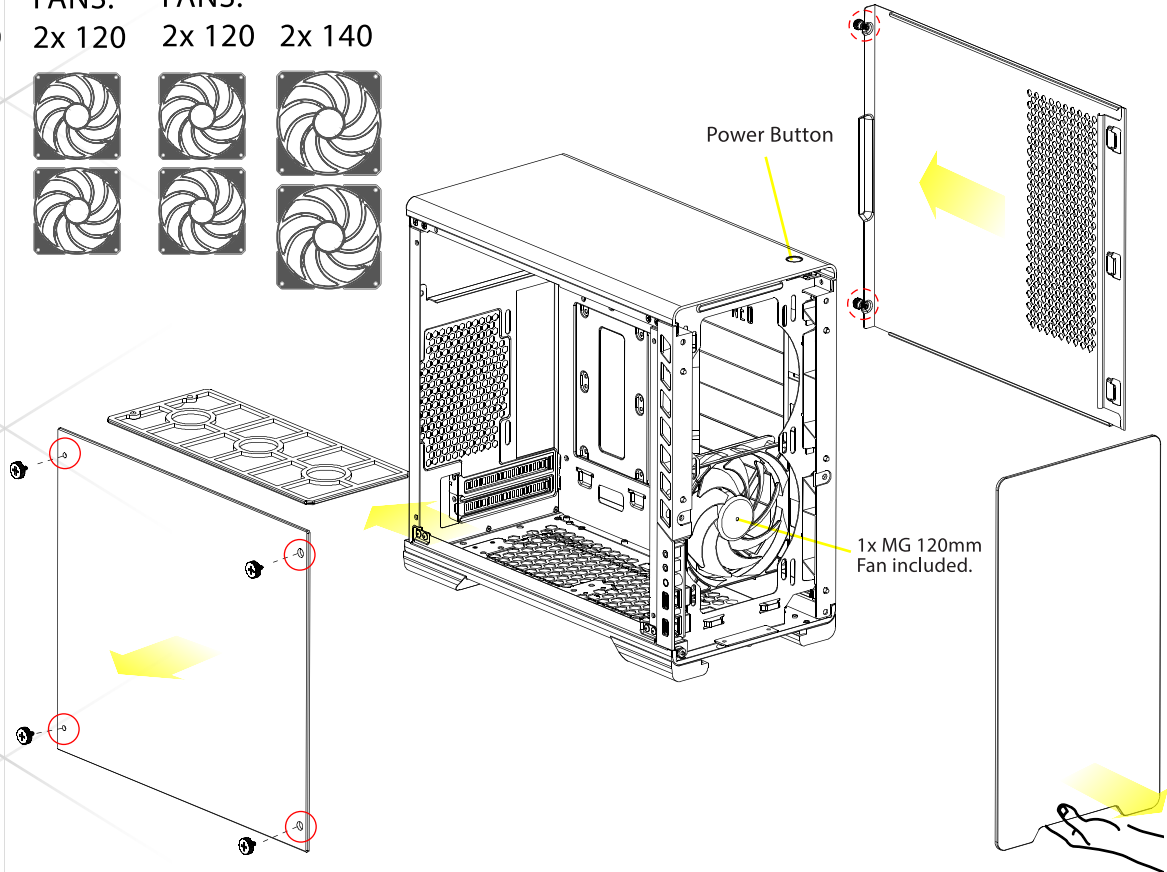

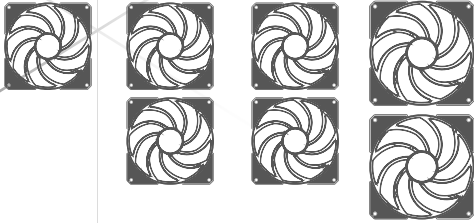



Thank you for choosing the MG NEO-Mini chassis. Take your time reading this manual before installing your system.

Check www.metallicgear.com for the latest information and manual version.

REAR FANS: 1x 120
SIDE FANS: 2x 120
FRONT FANS: 2x 120 2x 140



ACCESSORIES

-  13x Motherboard M3 screws
-  4x PSU 6-32 screws
-  8x Fans screws
-  4x HDD 6-32 screws
-  6x Zip ties

CLEARANCES

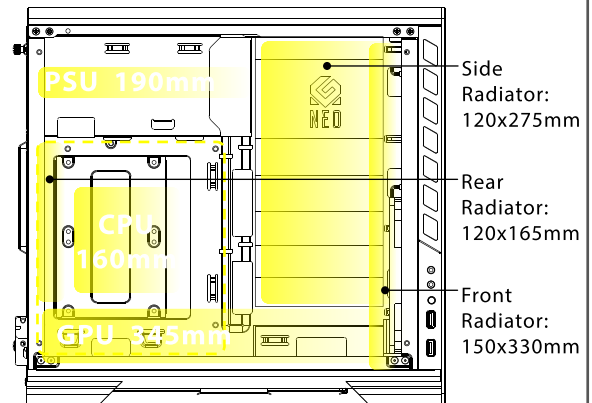

HARDWARE INSTALLATION

MOTHERBOARD

4x 

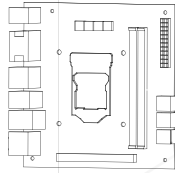

Supports:
mini-ITX

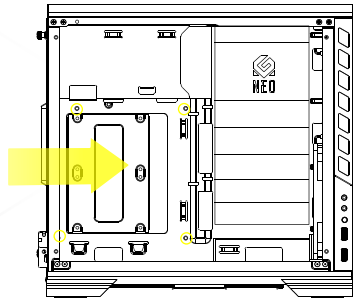

POWER SUPPLY

4x 

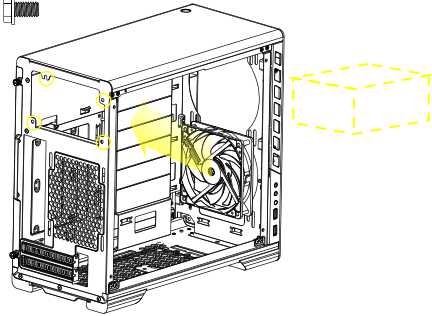

SSD

4x 

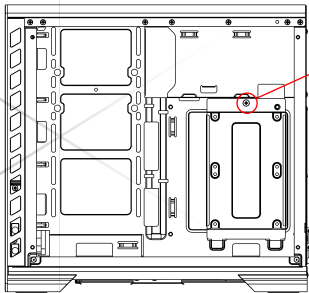

Remove SSD bracket.

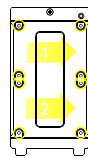

HDD

4x  / 8x 

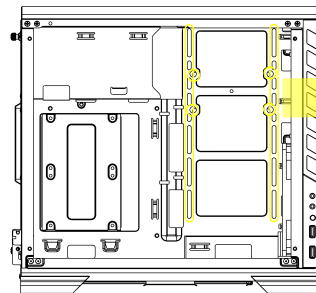

Remove Cover.

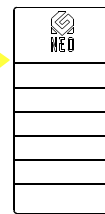

CABLE MANAGEMENT

Use the velcro straps and zip ties to route all of the cables.

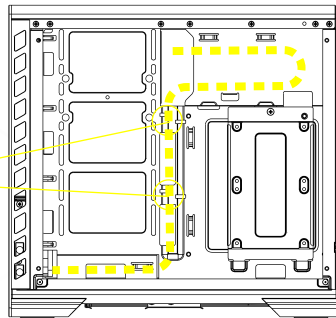
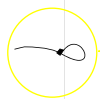

FRONT I/O CABLES

Connect to
Motherboard

Connect to
Power Supply

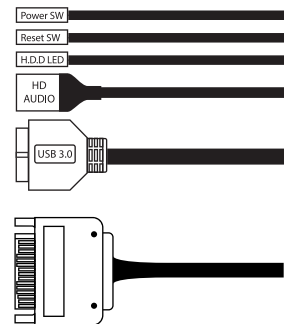

RGB-LIGHTING CONTROLS

RGB CABLES

Daisy-chain RGB Products



To Motherboard RGB Header





RGB CONTROL

- **Short Press** to change color:



- **Long Press** to change mode:

-  Solid
-  Breathing
-  Color Cycle

- **Press and Hold** to turn off or switch to motherboard control.

RGB-Control Button

