

Halfpipe Single Trailer

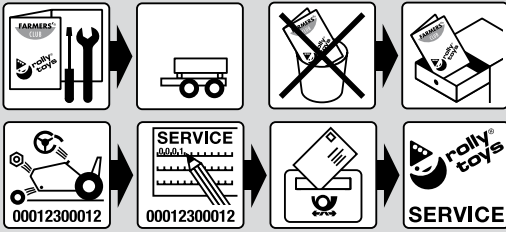
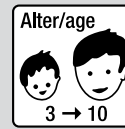

rally toys Kundendienst Deutschland:

Tel: +49 (0) 95 68 / 856-142

Fax: +49 (0) 95 68 / 856-183

e-mail: service@rallytoys.de

2018/01

319.000.799.00

- **
- +10
- +12
- +13
- +20
- +22
- +23
- +26
- +30
- +37
- +40
- +41
- +44
- +47
- +51
- +54
- +70
- +75
- +80

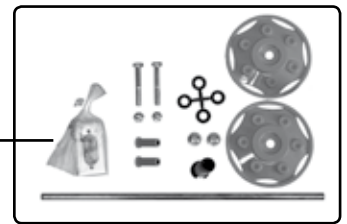
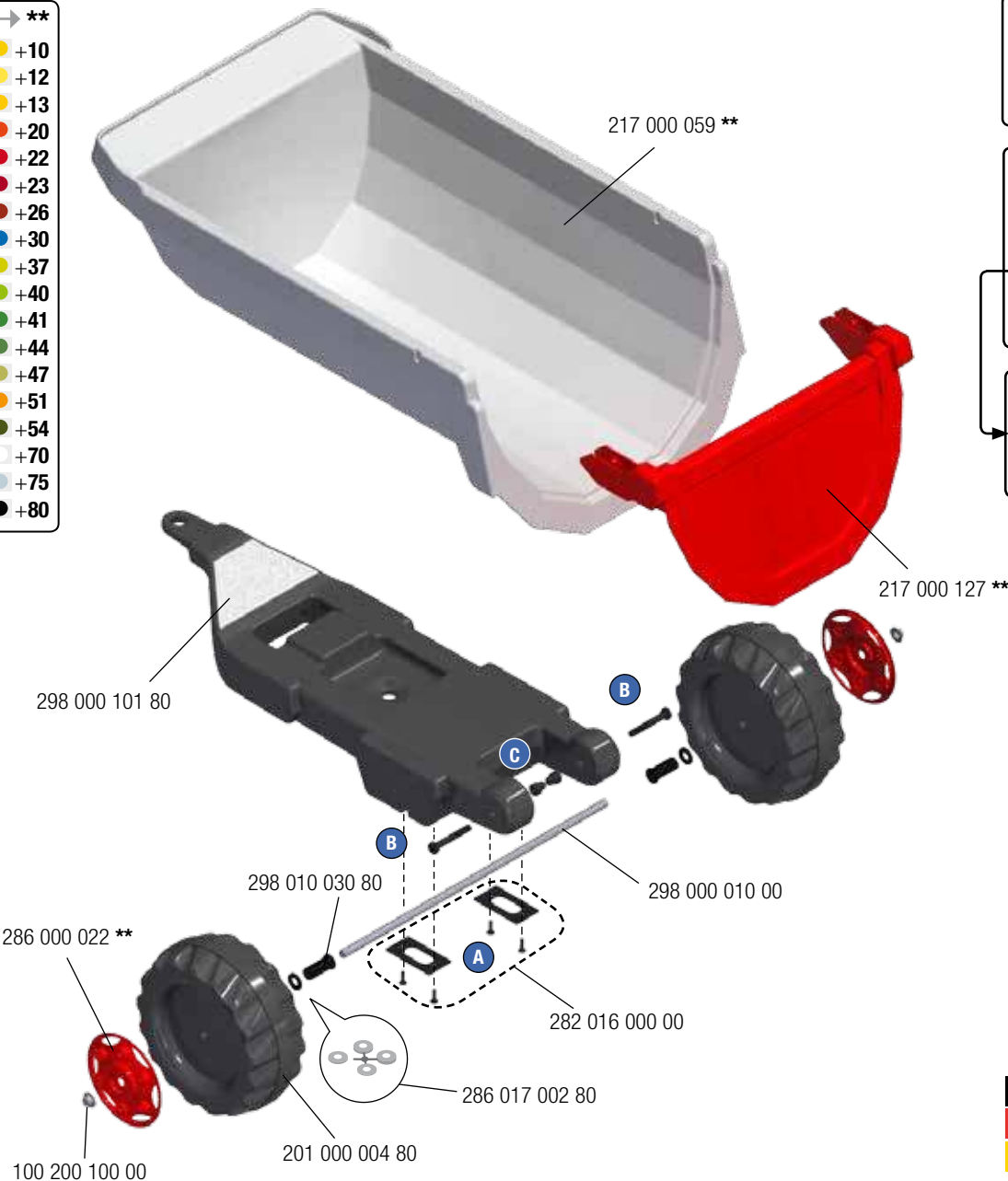

made in Germany



---NORTH & SOUTH AMERICA only---

180 days warranty

From the date of purchase + guaranteed spare part service

The warranty does not cover damages caused by improper use or neglect



Franz Schneider GmbH & Co KG

P.O.Box 1460

D-96459 - Neustadt bei Coburg - Germany

Tel.: +49 (0) 95 68 / 856-0

Fax.: +49 (0) 95 68 / 856-190

www.rallytoys.com

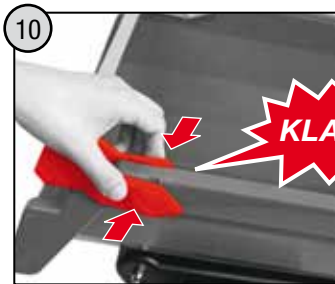
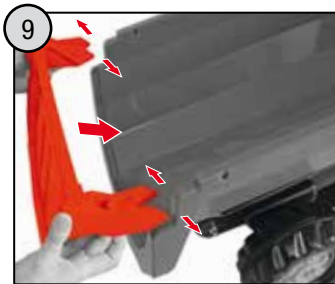
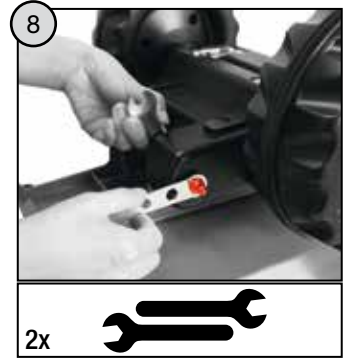
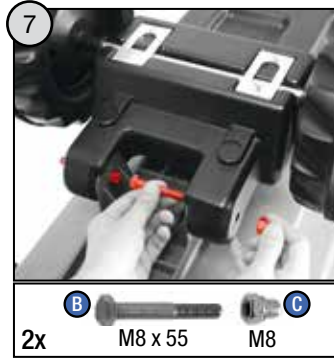
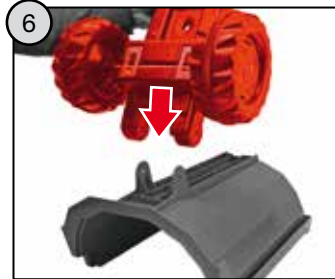
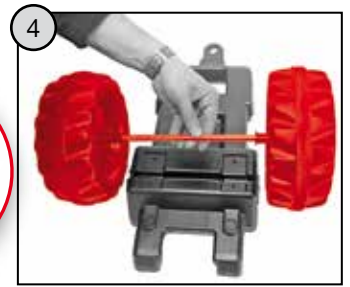
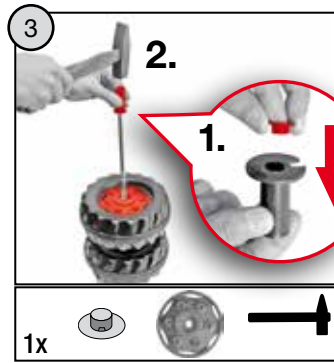
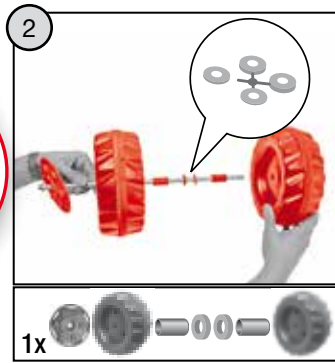
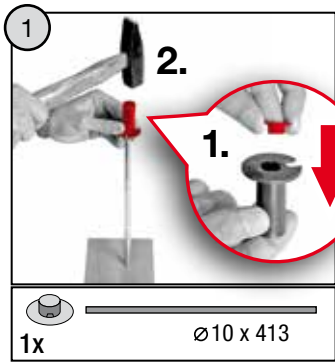

⚠ WARNING

- CHOKING HAZARD - Small parts, Danger of being swallowed. Contains small parts in non assembled state. Must be assembled by adults.
- Toy is not suitable to carry children.
- If toy is defective stop using it, repairs may only be carried out by adults.
- Adult supervision required.
- Never use near steps, slopes, driveways, hills, roadways, alleys or swimming pool areas.
- Always wear shoes.
- Conforms to the requirements of ASTM Standard Consumer Safety Specification on Toy Safety, F 963.

←		
<input type="checkbox"/>	rolly Dreiradtraktoren	05 ●●●
<input type="checkbox"/>	rollyMinitrac	13 ●●●
<input type="checkbox"/>	rollyKid	01 ●●● / 02 ●●●
<input checked="" type="checkbox"/>	rollyJunior	80 ●●● / 81 ●●●
<input checked="" type="checkbox"/>	rollyFarmtrac	60 ●●● / 61 ●●●
<input checked="" type="checkbox"/>	rollyFarmtrac Classic	03 ●●● / 04 ●●●
<input checked="" type="checkbox"/>	rollyFarmtrac Premium	70 ●●● / 71 ●●●
<input checked="" type="checkbox"/>	rollyX-Trac	03 ●●● / 04 ●●●
<input checked="" type="checkbox"/>	rollyTruck (Unimog)	03 ●●●

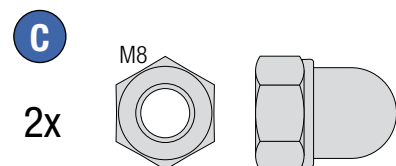
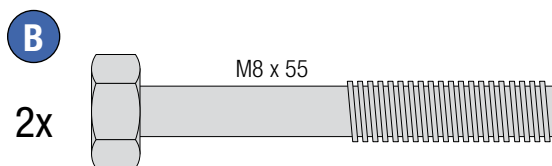
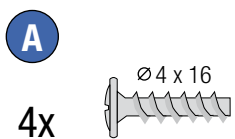

(metrisch • metric)