



# EMC TEST REPORT

For

Shenzhen Siyoteam Technology Co., Ltd

Product Name: TRAVEL CHARGER

Model No.: A1301Q

Prepared for : Shenzhen Siyoteam Technology Co., Ltd  
Address : Room 2003B, SEG Plaza, huaqiang North Road, Futian District,  
shenzhen, PR.China

Prepared by : SHENZHEN POCE TECHNOLOGY CO., LTD.  
Address : H Building, Hongfa Science and Technology Park, Tangtou,  
Shiyan, Bao'an District, Shenzhen, China

Report No. : POCE17110613HRE  
Date of Receiver : Nov. 06, 2017  
Number of tested samples : 1  
Serial number : Prototype  
Date of Test : Nov. 06, 2017 – Nov. 13, 2017  
Date of Report : Nov. 13, 2017

**Note:** This test report is limited to the above client company and the product model only. It may not be duplicated without prior written consent of Shenzhen POCE Technology Co., Ltd

## TABLE OF CONTENT

Description	Page
Test Report Description	
<b>1. GENERAL INFORMATION .....</b>	<b>4</b>
1.1. Description of Device (EUT).....	4
1.2. Test Standards .....	5
1.3. Test Methodology .....	5
1.4. Test Facility .....	5
<b>2. MEASURING DEVICE AND TEST EQUIPMENT .....</b>	<b>6</b>
2.1. For Power Line Conducted Emission .....	6
2.2. For Radiated Emission Measurement .....	6
2.3. For Harmonic Current / Flicker Measurement.....	6
2.4. For Electrostatic Discharge Immunity Test .....	6
2.5. For RF Strength Susceptibility Test .....	6
2.6. For Electrical Fast Transient /Burst Immunity Test.....	7
2.7. For Surge Immunity Test.....	7
2.8. For Injected Current Susceptibility Test.....	7
2.9. For Magnetic Field Immunity Test.....	7
2.10. For Voltage Dips and Interruptions Test.....	7
<b>3. POWER LINE CONDUCTED EMISSION MEASUREMENT .....</b>	<b>8</b>
3.1. Block Diagram of Test Setup .....	8
3.2. Measuring Standard .....	8
3.3. EUT Configuration on Measurement.....	8
3.4. Test Procedure .....	8
<b>4. RADIATED EMISSION MEASUREMENT.....</b>	<b>11</b>
4.1. Block Diagram of Test .....	11
4.2. Measuring Standard .....	11
4.3. EUT Configuration on Test.....	11
4.4. Test Procedure .....	12
<b>5. HARMONIC CURRENT EMISSION MEASUREMENT.....</b>	<b>15</b>
5.1 Block Diagram of Test Setup .....	15
5.2 Measuring Standard.....	15
5.3 Description of test Equipment.....	15
<b>6. VOLTAGE FLUCTUATION AND FLICKER MEASUREMENT.....</b>	<b>16</b>
6.1 Block Diagram of Test Setup .....	16
6.2 Measuring Standard .....	16
<b>7. ELECTROSTATIC DISCHARGE IMMUNITY TEST .....</b>	<b>18</b>
7.1 Block Diagram of Test Setup .....	18
7.2 Test Standard .....	18
7.3 Severity Levels and Performance Criterion .....	18
7.4 Test Procedure .....	19
<b>8. RF FIELD STRENGTH SUSCEPTIBILITY TEST .....</b>	<b>21</b>
8.1 Block Diagram of Test .....	21
8.2 Test Standard.....	21
8.3 Severity Levels and Performance Criterion.....	22
8.4 Test Procedure .....	22
<b>9. ELECTRICAL FAST TRANSIENT/BURST IMMUNITY TEST .....</b>	<b>24</b>
9.1 Block Diagram of Test Setup .....	24
9.2 Test Standard .....	24
9.3 Severity Levels and Performance Criterion .....	24

---

9.4 Test Procedure .....	24
<b>10. SURGE IMMUNITY TEST.....</b>	<b>27</b>
10.1 Block Diagram of Test Setup .....	27
10.2 Test Standard .....	27
10.3 Severity Levels and Performance Criterion .....	27
10.3 Test Procedure .....	28
<b>11. INJECTED CURRENTS SUSCEPTIBILITY TEST.....</b>	<b>30</b>
11.1 Block Diagram of Test Setup.....	30
11.2 Test Standard .....	30
11.3 Severity Levels and Performance Criterion.....	30
11.4 Test Procedure .....	31
<b>12. MAGNETIC FIELD SUSCEPTIBILITY TEST .....</b>	<b>33</b>
12.1 Block Diagram of Test .....	33
12.2 Test Standard .....	33
12.3 Severity Levels and Performance Criterion .....	33
12.4 Test Procedure .....	33
<b>13. VOLTAGE DIPS AND INTERRUPTIONS TEST .....</b>	<b>35</b>
13.1 Block Diagram of Test Setup .....	35
13.2 Test Standard .....	35
13.3 Severity Levels and Performance Criterion .....	36
13.4 Test Procedure .....	36
<b>14. PHOTOGRAPH .....</b>	<b>38</b>
14.1 Photo of Conducted Emission .....	38
14.2 Photo of Radiated Emission .....	38
<b>Appendix.....</b>	<b>39</b>

## 1. GENERAL INFORMATION

### 1.1. Description of Device (EUT)

EUT : TRAVEL CHARGER  
 Trade Name : N/A  
 Model : A1301Q, A1302Q, A2502Q  
 Supplementary Model : Remark: All tests were based on A1301Q.

Test Voltage : AC 230V/50Hz  
 Rating : Input: AC 100 ~ 240V, 50/60Hz, 600mA  
 Output: DC 3.6 ~ 6V, 3A  
 Output: DC 6 ~ 9V, 2A  
 Output: DC 9 ~ 12V, 1.5A

Applicant : Shenzhen Siyoteam Technology Co., Ltd  
 Address : Room 2003B, SEG Plaza, huaqiang North Road, Futian District, shenzhen, PR.China  
 Manufacturer : Shenzhen Siyoteam Technology Co., Ltd  
 Address : Room 2003B, SEG Plaza, huaqiang North Road, Futian District, shenzhen, PR.China

Test Standards : EN 55032:2015  
 EN 55024:2010+A1:2015  
 EN61000-3-2:2014  
 EN61000-3-3:2013

Date of Receiver : Nov. 06, 2017  
 Date of Test : Nov. 06, 2017–Nov. 13, 2017

Test Engineer :   
 Reviewed By: 

## 1.2. Test Standards

- √ Indicates that the test is applicable  
 × Indicates that the test is not applicable

Standard	Test Items	Status
EN 55032:2015	Disturbance Voltage at The Mains Terminals (150KHz To 30MHz)	√
	Radiated Disturbances (30MHz To 1000MHz)	√
EN61000-3-2:2014	Harmonic Current	×
EN61000-3-3:2013	Voltage Fluctuations	√
EN61000-4-2:2009	Electrostatic discharge Immunity	√
EN61000-4-3:2006	Radiated Susceptibility (80MHz to 1GHz)	√
EN61000-4-4:2012	Electrostatic Fast Transient/Burst Immunity	√
EN61000-4-5:2014	Surge Immunity	√
EN61000-4-6:2014	Conducted Susceptibility (150KHz to 80MHz)	√
EN61000-4-8:2010	Power Frequency Magnetic Field Immunity (50/60Hz)	√
EN61000-4-11:2004	Voltage Dips Short Interruptions Immunity Tests	√

## 1.3. Test Methodology

All measurements contained in this report were conducted with CISPR 16-1, radio disturbance and immunity measuring apparatus, and CISPR16-2, Method of measurement of disturbances and immunity.

All measurement required was performed at laboratory of Shenzhen POCE Technology Co., Ltd., at H Building, Hongfa Science and Technology Park, Tangtou, Shiyan, Bao'an District, Shenzhen, China

## 1.4. Test Facility

The test facility is recognized, certified, or accredited by the following organizations:

### **FCC – Registration No.: 222278**

EMC Laboratory has been registered and fully described in a report filed with the (FCC) Federal Communications Commission. The acceptance letter from the FCC is maintained in our files. Registration 222278.

The facility also complies with the radiated and AC line conducted test site criteria set forth in CISPR 16-1, CISPR16-2.

## 2. MEASURING DEVICE AND TEST EQUIPMENT

### 2.1. For Power Line Conducted Emission

Item	Equipment	Manufacturer	Model No.	Factory Number	Last Cal.
1.	Test Receiver	Rohde & Schwarz	ESPI TEST RECEIVER	ID:1164.6607K03-102109-MH	Dec. 28, 2016
2.	L.I.S.N	Rohde & Schwarz	ESH3-Z5.831.5518.52	9561-G071	Dec. 28, 2016
3.	50ΩCoaxial Switch	Anritsu	MP59B	M20531	N/A
4.	Pulse Limiter	SCHWARZ BECK	VTSD 9561-F Pulse limiter 10dB Ateennator	561-G071	Dec. 28, 2016
5.	Cable	SCHWARZ BECK	N/A	N/A	Dec. 28, 2016

### 2.2. For Radiated Emission Measurement

Item	Equipment	Manufacturer	Model No.	Factory Number	Last Cal.
1.	Test Receiver	Rohde & Schwarz	ESPI TEST RECEIVER	ID:1164.6607K03-102109-MH	Dec. 28, 2016
2.	Bilog Antenna	Sunol Sciences	Model JB6 Antenna	A090414	Dec. 28, 2016
3.	50ΩCoaxial Switch	Anritsu	MP59B	M20531	N/A
4.	control	Positioning Controller	Model MF-7802	MF780208362	Dec. 28, 2016
5.	Cable	SCHWARZ BECK	N/A	N/A	Dec. 28, 2016
6.	Cable	SCHWARZ BECK	N/A	N/A	Dec. 28, 2016

### 2.3. For Harmonic Current / Flicker Measurement

Item	Equipment	Manufacturer	Model No.	Factory Number	Last Cal.
1.	Coupling decoupling network	SCHAFFNER	M016	20812	Dec. 28, 2016
2.	PC	N/A	P2L97	N/A	Dec. 28, 2016

### 2.4. For Electrostatic Discharge Immunity Test

Item	Equipment	Manufacturer	Model No.	Factory Number	Last Cal.
1.	ESD Tester	Prima	ESD61002A	144305	Dec. 28, 2016

### 2.5. For RF Strength Susceptibility Test

Item	Equipment	Manufacturer	Model No.	Factory Number	Last Cal.
1.	Signal	HP	8648A	3625U00573	Dec. 28, 2016

	Generator				
2.	Amplifier	AR	500A100	17034	NCR
3.	Amplifier	AR	100W/1000M1	17028	NCR
4.	Isotropic Field Monitor	AR	FM2000	16829	NCR
5.	Isotropic Field Probe	AR	FP2000	16755	Dec. 28, 2016
6.	Biconic Antenna	EMCO	3108	9507-2534	NCR
7.	Log-periodic Antenna	AR	AT1080	16812	NCR
8.	PC	N/A	486DX2	N/A	N/A

## 2.6. For Electrical Fast Transient /Burst Immunity Test

Item	Equipment	Manufacturer	Model No.	Factory Number	Last Cal.
1.	Burst Tester	HTEC	HEFT 51	144303	Dec. 28, 2016
2.	Coupling Clamp	HTEC	IP-4A	147147	Dec. 28, 2016

## 2.7. For Surge Immunity Test

Item	Equipment	Manufacturer	Model No.	Factory Number	Last Cal.
1.	Surge Tester	HTEC	HCWG	144302	Dec. 28, 2016

## 2.8. For Injected Current Susceptibility Test

Item	Equipment	Manufacturer	Model No.	Factory Number	Last Cal.
1.	Simulator	EMTEST	CWS500C	0900-12	Dec. 28, 2016
2.	CDN	EMTEST	CDN-M2	5100100100	Dec. 28, 2016
3.	CDN	EMTEST	CDN-M3	0900-11	Dec. 28, 2016
4.	Injection Clamp	EMTEST	F-2031-23MM	368	Dec. 28, 2016
5.	Attenuator	EMTEST	ATT6	0010222A	Dec. 28, 2016

## 2.9. For Magnetic Field Immunity Test

Item	Equipment	Manufacturer	Model No.	Factory Number	Last Cal.
1.	Magnetic Field Tester	HTEC	HPFM T	144301	Dec. 28, 2016

## 2.10. For Voltage Dips and Interruptions Test

Item	Equipment	Manufacturer	Model No.	Factory Number	Last Cal.
1.	Dips Tester	HTEC	HPFS	144304	Dec. 28, 2016

### 3. POWER LINE CONDUCTED EMISSION MEASUREMENT

#### 3.1. Block Diagram of Test Setup

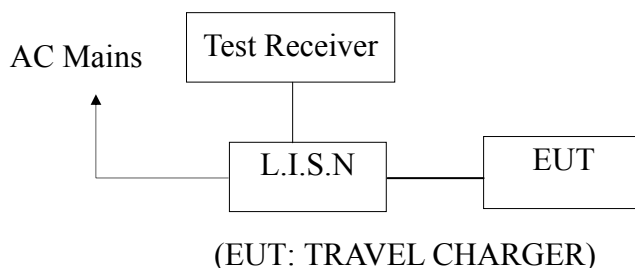

#### 3.2. Measuring Standard

EN 55032:2015

Power Line Conducted Emission Limits (Class B)

Frequency (MHz)	Limit (dB $\mu$ V)	
	Quasi-Peak Level	Average Level
0.15 ~ 0.50	66.0 ~ 56.0 *	56.0 ~ 46.0 *
0.50 ~ 5.00	56.0	46.0
5.00 ~ 30.00	60.0	50.0

NOTE1-The lower limit shall apply at the transition frequencies.  
NOTE2-The limit decreases linearly with the logarithm of the frequency in the range 0.15MHz to 0.50MHz.

#### 3.3. EUT Configuration on Measurement

The following equipments are installed on Conducted Emission Measurement to meet EN 55032 requirements and operating in a manner which tends to maximize its emission characteristics in a normal application.

#### 3.4. Test Procedure

The EUT is put on the plane 0.8m high above the ground by insulating support and connected to the AC mains through Line Impedance Stability Network (L.I.S.N). This provided a 50ohm coupling impedance for the tested equipments. Both sides of AC line are investigated to find out the maximum conducted emission according to the EN 55032 regulations during conducted emission measurement.

The bandwidth of the field strength meter (R&S Test Receiver ESCS30) is set at 9KHz in 150KHz~30MHz and 200Hz in 9KHz~150KHz.

The frequency range from 150kHz to 30MHz is investigated .

Conduction Uncertainty:  $U_c = \pm 2.72$  dB



### Conducted Emission Test Data

EUT	: TRAVEL CHARGER	Temperature:	20°C
M/N	: A1301Q	Humidity :	50%
Test Voltage	: AC 230V/50Hz	Test Mode :	Full load
Test Engineer	: Bill	Phase :	L-Line

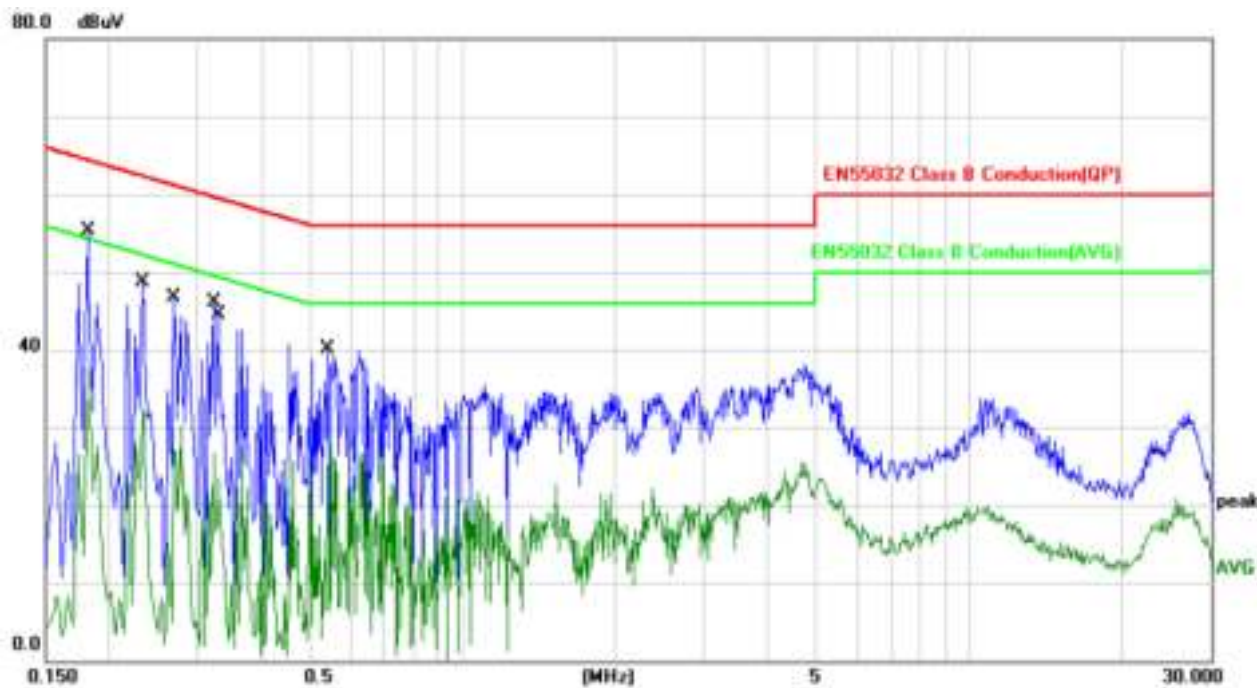

No.	Mk.	Freq. MHz	Reading Level uDuV	Correct Factor uD	Measurement uDuV	Limit uDuV	Over uD	Detector	Comment
1	*	0.1819	55.11	0.19	55.30	64.39	-9.09	QP	
2		0.1819	37.60	0.19	37.79	54.39	-16.60	AVG	
3		0.2340	48.47	0.20	48.67	62.30	-13.63	QP	
4		0.2340	32.05	0.20	32.25	52.30	-20.05	AVG	
5		0.2700	46.44	0.25	46.69	61.12	-14.43	QP	
6		0.2700	26.77	0.25	27.02	51.12	-24.10	AVG	
7		0.3220	45.84	0.31	46.15	59.65	-13.50	QP	
8		0.3220	26.30	0.31	26.61	49.65	-23.04	AVG	
9		0.3300	44.17	0.32	44.49	59.45	-14.96	QP	
10		0.3300	22.53	0.32	22.65	49.45	-26.60	AVG	
11		0.5420	39.82	0.32	40.14	55.00	-15.86	QP	
12		0.5420	28.30	0.32	28.52	45.00	-17.38	AVG	

### Conducted Emission Test Data

EUT	: TRAVEL CHARGER	Temperature:	20°C
M/N	: A1301Q	Humidity	: 50%
Test Voltage	: AC 230V/50Hz	Test Mode	: Full load
Test Engineer	: Bill	Phase	: N-Line

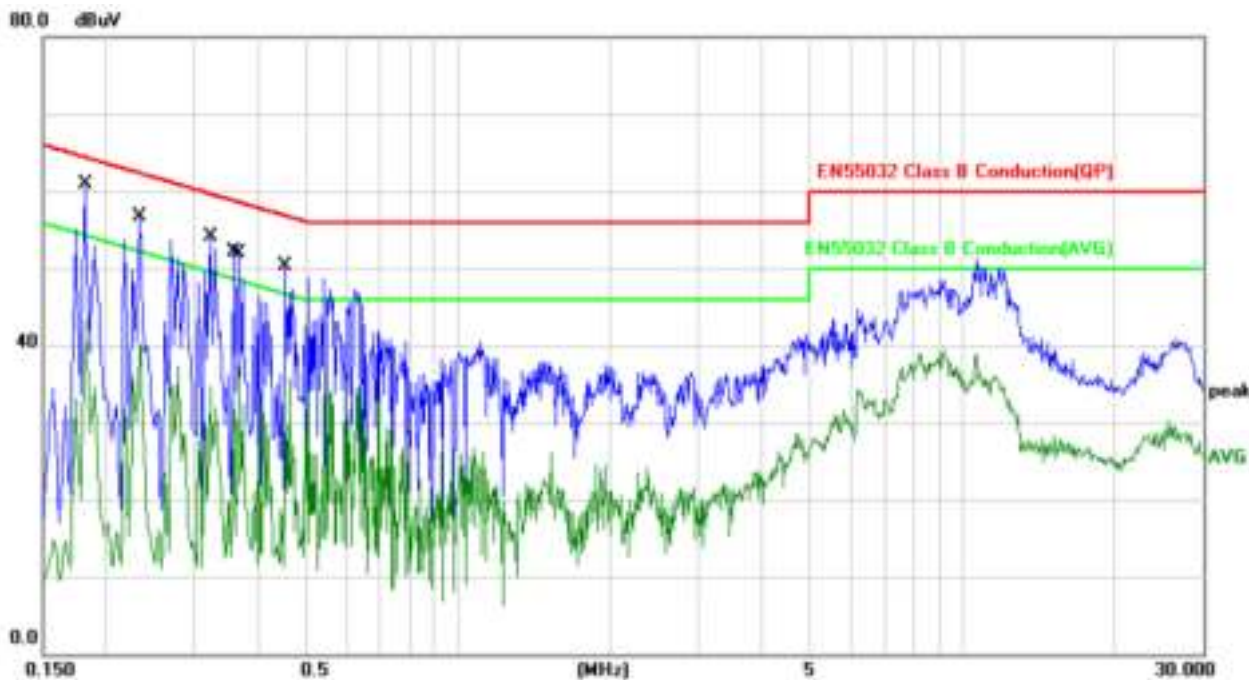

No.	Mk.	Freq. MHz	Reading Level dBµV	Correct Factor dB	Measurement dBµV	Limit dBµV	Over dB	Detector	Comment
1	^	0.1819	60.61	0.19	60.80	64.39	-3.59	QP	
2		0.1819	43.10	0.19	43.29	54.39	-11.10	AVG	
3		0.2340	56.47	0.20	56.67	62.30	-5.63	QP	
4		0.2340	40.05	0.20	40.25	52.30	-12.05	AVG	
5		0.3220	53.84	0.31	54.15	59.65	-5.50	QP	
6		0.3220	34.30	0.31	34.61	49.65	-15.04	AVG	
7		0.3580	51.70	0.32	52.02	58.77	-6.75	QP	
8		0.3580	31.46	0.32	31.78	48.77	-16.99	AVG	
9		0.3660	51.59	0.32	51.91	58.59	-6.68	QP	
10		0.3660	36.89	0.32	37.21	48.59	-11.38	AVG	
11		0.4540	49.95	0.32	50.27	56.80	-6.53	QP	
12		0.4540	35.35	0.32	35.67	46.80	-11.13	AVG	

## 4. RADIATED EMISSION MEASUREMENT

### 4.1. Block Diagram of Test

#### 4.1.1. Block diagram of test setup (In chamber)

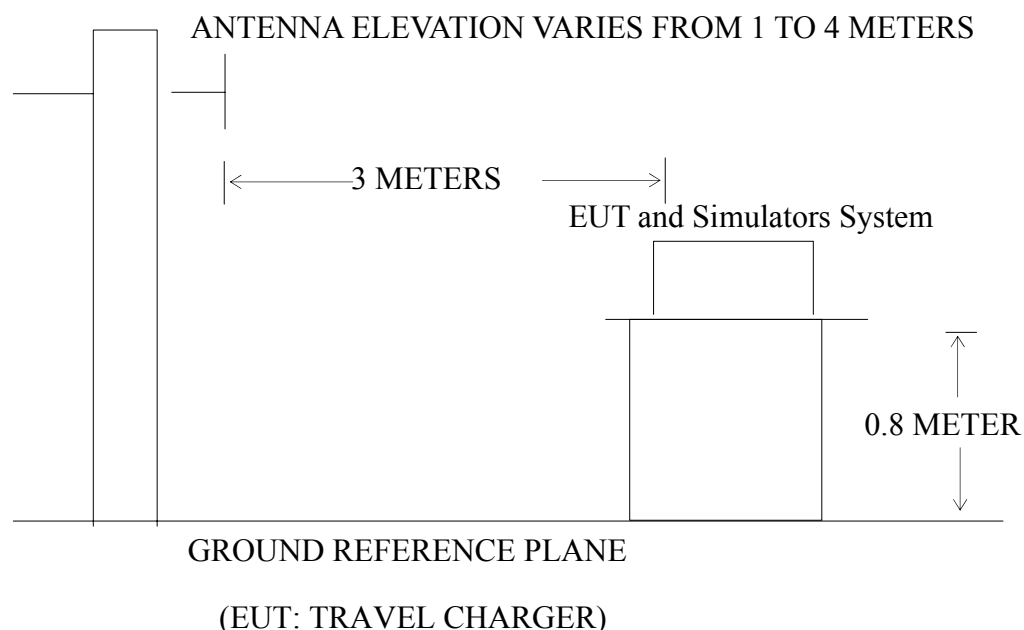

### 4.2. Measuring Standard

EN 55032:2015

Radiated Emission Limits

All emanations from a class B device or system, including any network of conductors and apparatus connected thereto, shall not exceed the level of field strengths specified below:

FREQUENCY (MHz)	DISTANCE (Meters)	FIELD STRENGTHS LIMIT (dB $\mu$ V/m)
30 ~ 230	3	40
230 ~ 1000	3	47

Note: (1) The smaller limit shall apply at the combination point between two frequency bands.

(2) Distance refers to the distance in meters between the measuring instrument antenna and the closed point of any part of the EUT.

### 4.3. EUT Configuration on Test

The EN 55032 regulations test method must be used to find the maximum emission during radiated emission measurement.

#### 4.4. Test Procedure

The EUT is placed on a turn table which is 0.8 meter high above the ground. The turn table can rotate 360 degrees to determine the position of the maximum emission level. The EUT is set 3 meters away from the receiving antenna which is mounted on a antenna tower. The antenna can be moved up and down from 1 to 4 meters to find out the maximum emission level. Bilog antenna (calibrated by Dipole Antenna) is used as a receiving antenna. Both horizontal and vertical polarization of the antenna are set on test.

The bandwidth of the Receiver (ESCS30) is set at 120kHz.  
The frequency range from 30MHz to 1000MHz is investigated.

Radiation Uncertainty:  $U_r = \pm 3.84$  dB

### Radiated Emission Test Data

EUT	:	TRAVEL CHARGER	Temperature:	20°C
M/N	:	A1301Q	Humidity	: 50%
Test Voltage	:	AC 230V/50Hz	Test Mode	: Full load
Test Engineer	:	Bill	Polarization	: Horizontal



No.	Mk.	Freq. MHz	Reading Level dBuV	Correct Factor dB(m)	Measure- ment dBuV/m	Limit dBuV/m	Over dB	Detector	Antenna Height cm	Table Degree degree	Comment
1		72.8466	52.66	-19.91	32.75	40.00	-7.25	QP			
2	!	101.6443	51.99	-16.79	35.20	40.00	-4.80	QP			
3	!	112.1305	49.07	-14.83	34.24	40.00	-5.76	QP			
4		175.6516	47.53	-15.83	31.70	40.00	-8.30	QP			
5	^	185.7882	52.50	-16.01	36.49	40.00	-3.51	QP			
6		195.8220	44.37	-14.92	29.45	40.00	-10.55	QP			

### Radiated Emission Test Data

EUT	: TRAVEL CHARGER	Temperature:	20°C
M/N	: A1301Q	Humidity :	50%
Test Voltage	: AC 230V/50Hz	Test Mode :	Full load
Test Engineer	: Bill	Polarization :	Vertical



No.	Mk.	Freq. MHz	Reading Level dBuV	Correct Factor dB(m)	Measure- ment dBuV(m)	Limit dBuV(m)	Over dB	Detector	Antenna Height cm	Table Degree degree	Comment
1	!	37.2855	48.99	-12.89	36.10	40.00	-3.90	QP			
2		72.0843	49.36	-20.39	28.97	40.00	-11.03	QP			
3	^	99.1797	53.52	-16.69	36.83	40.00	-3.17	QP			
4		110.1816	40.40	-14.83	25.57	40.00	-14.43	QP			
5		176.8878	47.58	-15.63	31.95	40.00	-8.05	QP			
6		187.7530	42.49	-15.94	26.55	40.00	-13.45	QP			

## 5. HARMONIC CURRENT EMISSION MEASUREMENT

### 5.1 Block Diagram of Test Setup

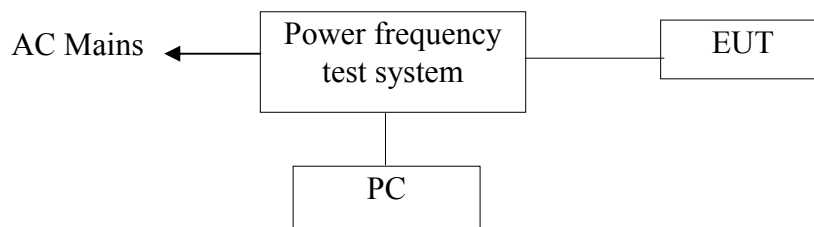

(EUT: TRAVEL CHARGER)

### 5.2 Measuring Standard

EN 61000-3-2: 2014

### 5.3 Description of test Equipment

Note: Equipment is less than 75W, no corresponding harmonic current limit.

## 6. VOLTAGE FLUCTUATION AND FLICKER MEASUREMENT

### 6.1 Block Diagram of Test Setup

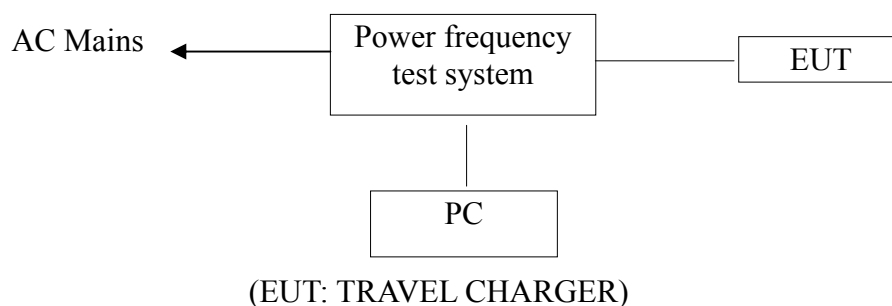

### 6.2 Measuring Standard

EN61000-3-3:2013



## Voltage Fluctuation Flicker Test Data

EN 61000-3-3 TEST REPORT 2017-11-08 11:25

Unit: TRAVEL CHARGER M/N: A1301Q  
 Test mode: Full load

Manufacturer: N/A  
 Operator: Bill

### TEST SETUP

Test Freq. : 50.00 Hz. Test Voltage: 231.0 vac  
 Waveform : SINE  
 Test Time: 120.0 min. Tshort: 10.0 min.  
 Prog. Zo Enabled: YES Prog. Zo: 0.000

Voltage Change less than once per Hour: NO  
 Impedance selected: IEC-725 STD. REF.

Synthetic R+L Enabled: NO  
 Resistance: 0.380 Ohms Inductance: 460.000 uH

### TEST DATA

Result:	PASS			
	EUT Data	Limit	Result	Test Enabled
Pst max	0.180	1.00	PASS	true
Plt max	0.171	0.65	PASS	true
dc %	0.00	3.00	PASS	true
dmax %	1.52	4.00	PASS	true
d(t) sec.	0.00	0.20	PASS	true

	Power Source Data			
Source Pst max	0.234	0.400	PASS	true
% THD	0.03	3.00	PASS	true

## 7. ELECTROSTATIC DISCHARGE IMMUNITY TEST

### 7.1 Block Diagram of Test Setup

#### 7.1.1 Block Diagram of the EUT and the simulators

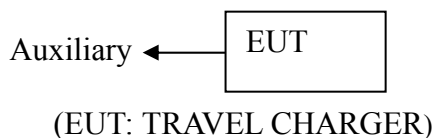

#### 7.1.2 Block diagram of ESD test setup

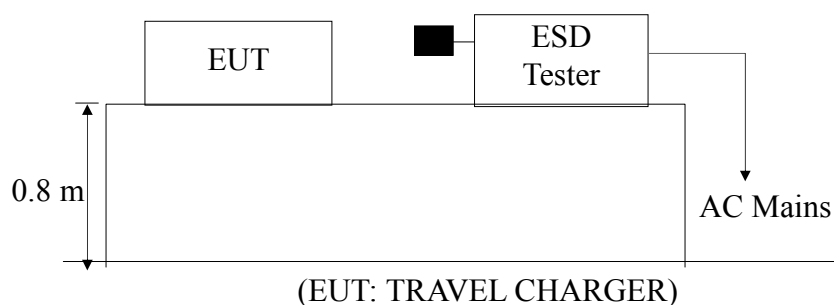

### 7.2 Test Standard

EN 55024:2010+A1:2015 (EN61000-4-2: 2009)

Severity Level: 3 / Air Discharge:  $\pm 8\text{KV}$  Level: 2 / Contact Discharge:  $\pm 4\text{KV}$

### 7.3 Severity Levels and Performance Criterion

#### 7.3.1 Severity level

Level	Test Voltage Contact Discharge (KV)	Test Voltage Air Discharge (KV)
1.	$\pm 2$	$\pm 2$
2.	$\pm 4$	$\pm 4$
3.	$\pm 6$	$\pm 8$
4.	$\pm 8$	$\pm 15$
X	Special	Special

#### 7.3.2 Performance criterion: **B**

## 7.4 Test Procedure

### 7.4.1 Air Discharge:

This test is done on a non-conductive surface. The round discharge tip of the discharge electrode shall be approached as fast as possible to touch the EUT. After each discharge, the discharge electrode shall be removed from the EUT. The generator is then re-triggered for a new single discharge and repeated 10 times for each pre-selected test point. This procedure shall be repeated until all the air discharge completed.

### 7.4.2 Contact Discharge:

All the procedure shall be same as Section 7.4.1. except that the tip of the discharge electrode shall touch the EUT before the discharge switch is operated.

### 7.4.3 Indirect discharge for horizontal coupling plane

At least 10 single discharges (in the most sensitive polarity) shall be applied at the front edge of each HCP opposite the center point of each unit (if applicable) of the EUT and 0.1m from the front of the EUT. The long axis of the discharge electrode shall be in the plane of the HCP and perpendicular to its front edge during the discharge.

### 7.4.4 Indirect discharge for vertical coupling plane

At least 10 single discharge (in the most sensitive polarity) shall be applied to the center of one vertical edge of the coupling plane. The coupling plane, of dimensions 0.5m X 0.5m, is placed parallel to, and positioned at a distance of 0.1m from the EUT. Discharges shall be applied to the coupling plane, with this plane in sufficient different positions that the four faces of the EUT are completely illuminated.

Electrostatic Discharge Test Result

EUT	: TRAVEL CHARGER	Temperature:	20℃
M/N	: A1301Q	Humidity	: 50%
Test Voltage	: AC 230V/50Hz	Test Mode	: Full load
Test Engineer	: Bill	Test Date	: 2017-11-08
Air Discharge: $\pm$ 8KV # For each point positive 10 times and negative 10 times discharge. Contact Discharge: $\pm$ 4KV # For each point positive 25 times and negative 25 times discharge.			
Location	Discharge Points	Kind A-Air Discharge C-Contact Discharge	Result
HCP	4 Points	C	PASS
VCP	4 Points	C	PASS
USB Port	1 Point	C	PASS
Slot	8 Points	A	PASS
Note: (The Criterion) A: Normal performance within the specification limits; B: Temporary degradation or less of function or performance which is self-recoverable; C: Temporary degradation or loss of function or performance which requires operator intervention or system reset;		Test Equipment :ESD Tester Model: ESD61002A	

## 8. RF FIELD STRENGTH SUSCEPTIBILITY TEST

### 8.1 Block Diagram of Test

#### 8.1.1 Block diagram of connection between the EUT and Load

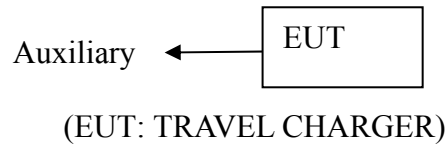

#### 8.1.2 Block diagram of RS test setup

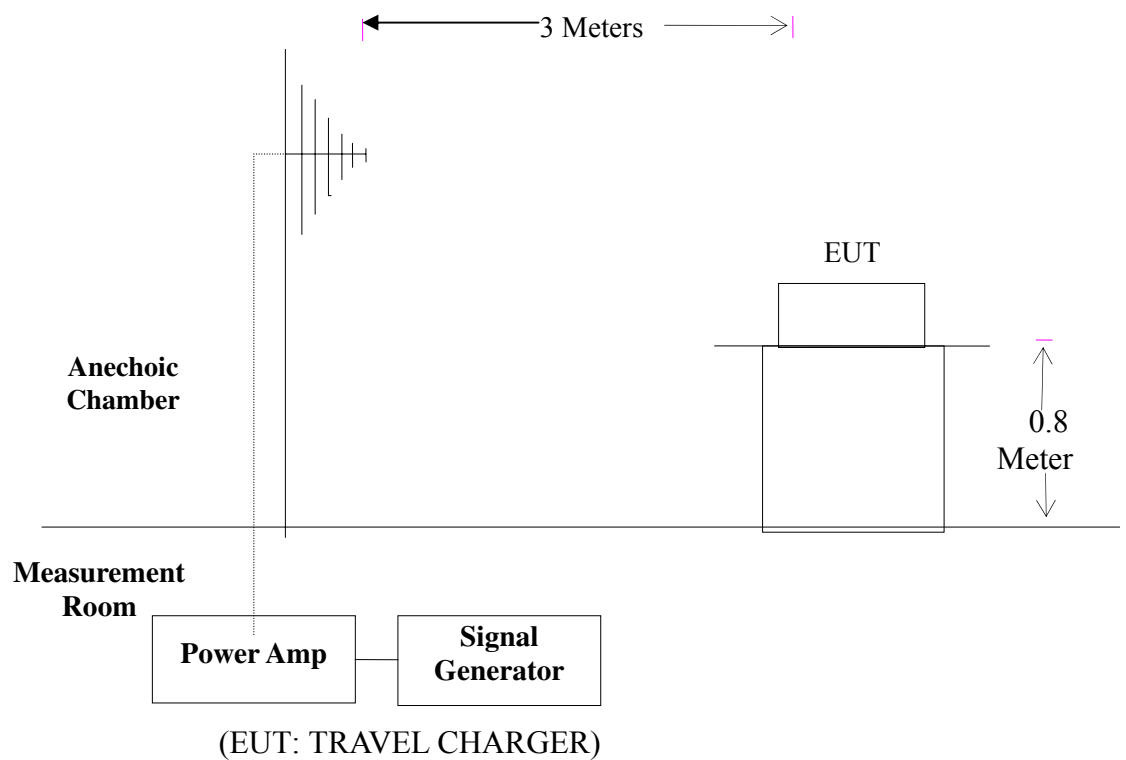

### 8.2 Test Standard

EN 55024:2010+A1:2015(EN61000-4-3: 2006 (Severity Level: 2, 3V / m))

### 8.3 Severity Levels and Performance Criterion

#### 8.3.1 Severity Levels

Level	Field Strength V/m
1.	1
2.	3
3.	10
X	Special

#### 8.3.2 Performance Criterion : A

### 8.4 Test Procedure

The EUT are placed on a table which is 0.8 meter high above the ground. The EUT is set 3 meters away from the transmitting antenna which is mounted on an antenna tower. Both horizontal and vertical polarization of the antenna are set on test. Each of the four sides of the EUT must be faced this transmitting antenna and measured individually. In order to judge the EUT performance, a CCD camera is used to monitor its screen. All the scanning conditions are as following:

Condition of Test	Remark
1. Fielded Strength	3V/m (Severity Level 2)
2. Radiated Signal	Modulated
3. Scanning Frequency	80-1000MHz
4. Sweep time of radiated	0.0015 Decade/s
2. Dwell Time	1 Sec.

RF Field Strength Susceptibility Test Results

EUT	: TRAVEL CHARGER	Temperature	: 22℃			
M/N	: A1301Q	Humidity	: 50 %			
Test Voltage	: AC 230V/50Hz	Test Mode	: Full load			
Field Strength	: 3 V/m	Test Date	: 2017-11-08			
Test Engineer:	Bill	Frequency Range:	80 MHz to1000 MHz			
Modulation:		<input type="checkbox"/> None	<input type="checkbox"/> Pulse <input checked="" type="checkbox"/> AM 1KHz 80%			
Frequency Rang 1:		Frequency Rang 2:				
80~ 1000MHz						
Steps	1	/	%	#	/	%
	Horizontal	Vertical		Horizontal	Vertical	
Front	PASS	PASS				
Right	PASS	PASS				
Rear	PASS	PASS				
Left	PASS	PASS				
<b>Test Equipment :</b> 1. Signal Generator : 2031 (MARCONI) 2. Power Amplifier : 500A100 & 100W/1000M1 (A&R) 3. Power Antenna : 3108 (EMCO) & AT1080 (A&R) 4. Field Monitor : FM2000 (A&R)						
<b>Note: Note: (The Criterion)</b> A:Normal performance within the specification limits; B:Temporary degradation or less of function or performance which is self-recoverable; C:Temporary degradation or loss of function or performance which requires operator intervention or system reset;						

## 9. ELECTRICAL FAST TRANSIENT/BURST IMMUNITY TEST

### 9.1 Block Diagram of Test Setup

#### 9.1.1. Block Diagram of the EUT

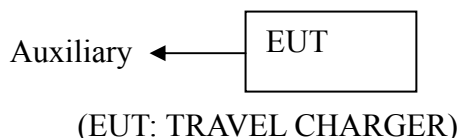

#### 9.1.2. EFT Test Setup

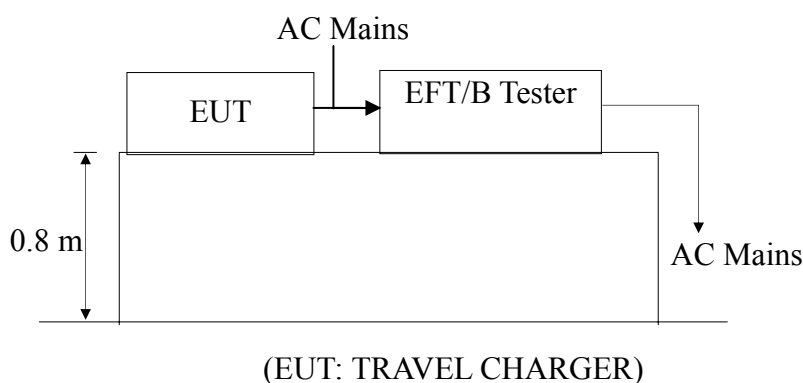

### 9.2 Test Standard

EN 55024:2010+A1:2015 (EN61000-4-4:2012, Severity Level, Level 2: 1KV)

### 9.3 Severity Levels and Performance Criterion

#### 9.3.1 Severity level

Open Circuit Output Test Voltage $\pm 10\%$		
Level	On Power Supply Lines	On I/O (Input/Output) Signal data and control lines
1.	0.5 KV	0.25 KV
2.	1 KV	0.5 KV
3.	2 KV	1 KV
4.	4 KV	2 KV
X	Special	Special

#### 9.3.2 Performance criterion : **B**

### 9.4 Test Procedure

The EUT is put on the table which is 0.8 meter high above the ground. This reference ground

H Building, Hongfa Science and Technology Park, Tangtou, Shiyan, Bao'an District, Shenzhen, China  
 Tel: +86-755-29113252 (30 lines) E-mail: service@poce-cert.com <http://www.poce-cert.com>



plane shall project beyond the EUT by at least 0.1m on all sides and the minimum distance between EUT and all other conductive structure, except the ground plane beneath the EUT, shall be more than 0.5m.

9.4.1 For input and output AC power ports:

The EUT is connected to the power mains by using a coupling device which couples the EFT interference signal to AC power lines. Both polarities of the test voltage should be applied during compliance test and the duration of the test is 2 mins.

9.4.2 For signal lines and control lines ports:

No I/O ports. It's unnecessary to test.

9.4.3 For DC output line ports:

It's unnecessary to test.



## 10. SURGE IMMUNITY TEST

### 10.1 Block Diagram of Test Setup

#### 10.1.1 Block Diagram of the EUT

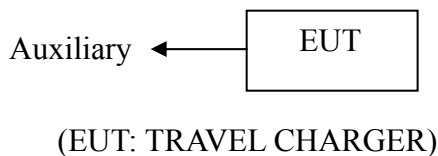

#### 10.1.2. Surge Test Setup

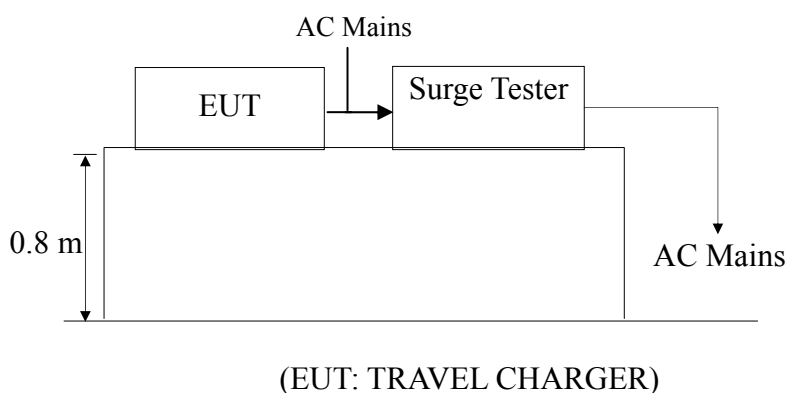

### 10.2 Test Standard

EN 55024:2010+A1:2015 (EN61000-4-5: 2014) Severity Level: Line to Line: Level 2, 1.0KV

### 10.3 Severity Levels and Performance Criterion

#### 10.3.1. Severity level

Severity Level	Open-Circuit Test Voltage KV
1	0.5
2	1.0
3	2.0
4	4.0
*	Special

#### 10.3.2 Performance criterion: **B**

### 10.3 Test Procedure

- 1) Set up the EUT and test generator as shown on Section 10.1.2.
- 2) For line to line coupling mode, provide a 1.0 KV 1.2/50us voltage surge (at open-circuit condition) and 8/20us current surge to EUT selected points.
- 3) At least 5 positive and 5 negative (polarity) tests with a maximum 1/min repetition rate are conducted during test.
- 4) Different phase angles are done individually.
- 5) Record the EUT operating situation during compliance test and decide the EUT immunity criterion for above each test.

Surge Immunity Test Result

EUT	: TRAVEL CHARGER	Temperature:	20℃		
M/N	: A1301Q	Humidity	: 50%		
Test Voltage	: AC 230V/50Hz	Test Mode	: Full load		
Test Engineer	: Bill	Test Date	: 2017-11-08		
Location	Voltage (KV)	1kV		2kV	
	Phase	+	-	+	-
L、N	0°	Pass	Pass		
	90°	Pass	Pass		
	180°	Pass	Pass		
	270°	Pass	Pass		
L、PE	0°				
	90°				
	180°				
	270°				
N、PE	0°				
	90°				
	180°				
	270°				

Test Equipment :Surge Tester Model: HCWG

Note: (The Criterion)

A:Normal performance within the specification limits;

B:Temporary degradation or less of function or performance which is self-recoverable;

C:Temporary degradation or loss of function or performance which requires operator intervention or system reset;

## 11. INJECTED CURRENTS SUSCEPTIBILITY TEST

### 11.1 Block Diagram of Test Setup

#### 11.1.1 Block Diagram of the EUT

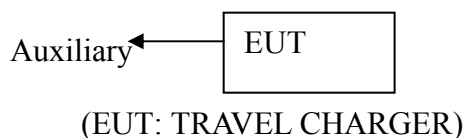

#### 11.1.2 Block Diagram of Test Setup

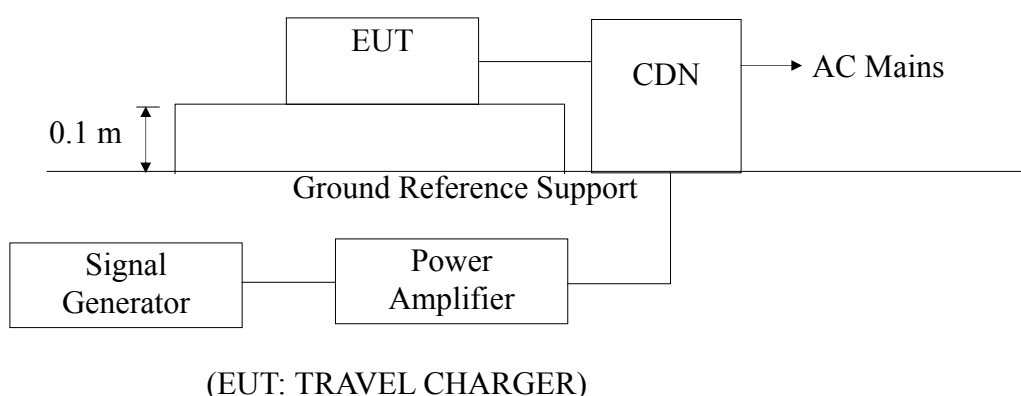

### 11.2 Test Standard

EN 55024:2010+A1:2015 (EN61000-4-6: 2014, Severity Level: Level 2, 3V (rms), (0.15MHz ~ 80MHz)

### 11.3 Severity Levels and Performance Criterion

#### 11.3.1 Severity level

Level	Field Strength V
1	1
2	3
3	10
X	Special

#### 11.3.2 Performance criterion: A

## 11.4 Test Procedure

- 1) Set up the EUT, CDN and test generators as shown on Section 11.1.2.
- 2) Let the EUT work in test mode and measure it.
- 3) The EUT are placed on an insulating support 0.1m high above a ground reference plane. CDN (coupling and decoupling device) is placed on the ground plane about 0.3m from EUT. Cables between CDN and EUT are as short as possible, and their height above the ground reference plane shall be between 30 and 50 mm (where possible).
- 4) The disturbance signal described below is injected to EUT through CDN.
- 5) The EUT operates within its operational mode(s) under intended climatic conditions after power on.
- 6) The frequency range is swept from 150KHz to 80MHz using 3V signal level, and with the disturbance signal 80% amplitude modulated with a 1KHz sine wave.
- 7) The rate of sweep shall not exceed  $1.5 \times 10^{-3}$  decades/s. Where the frequency is swept incrementally, the step size shall not exceed 1% of the start and thereafter 1% of the preceding frequency value.
- 8) Recording the EUT operating situation during compliance testing and decide the EUT immunity criterion.

Injected Currents Susceptibility Test Results

EUT	:	TRAVEL CHARGER	Temperature:	20°C
M/N	:	A1301Q	Humidity	: 50%
Test Voltage	:	AC 230V/50Hz	Test Mode	: Full load
Test Engineer	:	Bill	Test Date	: 2017-11-08
Frequency Range (MHz)		Injected Position	Strength (Unmodulated)	Result
0.15~80		AC Mains	3V	Pass
Frequency Range (MHz)		Injected Position	Strength (Unmodulated)	Result
Test Equipment :Injected Currents Tester Model: CWS500C Injection Clamp Model: F-2031-23MM CDN Model: CDN-M2, CDN-M3  Note: (The Criterion) A:Normal performance within the specification limits; B:Temporary degradation or less of function or performance which is self-recoverable; C:Temporary degradation or loss of function or performance which requires operator intervention or system reset;				



## 12. MAGNETIC FIELD SUSCEPTIBILITY TEST

### 12.1 Block Diagram of Test

#### 12.1.1 Block diagram of test setup

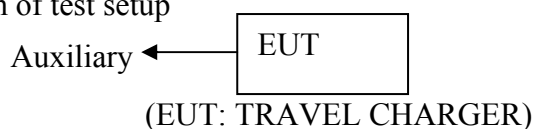

#### 12.1.2 Magnetic field test setup

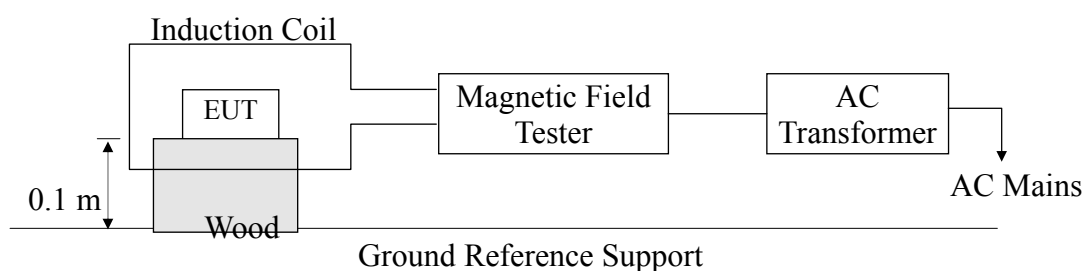

### 12.2 Test Standard

EN 55024:2010+A1:2015 (EN61000-4-8: 2010, Severity Level: Level 1, 1A / m)

### 12.3 Severity Levels and Performance Criterion

#### 12.3.1 Severity Levels

Level	Field Strength A/m
1	1
2	3
3	10
4	30
5	100
X	Special

#### 12.3.2 Performance Criterion : A

### 12.4 Test Procedure

The EUT is placed in the middle of a induction coil (1\*1m), under which is a 1\*1\*0.1m (high) table, this small table is also placed on a larger table,0.8 m above the ground. Both horizontal and vertical polarization of the induction coil are set on test, so that each side of the EUT is affected by the magnetic field. Also can reach the same aim by change the position of the EUT.

Magnetic Field Immunity Test Result

EUT	:	TRAVEL CHARGER	Temperature:	20°C
M/N	:	A1301Q	Humidity	: 50%
Test Voltage	:	AC 230V/50Hz	Test Mode	: Full load
Test Engineer	:	Bill	Test Date	: 2017-11-08
Test Level (A/M)		Testing Duration	Coil Orientation	Result
1		5 mins	X	Pass
1		5 mins	Y	Pass
1		5 mins	Z	Pass
Test Level (A/M)		Testing Duration	Coil Orientation	Result
Test Equipment :Magnetic Field Tester Model: HPFM T				
Note: (The Criterion)				
A:Normal performance within the specification limits;				
B:Temporary degradation or less of function or performance which is self-recoverable;				
C:Temporary degradation or loss of function or performance which requires operator intervention or system reset;				

## 13. VOLTAGE DIPS AND INTERRUPTIONS TEST

### 13.1 Block Diagram of Test Setup

#### 13.1.1 Block Diagram of the EUT

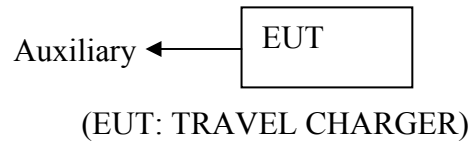

#### 13.1.2 Dips Test Setup

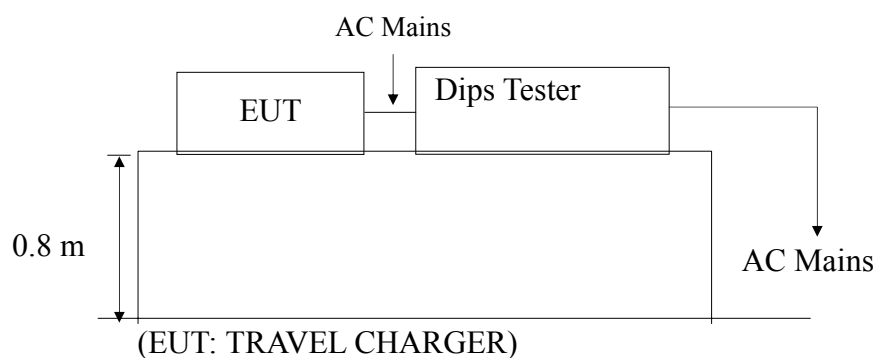

### 13.2 Test Standard

EN 55024:2010+A1:2015 (EN61000-4-11: 2004)

### 13.3 Severity Levels and Performance Criterion

#### 13.3.1 Severity level

Test Level %UT	Voltage dip and short interruptions %UT	Duration (in period)
0	100	0.5
40	60	1
70	30	5
		10
		25
		50
		*

#### 13.3.2 Performance criterion : **B&C&C**

### 13.4 Test Procedure

- 1) Set up the EUT and test generator as shown on Section 13.1.2.
- 2) The interruptions is introduced at selected phase angles with specified duration.
- 3) Record any degradation of performance.

Voltage Dips And Interruptions Test Results

EUT	:	TRAVEL CHARGER	Temperature:	20°C	
M/N	:	A1301Q	Humidity	: 50%	
Test Voltage	:	AC 230V/50Hz	Test Mode	: Full load	
Test Engineer	:	Bill	Test Date	: 2017-11-08	
Test Level % U <sub>T</sub>		Voltage Dips & Short Interruptions % U <sub>T</sub>	Duration (in periods)	Criterion	Result
0		100	0.5P	B	Pass
70		30	25P	C	Pass
0		100	250P	C	Pass
Test Level % U <sub>T</sub>		Voltage Dips & Short Interruptions % U <sub>T</sub>	Duration (in periods)	Criterion	Result

Test Equipment : Voltage Dips And Interruptions Tester Model: HPFS

Note: (The Criterion)  
A: Normal performance within the specification limits;  
B: Temporary degradation or less of function or performance which is self-recoverable;  
C: Temporary degradation or loss of function or performance which requires operator intervention or system reset;

## 14. PHOTOGRAPH

### 14.1 Photo of Conducted Emission



### 14.2 Photo of Radiated Emission

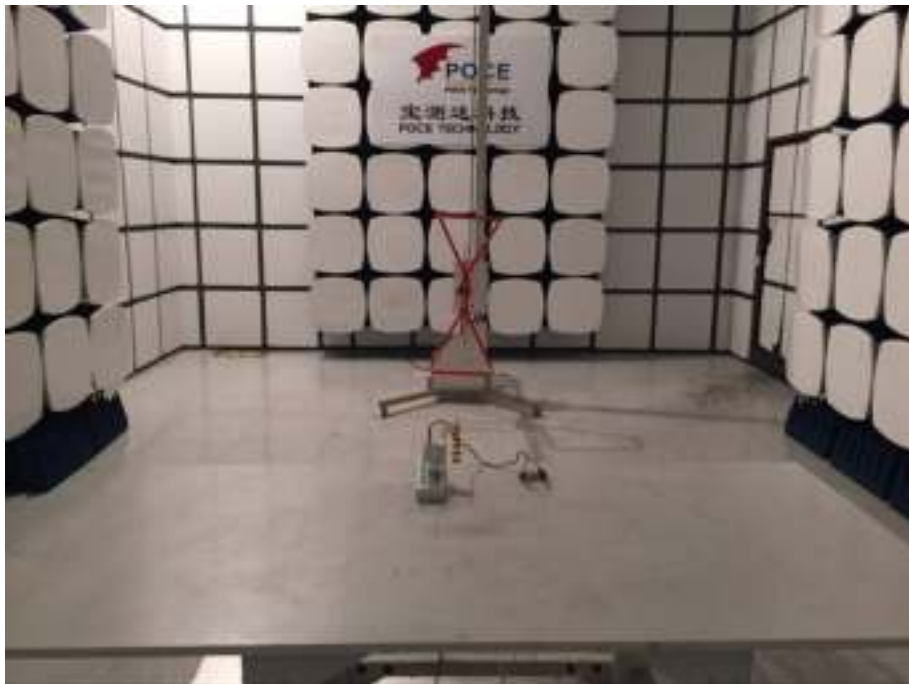

APPENDIX

Photo documentation

<p><b>Photo 1</b></p> <p>View:</p> <p><input type="checkbox"/> front</p> <p><input type="checkbox"/> rear</p> <p><input type="checkbox"/> right side</p> <p><input checked="" type="checkbox"/> left side</p> <p><input type="checkbox"/> top</p> <p><input type="checkbox"/> bottom</p> <p><input type="checkbox"/> internal</p>	
-----------------------------------------------------------------------------------------------------------------------------------------------------------------------------------------------------------------------------------------------------------------------------------------------------------------------------------	-------------------------------------------------------------------------------------

<p><b>Photo 2</b></p> <p>View:</p> <p><input type="checkbox"/> front</p> <p><input checked="" type="checkbox"/> rear</p> <p><input type="checkbox"/> right side</p> <p><input type="checkbox"/> left side</p> <p><input type="checkbox"/> top</p> <p><input type="checkbox"/> bottom</p> <p><input type="checkbox"/> internal</p>	
-----------------------------------------------------------------------------------------------------------------------------------------------------------------------------------------------------------------------------------------------------------------------------------------------------------------------------------	--------------------------------------------------------------------------------------

**Photo documentation**

<p><b>Photo 3</b></p> <p>View:</p> <p><input type="checkbox"/> front</p> <p><input type="checkbox"/> rear</p> <p><input type="checkbox"/> right side</p> <p><input type="checkbox"/> left side</p> <p><input type="checkbox"/> top</p> <p><input checked="" type="checkbox"/> bottom</p> <p><input type="checkbox"/> internal</p>	
-----------------------------------------------------------------------------------------------------------------------------------------------------------------------------------------------------------------------------------------------------------------------------------------------------------------------------------	-------------------------------------------------------------------------------------

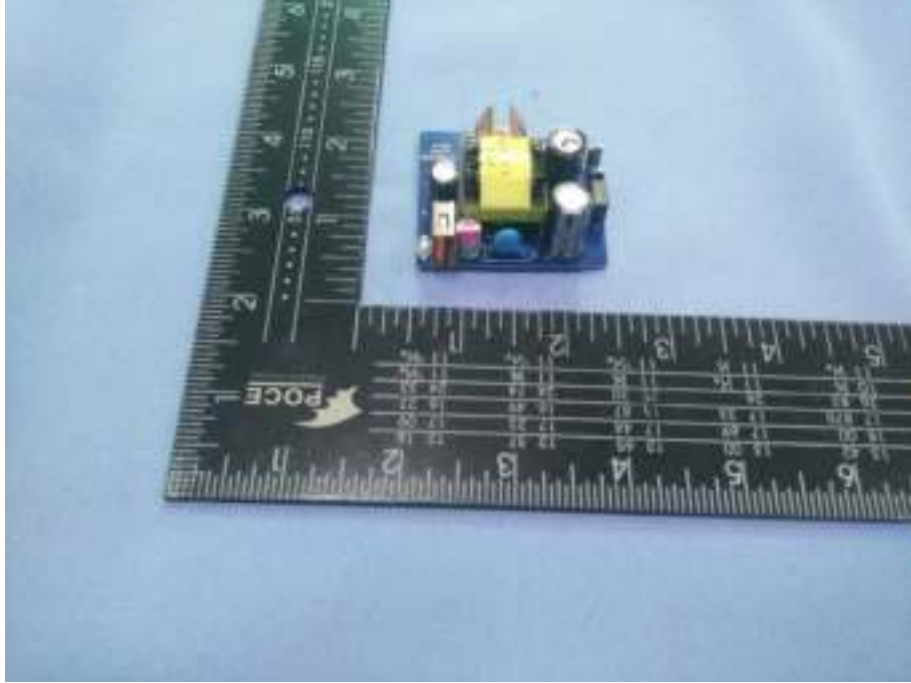
<p><b>Photo 4</b></p> <p>View:</p> <p><input type="checkbox"/> front</p> <p><input type="checkbox"/> rear</p> <p><input type="checkbox"/> right side</p> <p><input type="checkbox"/> left side</p> <p><input type="checkbox"/> top</p> <p><input type="checkbox"/> bottom</p> <p><input checked="" type="checkbox"/> internal</p>	
-----------------------------------------------------------------------------------------------------------------------------------------------------------------------------------------------------------------------------------------------------------------------------------------------------------------------------------	--------------------------------------------------------------------------------------

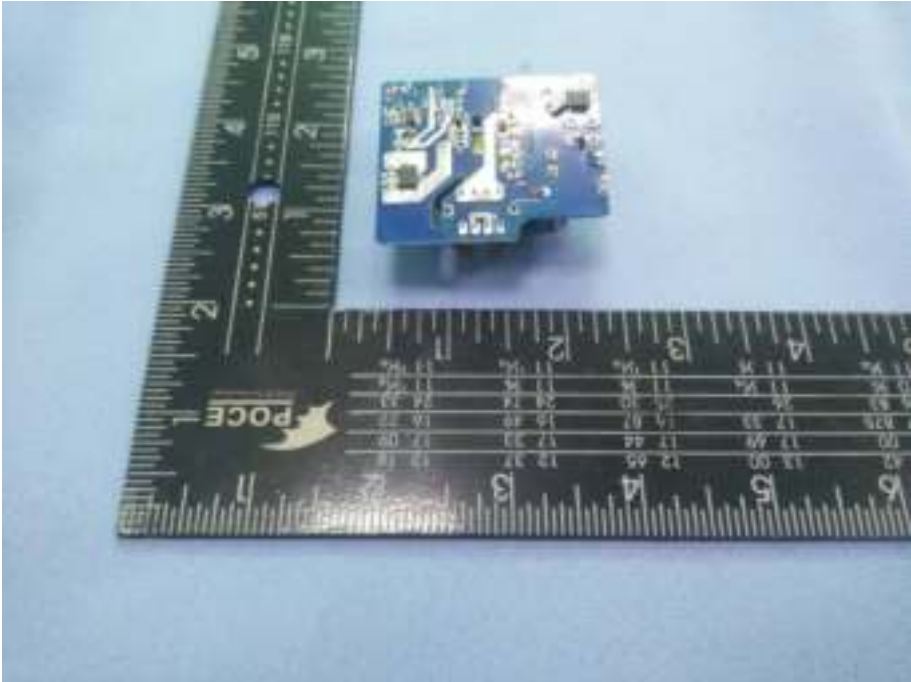

**Photo documentation**

<p><b>Photo 5</b></p> <p>View:</p> <p><input type="checkbox"/> front</p> <p><input type="checkbox"/> rear</p> <p><input type="checkbox"/> right side</p> <p><input type="checkbox"/> left side</p> <p><input type="checkbox"/> top</p> <p><input type="checkbox"/> bottom</p> <p><input checked="" type="checkbox"/> internal</p>	
-----------------------------------------------------------------------------------------------------------------------------------------------------------------------------------------------------------------------------------------------------------------------------------------------------------------------------------	-------------------------------------------------------------------------------------

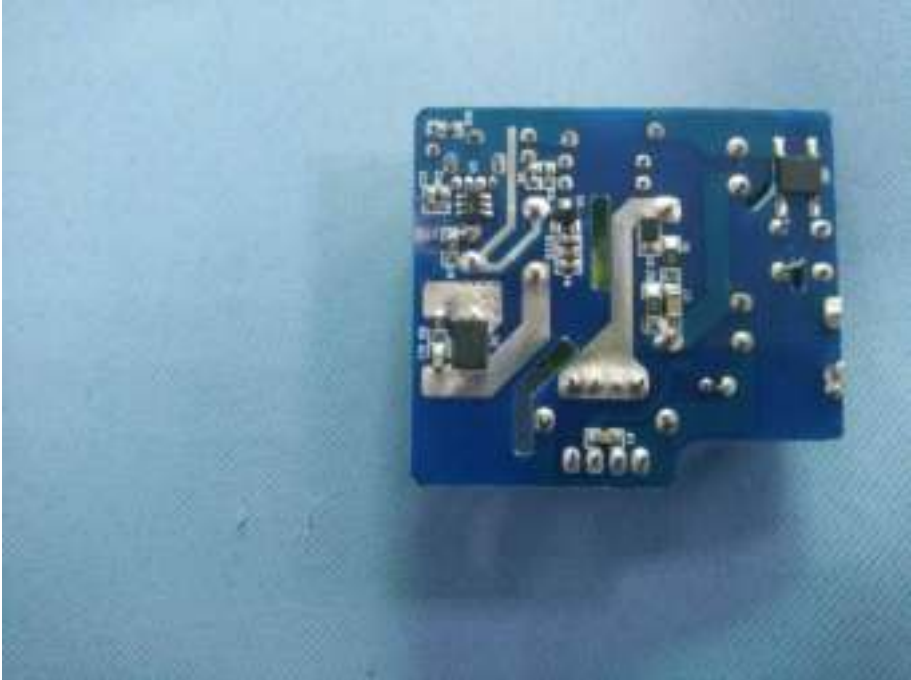
<p><b>Photo 6</b></p> <p>View:</p> <p><input type="checkbox"/> front</p> <p><input type="checkbox"/> rear</p> <p><input type="checkbox"/> right side</p> <p><input type="checkbox"/> left side</p> <p><input type="checkbox"/> top</p> <p><input type="checkbox"/> bottom</p> <p><input checked="" type="checkbox"/> internal</p>	
-----------------------------------------------------------------------------------------------------------------------------------------------------------------------------------------------------------------------------------------------------------------------------------------------------------------------------------	--------------------------------------------------------------------------------------

**Photo documentation**

<p><b>Photo 7</b></p> <p>View:</p> <p>[ ] front</p> <p>[ ] rear</p> <p>[ ] right side</p> <p>[ ] left side</p> <p>[ ] top</p> <p>[ ] bottom</p> <p>[<input checked="" type="checkbox"/>] internal</p>	
-------------------------------------------------------------------------------------------------------------------------------------------------------------------------------------------------------	-------------------------------------------------------------------------------------

\*\*\*\*\*THE END OF REPORT\*\*\*\*\*