

tineco

PURE ONE S12 SERIES Smart Vacuum Cleaner

Bedienungsanleitung

Instruction Manual

Manual De Uso

Mode D'emploi

Manuale D'istruzioni

Instrukcja obsługi



*Actual product may differ from illustration.

TINECO IS HERE TO HELP.

We'll get back to you within 1 business day.



 www.tineco.com

CONTENTS

EN

- Important Safety Instructions.....29
- Specifications31
- Overview.....32
- Accessories.....34
- Assembly36
- Operation.....38
- Maintenance46
- Troubleshooting.....50
- Warranty52

TINECO IS HERE TO HELP.

We'll get back to you within 1 business day.

 www.tineco.com

Important Safety Instructions

SAVE THESE INSTRUCTIONS

Household use only.

When using an electrical appliance, basic precautions should always be followed, including the following:

READ ALL INSTRUCTIONS BEFORE USING (THIS APPLIANCE). Failure to follow the warnings and instructions may result in electric shock, fire and/or serious injury.

WARNING – To reduce the risk of fire, electric shock, or injury:

1. This appliance can be used by children aged from 8 years and above and persons with reduced physical, sensory or mental capabilities or lack of experience and knowledge if they have been given supervision or instruction concerning use of the appliance in a safe way and understand the hazards involved. Children shall not play with the appliance. Cleaning and user maintenance shall not be made by children without supervision.
2. The appliance is not to be used by persons (including children) with reduced physical, sensory or mental capabilities, or lack of experience and knowledge, unless they have been given supervision or instruction.
3. For INDOOR use ONLY. Do not use the appliance in outdoors, nor in commercial or industrial environments. Do not use the appliance on wet surfaces or surfaces with standing water.
4. Do not allow to be used as a toy. Close attention is necessary when used by or near children, pets or plants.
5. Use only as described in this manual. Use only manufacturer's recommended attachments.
6. Do not use with a damaged cord or plug. If appliance has been dropped, damaged, left outdoors, dropped into water, or is not working as it should, return it to a service center.
7. Do not handle charger, including charger plug, and charger terminals with wet hands.
8. Do not put any object into openings. Do not use with any openings blocked; keep free of dust, lint, hair, and anything that may reduce air flow.
9. Keep hair, loose clothing, fingers, and all parts of your body away from openings and moving parts.
10. Use extra care when cleaning on stairs.
11. Do not use to pick up flammable or combustible liquids, such as gasoline, or use in areas where they may be present.
12. Do not pick up anything that is burning or smoking, such as cigarettes, matches, or hot ashes.
13. Do not use without a filter.
14. Prevent unintentional activation. Ensure the switch is in the off position before connecting to the battery pack, picking up or carrying the appliance. Carrying the appliance with your finger on the switch or powering on the appliance with the switch on may cause accidents.



15. Disconnect the battery pack from the appliance before making any adjustments, changing accessories, storing the appliance. Such preventive safety measures reduce the risk of starting the appliance accidentally.
16. For the purposes of recharging the battery, only use the detachable supply unit provided with this appliance. A charger that is suitable for one type of battery pack may create a risk of fire when used with another battery pack.
17. Use appliances only with specifically designated Tineco battery packs. Use of any other battery packs may create a risk of injury and fire.
18. When battery pack is not in use, keep it away from other metal objects, like paper clips, coins, keys, nails, screws or other small metal objects, that can make a connection from one terminal to another. Shorting the battery terminals together may cause burns or a fire.
19. Under abusive conditions, liquid may be ejected from the battery; avoid contact. If contact accidentally occurs, flush with water. If liquid comes into eye contact, seek medical help. Liquid ejected from the battery may cause irritation or burns.
20. Do not use a battery pack or appliance that is damaged or modified. Damaged or modified batteries may exhibit unpredictable behavior resulting in fire, explosion or risk of injury.
21. Do not expose a battery pack or appliance to fire or excessive temperature. Exposure to fire or temperature above 266°F (130°C) may cause an explosion.
22. Follow all charging instructions and do not charge the battery pack or appliance outside of the temperature range specified in the instructions. Charging improperly or at temperatures outside of the specified range may damage the battery and increase the risk of fire.
23. Have servicing performed by a qualified repair person using only identical replacement parts. This will ensure that the safety of the product is maintained.
24. This appliance contains battery cells that are non-replaceable. Do not modify or attempt to repair the appliance or the battery pack except as indicated in the instructions for use and care.
25. Always turn off this appliance before connecting or disconnecting the motorized nozzle.
26. Do not charge or store the appliance outdoors or inside a car. Only charge, store or use the battery in a dry indoor area where the temperature is higher than 39.2°F (4°C) but lower than 104°F (40°C). The charger is for indoor use only.

Recycling Instructions according to Battery Law



The rechargeable battery contains materials that are harmful to the environment and must therefore be removed from the device before disposal. The device must be switched off to remove the rechargeable battery.

Batteries and rechargeable batteries must not be disposed of in household waste! Every consumer is obliged to hand in all batteries and rechargeable batteries, regardless of whether they contain harmful substances or not, at a collection point in his or her municipality/district or at a retailer, so that they can be disposed of in an environmentally friendly manner. Batteries and rechargeable batteries should only be returned when discharged.

Batteries and rechargeable batteries are therefore marked with the symbol left.

Recycling Instructions according to WEEE



Waste electrical and electronic equipment must not be disposed of with household waste! Every consumer is obliged to hand in all appliances at the end of their service life at a collection point in his or her municipality/district or at a retailer so that they can be disposed of properly and in an environmentally friendly manner.

The illustration left shows the wheeled bin symbol indicating separate collection of waste electrical and electronic equipment (WEEE).

For EU Countries:

For EU Declaration of Conformity information, please visit www.tineco.com.

Symbols:

	Read the instruction manual
	Class II
	Short-circuit-proof safety isolating transformer
	Switch mode power supply
	For indoor use only
	Direct current
	Alternating current

EN

Specifications

Product	PURE ONE S12 SERIES
Voltage	21.6V
Rated Power	500W
Dustbin Capacity	0.6L
Charging Time	3-4 hrs for one battery
AC Input	100-240V~
WiFi Frequency Bands	2.4G
WiFi Maximum Output Power	19dB

Overview

EN

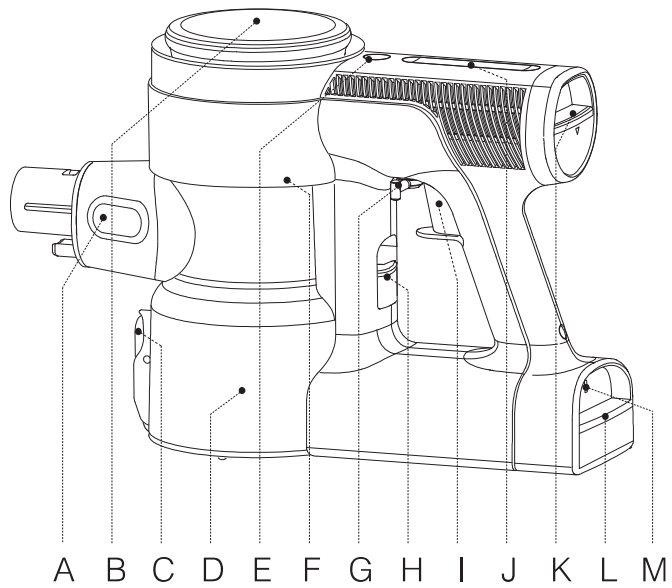

- | | |
|--------------------------------|----------------------------|
| A. Dust sensor | G. Trigger lock |
| B. Digital display | H. Dustbin release button |
| C. Dust empty release button | I. Trigger |
| D. Dustbin | J. Power control slider |
| E. AUTO mode | K. HEPA release button |
| F. WiFi reset button | L. Battery release button |
| (Remove the dustbin to access) | M. Battery indicator light |

Digital Display

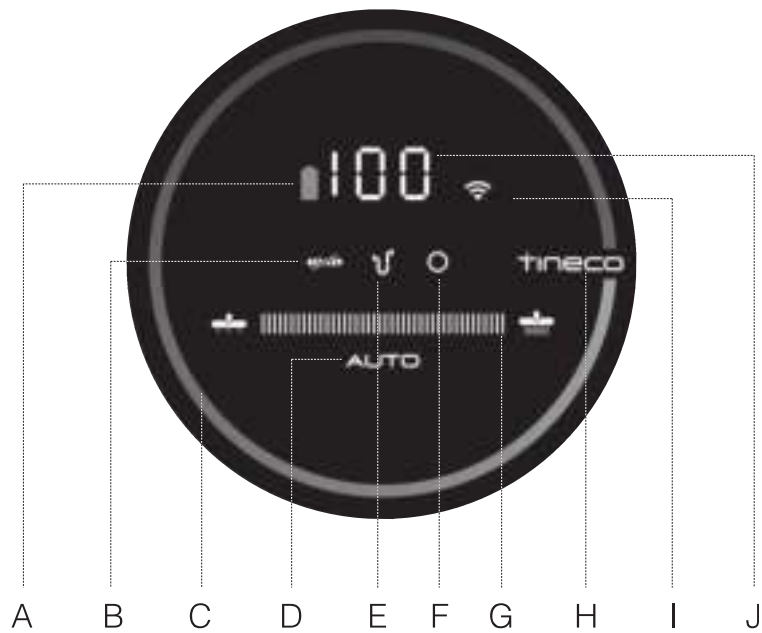

EN

- | | |
|---|----------------------------|
| A. Battery icon | E. Air channel blocked |
| B. Brush roller tangled | F. Dust sensor malfunction |
| C. Dust monitoring loop
(Blue to red according to the dust amount) | G. Power indicator |
| D. AUTO mode | H. Tineco logo |
| | I. WiFi indicator |
| | J. Battery level indicator |

Accessories

Note:

- Test an accessory on a small, inconspicuous area before use on sensitive surfaces.
- To identify what should be included with your purchase, please refer to the "Included Accessories" located on the packaging box.
- As shown below, there are many components compatible with this model. If you require more accessories, please go to www.tineco.com or store.tineco.com.

EN

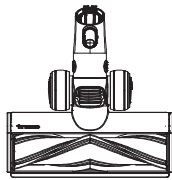

Direct-drive LED multi-tasker power brush

Direct-drive technology increases cleaning efficiency and ensures a highly dynamic clean; very effective for cleaning fine dust and debris on the carpet and hard floor. LED headlights help you clean the hard-to-see spots.

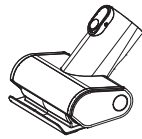

Mini power brush

For vacuuming upholstered furniture, mattresses etc. Vacuums pet hair and removes ingrained dirt.

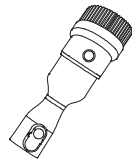

2-in-1 dusting brush

Switches between a wide and a soft brush by pressing the release button. The soft brush is most effective on hard-surface furniture while the wide brush is effective for upholstered furniture, curtains, etc.

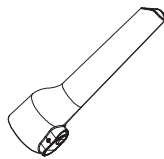

Crevice tool

For corners, nooks, and other hard-to-reach places such as around car seats, picture frames, and cupboards.



Soft dusting brush

Angled bristles on a slender, oval-shaped rim provide anti-static, cushioned contact. Suitable for dusting shelves, lighting, delicate surfaces, electronics and more.



Flexible long crevice tool

Easy to bend, easy to reach tight spots. Suitable for cleaning dust behind and beneath furniture, around refrigerators, and many other tight gaps.

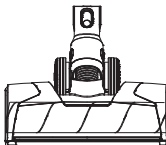

Full-size LED soft-roller power brush

Perfect for hard floors, especially sensitive wood floor. Picks up coarse and fine dirt at the same time.

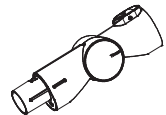

Multi-angle folding tube

An articulated joint makes it adjustable to allow for flexibility when cleaning from high to low.



Flexible extension hose

Excellent extension and flexibility to access hard-to-reach spaces; perfect for in-care use. Compatible with all non-motorized Tineco accessories.

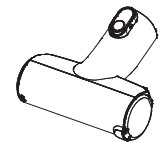

Automatic pre-filter cleaning tool

A dirty filter is a leading cause of suction loss, and this tool is designed to make your filter last much longer. Simply place the dirty filter inside the automatic pre-filter cleaning tool and close the lid. Connect the tool to the main body and pull the trigger. The appliance will automatically shut off once the task is complete.

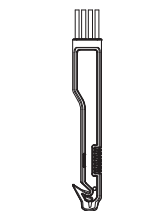

Hair cleaning tool

Use the end with the small blade to remove hair and debris wrapped around the roller. Use the end with the brush to clean the brush window, and the dustbin, as required.

Assembly

Tube Installation

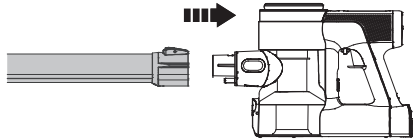

Insert tube.

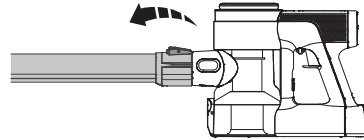

Press the release button and remove tube.

EN

Brush Installation

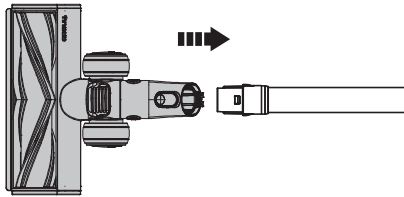

Insert the power brush.

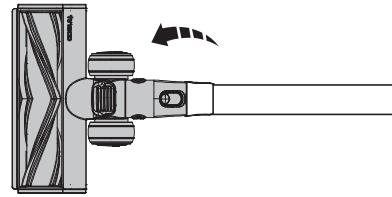

Press the release button and remove power brush.

Dustbin Installation

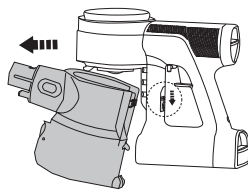

To clean the dustbin more thoroughly, press the dustbin release button to fully detach from the appliance.

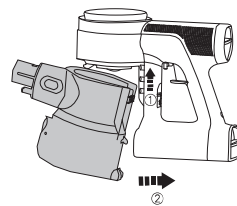

When re-attaching the dustbin, hold on an angle and slot the top of the dustbin into the hook on the main body. Push upwards until the hook is fixed into the slot on the dustbin and then it clicks into place.

Battery Installation

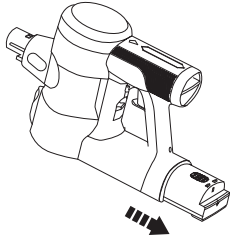

Press the battery release button, and remove the battery.

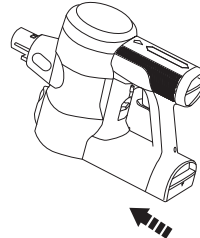

To replace, slide the battery into the slot at the base of the main body. The battery will click into position when correctly fitted.

Wall-mounted Dock Installation

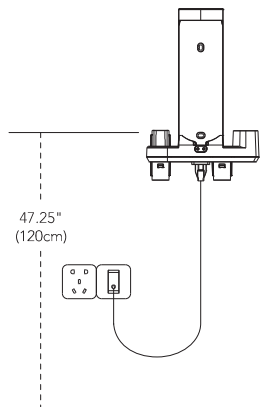

Determine the best wall location for mounting the dock. We recommend placing it 47.25" (120cm) from the lower screw hole to the floor (may need to be adjusted based on the actual situation).

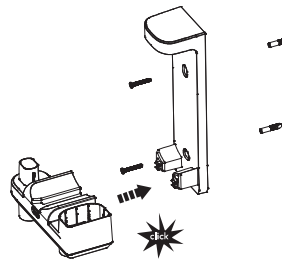

Assemble the two bracket components, with a "click" to signify correct assembly. Once this is complete, use the screws provided by Tineco to affix the dock to the wall.

Warning:

- Ensure the wall surrounding the mounting area is free of gas, water pipes, electrical cables and wires.
- To avoid the dock falling, ensure it is firmly installed.

Operation

Preparing for Use

Note:

- Before the first use, please charge the appliance (see "Charging the Battery") for 3-4 hours in an area where the ambient temperature is between 39.2°F (4°C) and 104°F (40°C).
- Select an accessory and attach it to the appliance before use (see "Accessories").

EN

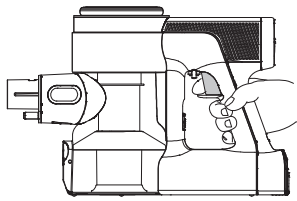

Pull the trigger to activate the suction.

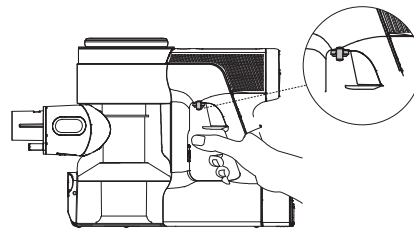

Pull the trigger lock to hold the trigger for continuous power mode.

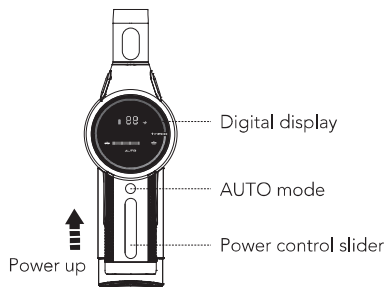

The appliance will start in AUTO mode by default. Swipe the power control slider to switch to Manual mode. Long-press the AUTO button to switch back to AUTO mode.

Cleaning Mode Selection

AUTO Mode

- In AUTO mode, the power indicator and the color of dust monitoring loop change according to the amount of dust detected. A red dust monitoring loop indicates more dust is detected whereas a blue loop indicates less is detected. This mode automatically provides the best cleaning solution.

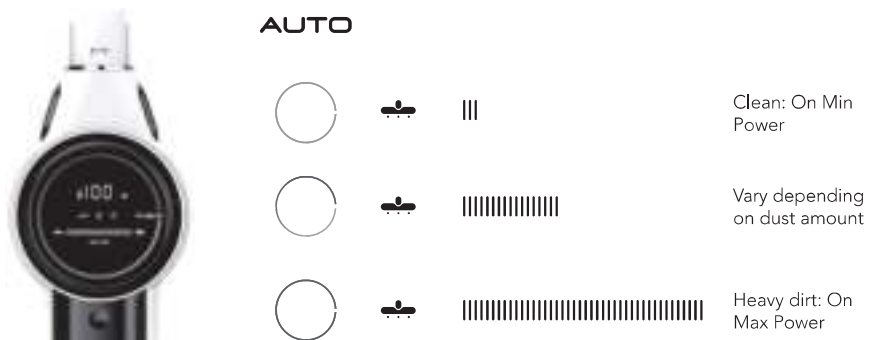

EN

- Keep sharp objects away from the digital display to avoid scratches and scrapes.

To enter AUTO mode:

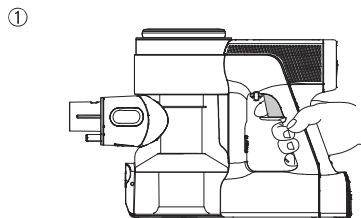

The default setting on startup is AUTO. The appliance then takes 3 seconds to initially detect blockages or dust. If no dust is detected, power is reduced to conserve energy.

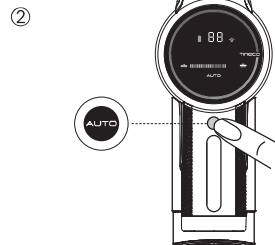

When in Manual mode, press AUTO for 2 seconds until the AUTO indicator illuminates.

Manual Mode



From AUTO mode, swipe the power control slider to switch to Manual mode. In Manual mode, you can control the power as needed.

Note:
Only use with dry hands. Dirty hands may affect slider operation.

APP

- All the functions can be performed using the Tineco app. Download the Tineco app from the App Store, Google Play and Tineco Official Site.

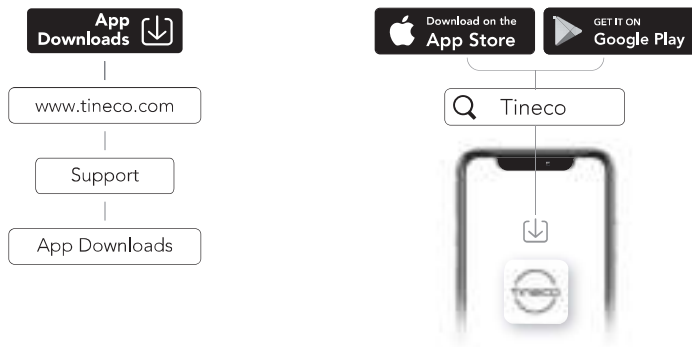

App Function Introduction



Battery
Battery level in real time.



Cleaning report
Displays the dust amount, working hours and working status.



Suction adjustment
When in manual mode, swipe the phone screen to adjust suction power.



Reminder of filter status
Records the severity of the dirty filter and provides a cleaning reminder as required.



Contact us
You can contact the Customer Service about any problems during the working hours.



Feedback
If you have any comments, please send us your feedback.

Emptying the Dustbin

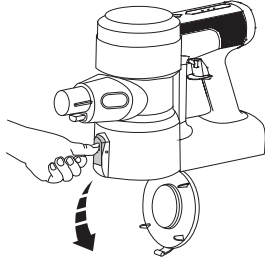

Press the release button on the side of the dustbin and empty the contents.

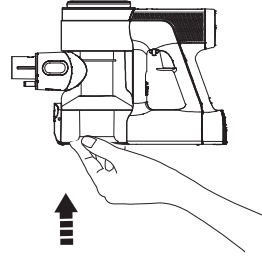

Close and click the dustbin flap back into place.

EN

- Place the appliance on the wall-mounted dock for convenient storage and recharging after use.

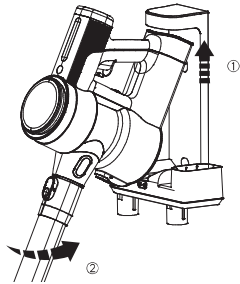

Place the main body on the dock.

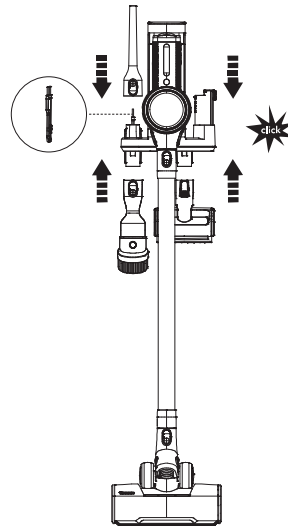

To avoid bristle damage, always place attachments on the dock after use.

Charging the Battery

- When secured on the wall-mounted dock, the battery attached to the main body will charge first, followed by the spare battery.

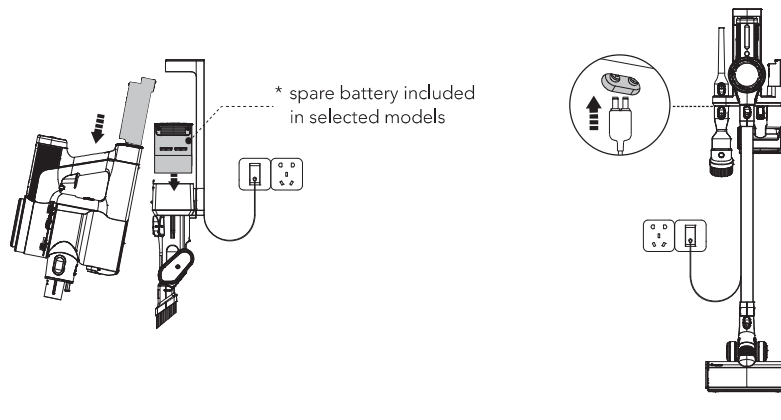

Connect the adaptor to the dock and outlet.

To charge, secure the main body and/or the spare battery on the dock. The battery can be recharged while attached to the main body, or separately.

Note:

- If you need a spare battery, please purchase from Tineco.

Warning:

- Only use the Tineco-provided adaptor to charge the battery.
- During long periods of not being used, store the lithium battery in a cool, dry place. Ensure the battery is half-charged every 3 months (Battery level > 50%).
- Store appropriately indoors in a dry place. Do not expose appliance to sunlight or freezing temperature. Recommended temperature range: 39.2°F (4°C)~104°F (40°C).

Runtime

- When in AUTO mode, the runtime is approximately 50 minutes. When MAX power is used, the runtime is approximately 10.5 minutes. (for one battery)
- Estimated runtime data was obtained by a Tineco Laboratory using one battery and non-motorized accessories.

Charging Time

- A full charge takes approximately 3-4 hours for one battery.
- Estimated data was obtained by a Tineco Laboratory using ambient temperatures between 39.2°F (4°C) to 104°F (40°C).

Indicator

- For any of the following notifications, consult the "Troubleshooting" section of this manual.



When in Use



Battery level > 20%: solid green light.



Battery level ≤ 20%: solid red light.



Blinking red light: fault.



Blinking: brush roller has a blockage.



Blinking: appliance has a blockage, either in the filter or the dustbin.



Blinking: sensor inside the dustbin is obstructed, or the dustbin is not correctly installed.

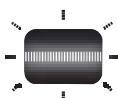

Blinking: motor failure.



Illuminated: WiFi has successfully connected.



Blinking: WiFi is connecting.



Off: WiFi is not connected, please connect.

During Charging

- The spare battery will only charge when the one attached to the main body has been fully charged (spare battery included in selected models).

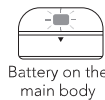

Battery on the main body

Charging (Battery level 0%~99%)

Battery icon: solid green.

Battery indicator: blinking green.

Tineco indicator: blinking.



Battery on the main body

Fully charged (Battery level up to 100%)

In 5 mins

Battery icon & Battery indicator: solid green.

Tineco indicator: illuminated.

After 5 minutes: all indicator lights turn off.



Battery icon blinking green:

No battery pack or battery pack installed incorrectly.

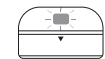

Both blinking red: fault.

Maintenance

Note:

- Clean the dustbin and filters after each use.
- Use the cleaning tool to thoroughly clean the pre-filter when the indicator light shows a blocked air channel. To maintain high performance, wash and dry the pre-filter monthly, replacing it every 6 months.

Wash and dry the HEPA filter every 3 months, replacing it every 12 months.

Dustbin and Mesh Filter

1

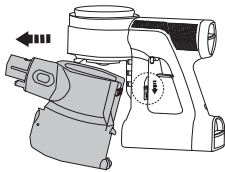

Press the dustbin release button to remove the dustbin.

2

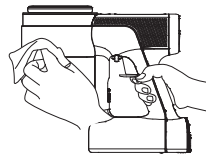

Clean with a damp cloth, taking care to prevent water entering the appliance main body and battery.

3

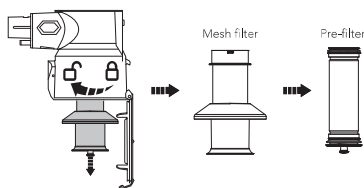

Turn counter-clockwise to remove the filters.

4

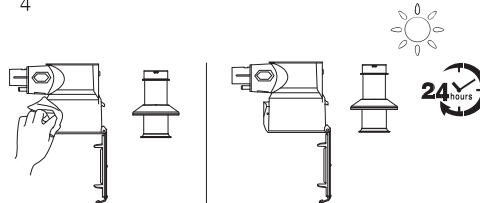

Clean the dustbin and mesh filter with a damp cloth. Air dry completely before reinstalling.

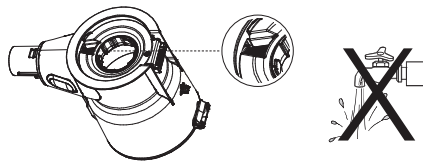

⚠ Warning:

- Do not wash the dustbin as it contains a dust sensor. If it comes into contact with water, please dry it with a hair dryer.

Pre-filter

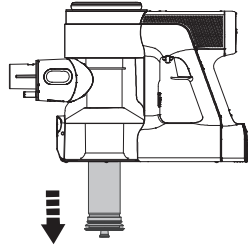

Ensure the appliance is switched off before cleaning, and remove the dirty pre-filter from the mesh filter-holder.

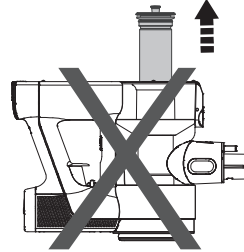

Do not turn the appliance upside down when removing or installing the filter to prevent dust from entering the motor.

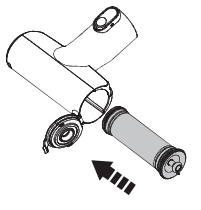

Replace a clean filter to the main body. Put the dirty pre-filter into the cleaning tool and connect the cleaning tool to the main body.

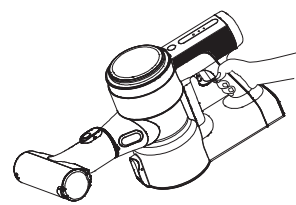
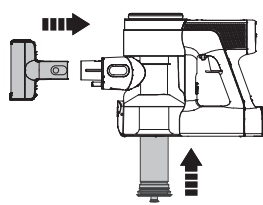

Activate the suction to clean the pre-filter. The appliance will automatically switch off after once cleaning is completed. Retain the clean pre-filter as a spare which can be reused.

EN

HEPA Filter

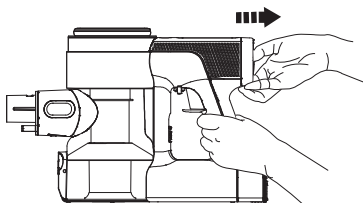

Press the HEPA release button and gently remove for cleaning. Do not use the appliance without first installing the HEPA filter.

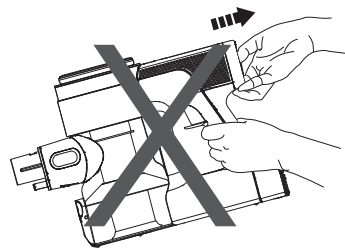

Do not place the appliance as above when removing or installing the HEPA filter, to prevent dust from entering the motor.

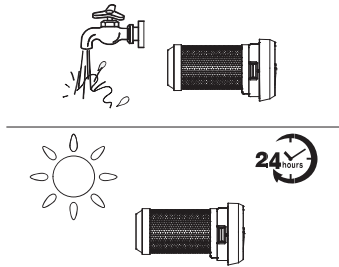

The HEPA filter can be washed under running water and must be completely dry before reinstalling.

EN Dust Sensor

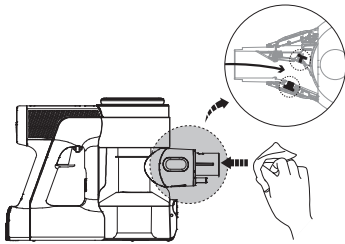

To avoid dust accumulation which can affect cleaning performance, wipe the suction mouth with a damp cloth.

Mini Power Brush

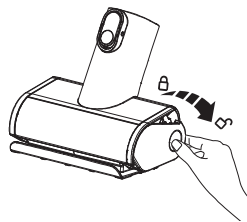

Press against the roller end cover downward.

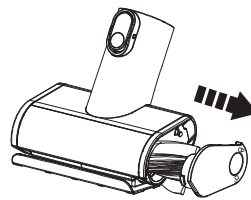

Pull out the brush roller.

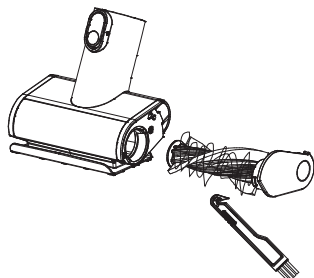

Remove the debris wrapped around the roller with the Tineco Hair Cleaning Tool.

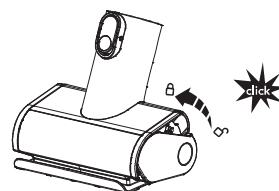

Fully reinsert the brush roller at an angle and push upward until it clicks securely back into place.

Brush Roller

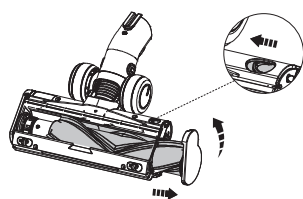

Slide the switch to open the brush roller end cover, and rotate it counter-clockwise to be able to pull out the brush roller.

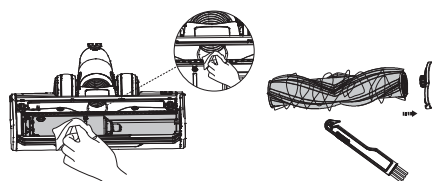

After removing the brush roller, gently clean the brush window and suction mouth. Remove the debris wrapped around the roller with the Tineco Hair Cleaning Tool.

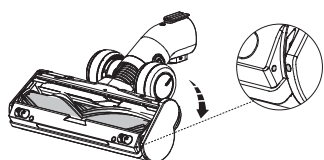









Fully reinsert the brush roller into the brush window and the end cover can be rotated clockwise until it clicks securely back into place.

Warning:

- The power brush contains electrical components which must not be soaked or washed with water.

Troubleshooting

Problem	Possible cause	Solution
The appliance does not turn on	No power	Charge the battery
	Auto protection for overheating	Restart after cooling down
	The suction mouth is blocked	Check and remove blockages
Weak suction power	Dustbin and filters are full	Clean the dustbin and filters
	The pre-filter is not installed	Install the pre-filter
	The appliance is blocked (i.e. the tube, suction mouth or some other parts)	Remove blockages
	The brush roller tangled with hairs or fibers	Clean the brush roller
Abnormal motor sounds	The appliance is blocked (i.e. the tube, suction mouth or some other parts)	Remove blockages
Battery won't charge	The adaptor is not correctly inserted	Reinsert the adaptor correctly
	Insufficient contact between the main body and battery	Check the main body and battery are correctly placed
	The adaptor is not designed for PURE ONE S12	Use the original adaptor

Problem	Possible cause	Solution
Brush roller tangled indicator blinking 	The brush roller is blocked	Remove blockages
Power indicator blinking 	Motor failure	Remove blockages, or restart
Air channel blocked indicator blinking 	The appliance is blocked, or full of dust in filter and dustbin	Remove blockages, clean the filter and dustbin
Dust sensor malfunction indicator blinking 	1. The sensor inside the dustbin is blocked 2. The dustbin is not installed	1. Clean the dust on the inner sensor 2. Install the dustbin correctly
WiFi indicator is off 	WiFi is not connected	Follow the in-app guide to connect to WiFi
Battery indicator blinking red on work 	The battery is overheated	Remove the battery pack and let it cool
Battery indicator & Battery icon blinking red during charging  	Abnormal charging condition	The adaptor is not designed for PURE ONE S12
Battery icon on screen blinking green during charging 	No battery pack or battery pack installed improperly during charging	Install the battery on the main body properly

Note:

If the above troubleshooting guide fails to provide a solution, please visit our website www.tineco.com for further support.

Warranty

2-YEAR LIMITED WARRANTY

- Only applies to purchases made from authorized retailers of Tineco.
- Is subject to the adherence of the requirements outlined in this instruction manual, and is subject to further conditions outlined below.

WHAT IS COVERED?

- Your Tineco appliance has a 2-year warranty against original defects in material and workmanship, when used for private household purposes in accordance with the Tineco Instruction Manual. Motorized accessories and battery bought separately come with a 1-year warranty.
- This warranty provides, at no extra cost to you, all labor and parts necessary to ensure your appliance is in proper operating condition during the warranty period.
- This warranty will only be valid if the appliance is used in the country in which it was sold.

EN

WHAT IS NOT COVERED?

Tineco shall not be liable for costs, damages or repairs incurred as a result of:

- Appliances purchased from an unauthorized dealer.
- Careless operation or handling, misuse, abuse and/or lack of maintenance or use not in accordance with the Tineco Instruction Manual.
- Use of the appliance other than for normal domestic purposes, e.g. for commercial or rental purposes.
- Use of parts not in accordance with the Tineco Instruction Manual.
- Use of parts and accessories other than those produced or recommended by Tineco.
- External factors unrelated to product quality and use, such as weather, modifications, accidents, electrical outages, power surges or acts of God.
- Repairs or alterations carried out by unauthorized parties or agents.
- Failing to clear blockage and other hazardous material from the appliance.
- Normal wear and tear, including normal wearing parts, such as clear bin, belt, filter, HEPA, brush bar, and power cord (or where external damage or abuse is diagnosed), carpet or floor damage due to use not in accordance with manufacturer's instructions or failure to turn the brush bar off when necessary.
- Reduction in battery discharge time due to battery age or use.

WARRANTY LIMITATIONS

- Any implied warranties relating to your appliance including but not limited to warranty of merchantability or warranty of fitness for a particular purpose, are limited to the duration of this warranty.
- Warranty coverage applies to the original owner and to the original battery only and is not transferable.
- This limited warranty gives you specific legal rights. You may also have other rights which vary by region.
- Manufacturer's warranties may not apply in all cases, depending on factors such as use of the product, where the product was purchased, or who you purchased the product from. Please review the warranty carefully, and contact the manufacturer if you have any questions.

WARRANTY SERVICE

Register: We highly recommend that upon purchase, you register your appliance on the Tineco official website (www.tineco.com) and enjoy exclusive benefits. To register, please enter the last 11 digits of the serial number (found on the base of the vacuum unit).

Failure to register your product won't diminish your warranty rights.

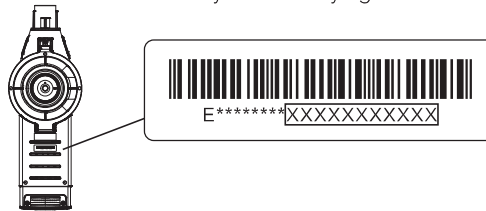

How to Claim: Please retain your proof of purchase. To make a claim under our Limited Warranty, you need to provide your serial number and the original purchase receipt with the purchase date and order number on it.

All work will be carried out by Tineco or an authorized agent.

Any replaced defective parts will become the property of Tineco.

Service under this warranty will not extend the period of this warranty.

Visit Tineco website www.tineco.com
for expert customer service.