

EMC TEST REPORT

Application No. : LH-220902274298
Applicant : Zhongshan Hengsong Lighting Co. , Ltd.

Equipment Under Test (EUT)

EUT Name : Ceiling lamp
Model No. : RY0228
Serial No. : See page 4
Brand name : N/A
Receipt Date : 2022-08-26
Test Date : 2022-08-26 to 2022-09-06
Issue Date : 2022-09-09
Standards : EN IEC 55015:2019/A11:2020
EN IEC 61000-3-2: 2019/A1: 2021
EN 61000-3-3: 2013/A1:2019
EN 61547: 2009

Conclusions : **PASS**

In the configuration tested, the EUT complied with the standards specified above. The EUT technically complies with the 2014/30/EU directive requirements.

Test/Witness Engineer :



Approved & Authorized :

Handwritten signature: Jack su



This report details the results of the testing carried out on one sample. The results contained in this test report do not relate to other samples of the same product. The manufacturer should ensure that all products in series production are in conformity with the product sample detailed in the report.

TABLE OF CONTENTS

1. General Information	4
1.1. Client Information	4
1.2. General Description of EUT (Equipment Under Test)	4
1.3. Block Diagram Showing the Configuration of System Tested	4
1.4. Description of Support Units	4
1.5. Performance Criterion	4
1.6. Test Facility	5
2. Test Results Summary	6
3. Test Equipment Used	7
4. Conducted Emission Test	9
4.1. Test Standard and Limit	9
4.2. Test Setup	9
4.3. Test Procedure	9
4.4. Test Condition	10
4.5. Test Data	10
5. Magnetic field emission Measurement	13
5.1. Test Standard and Limit	13
5.2. Test Setup	13
5.3. Test Procedure	13
5.4. Test Condition	14
5.5. Test Data	14
6. Radiated Disturbance Test	18
6.1. Test Standard and Limit	18
6.2. Test Setup	18
6.3. Test Procedure	18
6.4. Test Condition	19
6.5. Test Data	19
7. Harmonic Current Emission Test	22
7.1. Test Standard and Limit	22
7.2. Test Setup	22
7.3. Test Procedure	22
7.4. Test Condition	23
7.5. Test Data	23
8. Voltage Fluctuation and Flicker test	27
8.1. Test Standard and Limit	27
8.2. Test Setup	27
8.3. Test Procedure	27
8.4. Test Condition	28
8.5. Test Data	28
9. Electrostatic Discharge Immunity Test	30
9.1. Test Requirements	30
9.2. Test Setup	30
9.3. Test Procedure	30
9.4. Test Data	31

10. Radiated Electromagnetic Field Immunity Test.....	33
10.1. Test Requirements	33
10.2. Test Setup	33
10.3. Test Procedure	33
10.4. Test Data	34
11. Electrical Fast Transient/Burst Test.....	36
11.1. Test Requirements	36
11.2. Test Setup	36
11.3. Test Procedure	36
11.4. Test Data	37
12. Surge Immunity Test.....	39
12.1. Test Requirements	39
12.2. Test Setup	39
12.3. Test Procedure	39
12.4. Test Data	40
13. Conducted Immunity Test.....	42
13.1. Test Requirements	42
13.2. Test Setup	42
13.3. Test Procedure	42
13.4. Test Data	43
14. Power frequency Magnetic Field Immunity Test.....	45
14.1. Test Requirements	45
14.2. Test Setup	45
14.3. Test Procedure	45
14.4. Test Data	46
15. Voltage Dips and Interruptions Immunity Test.....	47
15.1. Test Requirements	47
15.2. Test Setup	47
15.3. Test Procedure	47
15.4. Test Data	47
16. Photographs - Constructional Details	49

1. General Information

1.1. Client Information

Applicant	:	Zhongshan Hengsong Lighting Co. , Ltd.
Address	:	NO.18 East 3rd Lane, Central Road,GangNan , GuZhen Town Zhongshan City,Guangdong
Manufacturer	:	Zhongshan Hengsong Lighting Co. , Ltd.
Address	:	NO.18 East 3rd Lane, Central Road,GangNan , GuZhen Town Zhongshan City,Guangdong

1.2. General Description of EUT (Equipment Under Test)

EUT Name	:	Ceiling lamp
Model No.	:	RY0228
Serial No.	:	RY0218, RY0258, RY0268, RY0288, RY0318, RY0188, RY0168, RY0198, RY0208
Brand name	:	N/A
Power Supply	:	AC 180-256V, 0.1-0.5A, 50-60Hz
Remark: All above models are identical in schematic, structure and critical components except for different active power, therefore, EMI and EMS testing was performed with RY0228 only.		

1.3. Block Diagram Showing the Configuration of System Tested

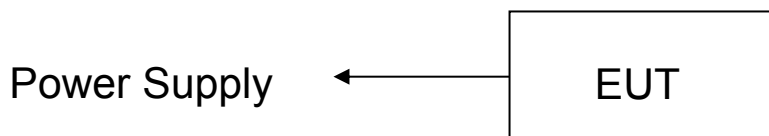

1.4. Description of Support Units

The EUT has been tested as an independent unit.

1.5. Performance Criterion

Criterion A: The equipment shall continue to operate as intended without operator intervention. No degradation of performance or loss of function is allowed below a performance level specified by the manufacturer when the equipment is used as intended.

Criterion B: After the test, the equipment shall continue to operate as intended without operator intervention. No degradation of performance or loss of function is allowed, after the application of the phenomena below a performance level specified by the manufacturer, when the equipment is used as intended.

Criterion C: Loss of function is allowed, provided the function is self-recoverable, or can

be restored by the operation of the controls by the user in accordance with the manufacturer's instructions.

1.6. Test Facility

The testing report were performed by the Shenzhen LH Testing Technology Co., Ltd., in their facilities located at 106 and 107, building B15, Yintian Industrial Zone, Yantian community, Xixiang street, Bao'an District, Shenzhen.

2. Test Results Summary

EMISSION (EN IEC 55015:2019/A11:2020)		
Description of test item	Standards	Results
Conducted Disturbance at Mains Terminals	EN IEC 55015:2019/A11:2020	Pass
Magnetic Emission	EN IEC 55015:2019/A11:2020	Pass
Radiated Disturbance	EN IEC 55015:2019/A11:2020	Pass
Harmonic Current Emissions	EN IEC 61000-3-2: 2019/A1: 2021	Pass
Voltage Fluctuation and Flicker	EN 61000-3-3: 2013/A1:2019	Pass
IMMUNITY (EN 61547: 2009)		
Description of Test Item	Basic Standards	Results
Electrostatic Discharge (ESD)	EN 61000-4-2: 2009	Pass
Radio-frequency, Continuous Radiated Disturbance	EN IEC 61000-4-3:2020	Pass
EFT/B Immunity	EN 61000-4-4: 2012	Pass
Surge Immunity	EN 61000-4-5: 2014/A1:2017	Pass
Conducted RF Immunity	EN 61000-4-6: 2014	Pass
Power Frequency Magnetic Field	EN 61000-4-8: 2010	Pass
Voltage Dips and Interruptions, 100% Reduction	EN IEC 61000-4-11:2020	Pass
Voltage Dips and Interruptions, 30% reduction		Pass

3. Test Equipment Used

3.1. Test Equipment Used to Measure Conducted Emission					
No.	Equipment	Manufacturer	Model No.	Last Cal.	Cal. Interval
LH-EMC001	EMI Test Receiver	Rohde & Schwarz	ESCS30	Dec. 30, 2021	1 Year
LH-EMC002	AMN	Rohde & Schwarz	ENV216	Dec. 30, 2021	1 Year
LH-EMC003	AMN	SCHWARZBECK	NNBL 8226-2	Dec. 30, 2021	1 Year
3.2. Test Equipment Used to Measure Magnetic Field Emission					
No.	Equipment	Manufacturer	Model No.	Last Cal.	Cal. Interval
LH-EMC001	EMI Test Receiver	Rohde & Schwarz	ESCS30	Dec. 30, 2021	1 Year
LH-EMC027	Triple-Loop Antenna	EVERFINE	LLA-2	Dec. 30, 2021	1 Year
3.3. Test Equipment Used to Measure Radiated Emission					
No.	Equipment	Manufacturer	Model No.	Last Cal.	Cal. Interval
LH-EMC004	EMI Test Receiver	Rohde & Schwarz	ESI26	Dec. 30, 2021	1 Year
LH-EMC005	Bilog Antenna	SCHWARZBECK	VULB9163	Dec. 30, 2021	1 Year
LH-EMC006	Positioning Controller	C&C	CC-C-1F	N/A	N/A
3.4. Test Equipment Used to Measure Harmonic Current/ Voltage Fluctuation and Flicker					
No.	Equipment	Manufacturer	Model No.	Last Cal.	Cal. Interval
LH-EMC007	Harmonic Flicker Test System	CI	5001ix-CTS-400	Dec. 30, 2021	1 Year
3.5. Test Equipment Used to Measure Electrostatic Discharge Immunity					
No.	Equipment	Manufacturer	Model No.	Last Cal.	Cal. Interval
LH-EMC008	ESD Tester	TESEQ	NSG437	Dec. 30, 2021	1 Year
3.6. Test Equipment Used to Measure Conducted Immunity					
No.	Equipment	Manufacturer	Model No.	Last Cal.	Cal. Interval
LH-EMC009	RF Generator	FRANKONIA	CIT-10/75	Dec. 30, 2021	1 Year
LH-EMC010	Attenuator	FRANKONIA	59-6-33	Dec. 30, 2021	1 Year
LH-EMC011	M-CDN	LUTHI	M2/M3	Dec. 30, 2021	1 Year
LH-EMC012	CDN	LUTHI	AF2	Dec. 30, 2021	1 Year

LH-EMC013	EM Injection Clamp	LUTHI	EM101	Dec. 30, 2021	1 Year
3.7. Test Equipment Used to Measure Radio Frequency Electromagnetic Fields Immunity					
No.	Equipment	Manufacturer	Model No.	Last Cal.	Cal. Interval
LH-EMC014	Signal Generator	Rohde & Schwarz	SMT03	Dec. 30, 2021	1 Year
LH-EMC015	Power Meter	Rohde & Schwarz	NRVD	Dec. 30, 2021	1 Year
LH-EMC016	Voltage Probe	Rohde & Schwarz	URV5-Z2	Dec. 30, 2021	1 Year
LH-EMC017	Voltage Probe	Rohde & Schwarz	URV5-Z2	Dec. 30, 2021	1 Year
LH-EMC018	Power Amplifier	AR	150W1000	Dec. 30, 2021	1 Year
LH-EMC019	Bilog Antenna	Chase	CBL6111C	Dec. 30, 2021	1 Year
3.8. Test Equipment Used to Measure Electrical Fast Transient/Burst Immunity					
No.	Equipment	Manufacturer	Model No.	Last Cal.	Cal. Interval
LH-EMC020	Simulator	EMTEST	UCS500N5	Dec. 30, 2021	1 Year
LH-EMC021	Auto-transformer	EMTEST	V4780S2	Dec. 30, 2021	1 Year
3.9. Test Equipment Used to Measure Surge Immunity					
No.	Equipment	Manufacturer	Model No.	Last Cal.	Cal. Interval
LH-EMC022	Simulator	EMTEST	UCS500N5	Dec. 30, 2021	1 Year
LH-EMC023	Coupling Clamp	EMTEST	HFK	Dec. 30, 2021	1 Year
3.10. Test Equipment Used to Measure Voltage Dips and Interruptions Immunity					
No.	Equipment	Manufacturer	Model No.	Last Cal.	Cal. Interval
LH-EMC022	Simulator	EMTEST	UCS500N5	Dec. 30, 2021	1 Year
LH-EMC023	Coupling Clamp	EMTEST	HFK	Dec. 30, 2021	1 Year
3.11. Test Equipment Used to Measure Power frequency Magnetic Field					
No.	Equipment	Manufacturer	Model No.	Last Cal.	Cal. Interval
LH-EMC026	Power Frequency Magnetic Field Generator	EVERFINE	EMS61000-8K	Dec. 30, 2021	1 Year

4. Conducted Emission Test

4.1. Test Standard and Limit

4.1.1. Test Standard

EN IEC 55015:2019/A11:2020.

4.1.2. Test Limit

Conducted Disturbance Test Limit (Class B)

Frequency	Maximum RF Line Voltage (dB μ V)	
	Quasi-peak Level	Average Level
9kHz~50kHz	110	--
50kHz ~150kHz	90 to 80*	--
150kHz~500kHz	66 ~ 56 *	56 ~ 46 *
500kHz~5MHz	56	46
5MHz~30MHz	60	50

Remark: 1. *Decreasing linearly with logarithm of the frequency
 2. At the transition frequency, the lower limit applies.
 3. For electrodeless lamps and luminaries, the limit in the frequency range of 2,51 MHz to 3,0 MHz is 73 dB(μ V) quasi-peak and 63 dB(μ V) average

4.2. Test Setup

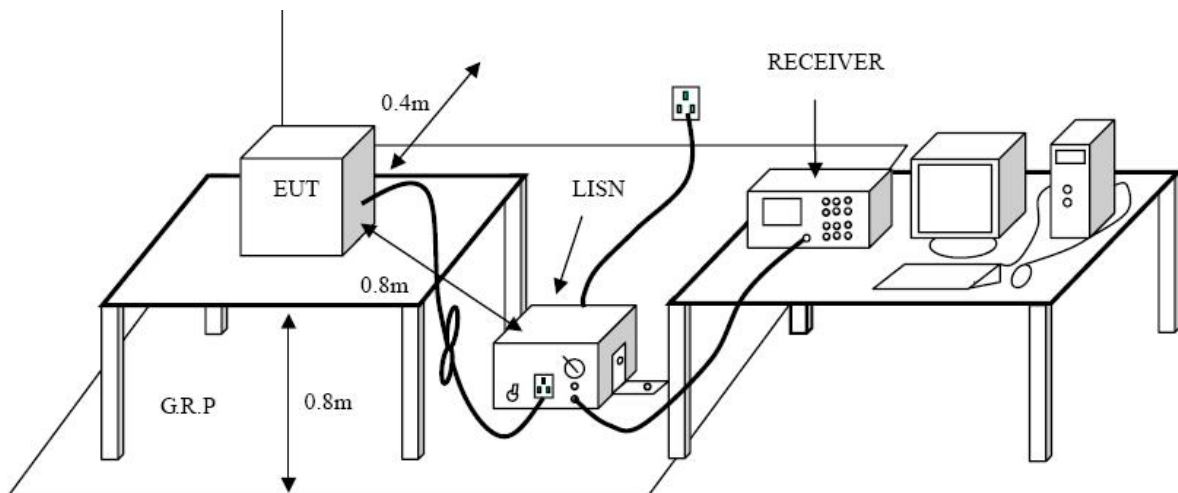

4.3. Test Procedure

The EUT was placed 0.4 meters from the horizontal ground plane with EUT being connected to the power mains through a line impedance stabilization network (LISN). All other support equipments powered from additional LISN(s). The LISN provide 50 Ohm/ 50uH of coupling impedance for the measuring instrument.

Interconnecting cables that hang closer than 40 cm to the ground plane shall be folded back and forth in the center forming a bundle 30 to 40 cm long.

I/O cables that are not connected to a peripheral shall be bundled in the center. The end of the cable may be terminated, if required, using the correct terminating impedance. The overall length shall not exceed 1 m.

LISN at least 80 cm from nearest part of EUT chassis.

The bandwidth of EMI test receiver is set at 9kHz, and the test frequency band is from 9KHz to 30MHz.

4.4. Test Condition

Temperature	:	25 °C
Relative Humidity	:	48 %
Pressure	:	1010 hPa
Test Power	:	AC 230V/50Hz

4.5. Test Data

Please refer to the following pages.



Operating Mode: ON
Test Specification: L

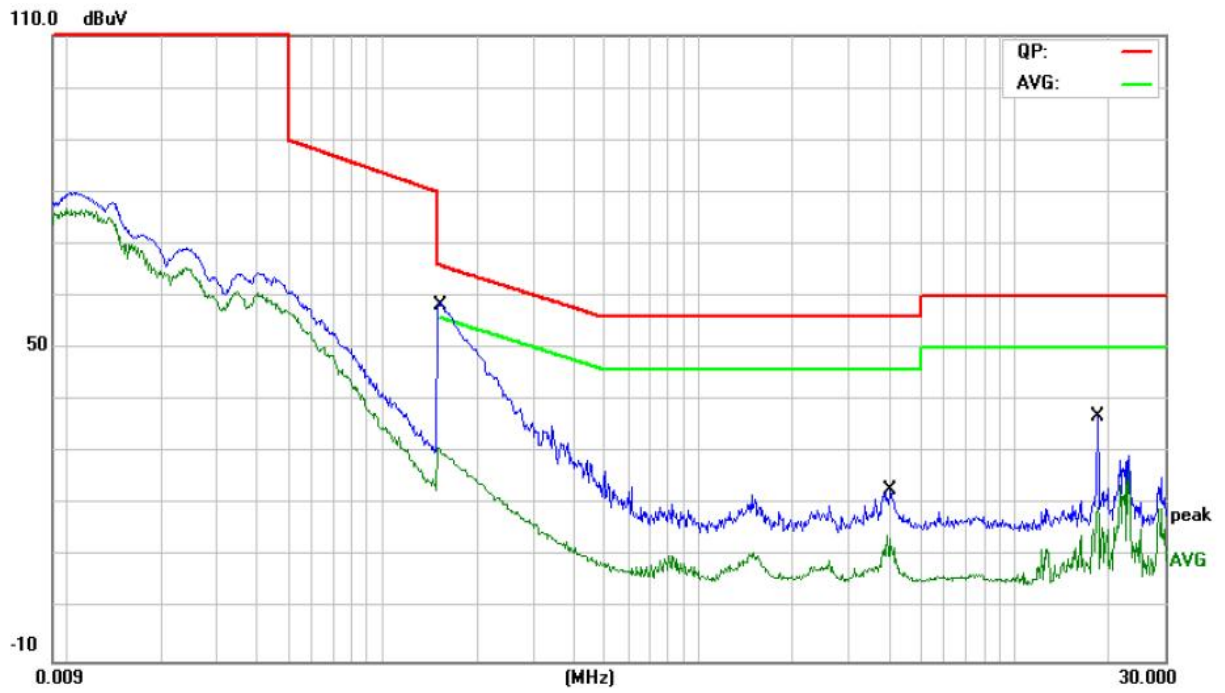

No.	Mk.	Freq. MHz	Reading Level dBuV	Correct Factor dB	Measure- ment dBuV	Limit dBuV	Over dB	Detector	Comment
1	*	0.1500	38.58	10.90	49.48	65.99	-16.51	QP	
2		0.1500	19.24	10.90	30.14	55.99	-25.85	AVG	
3		4.0580	5.46	9.41	14.87	56.00	-41.13	QP	
4		4.0580	-0.06	9.41	9.35	46.00	-36.65	AVG	
5		18.3060	13.03	10.07	23.10	60.00	-36.90	QP	
6		18.3060	9.00	10.07	19.07	50.00	-30.93	AVG	



Operating Mode: ON
Test Specification: N

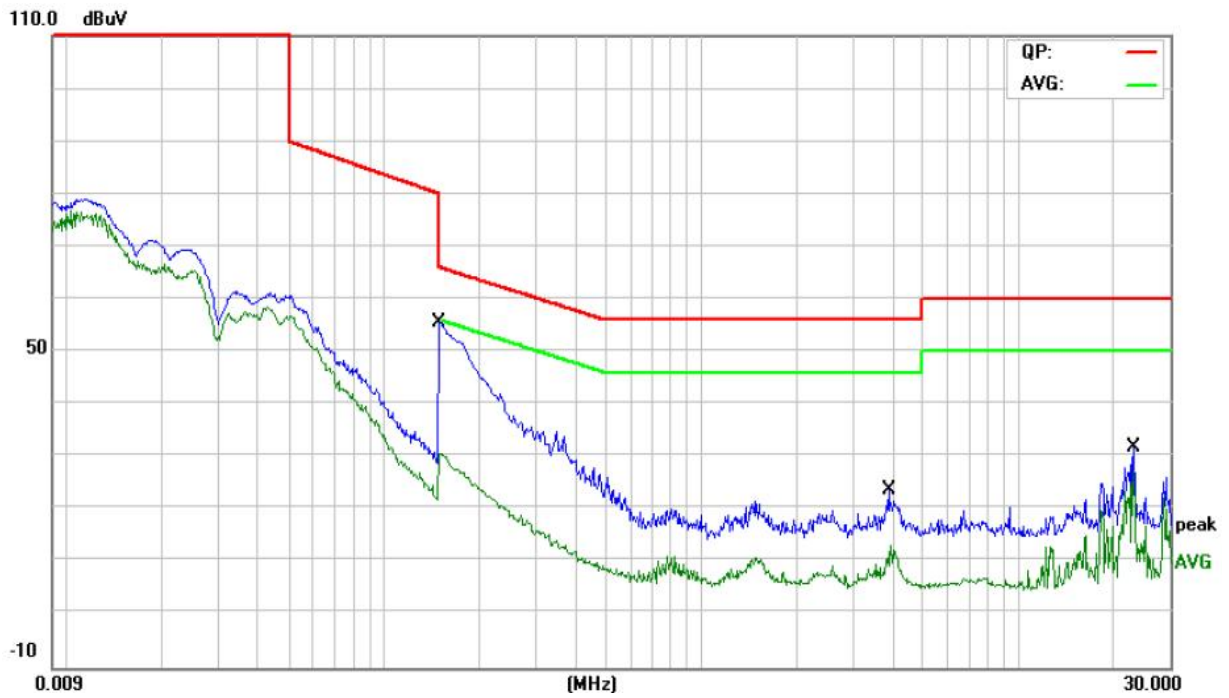

No.	Mk.	Freq.	Reading Level	Correct Factor	Measurement	Limit	Over	Detector	Comment
		MHz	dBuV	dB	dBuV	dBuV	dB		
1	*	0.1500	37.92	10.93	48.85	65.99	-17.14	QP	
2		0.1500	19.01	10.93	29.94	55.99	-26.05	AVG	
3		3.9060	6.92	9.45	16.37	56.00	-39.63	QP	
4		3.9060	2.15	9.45	11.60	46.00	-34.40	AVG	
5		23.1299	20.16	10.22	30.38	60.00	-29.62	QP	
6		23.1299	16.88	10.22	27.10	50.00	-22.90	AVG	

5. Magnetic field emission Measurement

5.1. Test Standard and Limit

5.1.1. Test Standard

EN IEC 55015:2019/A11:2020.

5.1.2. Test Limit

Frequency			Limits for loop diameter (dB μ A)
			2m
9KHz	~	70KHz	88
70KHz	~	150KHz	88 ~ 58*
150KHz	~	2.2MHz	58 ~ 26*
2.2MHz	~	3.0MHz	58
3.0MHz	~	30MHz	22

Remark: 1. At the transition frequency the lower limit applies.
2. * Decreasing linearly with logarithm of the frequency.

5.2. Test Setup

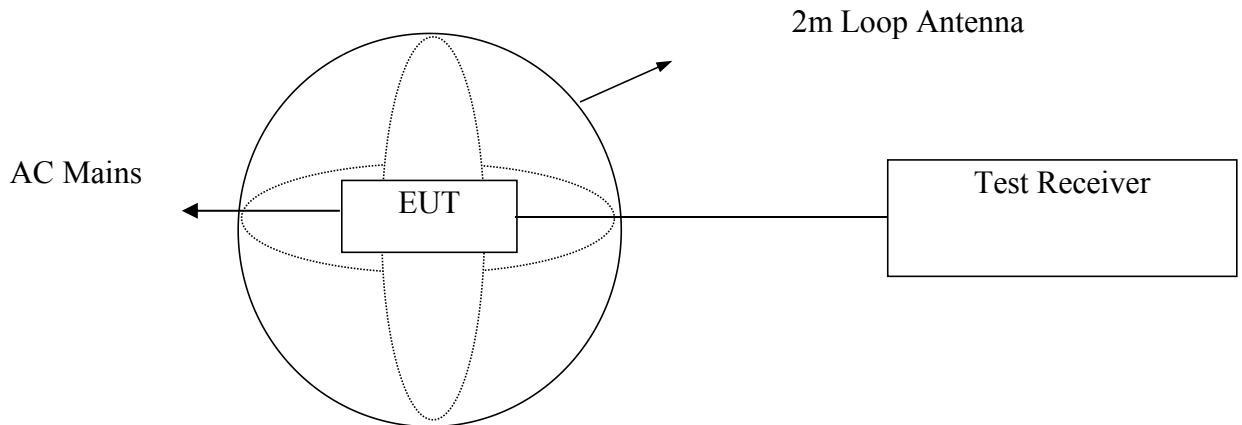

5.3. Test Procedure

The EUT is placed on a wood table in the center of a loop antenna. The induced current in the loop antenna is measured by means of a current probe and the test receiver. Three field components are checked by means of a coaxial switch.

The frequency range from 9KHz to 30MHz is investigated. The receiver is measured with the quasi-peak detector. For frequency band 9KHz to 150KHz, the bandwidth of the field strength meter is set at 200Hz. For frequency band 150KHz to 30MHz, the bandwidth is set at 9KHz.

5.4. Test Condition

Temperature	:	25 °C
Relative Humidity	:	48 %
Pressure	:	1010 hPa
Test Power	:	AC 230V/50Hz

5.5. Test Data

Please refer to the following pages.

Operating Mode: ON
Test Specification: X Direction

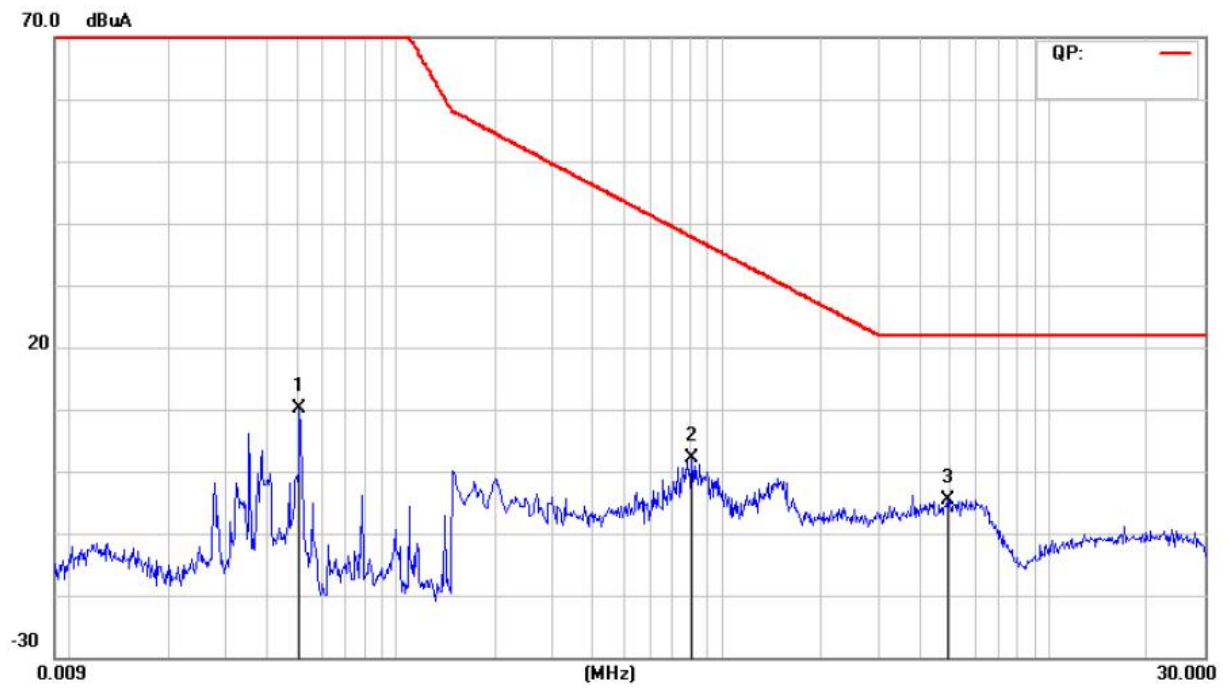

No.	Mk.	Freq. MHz	Reading Level dBuA	Correct Factor dB	Measure- ment dBuA	Limit dBuA	Over dB	Detector	Comment
1		0.0509	-10.56	20.76	10.20	88.00	-77.80	peak	
2		0.8059	-18.79	20.81	2.02	37.79	-35.77	peak	
3	*	4.8900	-26.69	22.08	-4.61	22.00	-26.61	peak	



Operating Mode: ON
Test Specification: Y Direction

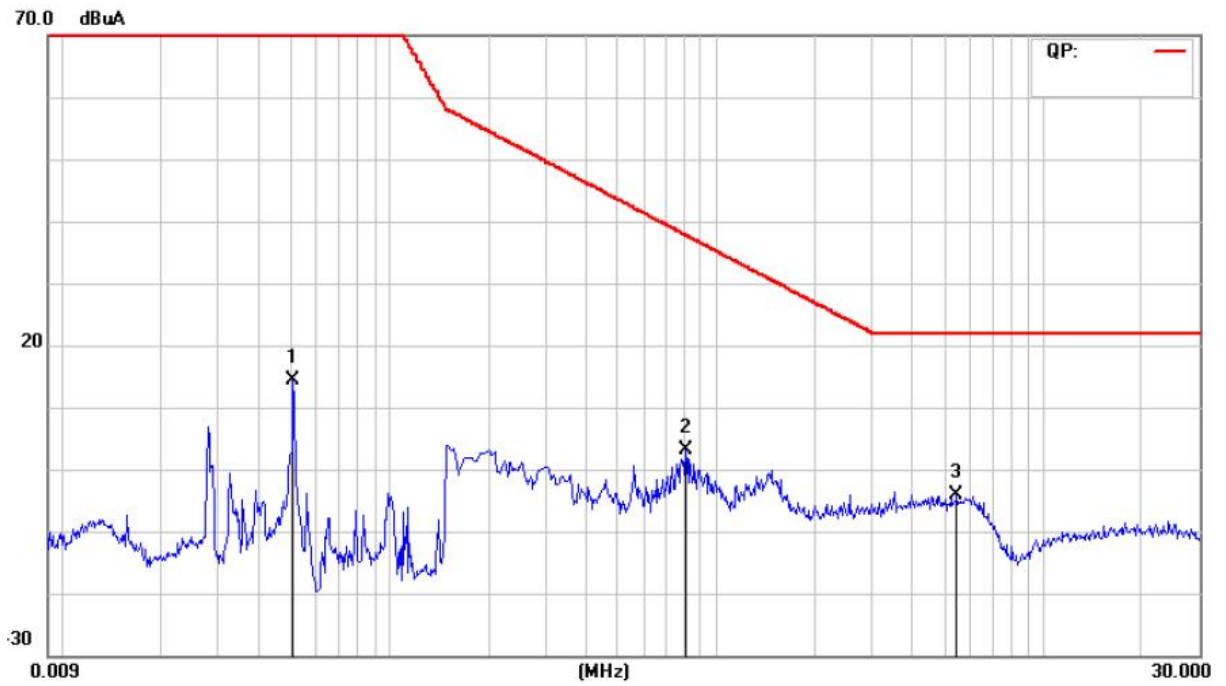

No.	Mk.	Freq. MHz	Reading Level dBuA	Correct Factor dB	Measure- ment dBuA	Limit dBuA	Over dB	Detector	Comment
1		0.0509	-3.36	17.70	14.34	88.00	-73.66	peak	
2		0.8059	-17.56	20.71	3.15	37.79	-34.64	peak	
3	*	5.4420	-26.84	22.62	-4.22	22.00	-26.22	peak	



Operating Mode: ON
Test Specification: Z Direction

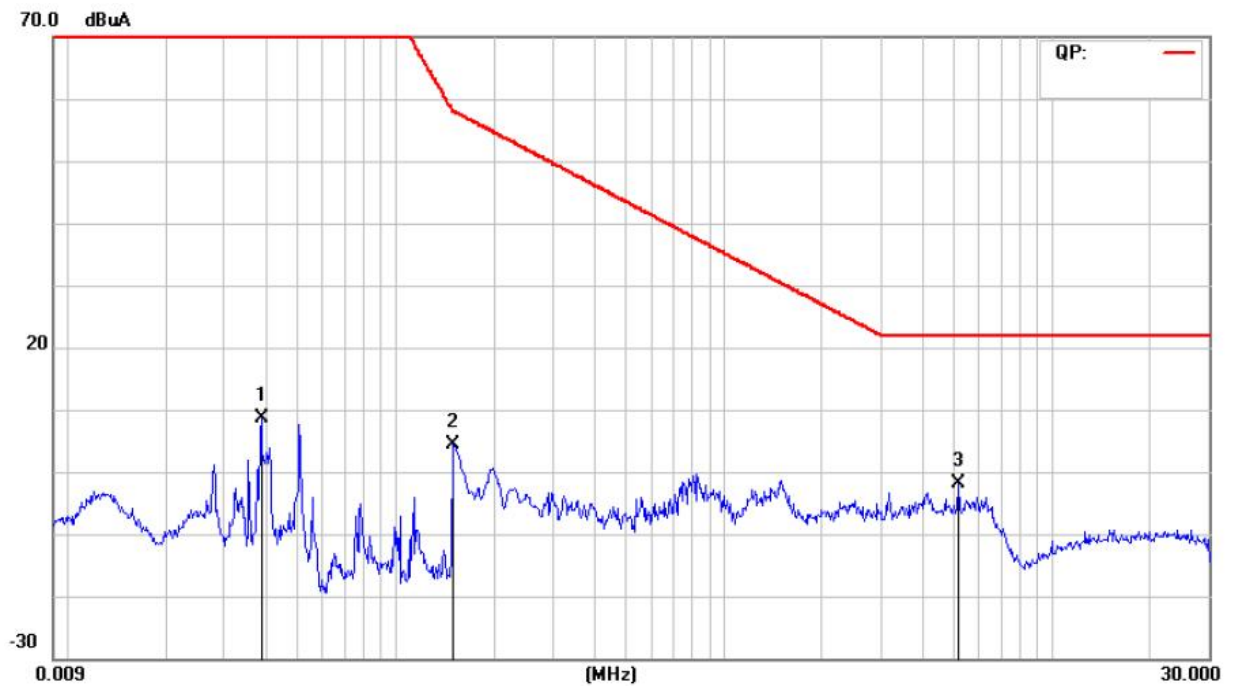

No.	Mk.	Freq. MHz	Reading Level dBuA	Correct Factor dB	Measure- ment dBuA	Limit dBuA	Over dB	Detector	Comment
1		0.0388	-10.77	19.51	8.74	88.00	-79.26	peak	
2		0.1500	-15.41	19.70	4.29	57.99	-53.70	peak	
3	*	5.1740	-24.14	22.30	-1.84	22.00	-23.84	peak	

6. Radiated Disturbance Test

6.1. Test Standard and Limit

6.1.1. Test Standard

EN IEC 55015:2019/A11:2020.

6.1.2. Test Limit

Radiated Disturbance Test Limit (Class B)

Frequency	Limit (dB μ V/m)
	Quasi-peak Level
30MHz~230MHz	40
230MHz~300MHz	47

Remark: 1. The lower limit shall apply at the transition frequency.
2. The test distance is 3m.

6.2. Test Setup

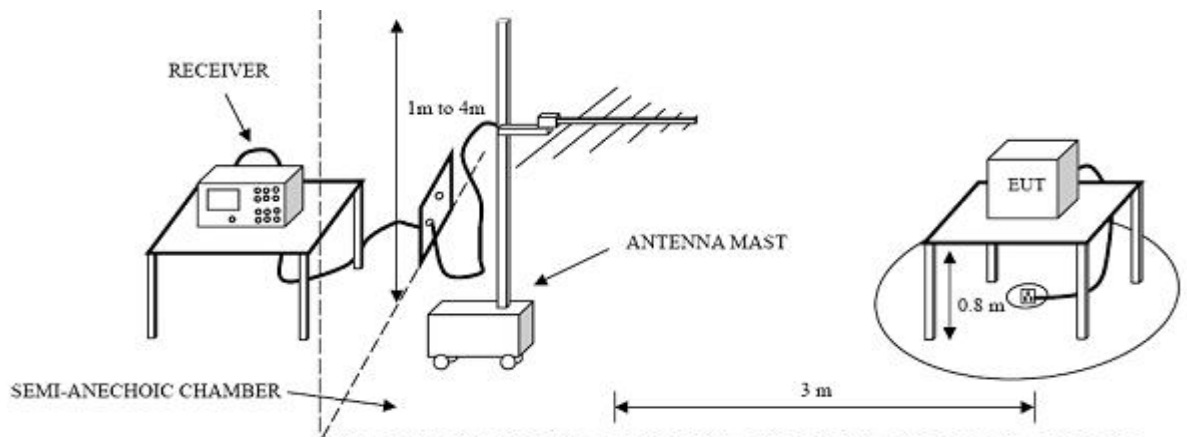

6.3. Test Procedure

The EUT was placed on the top of a rotating table 0.8 meters above the ground at a 3m. The table was rotated 360 degrees to determine the position of the highest radiation.

The height of the equipment or of the substitution antenna shall be 0.8 m; the height of the test antenna shall vary between 1 m to 4 m. Both horizontal and vertical polarizations of the antenna are set to make the measurement.

The initial step in collecting radiated emission data is a spectrum analyzer peak detector mode pre-scanning the measurement frequency range. Significant peaks are then marked and then Quasi Peak detector mode re-measured.

If the Peak Mode measured value compliance with and lower than Quasi Peak Mode Limit, the EUT shall be deemed to meet QP Limits and then no additional QP Mode

measurement performed.

6.4. Test Condition

Temperature	:	25 °C
Relative Humidity	:	48 %
Pressure	:	1010 hPa
Test Power	:	AC 230V/50Hz

6.5. Test Data

Please refer to the following pages.



Operating Mode: ON
Test Specification: Horizontal

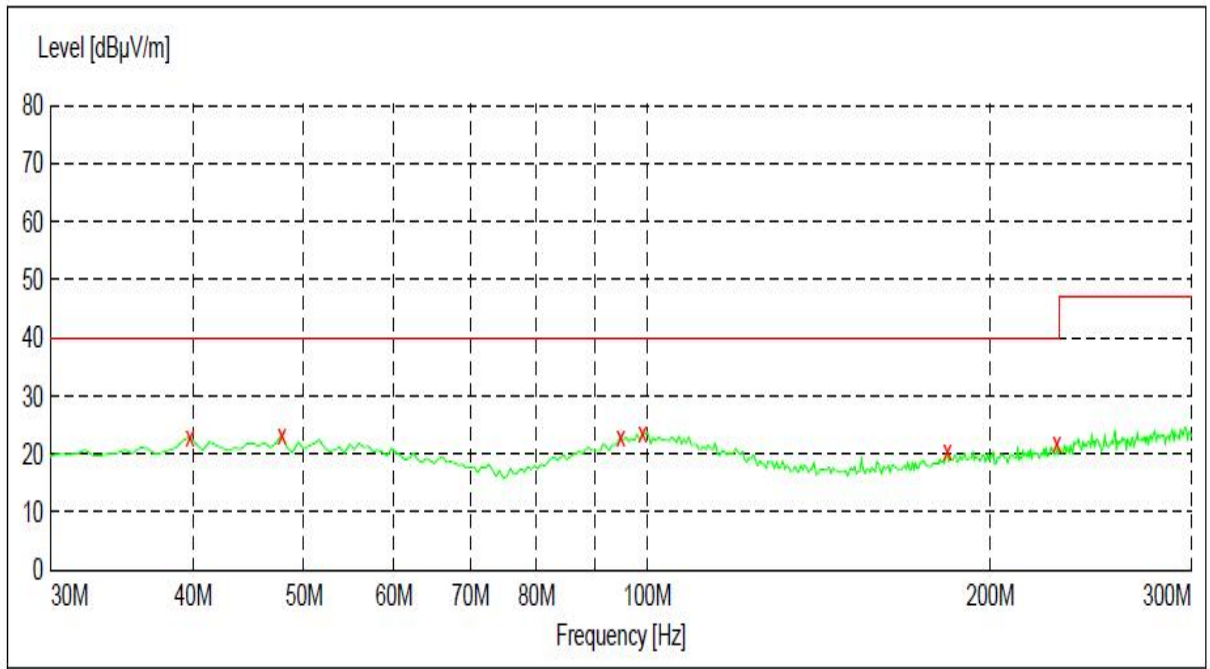

Frequency MHz	Level dBμV/m	Transd dB	Limit dBμV/m	Margin dB	Det.	Height cm	Azimuth deg	Polarization
39.720000	22.90	15.8	40.0	17.1	---	100.0	0.00	HORIZONTAL
47.820000	23.40	15.8	40.0	16.6	---	100.0	0.00	HORIZONTAL
94.800000	23.10	17.1	40.0	16.9	---	100.0	0.00	HORIZONTAL
99.120000	23.70	17.5	40.0	16.3	---	100.0	0.00	HORIZONTAL
183.360000	20.60	14.2	40.0	19.4	---	100.0	0.00	HORIZONTAL
228.720000	21.90	16.0	40.0	18.1	---	100.0	0.00	HORIZONTAL



Operating Mode: ON
Test Specification: Vertical

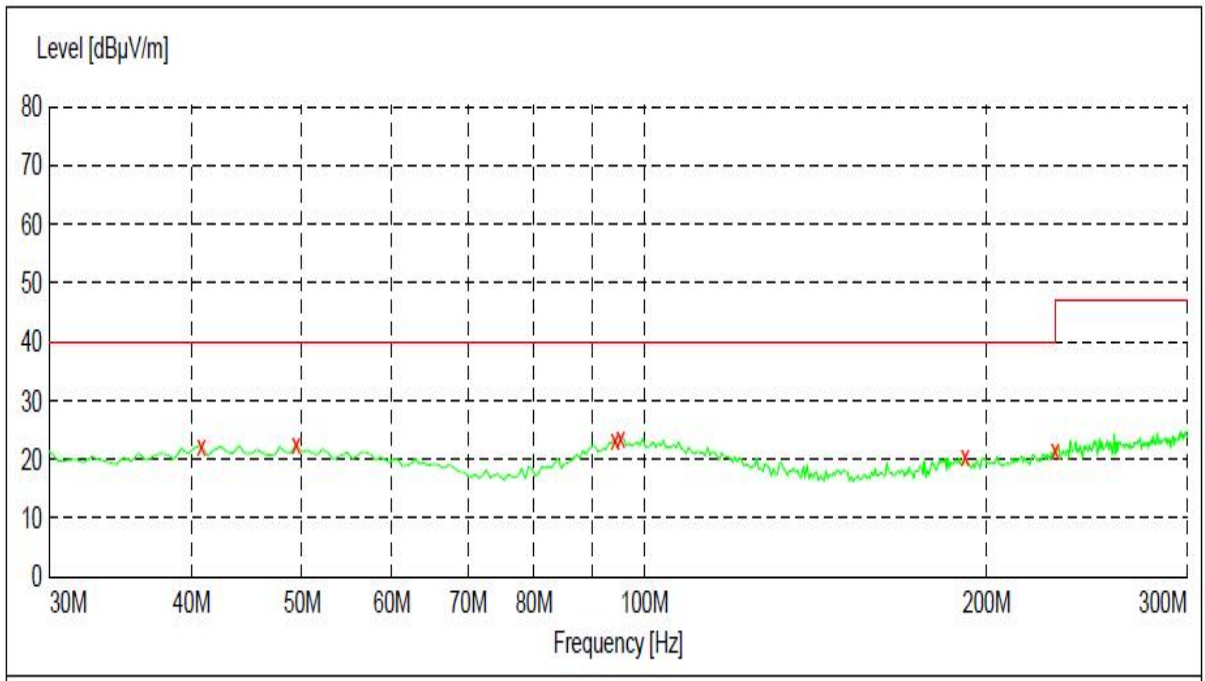

Frequency MHz	Level dBµV/m	Transd dB	Limit dBµV/m	Margin dB	Det.	Height cm	Azimuth deg	Polarization
40.800000	22.40	15.9	40.0	17.6	---	100.0	0.00	VERTICAL
49.440000	22.70	15.8	40.0	17.3	---	100.0	0.00	VERTICAL
94.260000	23.50	16.9	40.0	16.5	---	100.0	0.00	VERTICAL
95.340000	23.70	17.1	40.0	16.3	---	100.0	0.00	VERTICAL
191.460000	20.60	14.8	40.0	19.4	---	100.0	0.00	VERTICAL
229.800000	21.80	16.1	40.0	18.2	---	100.0	0.00	VERTICAL

7. Harmonic Current Emission Test

7.1. Test Standard and Limit

7.1.1. Test Standard

EN IEC 61000-3-2: 2019/A1: 2021

7.1.2. Limits

Harmonic Current Test Limit (Class C)

Harmonic order (n)	Maximum permissible harmonic current Expressed as a percentage of the input Current at the fundamental frequency %
2	2
3	$30.\lambda$
5	10
7	7
9	5
$15 \leq n \leq 39$ (odd harmonics only)	3

Remark: λ is the circuit power factor

7.2. Test Setup

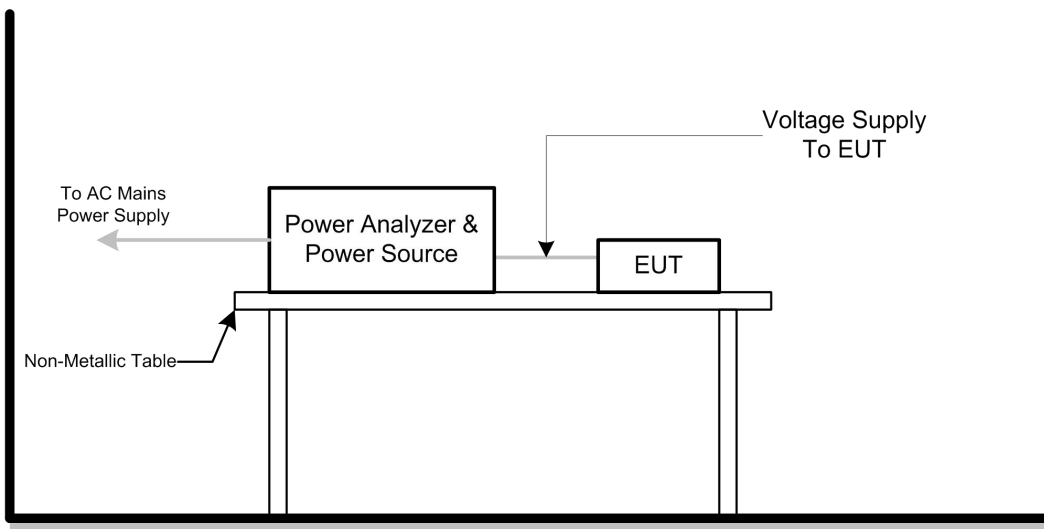

7.3. Test Procedure

The EUT was placed on the top of a wooden table 0.8 meters above the ground and operated to produce the maximum harmonic components under normal operating

conditions.

The classification of EUT is according to section 5 of EN IEC 61000-3-2. The EUT is classified as follows:

Class A: Balanced three-phase equipment, Household appliances excluding equipment as Class D, Tools excluding portable tools, Dimmers for incandescent lamps, audio equipment, equipment not specified in one of the three other classes.

Class B: Portable tools. Arc welding equipment which is not professional equipment.

Class C: Lighting equipment.

Class D: Equipment having a specified power less than or equal to 600 W of the following types: Personal computers and personal computer monitors and television receivers.

7.4. Test Condition

Temperature	:	25 °C
Relative Humidity	:	48 %
Pressure	:	1010 hPa
Test Power	:	AC 230V/50Hz

7.5. Test Data

Please refer to the following pages.

Harmonics – Class-C per Ed. 3.0 (2014) (Run time)

Test category: Class-C per Ed. 3.0 (2014) (European limits)
 Test Margin: 100 Tested by: LH
 Start time: 10:41:24 End time: 10:51:45
 Test duration (min): 10 Data file name: H-000477.cts_data
 Customer: Customer

Test Result: Pass Source qualification: Normal

Current & voltage waveforms

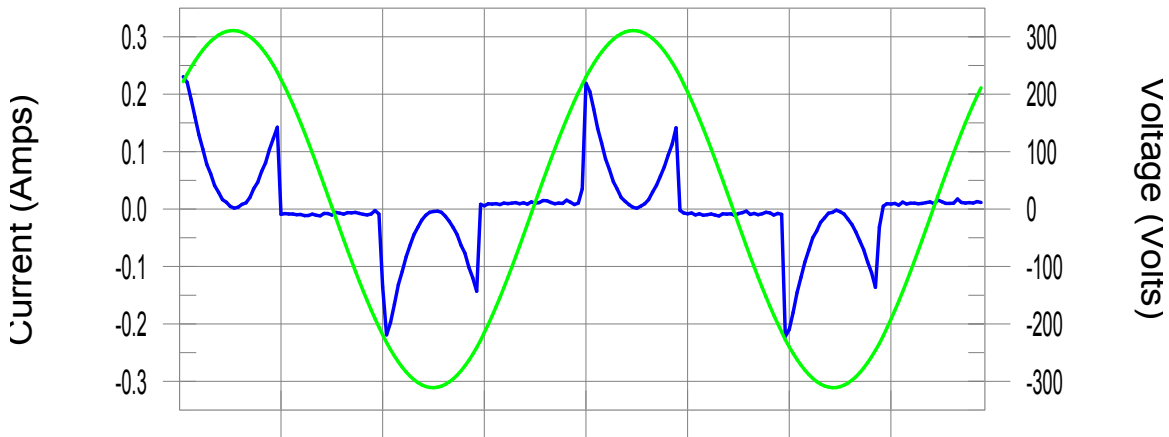

Harmonics and Class A limit line European Limits

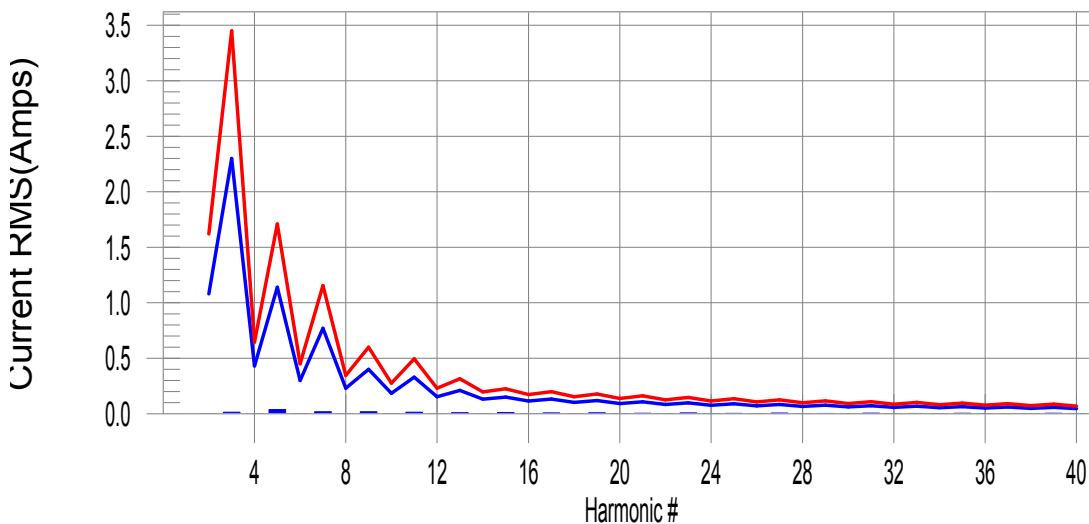

Test result: Pass Worst harmonic was #27 with 7.12% of the limit.

Current Test Result Summary (Run time)

Test category: Class-C per Ed. 3.0 (2014) (European limits)
 Test Margin: 100 Tested by: LH
 Start time: 10:41:24 End time: 10:51:45
 Test duration (min): 10 Data file name: H-000477.cts_data
 Customer: Customer

Test Result: Pass Source qualification: Normal
 THC(A): 0.05 I-THD(%): 116.01 POHC(A): 0.009 POHC Limit(A): 0.304

Highest parameter values during test:

V_RMS (Volts): 219.94	Frequency(Hz): 50.00
I_Peak (Amps): 0.269	I_RMS (Amps): 0.069
I_Fund (Amps): 0.045	Crest Factor: 3.893
Power (Watts): 9.3	Power Factor: 0.615

Harm#	Harms(avg)	100%Limit	%of Limit	Harms(max)	150%Limit	%of Limit	Status
2	0.001	1.080	0.0	0.001	1.620	0.06	Pass
3	0.013	2.300	0.6	0.014	3.450	0.40	Pass
4	0.001	0.430	0.0	0.001	0.645	0.10	Pass
5	0.037	1.140	3.3	0.038	1.710	2.21	Pass
6	0.000	0.300	0.0	0.000	0.450	0.07	Pass
7	0.015	0.770	2.0	0.018	1.155	1.53	Pass
8	0.000	0.230	0.0	0.000	0.345	0.04	Pass
9	0.017	0.400	4.2	0.018	0.600	2.95	Pass
10	0.000	0.184	0.0	0.000	0.276	0.09	Pass
11	0.013	0.330	3.8	0.014	0.495	2.86	Pass
12	0.000	0.153	0.0	0.000	0.230	0.08	Pass
13	0.010	0.210	4.6	0.010	0.315	3.28	Pass
14	0.000	0.131	0.0	0.000	0.197	0.08	Pass
15	0.010	0.150	6.5	0.011	0.225	5.00	Pass
16	0.000	0.115	0.0	0.000	0.173	0.05	Pass
17	0.006	0.132	4.9	0.007	0.199	3.67	Pass
18	0.000	0.102	0.0	0.000	0.153	0.11	Pass
19	0.008	0.118	7.0	0.009	0.178	5.21	Pass
20	0.000	0.092	0.0	0.000	0.138	0.06	Pass
21	0.004	0.107	0.0	0.005	0.161	3.09	Pass
22	0.000	0.084	0.0	0.000	0.125	0.09	Pass
23	0.007	0.098	7.0	0.008	0.147	5.22	Pass
24	0.000	0.077	0.0	0.000	0.115	0.08	Pass
25	0.003	0.090	0.0	0.004	0.135	2.88	Pass
26	0.000	0.071	0.0	0.000	0.106	0.09	Pass
27	0.006	0.083	7.1	0.006	0.125	5.16	Pass
28	0.000	0.066	0.0	0.000	0.099	0.13	Pass
29	0.002	0.078	0.0	0.003	0.116	2.52	Pass
30	0.000	0.061	0.0	0.000	0.092	0.15	Pass
31	0.005	0.073	7.2	0.005	0.109	5.03	Pass
32	0.000	0.058	0.0	0.000	0.086	0.16	Pass
33	0.002	0.068	0.0	0.002	0.102	2.29	Pass
34	0.000	0.054	0.0	0.000	0.081	0.11	Pass
35	0.005	0.064	0.0	0.005	0.096	5.03	Pass
36	0.000	0.051	0.0	0.000	0.077	0.10	Pass
37	0.001	0.061	0.0	0.002	0.091	2.11	Pass
38	0.000	0.048	0.0	0.000	0.073	0.14	Pass
39	0.004	0.058	0.0	0.004	0.087	4.88	Pass
40	0.000	0.046	0.0	0.000	0.069	0.12	Pass

Voltage Source Verification Data (Run time)

Test category: Class-C per Ed. 3.0 (2014) (European limits)
 Test Margin: 100 Tested by: LH
 Start time: 10:41:24 End time: 10:51:45
 Test duration (min): 10 Data file name: H-000477.cts_data
 Customer: Customer

Test Result: Pass Source qualification: Normal

Highest parameter values during test:

Voltage (Vrms):	219.94	Frequency(Hz):	50.00
I_Peak (Amps):	0.269	I_RMS (Amps):	0.069
I_Fund (Amps):	0.045	Crest Factor:	3.893
Power (Watts):	9.3	Power Factor:	0.615

Harm#	Harmonics V-rms	Limit V-rms	% of Limit	Status
2	0.063	0.440	14.40	OK
3	0.472	1.979	23.87	OK
4	0.059	0.440	13.35	OK
5	0.047	0.880	5.38	OK
6	0.019	0.440	4.42	OK
7	0.036	0.660	5.41	OK
8	0.013	0.440	2.98	OK
9	0.029	0.440	6.51	OK
10	0.013	0.440	2.92	OK
11	0.016	0.220	7.44	OK
12	0.010	0.220	4.77	OK
13	0.016	0.220	7.36	OK
14	0.006	0.220	2.64	OK
15	0.018	0.220	8.04	OK
16	0.010	0.220	4.41	OK
17	0.011	0.220	5.09	OK
18	0.010	0.220	4.34	OK
19	0.014	0.220	6.45	OK
20	0.009	0.220	4.28	OK
21	0.010	0.220	4.39	OK
22	0.003	0.220	1.15	OK
23	0.012	0.220	5.40	OK
24	0.003	0.220	1.43	OK
25	0.008	0.220	3.74	OK
26	0.003	0.220	1.57	OK
27	0.008	0.220	3.67	OK
28	0.003	0.220	1.49	OK
29	0.006	0.220	2.91	OK
30	0.003	0.220	1.32	OK
31	0.008	0.220	3.85	OK
32	0.003	0.220	1.34	OK
33	0.006	0.220	2.94	OK
34	0.003	0.220	1.29	OK
35	0.009	0.220	4.31	OK
36	0.002	0.220	1.02	OK
37	0.005	0.220	2.42	OK
38	0.002	0.220	0.98	OK
39	0.007	0.220	3.19	OK
40	0.005	0.220	2.20	OK

8. Voltage Fluctuation and Flicker test

8.1. Test Standard and Limit

8.1.1. Test Standard

EN 61000-3-3: 2013/A1:2019

8.1.2. Limit

Voltage Fluctuation and Flicker Test Limit

Test Items	Limits
Pst	1.0
dc	3.3%
dmax	4.0%
dt	Not exceed 3.3% for 500ms

8.2. Test Setup

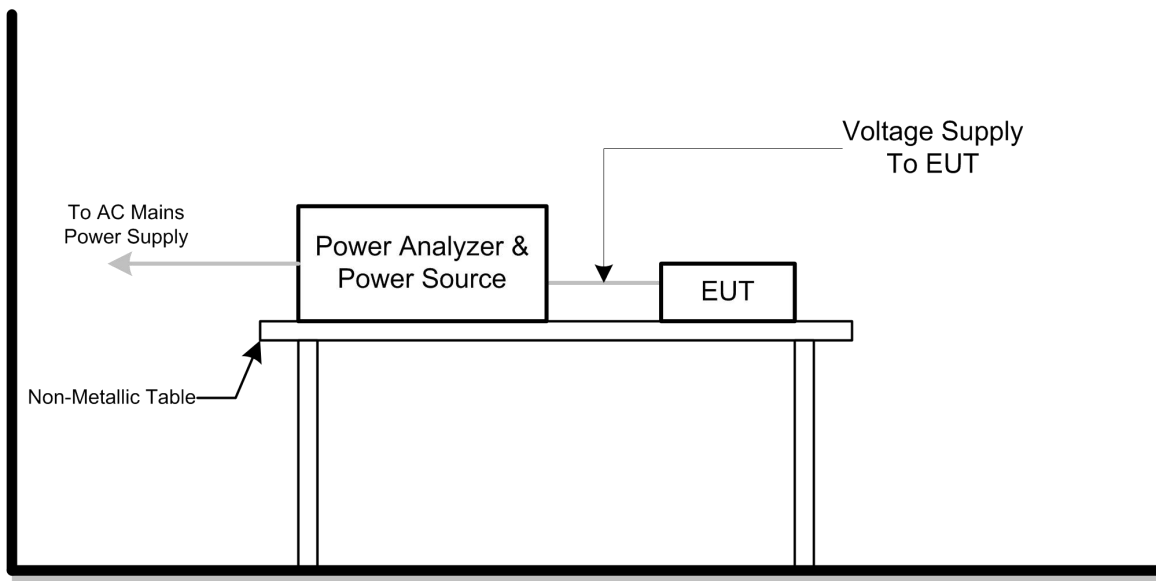

8.3. Test Procedure

8.3.1. Harmonic Current Test:

Test was performed according to the procedures specified in Clause 5.0 of IEC555-2 and/or Sub-clause 6.2 of IEC/EN 61000-3-2 depend on which standard adopted for compliance measurement.

8.3.2. Fluctuation and Flickers Test:

Tests was performed according to the Test Conditions/Assessment of Voltage

Fluctuations specified in Clause 5.0/6.0 of IEC555-3 and/or Clause 6.0/4.0 of IEC/EN 61000-3-3 depend on which standard adopted for compliance measurement.

8.3.3. All types of harmonic current and/or voltage fluctuation in this report are assessed by direct measurement using flicker-meter.

8.3.4. For the actual test configuration, please refer to the related Item –Block Diagram of system tested (please refer to 1.3).

8.4. Test Condition

Temperature	:	25 °C
Relative Humidity	:	48 %
Pressure	:	1010 hPa
Test Power	:	AC 230V/50Hz

8.5. Test Data

Please refer to the following page.

Flicker Test Summary per EN/IEC61000-3-3 (Run time)

Test category: All parameters (European limits)
 Test Margin: 100 Tested by: LH
 Start time: 15:18:45 End time: 15:29:07
 Test duration (min): 10 Data file name: F-000473.cts_data
 Customer: Customer

Test Result: Pass Status: Test Completed

Pst and limit line

European Limits

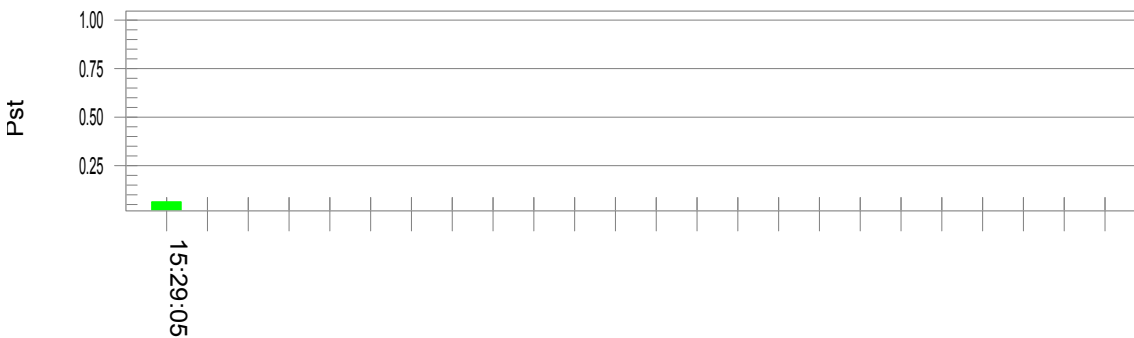

Plt and limit line

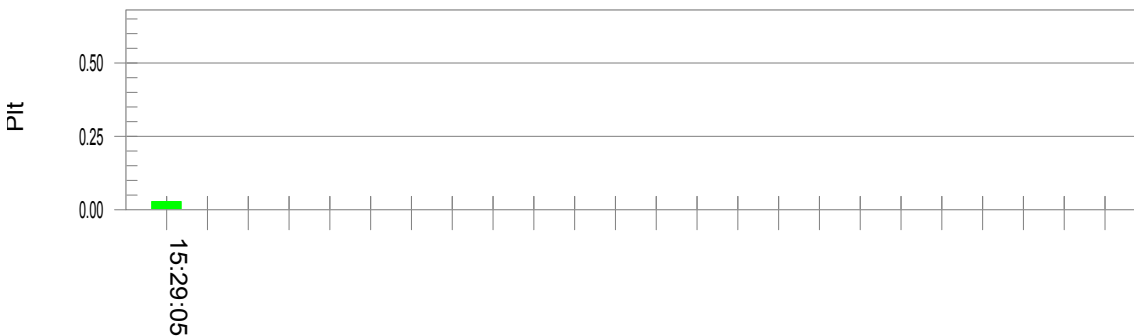

Parameter values recorded during the test:

Vrms at the end of test (Volt):	229.86			
Highest dt (%):	0.00	Test limit (%):	3.30	Pass
Time(mS) > dt:	0.0	Test limit (mS):	500.0	Pass
Highest dc (%):	0.00	Test limit (%):	3.30	Pass
Highest dmax (%):	0.00	Test limit (%):	4.00	Pass
Highest Pst (10 min. period):	0.064	Test limit:	1.000	Pass
Highest Plt (2 hr. period):	0.028	Test limit:	0.650	Pass

9. Electrostatic Discharge Immunity Test

9.1. Test Requirements

9.1.1. Test Standard

EN 61547: 2009 (EN 61000-4-2: 2009)

9.1.2. Test Level

Level	Test Voltage Contact Discharge (kV)	Test Voltage Air Discharge (kV)
1	±2	±2
2	±4	±4
3	±6	±8
4	±8	±15
X	Special	Special

9.1.3. Performance criterion: **B**

9.2. Test Setup

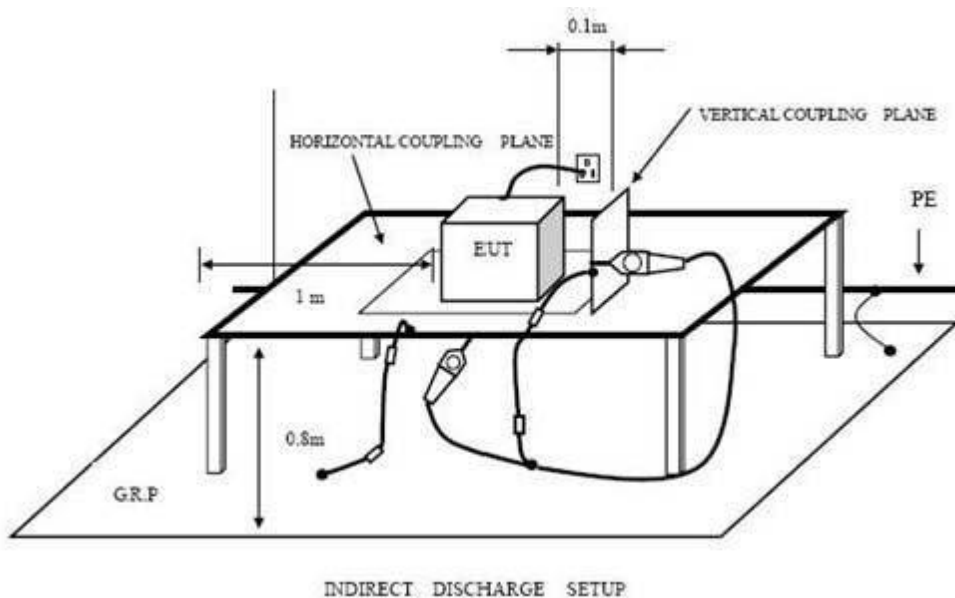

9.3. Test Procedure

9.3.1. Air Discharge:

This test is done on a non-conductive surface. The round discharge tip of the discharge electrode shall be approached as fast as possible to touch the EUT. After each discharge, the discharge electrode shall be removed from the EUT. The generator is then

re-triggered for a new single discharge and repeated 10 times for each pre-selected test point. This procedure shall be repeated until all the air discharge completed.

9.3.2. Contact Discharge:

All the procedure shall be same as air discharge. Except that the tip of the discharge electrode shall touch the EUT before the discharge switch is operated.

9.3.3. Indirect discharge for horizontal coupling plane

At least 10 single discharges (in the most sensitive polarity) shall be applied at the front edge of each HCP opposite the center point of each unit (if applicable) of the EUT and 0.1m from the front of the EUT. The long axis of the discharge electrode shall be in the plane of the HCP and perpendicular to its front edge during the discharge.

9.3.4. Indirect discharge for vertical coupling plane

At least 10 single discharges (in the most sensitive polarity) shall be applied to the center of one vertical edge of the coupling plane. The coupling plane, of dimensions 0.5m X 0.5m, is placed parallel to, and positioned at a distance of 0.1m from the EUT. Discharges shall be applied to the coupling plane, with this plane in sufficient different positions that the four faces of the EUT are completely illuminated.

9.4. Test Data

Please refer to the following page.

Electrostatic Discharge Test Result

EUT	: <u>Ceiling lamp</u>	M/N	: <u>RY0228</u>
Temperature	: <u>22°C</u>	Humidity	: <u>50%</u>
Power supply	: <u>AC 230V/50Hz</u>	Test Mode	: <u>Normal</u>
Criterion: B			
Air Discharge: $\pm 8\text{kV}$ Contact Discharge: $\pm 4\text{kV}$			
For each point positive 10 times and negative 10 times discharge.			
Location	Kind A-Air Discharge C-Contact Discharge		Result
Nonconductive Enclosure	A		PASS
Slot of EUT	A		PASS
HCP	C		PASS
VCP of front	C		PASS
VCP of rear	C		PASS
VCP of left	C		PASS
VCP of right	C		PASS
Remark:			

10. Radiated Electromagnetic Field Immunity Test

10.1. Test Requirements

10.1.1. Test Standard

EN 61547: 2009 (EN IEC 61000-4-3:2020)

10.1.2. Test Level

Level	Field Strength V/m
1	1
2	3
3	10
X	Special

10.1.3. Performance criterion: **A**

10.2. Test Setup

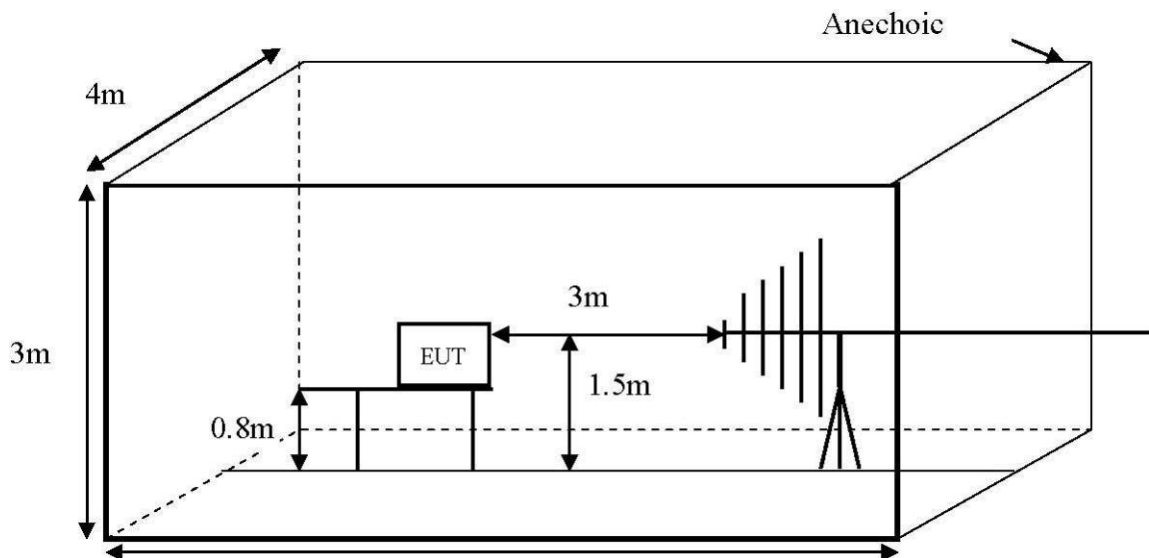

10.3. Test Procedure

The EUT are placed on a table, which is 0.8 meter high above the ground. The EUT is set 3 meters away from the transmitting antenna, which is mounted on an antenna tower. Both horizontal and vertical polarization of the antenna is set on test. Each of the four sides of the EUT must be faced this transmitting antenna and measured individually.

In order to judge the EUT performance, a camera is used to monitor its screen.

All the scanning conditions are as following:

Condition of Test	Remark
Fielded strength	3V/m (Severity Level 2)
Radiated signal	Modulated
Scanning frequency	80-1000MHz
Sweep time of radiated	0.0015 Decade/s
Dwell time	1 Sec.

10.4. Test Data

Please refer to the following page.

RF Field Strength Susceptibility Test Results

EUT	: <u>Ceiling lamp</u>	M/N	: <u>RY0228</u>	
Temperature	: <u>22°C</u>	Humidity	: <u>50%</u>	
Power supply	: <u>AC 230V/50Hz</u>	Test Mode	: <u>Normal</u>	
Criterion: A				
Modulation: Unmodulated				
Pulse: AM 1KHz 80%				
	Frequency Rang 1		Frequency Rang 2	
	80~1000MHz			
	Horizontal	Vertical	Horizontal	Vertical
Front	PASS	PASS	/	/
Right	PASS	PASS	/	/
Rear	PASS	PASS	/	/
Left	PASS	PASS	/	/
Remark:				

11. Electrical Fast Transient/Burst Test

11.1. Test Requirements

11.1.1. Test Standard

EN 61547: 2009 (EN 61000-4-4: 2012)

11.1.2. Level

Open Circuit Output Test Voltage $\pm 10\%$		
Level	On Switching Adapter Lines	On I/O (Input/Output) Signal data and control lines
1	0.5 kV	0.25 kV
2	1 kV	0.5 kV
3	2 kV	1 kV
4	4 kV	2 kV
X	Special	Special

11.1.3. Performance criterion: **B**

11.2. Test Setup

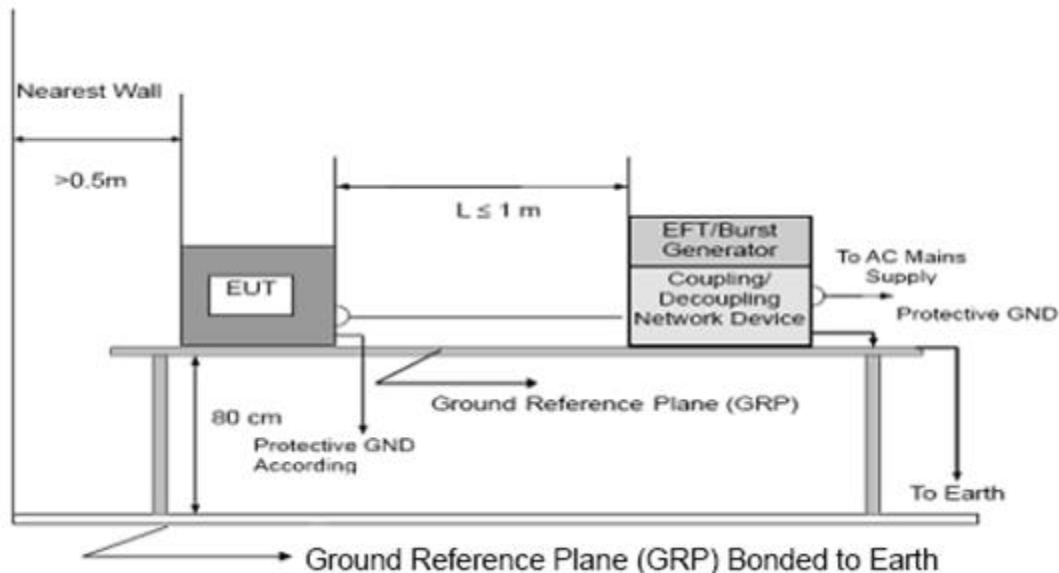

11.3. Test Procedure

11.3.1. For input and output AC power ports:

The EUT is connected to the power mains by using a coupling device which couples the

EFT interference signal to AC power lines. Both polarities of the test voltage should be applied during compliance test and the duration of the test is 1minute.

11.3.2. For signal lines and control lines ports:

A coupling clamp is use to couple the EFT interference signal to the signal and control lines. Both polarities of the test voltage should be applied during compliance test and the duration of the test is 1 minute.

11.3.3. For DC input and DC output power ports:

The EUT is connected to the power mains by using a coupling device which couples the EFT interference signal to AC power lines. Both polarities of the test voltage should be applied during compliance test and the duration of the test is 1 minute.

11.4. Test Data

Please refer to the following page.

Electrical Fast Transient/Burst Test Results

EUT : <u>Ceiling lamp</u>	M/N : <u>RY0228</u>		
Temperature : <u>22°C</u>	Humidity : <u>50%</u>		
Power supply : <u>AC 230V/50Hz</u>	Test Mode : <u>Normal</u>		
Criterion: B			
Line : <input checked="" type="checkbox"/> AC Mains Coupling : <input checked="" type="checkbox"/> Direct			
Line : <input type="checkbox"/> Signal <input type="checkbox"/> I/O Cable Coupling : <input type="checkbox"/> Capacitive			
Line	Voltage(kV)	Result(+)	Result(-)
L	1	PASS	PASS
N	1	PASS	PASS
L-N	1	PASS	PASS
PE	/	/	/
L-PE	/	/	/
N-PE	/	/	/
L-N-PE	/	/	/

12. Surge Immunity Test

12.1. Test Requirements

12.1.1. Test Standard

EN 61547: 2009 (EN 61000-4-5: 2014/A1:2017)

12.1.2. Level

Characteristics	Test levels		
	Device		
	Self-ballasted lamps and semi-luminaires	Luminaires and independent auxiliaries	
		Input power	
		≤25W	>25W
Wave-shape data	1,2/50	1,2/50	1,2/50
Test level: line to line	0,5kV	0,5kV	1,0kV
line to ground	1,0kV	1,0kV	2,0kV

12.1.3. Performance criterion: C

12.2. Test Setup

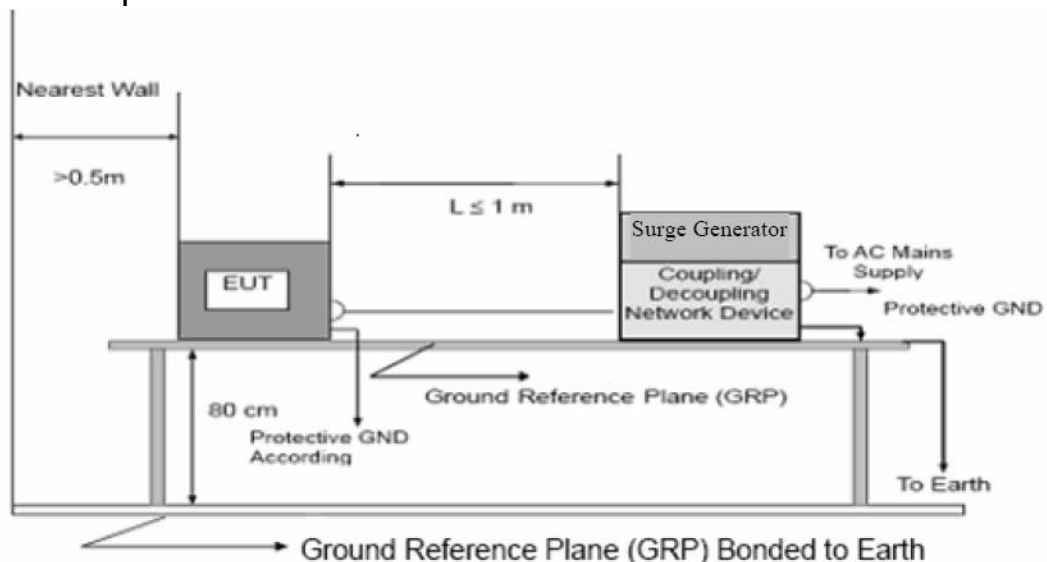

12.3. Test Procedure

12.3.1. Set up the EUT and test generator.

12.3.2. For line to line coupling mode, provide a 1.0 KV 1.2/50us voltage surge

12.3.3. (at open-circuit condition) and 8/20us current surge to EUT selected points.

12.3.4. At least 5 positive and 5 negative (polarity) tests with a maximum 1/min repetition rate are conducted during test.

12.3.5. Different phase angles are done individually.

12.3.6. Record the EUT operating situation during compliance test and decide the EUT immunity criterion for above each test.

12.4. Test Data

Please refer to the following page.

Surge Immunity Test Results

EUT	: <u>Ceiling lamp</u>	M/N	: <u>RY0228</u>	
Temperature	: <u>22°C</u>	Humidity	: <u>50%</u>	
Power supply	: <u>AC 230V/50Hz</u>	Test Mode	: <u>Normal</u>	
Criterion: C				
Injected Line	Voltage(kV)	Phase	Result	
			(+)	(-)
L-N	0.5	0°	PASS	PASS
		90°	PASS	PASS
		180°	PASS	PASS
		270°	PASS	PASS
L-PE	1.0	/	/	/
		/	/	/
		/	/	/
		/	/	/
N-PE	1.0	/	/	/
		/	/	/
		/	/	/
		/	/	/
L-N-PE	1.0	/	/	/
		/	/	/
		/	/	/
		/	/	/

13. Conducted Immunity Test

13.1. Test Requirements

13.1.1. Test Standard

EN 61547: 2009 (EN 61000-4-6: 2014)

13.1.2. Level

Level	Voltage Level (e.m.f.) V
1	1
2	3
3	10
X	Special

13.1.3. Performance criterion: **A**

13.2. Test Setup

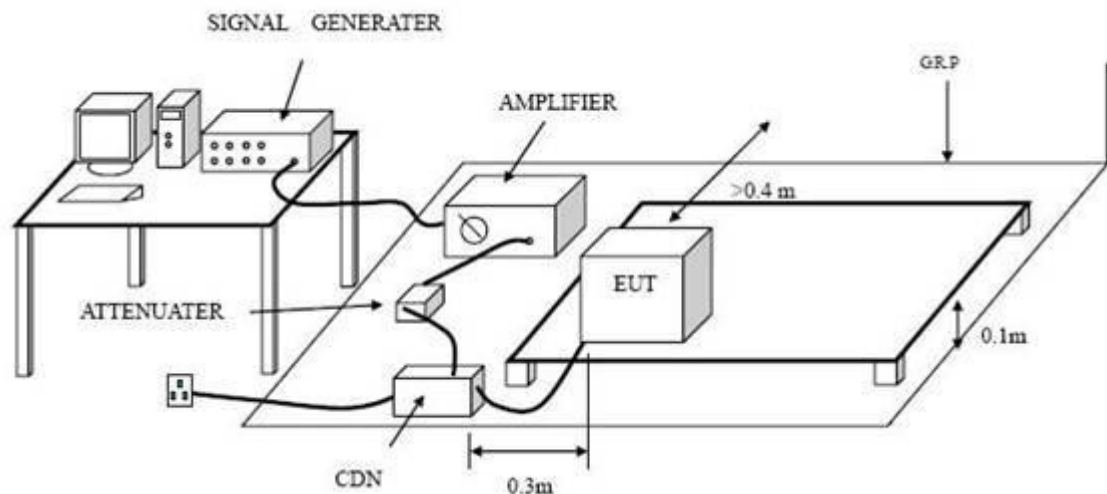

13.3. Test Procedure

13.3.1. Set up the EUT, CDN and test generators.

13.3.2. Let the EUT work in test mode and test it.

13.3.3. The EUT are placed on an insulating support 0.1m high above a ground reference plane. CDN (coupling and decoupling device) is placed on the ground plane about 0.3m from EUT. Cables between CDN and EUT are as short as possible, and their height above the ground reference plane shall be between 30 and 50 mm (where possible).

13.3.4. The disturbance signal description below is injected to EUT through CDN.

- 13.3.5. The EUT operates within its operational mode(s) under intended climatic conditions after power on.
- 13.3.6. The frequency range is swept from 0.150MHz to 80MHz using 3V signal level, and with the disturbance signal 80% amplitude modulated with a 1KHz sine wave.
- 13.3.7. The rate of sweep shall not exceed 1.5×10^{-3} decades/s. Where the frequency is swept incrementally, the step size shall not exceed 1% of the start and thereafter 1% of the preceding frequency value.
- 13.3.8. Recording the EUT operating situation during compliance testing and decide the EUT immunity criterion.

13.4. Test Data

Please refer to the following page.

Injected Currents Susceptibility Test Results

EUT : <u>Ceiling lamp</u>	M/N : <u>RY0228</u>		
Temperature : <u>22°C</u>	Humidity : <u>50%</u>		
Power supply : <u>AC 230V/50Hz</u>	Test Mode : <u>Normal</u>		
Criterion: A			
Frequency Range (MHz)	Injected Position	Voltage Level (e.m.f.)	Result
0.15 ~ 80	AC Mains	3V(rms), Unmodulated	PASS
0.15 ~ 80	DC Mains	3V(rms), Unmodulated	/
0.15 ~ 80	Signal Line	3V(rms), Unmodulated	/

14. Power frequency Magnetic Field Immunity Test

14.1. Test Requirements

14.1.1. Test Standard

EN 61547: 2009 (EN61000-4-8: 2010)

14.1.2. Level

Level	Field Strength A/m
1	1
2	3
3	10
4	30
5	100
X	Special

14.1.3. Performance criterion: A

14.2. Test Setup

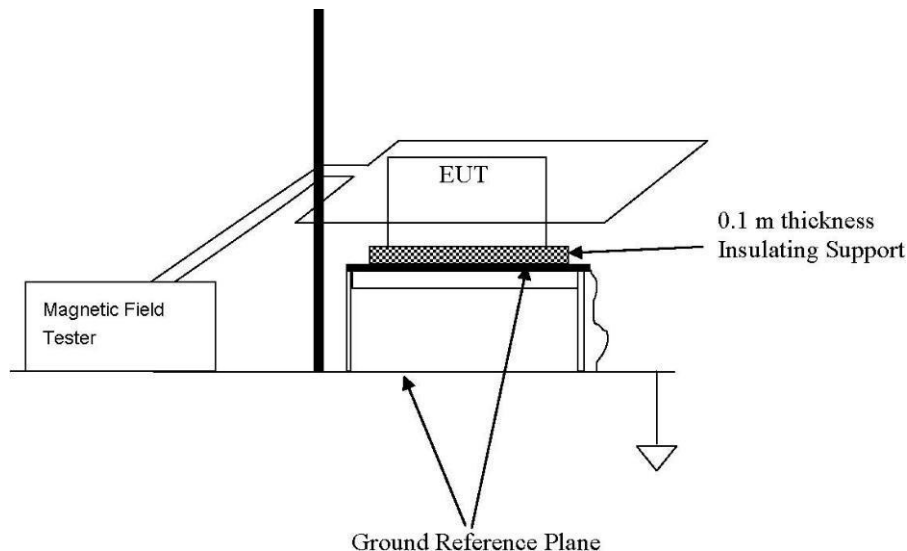

14.3. Test Procedure

The EUT is placed in the middle of a induction coil (1*1m), under which is a 1*1*0.1m (high) table, this small table is also placed on a larger table, 0.8 m above the ground. The X, Y and Z polarization of the induction coil is set on test, so that each side of the EUT is affected by the magnetic field. Also can reach the same aim by change the position of the EUT.

14.4. Test Data

Magnetic Field Immunity Test Results

EUT : <u>Ceiling lamp</u>	M/N : <u>RY0228</u>		
Temperature : <u>22°C</u>	Humidity : <u>50%</u>		
Power supply : <u>AC 230V/50Hz</u>	Test Mode : <u>ON</u>		
Criterion: A			
Test Level	Testing Duration	Coil Orientation	Result
3A/m	5 mins	X	PASS
3A/m	5 mins	Y	PASS
3A/m	5 mins	Z	PASS

15. Voltage Dips and Interruptions Immunity Test

15.1. Test Requirements

15.1.1. Test Standard

EN 61547: 2009 (EN IEC 61000-4-11:2020)

15.1.2. Level

Test Level for Voltage Dips and Interruptions

Test Level %U _T	Voltage dip and short interruptions %U _T	Duration (in period)
0	100	0.5
70	30	10

15.1.3. Performance criterion: **B&C**

15.2. Test Setup

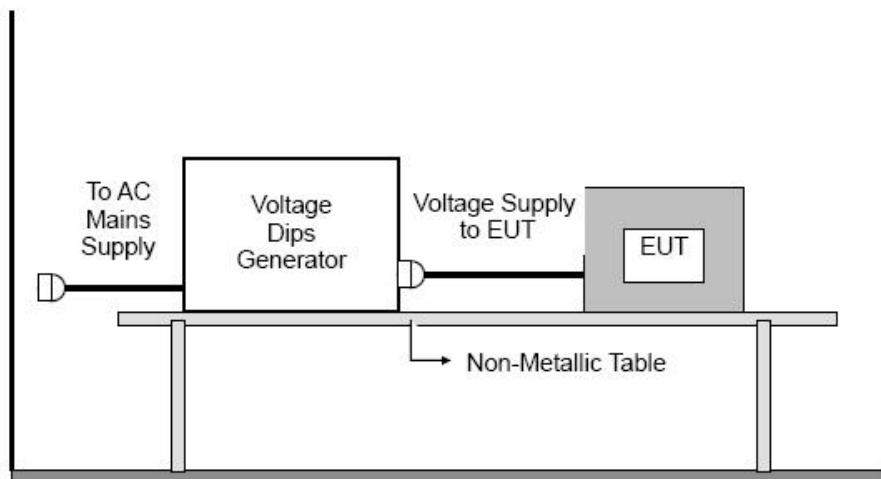

15.3. Test Procedure

Set up the EUT and test generator as shown above. The EUT is tested for each selected combination of test level and duration with a sequence of three dips/interruptions with intervals of 10s minimum.

15.4. Test Data

Voltage Dips and Interruptions Test Results

EUT : <u>Ceiling lamp</u>	M/N : <u>RY0228</u>			
Temperature : <u>22°C</u>	Humidity : <u>50%</u>			
Power supply : <u>AC 230V/50Hz</u>	Test Mode : <u>ON</u>			
Criterion: B&C				
Test Level % U _T	Voltage Dips & Short Interruptions % U _T	Duration (in period)	Phase Angle	Result
0	100	0.5P	0°~360°	PASS
70	30	10P	0°~360°	PASS
Remark: U _T is the rated voltage for the equipment.				

16. Photographs - Constructional Details

Photo 1 Appearance of EUT

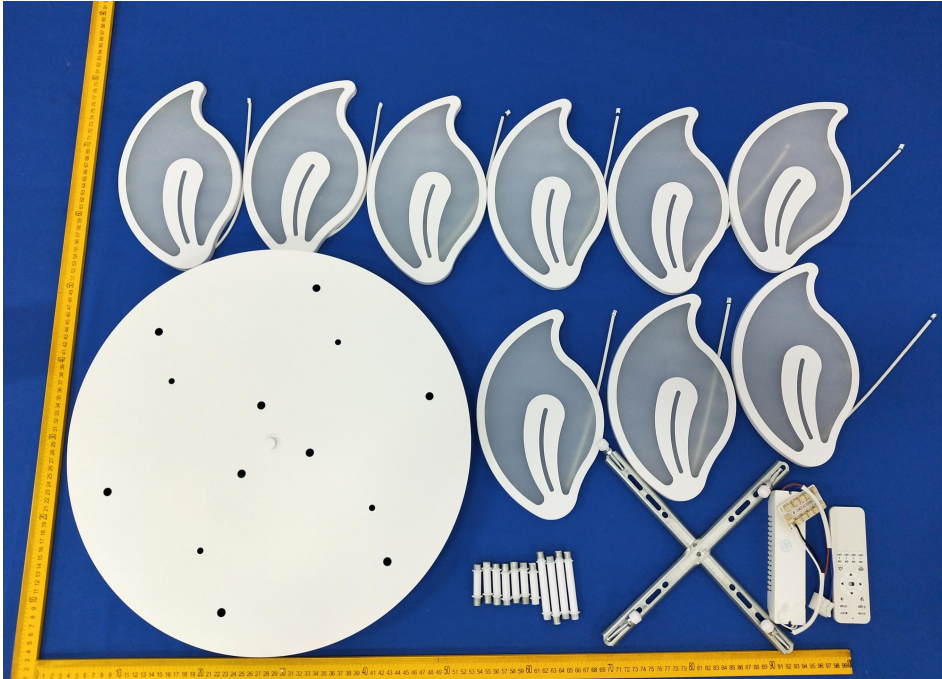

Photo 2 Appearance of EUT



Photo 3 inside of EUT

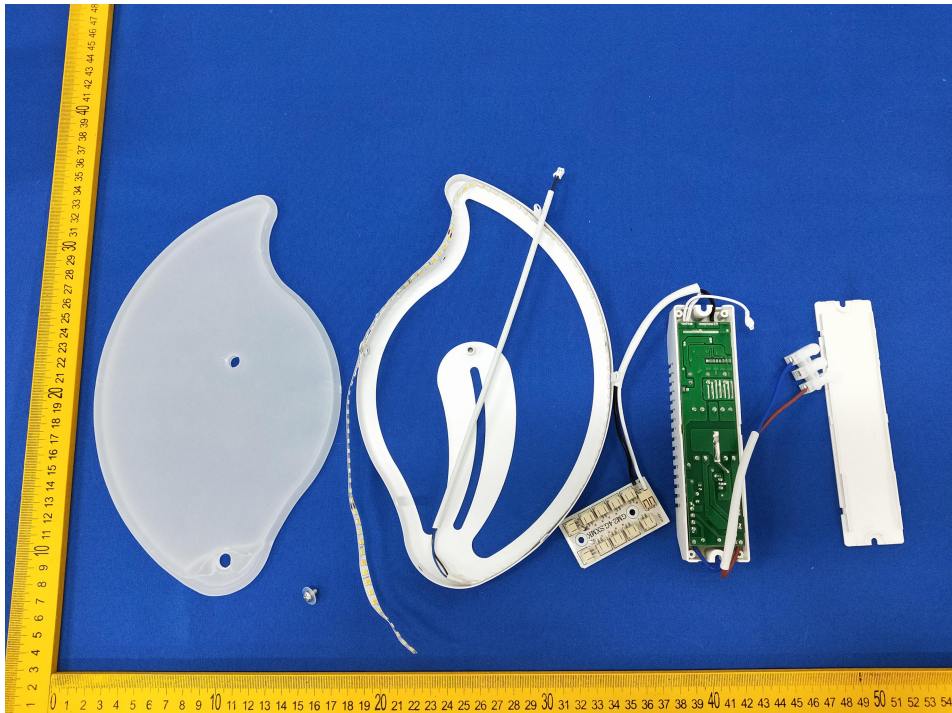

Photo 4 Appearance of PCB

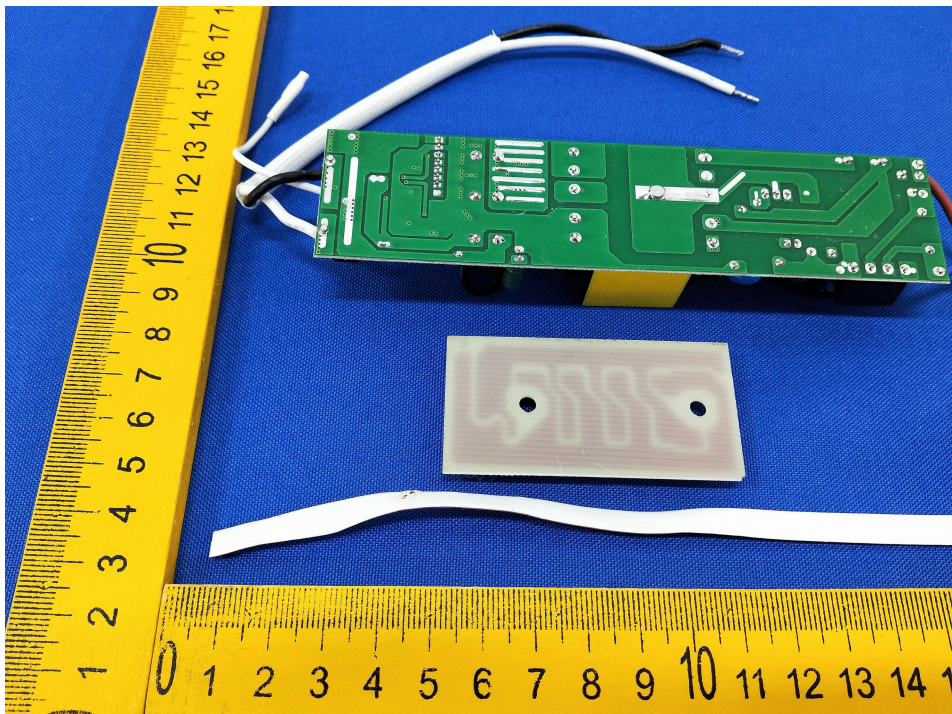
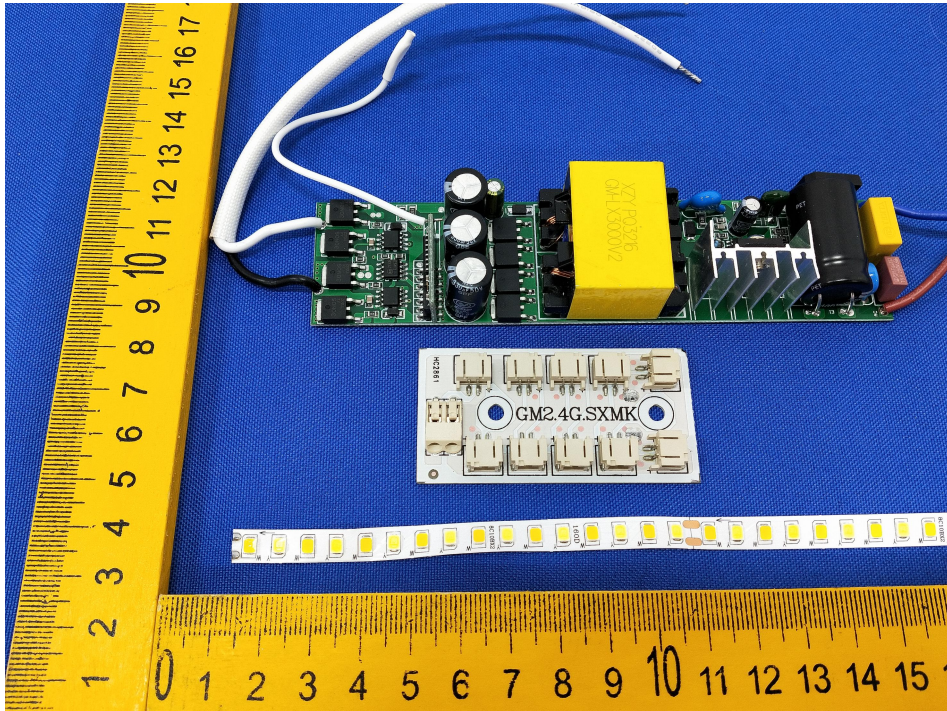

Photo 5 Appearance of PCB



END OF REPORT