

# RICOH

SLR Digital Camera

# PENTAX *K-S1*

Operating Manual

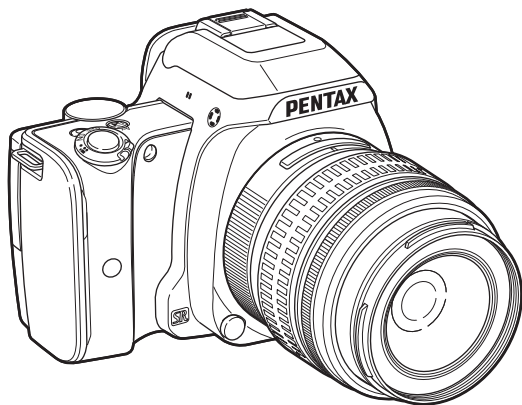

Introduction 1

Getting Started 2

Shooting 3

Playback 4

Settings 5

Appendix 6

To ensure the best performance from your camera, please read the Operating Manual before using the camera.

## Checking the Contents of the Package



Hot shoe cover Fk  
(Installed on camera)



Eyecup FR  
(Installed on camera)

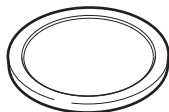

Body mount cover  
(Installed on camera)

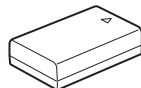

Rechargeable Lithium-ion  
Battery D-LI109

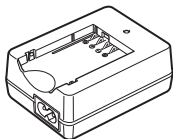

Battery charger  
D-BC109



AC plug cord

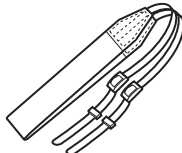

Strap  
O-ST132

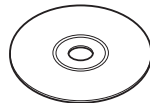

Software (CD-ROM)  
S-SW151



Start Guide

### Lenses you can use

Lenses that can be used with this camera are DA, DA L, D FA and FA J lenses and lenses that have an **A** (Auto) position on the aperture ring. To use any other lens or accessory, see p.90.

**Introducing the K-S1**

**1**

**Getting Started**

**2**

**Taking Pictures**

**3**

**Playback Functions**

**4**

**Changing the Settings**

**5**

**Appendix**

**6**

# How to Use This Manual

## 1

### Introducing the PENTAX K-S1 ..... p.7

Gives you an overview of the K-S1.  
Read this and get to know your K-S1!

- Names and Functions of the Working Parts** ..... p.7
- How to Change Function Settings** ..... p.16
- Menu List** ..... p.19

## 2

### Getting Started..... p.27

Explains how to get your K-S1 ready for shooting as well as basic operations.

- Attaching the Strap** ..... p.27
- Attaching a Lens** ..... p.27
- Using the Battery and Charger** ..... p.28
- Inserting a Memory Card** ..... p.31
- Initial Settings** ..... p.32
- Basic Shooting Operation** ..... p.35
- Reviewing Images** ..... p.37

## 3

### Taking Pictures ..... p.38

Once you've confirmed that the camera works properly, try out the camera and take lots of pictures!

- Configuring the Capture Settings** ..... p.38
- Taking Still Pictures** ..... p.39
- Recording Movies** ..... p.44
- Setting the Exposure** ..... p.46
- Using the Built-in Flash** ..... p.47
- Setting the Focus Method** ..... p.49
- Setting the Drive Mode** ..... p.53
- Setting the White Balance** ..... p.56
- Controlling the Image Finishing Tone** ..... p.58
- Correcting Images** ..... p.61

## 4

### **Playback Functions ..... p.64**

Explains various operations for playing back and editing images.

- Playback Mode Palette Items ..... p.64**
- Changing the Playback Method ..... p.65**
- Connecting the Camera to a Computer ..... p.69**
- Editing and Processing Images ..... p.70**

## 5

### **Changing the Settings..... p.77**

Explains how to change other settings.

- Camera Settings ..... p.77**
- File Management Settings ..... p.81**

## 6

### **Appendix..... p.88**

Provides various resources.

- Restrictions on Each Capture Mode ..... p.88**
- Functions Available with Various Lenses ..... p.90**
- Functions when Using an External Flash ..... p.93**
- Using the GPS Unit ..... p.94**
- Troubleshooting ..... p.95**
- Main Specifications ..... p.98**
- Index ..... p.105**
- For Using Your Camera Safely ..... p.110**
- Care to be Taken During Handling ..... p.112**
- WARRANTY POLICY ..... p.115**

There is a possibility that the illustrations and the display screen of the monitor in this manual are different from the actual ones.

# Contents

<b>How to Use This Manual .....</b>	<b>2</b>
<b>Introducing the PENTAX K-S1 .....</b>	<b>7</b>
<b>Names and Functions of the Working Parts .....</b>	<b>7</b>
Operating Controls .....	8
Monitor .....	10
Viewfinder .....	15
<b>How to Change Function Settings .....</b>	<b>16</b>
Using the Direct Keys .....	16
Using the Control Panel .....	17
Using the Menus .....	18
<b>Menu List .....</b>	<b>19</b>
Rec. Mode Menus .....	19
Movie Menu .....	22
Playback Menu .....	22
Set-up Menu .....	23
Custom Setting Menus .....	25
<b>Getting Started .....</b>	<b>27</b>
<b>Attaching the Strap .....</b>	<b>27</b>
<b>Attaching a Lens .....</b>	<b>27</b>
<b>Using the Battery and Charger .....</b>	<b>28</b>
Charging the Battery .....	28
Inserting/Removing the Battery .....	29
Using the AC Adapter .....	30
<b>Inserting a Memory Card .....</b>	<b>31</b>
<b>Initial Settings .....</b>	<b>32</b>
Turning the Camera On .....	32

Setting the Display Language .....	32
Setting the Date and Time .....	33
Setting the LCD Display .....	34
Formatting a Memory Card .....	34
<b>Basic Shooting Operation .....</b>	<b>35</b>
Shooting with Live View .....	36
<b>Reviewing Images .....</b>	<b>37</b>
<b>Taking Pictures .....</b>	<b>38</b>
<b>Configuring the Capture Settings .....</b>	<b>38</b>
Image Capture Settings .....	38
Movie Capture Settings .....	38
<b>Taking Still Pictures .....</b>	<b>39</b>
Scene Modes .....	39
Effects Modes .....	41
Exposure Modes .....	42
EV Compensation .....	43
<b>Recording Movies .....</b>	<b>44</b>
Playing Back Movies .....	45
<b>Setting the Exposure .....</b>	<b>46</b>
Sensitivity .....	46
AE Metering .....	47
<b>Using the Built-in Flash .....</b>	<b>47</b>
<b>Setting the Focus Method .....</b>	<b>49</b>
Setting the AF Mode when Shooting with the Viewfinder .....	49
Setting the AF Mode during Live View .....	51
AF Fine Adjustment .....	53

<b>Setting the Drive Mode</b> .....	<b>53</b>	<b>Changing the Settings</b> .....	<b>77</b>
Continuous Shooting .....	54	<b>Camera Settings</b> .....	<b>77</b>
Self-timer .....	54	Customizing the Button/E-dial Functions .....	77
Remote Control .....	55	Displaying the Local Date and Time of the Specified City .....	80
Exposure Bracketing .....	55	Selecting Settings to Save in the Camera .....	81
<b>Setting the White Balance</b> .....	<b>56</b>	<b>File Management Settings</b> .....	<b>81</b>
Adjusting the White Balance Manually .....	57	Protecting Images from Deletion (Protect) .....	81
Adjusting the White Balance with Color Temperature .....	58	Selecting the Folder/File Settings .....	82
<b>Controlling the Image Finishing Tone</b> .....	<b>58</b>	Setting the Copyright Information .....	85
Custom Image .....	58	Using a Wireless Memory Card .....	86
Digital Filter .....	60	<b>Appendix</b> .....	<b>88</b>
<b>Correcting Images</b> .....	<b>61</b>	<b>Restrictions on Each Capture Mode</b> .....	<b>88</b>
Brightness Adjustment .....	61	Restrictions on the Combinations of Special Functions .....	89
Lens Correction .....	62	<b>Functions Available with Various Lenses</b> .....	<b>90</b>
Anti-Aliasing Filter Simulator .....	63	Setting the Focal Length .....	91
<b>Playback Functions</b> .....	<b>64</b>	Using the Aperture Ring .....	92
<b>Playback Mode Palette Items</b> .....	<b>64</b>	<b>Functions when Using an External Flash</b> .....	<b>93</b>
<b>Changing the Playback Method</b> .....	<b>65</b>	<b>Using the GPS Unit</b> .....	<b>94</b>
Displaying Multiple Images .....	65	Shooting Celestial Bodies (ASTROTRACER) .....	94
Displaying Images by Folder .....	66	<b>Troubleshooting</b> .....	<b>95</b>
Displaying Images by Shooting Date .....	67	Sensor Cleaning .....	96
Playing Back Images Continuously (Slideshow) .....	67	Error Messages .....	97
Displaying Rotated Images .....	68	<b>Main Specifications</b> .....	<b>98</b>
Connecting the Camera to an AV Device .....	68	Operating Environment for USB Connection and Provided Software .....	104
<b>Connecting the Camera to a Computer</b> .....	<b>69</b>	<b>Index</b> .....	<b>105</b>
<b>Editing and Processing Images</b> .....	<b>70</b>	<b>For Using Your Camera Safely</b> .....	<b>110</b>
Changing the Image Size .....	70	<b>Care to be Taken During Handling</b> .....	<b>112</b>
Correcting Color Moiré .....	71	<b>WARRANTY POLICY</b> .....	<b>115</b>
Processing Images with Digital Filters .....	72		
Editing Movies .....	73		
RAW Development .....	75		

### Regarding copyrights

Images taken with this camera that are for anything other than personal enjoyment cannot be used without permission according to the rights as specified in the Copyright Act. Please take care, as there are cases where limitations are placed on taking pictures even for personal enjoyment during demonstrations, performances or of items on display. Images taken with the purpose of obtaining copyrights also cannot be used outside the scope of use of the copyright as laid out in the Copyright Act, and care should be taken here also.

### To users of this camera

- Do not use or store this camera in the vicinity of equipment that generates strong electromagnetic radiation or magnetic fields. Strong static charges or the magnetic fields produced by equipment such as radio transmitters could interfere with the monitor, damage the stored data, or affect the camera's internal circuitry and cause camera misoperation.
- The liquid crystal panel used for the monitor is manufactured using extremely high precision technology. Although the level of functioning pixels is 99.99% or better, you should be aware that 0.01% or fewer of the pixels may not illuminate or may illuminate when they should not. However, this has no effect on the recorded image.
- In this manual, the generic term "computer(s)" refers to either a Windows PC or a Macintosh.
- In this manual, the term "battery(ies)" refers to any type of batteries used for this camera and its accessories.

### Regarding User Registration

In order to better serve you, we request that you complete the user registration, which can be found on the CD-ROM supplied with the camera or on our website. Thank you for your cooperation.





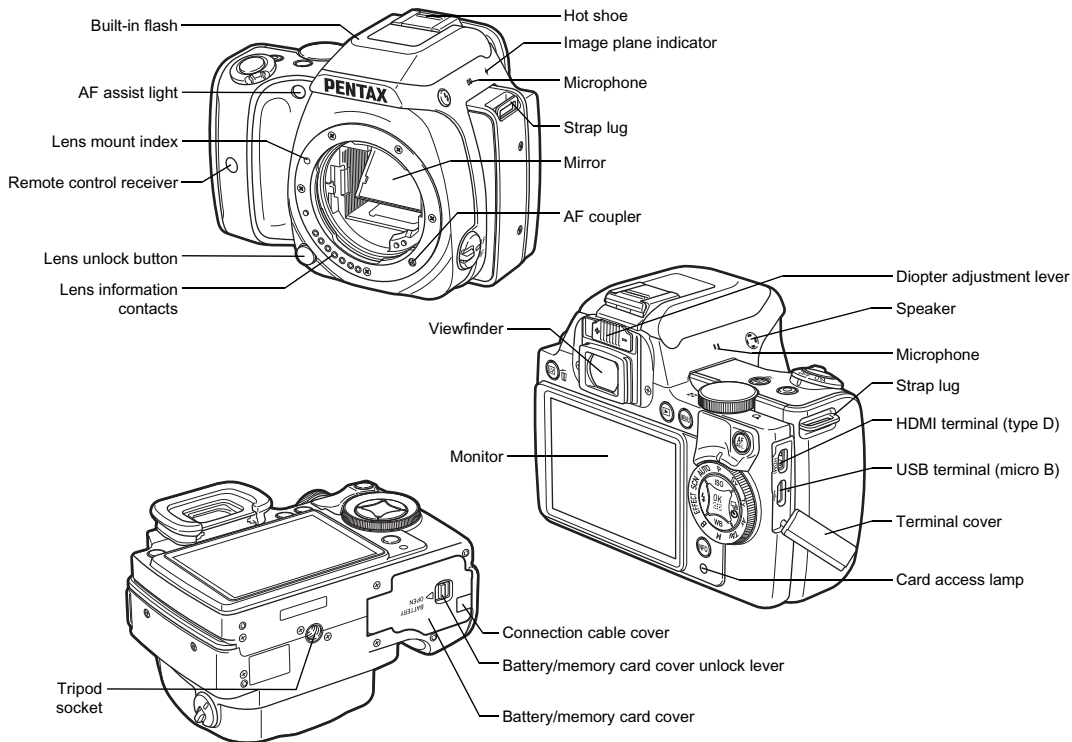



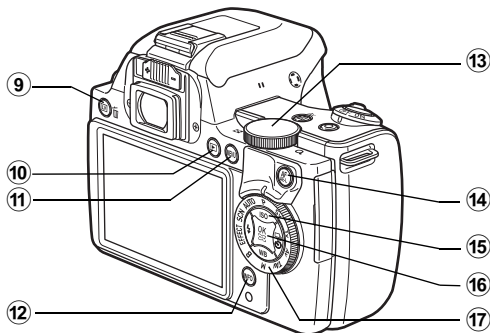
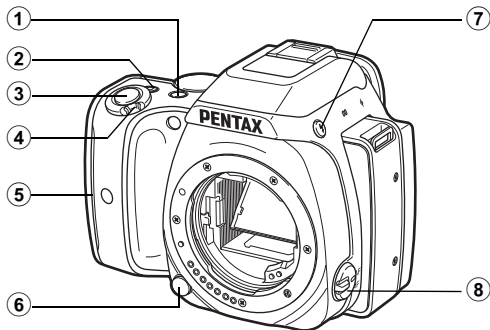

# Names and Functions of the Working Parts







## Operating Controls



- ① EV Compensation button (  /Av )**  
 Press to change the exposure compensation value. (p.43)  
 In **TAv/M** mode, use this button to switch the value to be changed between shutter speed and aperture value.  
 In playback mode, the last JPEG image taken can also be saved in RAW format. (p.37)
- ② Green button (  )**  
 Resets the value being adjusted.  
 Switches to [ISO AUTO] when adjusting the sensitivity.  
 Also, you can assign other functions to this button. (p.78)
- ③ Shutter release button (  )**  
 Press to capture images. (p.35)  
 In playback mode, press halfway to switch to capture mode.
- ④ Main switch**  
 Turns the power on/off, or switches to  (movie) mode. (p.32, p.44)  
 When the camera is turned on, it enters  (still picture) mode and the lamp lights green. When the switch is turned to , the camera enters  mode and the lamp lights red.
- ⑤ Grip lamps**  
 The five lamps light up green during Self-timer shooting or shooting with a remote control unit, or when faces are detected during Live View. (p.52, p.54)
- ⑥ Lens unlock button**  
 Press to detach the lens on the camera. (p.27)
- ⑦ Flash pop-up button (  )**  
 Press to pop up the built-in flash. (p.48)
- ⑧ Focus mode switch**  
 Turn to change the focus mode. (p.49)
- ⑨ Live View/Delete button (  )**  
 Displays the Live View image. (p.36)  
 In playback mode, press to delete images. (p.37)

- 10 Playback button (⏮)**  
Switches to playback mode. (p.37)  
Press the button again to switch to capture mode.
- 11 MENU button (MENU)**  
Displays a menu. Press this button while the menu is displayed to return to the previous screen. (p.18)
- 12 INFO button (INFO)**  
Changes the style of the display on the monitor. (p.10, p.13)
- 13 E-dial (⊙)**  
Changes the values for camera settings such as exposure. (p.42)  
You can change the menu tabs when a menu screen is displayed. (p.18)  
You can change the camera settings when the control panel is displayed. (p.17)  
In playback mode, use this to magnify an image or display multiple images at the same time. (p.37, p.65)
- 14 AF/AE Lock button (AF/AE-L)**  
Available for adjusting focus, instead of pressing **SHUTTER** halfway, and for locking the exposure value before shooting. (p.49, p.77)
- 15 Four-way controller (▲▼◀▶)**  
Displays the Sensitivity, White Balance, Flash Mode or Drive Mode setup menu. (p.16)  
When a menu or the control panel is displayed, use this to move the cursor or change the item to set.  
Press ▼ in single image display of the playback mode to display the playback mode palette. (p.64)

- 16 OK button (OK)**  
When a menu or the control panel is displayed, press this button to confirm the selected item.  
Press this button when [AF Active Area] is set to  or , or when [Contrast AF] is set to  or  to change the focusing area. (p.50, p.51)  
When the power is turned on, the lamp lights blue. When the focusing area can be changed, the lamp turns off.
- 17 Mode dial**  
Changes the capture mode. (p.35)  
When the power is turned on, the lamp lights white, and the icon of the set capture mode lights green on the dial.

### About the indicator lamps

The main switch lamp, grip lamps, mode dial lamp and **OK** lamp turn off in the following situations.

- From the time when **SHUTTER** is pressed halfway until the end of shooting
- While **AF/AE-L** is pressed
- During playback mode
- While a menu is displayed
- During Auto Power Off

You can set the lamp lighting settings in [Indicator Lamps] of the  3 menu. (p.24)

### About the four-way controller

In this manual, each button of the four-way controller is indicated as shown in the illustration on the right.

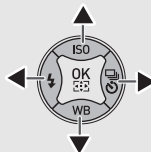

## Monitor

## Capture Mode

With this camera, you can take pictures while looking through the viewfinder or while viewing the image on the monitor. When using the viewfinder, you can take pictures while checking the status screen displayed on the monitor and looking through the viewfinder. When not using the viewfinder, you can take pictures while viewing the Live View image displayed on the monitor. The camera is in "standby mode" when it is ready to shoot, such as when the status screen or Live View image is displayed. Press **INFO** in standby mode to display the "control panel" and change settings. (p.17) You can change the type of information displayed in standby mode by pressing **INFO** while the control panel is displayed. (p.12)

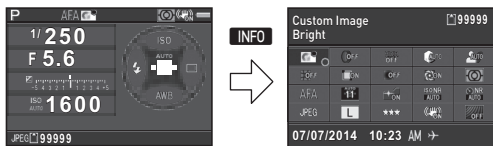

Standby mode  
(Status screen)

Control panel

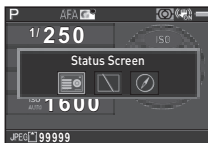

Shooting Info Display selection screen

## Status Screen

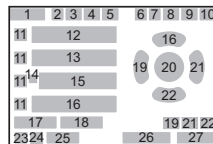

- 1 Capture mode (p.39)
- 2 AE Lock (p.44)
- 3 Focus Method (p.49)
- 4 Custom Image (p.58)
- 5 Digital Filter (p.60)/HDR Capture (p.62)
- 6 GPS positioning status (p.94)
- 7 Wireless LAN status (p.86)
- 8 AE Metering (p.47)
- 9 Shake Reduction (p.20)
- 10 Battery level
- 11 E-dial guide
- 12 Shutter speed
- 13 Aperture value
- 14 EV Compensation (p.43)/Exposure Bracketing (p.55)
- 15 EV bar scale
- 16 Sensitivity (p.46)
- 17 Flash Exposure Compensation (p.48)
- 18 White Balance fine-tuning (p.56)
- 19 Flash Mode (p.47)
- 20 Focusing area (AF point) (p.50)
- 21 Drive Mode (p.53)
- 22 White Balance (p.56)
- 23 File Format (p.38)
- 24 Memory card
- 25 Image storage capacity
- 26 ASTROTRACER maximum tracking duration (p.94)
- 27 Operation guide

## Live View

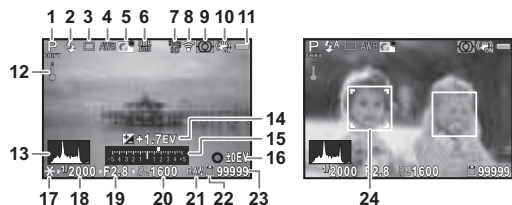

- |  |  |
|--|--|
| 1 Capture mode (p.39)                      | 13 Histogram   |
| 2 Flash Mode (p.47)                        | 14 EV Compensation (p.43)  |
| 3 Drive Mode (p.53)                        | 15 EV bar scale  |
| 4 White Balance (p.56)                     | 16 Operation guide   |
| 5 Custom Image (p.58)                      | 17 AE Lock (p.44)  |
| 6 Digital Filter (p.60)/HDR Capture (p.62) | 18 Shutter speed   |
| 7 GPS positioning status (p.94)            | 19 Aperture value  |
| 8 Wireless LAN status (p.86)               | 20 Sensitivity (p.46)  |
| 9 AE Metering (p.47)                       | 21 File Format (p.38)  |
| 10 Shake Reduction (p.20)/Movie SR (p.22)  | 22 Memory card   |
| 11 Battery level                           | 23 Image storage capacity  |
| 12 Temperature warning                     | 24 Face detection frame (when [Contrast AF] is set to [Face Detection]) (p.51) |

### Memo

- In [Live View] of the menu, you can change the settings of the items displayed on the monitor during Live View. (p.20)

## Control Panel

### 📷 mode

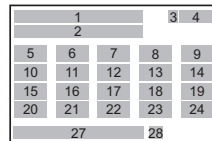
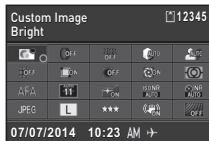

### When shooting with Live View

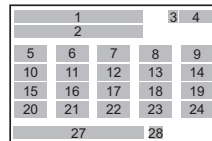
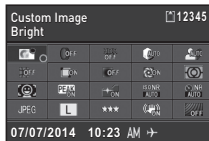

### 📷 mode

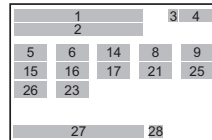
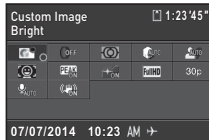





- |   |   |
|---|---|
| 1 Function name   | 6 Digital Filter (p.60)                           |
| 2 Setting   | 7 HDR Capture (p.62)                              |
| 3 Memory card   | 8 Highlight Correction (p.61)                     |
| 4 Number of recordable still pictures/Movie recordable time | 9 Shadow Correction (p.61)                        |
| 5 Custom Image (p.58)/Scene Mode (p.39)/Effects Mode (p.41) | 10 Distortion Correction (p.62)                   |
|   | 11 Lateral Chromatic Aberration Adjustment (p.62) |

- 12 Peripheral Illumination Correction (p.62)
- 13 Diffraction Correction (p.62)
- 14 AE Metering (p.47)
- 15 AF Mode (p.49)/Contrast AF (p.51)
- 16 AF Active Area (p.50)/Focus Peaking (p.52)
- 17 AF Assist Light (p.49)
- 18 High-ISO NR (p.46)
- 19 Slow Shutter Speed NR (p.43)
- 20 File Format (p.38)
- 21 JPEG Recorded Pixels (p.38)/Movie Recorded Pixels (p.38)
- 22 JPEG Quality (p.38)
- 23 Shake Reduction (p.20)/Movie SR (p.22)
- 24 AA Filter Simulator (p.63)
- 25 Framerate (p.38)
- 26 Recording Sound Level (p.45)
- 27 Current date and time
- 28 Destination (p.80)

### Memo

- The items that can be selected vary depending on the current camera setup.
- If no operations are made within 1 minute while the control panel is displayed, the camera returns to standby mode.
- You can change the display color of the status screen, control panel and menu cursor in [Display Color] of [LCD Display] in the 1 menu. (p.23)

### Shooting Info Display

You can change the type of information displayed in standby mode by pressing  while the control panel is displayed. Use   to select the type and press .

#### When shooting with the viewfinder

<b>Status Screen</b>	Displays the settings for shooting with the viewfinder. (p.10)
<b>Display Off</b>	Nothing is displayed on the monitor.
<b>Electronic Compass</b>	The current latitude, longitude, altitude, direction, Coordinated Universal Time (UTC), capture mode, and exposure value are displayed. Turn the camera off and on again to return to the status screen. Available only when the optional GPS unit is attached to the camera and is operating. (p.94)

#### When shooting with Live View

<b>Standard Information Display</b>	The Live View image and the settings for shooting with Live View are displayed. (p.11)
<b>No Information Display</b>	Certain icons, such as those for the capture mode and drive mode, are not displayed.

### Memo

- The status screen is always displayed when the camera is turned off and on again. If [Shooting Info Display] is set to [On] in [Memory] of the 4 menu, the screen selected on the Shooting Info Display selection screen appears when the camera is turned off and on again. (p.81)

## Playback Mode

The captured image and shooting information are displayed in single image display of the playback mode.

Press **INFO** to change the type of information displayed in single image display. Use **◀▶** to select the type and press **OK**.



Single image display  
(Standard Information Display)



Playback Info Display  
selection screen

<b>Standard Information Display</b>	Captured image, file format, exposure parameters, and operation guide indicators are displayed.
<b>Detailed Information Display</b>	Detailed information on how and when the image was taken is displayed. (p.14)
<b>Histogram Display</b>	Captured image and brightness histogram are displayed. (p.15) Not available during movie playback.
<b>RGB Histogram Display</b>	Captured image and RGB histogram are displayed. (p.15) Not available during movie playback.
<b>No Information Display</b>	Only the captured image is displayed.

## Memo

- The screen selected in the Playback Info Display selection screen is displayed in playback mode when the camera is turned off and on again. If [Playback Info Display] is set to [Off] in [Memory] of the **4** menu, the [Standard Information Display] always appears first when the camera is turned on. (p.81)

## Detailed Information Display

## Still pictures

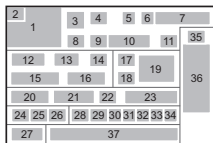

## Movies

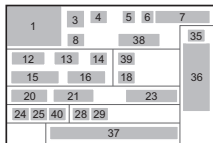
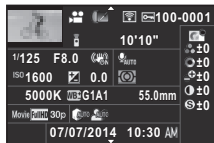

## Page 2

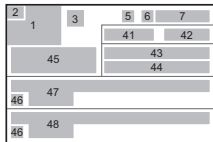
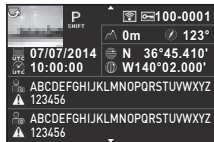

- 1 Captured image
- 2 Rotation information (p.68)
- 3 Capture mode (p.39)
- 4 Digital Filter (p.60)/HDR Capture (p.62)
- 5 Transferred via Wireless LAN (p.86)
- 6 Protect setting (p.81)
- 7 Folder number-File number (p.82)
- 8 Drive Mode (p.53)
- 9 Flash Mode (p.47)
- 10 Flash Exposure Compensation (p.48)

- 11 Color Moiré Correction (p.71)
- 12 Shutter speed
- 13 Aperture value
- 14 Shake Reduction (p.20)/Movie SR (p.22)
- 15 Sensitivity (p.46)
- 16 EV Compensation (p.43)
- 17 Focus Method (p.49)
- 18 AE Metering (p.47)
- 19 Focusing area (AF point) (p.50)
- 20 White Balance (p.56)
- 21 White Balance fine-tuning (p.56)
- 22 AA Filter Simulator (p.63)
- 23 Lens focal length
- 24 File Format (p.38)
- 25 JPEG Recorded Pixels (p.38)/Movie Recorded Pixels (p.38)
- 26 JPEG Quality (p.38)
- 27 Color Space (p.26)
- 28 Highlight Correction (p.61)
- 29 Shadow Correction (p.61)
- 30 Distortion Correction (p.62)
- 31 Lateral Chromatic Aberration Adjustment (p.62)
- 32 Peripheral Illumination Correction (p.62)
- 33 Diffraction Correction (p.62)
- 34 Color Fringe Correction (p.75)
- 35 Custom Image setting (p.58)
- 36 Custom Image parameters
- 37 Shooting date and time
- 38 Length of time of the recorded movie
- 39 Volume
- 40 Framerate (p.38)
- 41 Altitude (p.94)
- 42 Lens direction (p.94)
- 43 Latitude (p.94)
- 44 Longitude (p.94)
- 45 Universal Coordinated Time
- 46 Information tampering warning
- 47 Photographer (p.85)
- 48 Copyright Holder (p.85)



## Histogram Display/RGB Histogram Display

Use ▲▼ to switch between the Histogram Display and RGB Histogram Display.

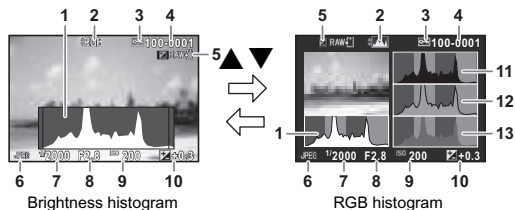

- |   |                    |
|---|--------------------|
| 1 Histogram (Brightness)                        | 7 Shutter speed    |
| 2 Switch RGB histogram/<br>Brightness histogram | 8 Aperture value   |
| 3 Protect setting                               | 9 Sensitivity      |
| 4 Folder number-File<br>number                  | 10 EV Compensation |
| 5 Save RAW Data                                 | 11 Histogram (R)   |
| 6 File Format                                   | 12 Histogram (G)   |
|   | 13 Histogram (B)   |

## Viewfinder

When shooting with the viewfinder, the following information appears in the viewfinder.

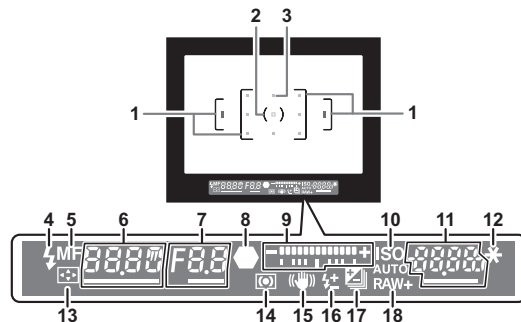

- |  |   |
|--|---|
| 1 AF frame (p.35)                                    | 12 AE Lock (p.44)   |
| 2 Spot metering frame (p.47)                         | 13 Change AF Point (p.50)                                   |
| 3 AF point (p.50)                                    | 14 AE Metering (p.47)                                       |
| 4 Flash indicator (p.47)                             | 15 Shake Reduction (p.20)                                   |
| 5 Focus Method (p.49)                                | 16 Flash Exposure<br>Compensation (p.48)                    |
| 6 Shutter speed                                      | 17 EV Compensation (p.43)/<br>Exposure Bracketing<br>(p.55) |
| 7 Aperture value                                     | 18 File Format (p.38)                                       |
| 8 Focus indicator (p.35)                             |   |
| 9 EV bar scale                                       |   |
| 10 ISO/ISO AUTO                                      |   |
| 11 Sensitivity (p.46)/Exposure<br>compensation value |   |

## Memo

- The information is displayed in the viewfinder when **SHUTTER** is pressed halfway, or during the meter operating time (default setting: 10 sec.).
- The AF point in use for autofocus appears in red (Superimpose AF Area) when **SHUTTER** is pressed halfway. You can set it to [Off] in [14 Superimpose AF Area] of the **C2** menu.
- You can adjust the diopter in the viewfinder using the diopter adjustment lever. If it is difficult to adjust the diopter adjustment lever, lift up and remove the eyecup. Adjust the lever until the AF frame in the viewfinder looks sharp and clear.

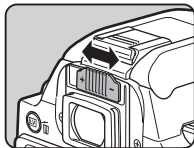

## How to Change Function Settings

The camera functions and their settings can be selected and changed by using the following ways.

<b>Direct keys</b>	Press <b>▲▼◀▶</b> in standby mode.
<b>Control panel</b>	Press <b>INFO</b> in standby mode. (indicated with the  icon in this manual)
<b>Menus</b>	Press <b>MENU</b> .

### Using the Direct Keys



<b>▲</b>	<b>Sensitivity</b>	p.46
<b>▼</b>	<b>White Balance</b>	p.56
<b>◀</b>	<b>Flash Mode</b>	p.47
<b>▶</b>	<b>Drive Mode</b>	p.53

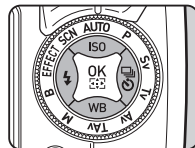

## Using the Control Panel

INFO

You can set frequently used shooting functions. Press **INFO** in standby mode.

Use **▲▼◀▶** to select an item.

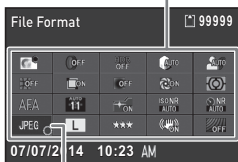

Use **○** to change settings.

Press **OK** to make detailed settings.

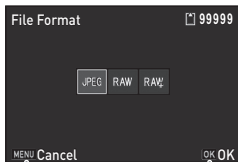

Press **MENU** to cancel setting operation.

Press **OK** to confirm the selected item and return to the control panel.

Most functions are set from the menu. The functions that can be set on the control panel can also be set from the menus.

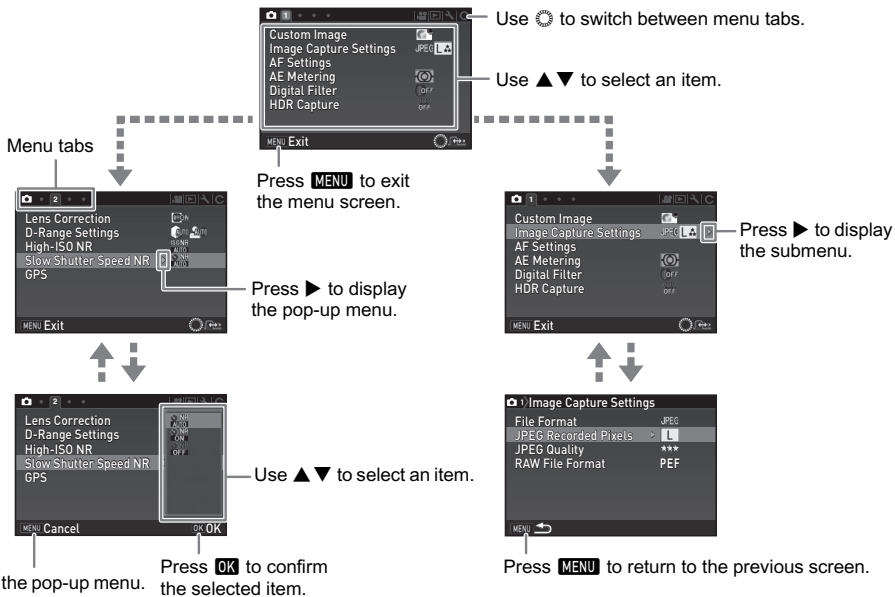



### Memo







- For the Custom Setting menus (C1-4), you can show the setting screen of the next item in order of the menus on the monitor by turning while the submenu of the currently selected item is displayed.
- Press **MENU** to display the first tab of the proper menu for the camera settings at that time. To display the menu tab last selected first, set in [23 Save Menu Location] of the C4 menu.
- Settings are returned to their default values with [Reset] of the menu. To reset all the settings in the Custom Setting menus to the defaults, use [Reset Custom Functions] of the C4 menu. (Some settings do not apply.)

# Menu List

## Rec. Mode Menus

Menu	Item	Function	Default Setting	Page	
 1	<b>Custom Image</b> *1 *4	Sets the image finishing tone such as color and contrast before shooting an image.	Bright	p.58	
	<b>Scene Mode</b> *2 *4	Selects the scene mode that best suits the situation. (SCN mode)	Portrait	p.39	
	<b>Effects Mode</b> *3 *4	Selects the special effects that can be added to pictures. (EFFECT mode)	Faded Color	p.41	
	<b>Image Capture Settings</b>	<b>File Format</b> *4	Sets the file format of images.	JPEG	p.38
		<b>JPEG Recorded Pixels</b> *4	Sets the recording size of images saved in JPEG format.	<input type="checkbox"/>	
		<b>JPEG Quality</b> *4	Sets the quality of images saved in JPEG format.	★★★	
		<b>RAW File Format</b>	Sets the RAW file format.	PEF	
	<b>AF Settings</b>	<b>AF Mode</b> *4	Selects the autofocus method when shooting with the viewfinder.	<b>AF.A</b>	p.49
		<b>AF Active Area</b> *4	Selects the area to adjust the focus when shooting with the viewfinder.	Auto (11 AF Points)	p.50
		<b>AF Assist Light</b> *4	Sets whether to use the assist light when autofocusing in dark locations.	On	p.49
	<b>AE Metering</b> *4	Selects the part of the sensor to use for measuring brightness and determining exposure.	Multi-segment	p.47	
	<b>Digital Filter</b> *4	Applies a digital filter effect when taking pictures.	No Filter	p.60	
	<b>HDR Capture</b>	<b>HDR Capture</b> *4	Sets the type of high dynamic range shooting.	Off	p.62
		<b>Bracket Value</b> *4	Sets the amount to change the exposure.	±2EV	
<b>Auto Align</b>		Sets whether to automatically adjust the composition.	On		

Menu	Item	Function	Default Setting	Page	
 2	Lens Correction	<b>Distortion Correction</b> *4	Reduces distortions occurring due to lens properties.	Off	p.62
		<b>Lat-Chromatic-Ab Adj</b> *4	Reduces lateral chromatic aberrations occurring due to lens properties.	On	
		<b>Peripheral Illumin. Corr.</b> *4	Reduces peripheral light fall-off occurring due to lens properties.	Off	
		<b>Diffraction Correction</b> *4	Corrects blur caused by diffraction when using a small aperture.	On	
	D-Range Settings	<b>Highlight Correction</b> *4	Expands the dynamic range and prevents overexposed areas from occurring.	Auto	p.61
		<b>Shadow Correction</b> *4	Expands the dynamic range and prevents underexposed areas from occurring.	Auto	
	<b>High-ISO NR</b> *4		Sets the Noise Reduction setting when shooting with a high ISO sensitivity.	Auto	p.46
	<b>Slow Shutter Speed NR</b> *4		Sets the Noise Reduction setting when shooting with a slow shutter speed.	Auto	p.43
	<b>GPS</b>		Sets the camera action when the optional GPS unit is used.	–	p.94
	 3	Live View	<b>Contrast AF</b> *4	Sets the AF Mode for shooting with Live View.	Face Detection
<b>Focus Peaking</b> *4			Emphasizes the outline of the subject in focus and makes it easier to check the focus.	Off	p.52
<b>Grid Display</b>			Displays the grid during Live View.	Off	p.11
<b>Histogram Display</b>			Displays the histogram during Live View.	Off	
<b>Highlight Alert</b>			Sets overexposed areas to blink red during Live View.	Off	
<b>AA Filter Simulator</b> *4		Applies low-pass filter effects using the Shake Reduction mechanism.	Off	p.63	
<b>Shake Reduction</b> *4		Activates the Shake Reduction function.	On	–	
<b>Input Focal Length</b>		Sets the focal length when using a lens of which focal length information cannot be obtained.	35mm	p.91	

Menu	Item	Function	Default Setting	Page	
 4	<b>Instant Review</b>	<b>Display Time</b>	Sets the Instant Review display time.	1sec.	p.35
		<b>Zoom Instant Review</b>	Sets whether to magnify the image during Instant Review.	On	
		<b>Save RAW Data</b>	Sets whether to save the RAW data during Instant Review.	On	
		<b>Delete</b>	Sets whether to allow deletion of the displayed image during Instant Review.	On	
		<b>Histogram Display</b>	Displays the histogram during Instant Review.	Off	
		<b>Highlight Alert</b>	Sets overexposed areas to blink red during Instant Review.	Off	
	<b>Button Customization</b>	<b>AF/AE-L Button</b>	Sets the function for when  is pressed.	Enable AF1	p.77
		<b>AF/AE-L Button(Movie)</b>	Sets the function for when  is pressed in  mode.	Enable AF1	
		<b>Green Button</b>	Sets the function for when  is pressed.	Green Button	
		<b>E-Dial Programming</b>	Reverses the direction of rotation to increase value when  is turned.	Rotate Right	
	<b>Memory</b>		Determines which settings to save when the power is turned off.	On for settings other than Digital Filter, HDR Capture, and Shooting Info Display	p.81



\*1 The function appears in modes other than **SCN** or **EFFECT** mode.

\*2 The function appears in **SCN** mode.

\*3 The function appears in **EFFECT** mode.

\*4 The functions can also be set from the control panel.

## Movie Menu

Menu	Item	Function	Default Setting	Page
 1	<b>Movie Capture Settings</b> *1	Sets the number of recorded pixels and the framerate of the movie.	 /30p	p.38
	<b>Recording Sound Level</b> *1	Sets the Recording Sound Level and the volume level for recording.	Auto	p.45
	<b>Digital Filter</b> *1	Applies a digital filter effect when recording a movie.	No Filter	p.60
	<b>Movie SR</b> *1	Activates the Movie Shake Reduction function.	On	-

\*1 The functions can also be set from the control panel.





## Playback Menu

Menu	Item	Function	Default Setting	Page	
 1	<b>Slideshow</b>	<b>Display Duration</b>	Sets an image display interval.	3sec.	p.67
		<b>Screen Effect</b>	Sets a transition effect when the next image is displayed.	Off	
		<b>Repeat Playback</b>	Starts the slideshow again from the beginning after the last image is displayed.	Off	
		<b>Auto Movie Playback</b>	Plays back movies during the slideshow.	On	
	<b>Quick Zoom</b>	Sets the initial magnification when magnifying images.	Off	-	
	<b>Highlight Alert</b>	Sets overexposed areas to blink red in Standard Information Display or Histogram Display in playback mode.	Off	-	
	<b>Auto Image Rotation</b>	Rotates images which were captured with the camera held vertically or of which the rotation information has been changed.	On	p.68	
	<b>Protect All Images</b>	Protects all stored images at once.	-	-	
	<b>Delete All Images</b>	Deletes all stored images at once.	-	-	



## Set-up Menus

Menu	Item	Function	Default Setting	Page	
1	<b>Language/言語</b>	Changes the display language.	English	p.32	
	<b>Date Adjustment</b>	Sets the date and time and the display format.	01/01/2014	p.33	
	<b>World Time</b>	Switches between the date and time display of your hometown city and that of a specified city.	Hometown	p.80	
	<b>Text Size</b>	Sets whether to magnify the text size when selecting a menu item.	Std.	p.33	
	<b>Sound Effects</b>	Switches the operation sound on/off and changes the volume for In-focus, AE-L, Self-timer, remote Control, Change AF Point, and One Push File Format operations.	Volume 3/ All On	-	
	<b>LCD Display</b>	<b>Guide Display</b>	Sets whether to display the operation guides when the capture mode is changed.	On	p.35
		<b>Display Color</b>	Sets the display color of the status screen, control panel and menu cursor.	1	p.12
	<b>LCD Display Settings</b>	Adjusts the brightness, saturation and the color of the monitor.	0	-	
2	<b>USB Connection</b>	Sets the USB connection mode when connecting to a computer.	MSC	p.70	
	<b>HDMI Out</b>	Sets the output format when connecting to an AV device with an HDMI input terminal.	Auto	p.69	
	<b>Folder Name</b>	Sets the folder name in which images are stored.	Date	p.82	
	<b>Create New Folder</b>	Creates a new folder on the memory card.	-	p.83	
	<b>File Name</b>	Sets the file name assigned to an image.	IMGP/_IMG	p.83	

Menu	Item	Function	Default Setting	Page	
2	File No.	Sequential Numbering	Sets whether to continue the sequential numbering for the file name when a new folder is created.	On	p.84
		Reset File Number	Resets the file number setting and returns to 0001 each time a new folder is created.	-	
	Copyright Information	Sets the photographer and copyright information embedded in the Exif data.	Off	p.85	
3	Flicker Reduction	Cuts down on the screen flicker by setting the power frequency.	50Hz	-	
	Auto Power Off	Sets the time until the camera turns off automatically if no operations are made for a certain period of time.	1min.	p.32	
	Indicator Lamps	Other Indicator Lamps	Lights up the main switch lamp, mode dial lamp, <b>OK</b> lamp, and grip lamps when the power is turned on.	High	p.9
		Self-timer	Lights up the grip lamps during the countdown for Self-timer shooting.	On	
		Remote Control	Lights up the grip lamps when shooting with a remote control unit.	On	
	Wireless Memory Card	Sets the camera action for when an Eye-Fi card or a Flucard is used.	-	p.86	
	Reset	Resets the settings of the direct keys and for the items of the  menu,  menu,  menu,  menu, control panel, and playback mode palette.	-	-	
4	Pixel Mapping	Maps out and corrects any defective pixels on the CMOS sensor.	-	p.95	
	Dust Removal	Cleans the CMOS sensor by shaking it.	Off	p.95	
	Sensor Cleaning	Locks the mirror in the up position for cleaning the CMOS sensor with a blower.	-	p.96	
	Format	Formats a memory card.	-	p.34	
	Firmware Info/Options	Displays the camera's firmware version. You can check the current firmware version before running an update.	-	-	

## Custom Setting Menus

Menu	Item	Function	Default Setting	Page
C1	<b>1 EV Steps</b>	Sets the adjustment steps for exposure.	1/3 EV Steps	p.43
	<b>2 Sensitivity Steps</b>	Sets the adjustment steps for ISO sensitivity.	1 EV Step	p.46
	<b>3 Meter Operating Time</b>	Sets the meter operating time.	10sec.	–
	<b>4 AE-L with AF Locked</b>	Sets whether to lock the exposure value when the focus is locked.	Off	–
	<b>5 Link AE and AF Point</b>	Sets whether to link the exposure and AF point in the focusing area.	Off	p.47
	<b>6 Auto EV Compensation</b>	Sets whether to automatically compensate when the proper exposure cannot be determined.	Off	–
	<b>7 Bulb (B) Mode Options</b>	Sets the camera operation when pressing <b>SHUTTER</b> in <b>B</b> mode.	Type1	–
C2	<b>8 Bracketing Order</b>	Sets the order for Exposure Bracketing shooting.	0 - +	p.55
	<b>9 One-Push Bracketing</b>	Sets whether to shoot all frames with one release when using Exposure Bracketing.	Off	p.55
	<b>10 WB Adjustable Range</b>	Sets whether to automatically fine-tune the white balance when the light source is specified for the white balance setting.	Fixed	p.56
	<b>11 WB When Using Flash</b>	Sets the white balance setting for when using a flash.	Auto White Balance	p.56
	<b>12 AWB in Tungsten Light</b>	Sets the tungsten light color tone for when the white balance is set to [Auto White Balance].	Strong Correction	p.56
	<b>13 Color Temperature Steps</b>	Sets the adjustment steps for color temperature.	Kelvin	p.58
	<b>14 Superimpose AF Area</b>	Sets whether to display the active AF point in red in the viewfinder.	On	p.16

Menu	Item	Function	Default Setting	Page
C3	<b>15 AF.S Setting</b>	Sets the action priority for when the focus mode is set to <b>AF.S</b> and <b>SHUTTER</b> is fully pressed.	Focus-priority	p.50
	<b>16 1st Frame Action in AF.C</b>	Sets the action priority for the first frame when the focus mode is set to <b>AF.C</b> and <b>SHUTTER</b> is fully pressed.	Release-priority	p.50
	<b>17 Action in AF.C Continuous</b>	Sets the action priority during Continuous Shooting when the focus mode is set to <b>AF.C</b> .	Focus-priority	p.50
	<b>18 Hold AF Status</b>	Sets whether to maintain the focus for a certain amount of time when the subject happens to move out of the selected focusing area after being focused.	Off	p.50
	<b>19 AF with Remote Control</b>	Sets whether to use autofocus when shooting with a remote control unit.	Off	p.55
	<b>20 Release While Charging</b>	Sets whether to release the shutter while the built-in flash is being charged.	Off	p.48
	<b>21 Color Space</b>	Sets the color space to use.	sRGB	–
C4	<b>22 Save Rotation Info</b>	Sets whether to save rotation information when shooting.	On	p.68
	<b>23 Save Menu Location</b>	Saves the last menu tab displayed on the monitor and displays it again the next time <b>MENU</b> is pressed.	Reset Menu Location	p.18
	<b>24 Catch-in Focus</b>	Sets whether to enable Catch-in Focus shooting when a manual focus lens is attached. The shutter is released automatically when the subject comes into focus.	Off	–
	<b>25 AF Fine Adjustment</b>	Allows you to precisely fine tune your lenses with the camera's autofocus system.	Off	p.53
	<b>26 Using Aperture Ring</b>	Sets whether to enable the shutter to release when the lens aperture ring is set to a position other than <b>A</b> (Auto).	Disable	p.92
	<b>Reset Custom Functions</b>	Resets all the settings of the Custom Setting menus to the defaults.	–	–

## Attaching the Strap

- 1 Pass the end of the strap through the strap lug and secure it on the inside of the clasp.

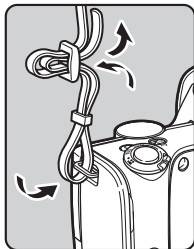

- 2 Attach the other end in the same manner.

## Attaching a Lens

- 1 Make sure that the camera is turned off.
- 2 Remove the body mount cover (1) and lens mount cover (2).

After removing the cover, be sure to put the lens down with the lens mount side facing upward.

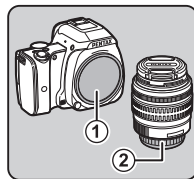

- 3 Align the lens mount index (red dots: 3) on the camera and the lens, and secure by turning the lens clockwise until it clicks.

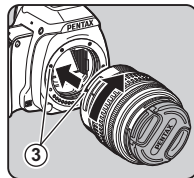

### To remove the lens

Attach the lens cap, and then turn the lens counterclockwise while pressing the lens unlock button (4).

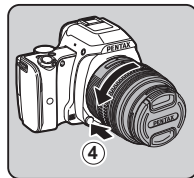

### ⚠ Caution

- When attaching or removing the lens, choose an environment that is relatively free of dirt and dust.
- Keep the body mount cover attached on the camera when a lens is not attached.
- Be sure to attach the lens mount cover and lens cap to the lens after removing it from the camera.
- Do not insert your fingers inside the lens mount of the camera or touch the mirror.
- The camera body and lens mount incorporate lens information contacts. Dirt, dust, or corrosion may damage the electrical system. Please contact your nearest service center for professional cleaning.
- We assume no responsibility nor liability for accidents, damages and malfunctions resulting from the use of lenses made by other manufacturers.

### 📄 Memo

- Refer to "Functions Available with Various Lenses" (p.90) for details on the functions of each lens.

## Using the Battery and Charger

Use the battery D-LI109 and battery charger D-BC109 exclusively developed for this camera.

### Charging the Battery

- 1 Connect the AC plug cord to the battery charger.**
- 2 Plug the AC plug cord into the power outlet.**

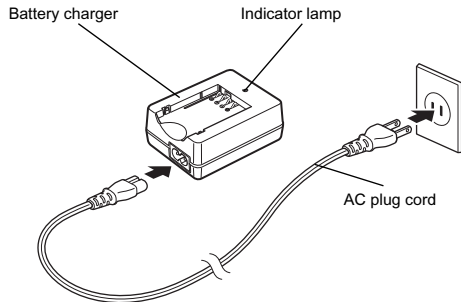

### 3 Face the ▲ mark on the battery up, and insert it into the battery charger.

Insert the battery into the battery charger at an angle, and then fit into place.

The indicator lamp is lit while charging and turns off when the battery is fully charged.

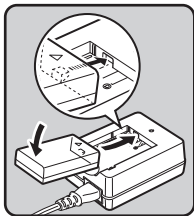

#### ⚠ Caution

- Do not use the battery charger D-BC109 to charge batteries other than D-LI109. Charging other batteries may cause damage or heating.
- Replace the battery with a new one in the following cases:
  - If the indicator lamp blinks or does not light after the battery is inserted correctly
  - If the battery starts to run down more quickly even after being charged (the battery may have reached the end of its service life)

#### 📄 Memo

- The maximum charging time is approximately 240 minutes (it depends on temperature and remaining battery power). Charge in a location where the temperature is between 0°C and 40°C (32°F and 104°F).

## Inserting/Removing the Battery

#### ⚠ Caution

- Insert the battery correctly. If the battery is inserted incorrectly, it may not be removed.
- Wipe the electrodes of the battery with a soft dry cloth before inserting.
- Do not open the battery/memory card cover or remove the battery while the power is on.
- Be careful as the camera or battery may become hot after the camera has been used continuously for a long period of time.
- Remove the battery when you will not use the camera for a long time. The battery may leak and damage the camera if left installed during prolonged periods of non-use. If the removed battery will not be used for six months or longer, charge the battery for about 30 minutes before storing it. Be sure to recharge the battery every six to twelve months.
- Store the battery in a location where the temperature will remain at or below room temperature. Avoid locations with high temperatures.
- The date and time may be reset if you leave the battery out of the camera for long periods of time. If this happens, set the current date and time again.

### 1 Open the battery/memory card cover.

Slide the battery/memory card cover unlock lever (1) before opening the cover.

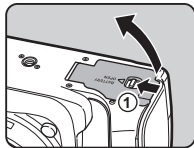

- 2** Face the ▲ mark on the battery towards the lens, and insert the battery until it locks into place.

To remove the battery, push the battery lock lever in the direction of ②.

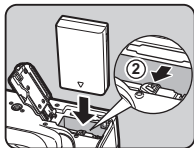

- 3** Close the battery/memory card cover.

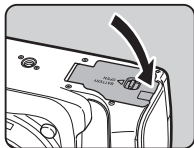

#### ● Memo

- The battery level may not be displayed properly if the camera is used at low temperatures or when performing Continuous Shooting for a long time.
- Battery performance temporarily decreases as the temperature decreases. When using the camera in cold climates, have extra batteries at hand and keep them warm in your pocket. Battery performance will return to normal at room temperature.
- Have extra batteries ready when traveling overseas, or taking a lot of pictures.

## Using the AC Adapter

We recommend the use of the optional AC adapter kit K-AC128 when using the monitor for a long time or when connecting the camera to a computer or AV device.

- 1** Make sure that the camera is turned off.
- 2** Open the battery/memory card cover.  
Remove the battery if it is inserted in the camera.
- 3** Pull out the connection cable cover (①) on the right side of the battery/memory card cover.

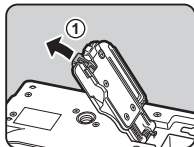

- 4** Insert the DC coupler into the battery chamber.

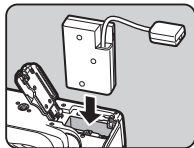

- 5** Close the battery/memory card cover.

Make sure that the connection cable comes out from the connection cable cover section.

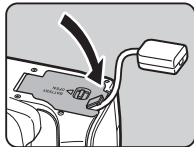



## 6 Connect the DC coupler and the AC adapter.

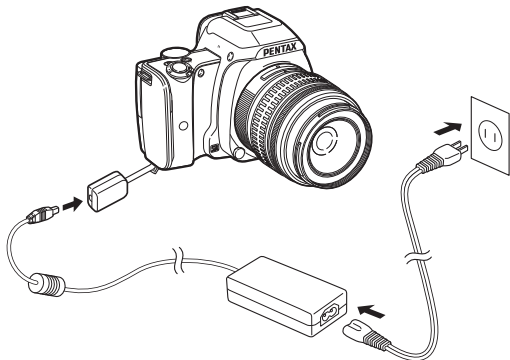

## 7 Connect the AC adapter to the AC plug cord, and plug the cord into the power outlet.

### ⚠ Caution

- Make sure that the camera is turned off before connecting or disconnecting the AC adapter.
- Make sure that connections are secure between the terminals. The memory card or data may be corrupted if the connection to the power supply is lost while the card is being accessed.
- After removing the DC coupler, return the connection cable cover to its original position.
- Be sure to read the manual of the AC adapter kit before using the AC adapter.

## Inserting a Memory Card

The following memory cards can be used with this camera.

- SD Memory Card, SDHC Memory Card, and SDXC Memory Card
- Eye-Fi card
- Flucard compatible with this camera

In this manual, these cards are referred to as memory cards.

- 1 Make sure that the camera is turned off.
- 2 Open the battery/memory card cover.

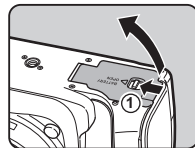

- 3 Insert the card all the way into the memory card slot with the memory card label facing toward the monitor.

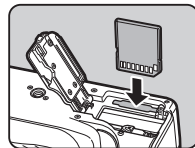

Push the memory card in once and release to remove.

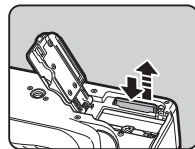

#### 4 Close the battery/memory card cover.

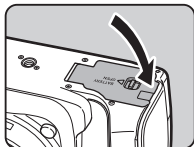

#### ⚠ Caution

- Do not remove the memory card while the card access lamp (orange) is lit.
- If the battery/memory card cover is opened while the power is on, the camera turns off. Do not open the cover while the camera is in use.
- Use this camera to format (initialize) a memory card that is unused or has been previously used on other devices. (p.34)
- Use a high-speed memory card when recording movies. If the write speed cannot keep up with the recording speed, the writing may stop during recording.

#### 📄 Memo

- When using an Eye-Fi card or a Flucard, refer to "Using a Wireless Memory Card" (p.86).

## Initial Settings

Turn the camera on and make the initial settings.

### Turning the Camera On

#### 1 Turn the main switch to [ON].

The lamp lights up in green. The first time the camera is turned on after purchase, the [Language/言語] screen appears.

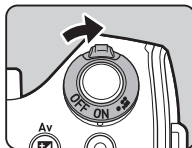

#### 📄 Memo

- The power automatically turns off when you do not perform any operations within a set period of time. (Default setting: 1min.) You can change the setting in [Auto Power Off] of the 3 menu. (p.24)

### Setting the Display Language

#### 1 Use to select the desired language and press .

The [Initial Setting] screen appears in the selected language.

Proceed to Step 6 if (Hometown) does not need to be changed.

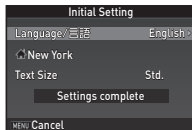

#### 2 Press to move the frame to and press .

The [ Hometown] screen appears.

- 3 Use ◀▶ to select a city.**  
Use ⌚ to change the region.  
Refer to “List of World Time Cities” (p.103) for cities that can be selected as a hometown.

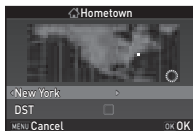

- 4 Press ▼ to select [DST] (daylight saving time), and use ◀▶ to select  or .**

- 5 Press OK.**  
The camera returns to the [Initial Setting] screen.

- 6 Press ▼ to select [Text Size] and press ▶.**

- 7 Use ▲▼ to select [Std.] or [Large], and press OK.**  
Selecting [Large] increases the text size of the selected menu items.

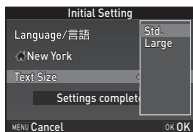

- 8 Press ▼ to select [Settings complete] and press OK.**  
The [Date Adjustment] screen appears.

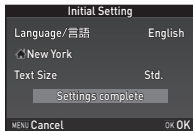

## Setting the Date and Time

- 1 Press ▶, and use ▲▼ to select the date format.**

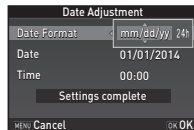

- 2 Press ▶, and use ▲▼ to select 24h or 12h.**

- 3 Press OK.**  
The frame returns to [Date Format].

- 4 Press ▼, and then press ▶.**

The frame moves to the month if the date format is set to [mm/dd/yy].

- 5 Use ▲▼ to set the month.**  
Set the day, year and time in the same manner.

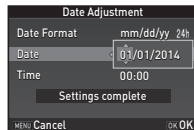

- 6 Press ▼ to select [Settings complete] and press OK.**  
The [LCD Display] screen appears.

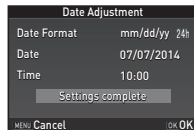

## Setting the LCD Display

### 1 Use ◀▶ to select a color.

Select the display color of the status screen, control panel and menu cursor from colors 1 to 12.

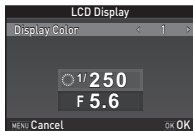

### 2 Press OK.

The camera switches to capture mode and is ready to take a picture.

#### Memo

- You can change the language, text size, date and time, and LCD display settings from the ↶4 menu. (p.23)

## Formatting a Memory Card



### 1 Press MENU.

The ↶1 menu appears.

### 2 Use ⦿ to display ↶4 menu.

### 3 Use ▲▼ to select [Format] and press ▶.

The [Format] screen appears.

### 4 Press ▲ to select [Format] and press OK.

Formatting starts.

When formatting is completed, the ↶4 menu reappears.

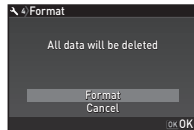

### 5 Press MENU twice.

#### Caution

- Do not remove the memory card while formatting, or the card may be damaged.
- Formatting deletes all data, both protected and unprotected.

#### Memo

- When a memory card is formatted, the volume label "K-S1" is assigned to the card. When the camera is connected to a computer, the memory card is recognized as a removable disk with the name "K-S1".

## Basic Shooting Operation

Take pictures using the Auto Picture (**AUTO**) mode in which the camera automatically selects the optimal capture mode.

- 1 Remove the front lens cap by pushing the top and bottom portions as indicated in the illustration.

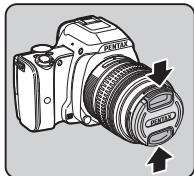

- 2 Turn the camera on.

- 3 Set the focus mode switch to AF.

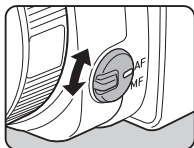

- 4 Turn the mode dial so that **AUTO** is at the top of the dial. **AUTO** lights up in green.

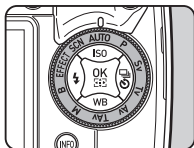

The selected capture mode is displayed on the monitor (Guide Display).

- 5  Guide Display settings (p.23)

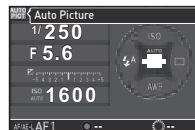

- 5 Look through the viewfinder to view the subject.

When using a zoom lens, turn the zoom ring to the right or left to change the angle of view.

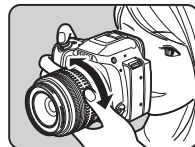

- 6 Position the subject inside the AF frame and press **SHUTTER** halfway.

● appears and you will hear a beep when the subject comes into focus.

- 6  Setting the Sound Effects (p.23)





Focus indicator

- 7 Press **SHUTTER** fully.

The captured image is displayed on the monitor (Instant Review).

### Available operations during Instant Review

-  Deletes the image.
-  Magnifies the image.
-  Saves the RAW data of the last JPEG image taken.

- 7  Setting the display for Instant Review (p.21)

## Shooting with Live View

### 1 Press **[LV]** in Step 5 of "Basic Shooting Operation" (p.35).

The Live View image is displayed on the monitor.

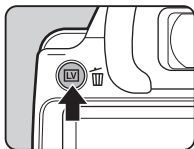

### 2 Position the subject inside the AF frame on the monitor and press **SHUTTER** halfway.

The AF frame turns green and you will hear a beep when the subject comes into focus.



AF frame

### Available operations during Live View

- [OK]** Magnifies the image.  
 Use **[ZOOM]** to change the magnification (up to 10×).  
 Use **[UP]** **[DOWN]** **[LEFT]** **[RIGHT]** to change the area to display.  
 Press **[C]** to return the display area to the center.  
 Press **[OK]** to return to 1× image display.

- [LV]** Exits the Live View shooting.

Subsequent steps are the same as shooting with the viewfinder.

### Memo

- You can use the **[AF/AE-L]** button to focus on the subject. (p.49)
- You can set the operation and display settings during Instant Review in [Instant Review] of the **[M4]** menu. (p.21) When [Display Time] is set to **[HOLD]**, Instant Review will be displayed until the next operation.

## Reviewing Images

Review the captured image on the monitor.

### 1 Press .

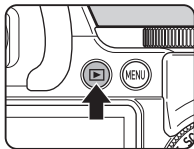













The camera enters playback mode and the most recently captured image is displayed (single image display).



### 2 Review the captured image.

#### Available operations

	Displays the previous image.
	Displays the next image.
	Deletes the image.
 to the right	Magnifies the image (up to 16×). Use     to change the area to display. Press  to return the display area to the center. Press <b>OK</b> to return to the entire image display.

 to the left	Switches to the thumbnail display (p.65).
	Saves the RAW data (only when a JPEG image was taken and the data remains in the buffer).
<b>INFO</b>	Changes the type of information displayed (p.13).
	Displays the playback mode palette (p.64).

#### Memo

- When  **RAW** is displayed on the monitor, the JPEG image that was just taken can also be saved in RAW format (Save RAW Data).

## Configuring the Capture Settings

### Image Capture Settings



Set the file format, recorded pixels, and quality level for still pictures in the control panel or [Image Capture Settings] of the 1 menu.

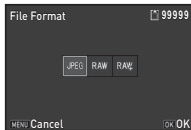

<b>File Name</b>	JPEG, RAW, RAW+
<b>JPEG Recorded Pixels</b>	[L], [M], [S], [XS]
<b>JPEG Quality</b>	★★★, ★★, ★
<b>RAW File Format</b>	PEF, DNG

#### Memo

- When [File Format] is set to [RAW+], a JPEG image and a RAW image with the same file number are saved at the same time.
- [PEF] of [RAW File Format] is a PENTAX original RAW file format.

## Movie Capture Settings



Set the file format for movies in the control panel or [Movie Capture Settings] of the 1 menu.

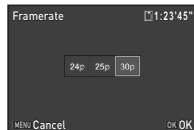

Recorded Pixels	Framerate
FullHD	30p, 25p, 24p
HD	60p, 50p



## Taking Still Pictures

Select the capture mode that suits the subject and shooting conditions.

The following capture modes are available on this camera.

Capture Mode	Application	Page
<b>AUTO</b> <b>(Auto Picture modes)</b>	Automatically selects the optimal capture mode from ☺ (Standard), 🗺️ (Portrait), 🏞️ (Landscape), 🔍 (Macro), 🏃 (Moving Object), 🌃 (Night Scene Portrait), 🌅 (Sunset), 🌤️ (Blue Sky) or 🌲 (Forest).	p.35
<b>SCN</b> <b>(Scene modes)</b>	Offers you various scene modes to choose from.	p.39
<b>EFFECT</b> <b>(Effects modes)</b>	Takes images using various effects.	p.41
<b>P/Sv/Tv/Av/ TAv/M/B</b> <b>(Exposure modes)</b>	Changes the shutter speed, aperture value, and sensitivity.	p.42

### 📌 Memo

- The functions that can be set vary depending on the capture mode. Refer to "Restrictions on Each Capture Mode" (p.88) for details.

## Scene Modes













### 1 Set the mode dial to SCN.

The scene mode selection screen appears.

### 2 Select a scene mode.



<b>Portrait</b>	For capturing portraits. Reproduces a healthy and bright skin tone.
<b>Landscape</b>	For capturing landscape views. Reproduces the vivid green of trees.
<b>Macro</b>	For capturing tiny objects at close focus range like flowers, coins, jewelry, and more.
<b>Moving Object</b>	For capturing images of fast moving subjects.
<b>Night Scene Portrait</b>	For capturing images of people in low light conditions, such as dusk or at night.
<b>Sunset</b>	For capturing sunrises or sunsets in beautiful, vivid color.
<b>Blue Sky</b>	For capturing images of blue sky. Produces a more impressive deep blue.

 <b>Forest</b>	Enhances colors of trees and sunbeams through foliage and produces a vivid color image.
 <b>Night Scene</b>	Used for shooting at night.
 <b>Night Scene HDR</b>	Takes three consecutive images at three different exposure levels to create a single composite image from them.
 <b>Night Snap</b>	For taking snapshots in poorly lit place.
 <b>Food</b>	For capturing images of food. Saturation will be rather high to make food look appetizing.
 <b>Pet</b>	For capturing moving pets.
 <b>Kids</b>	For capturing moving kids. Reproduces healthy and bright skin tone.
 <b>Surf &amp; Snow</b>	For capturing images of dazzling backgrounds, such as snowy mountains.
 <b>Backlight Silhouette</b>	Produces a silhouette image of subject in backlight condition.
 <b>Candlelight</b>	For capturing scenes in candlelight.
 <b>Stage Lighting</b>	For capturing moving subjects in poorly lit place.
 <b>Museum</b>	For capturing images in places where a flash is prohibited.

### 3 Press **OK**.

The camera is in standby mode.

Turn  to change the scene mode.

### **Memo**

- You can change the scene mode also from the control panel or the  1 menu.

## Effects Modes

### 1 Set the mode dial to EFFECT.

The effects mode palette appears.

### 2 Select an effects mode.

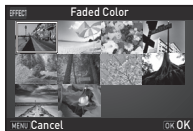

Faded Color

Clear Tone

Brilliant Color

Unicolor Bold

Vintage Color

Cross Processing

Warm Fade

Bold Monochrome

Infrared Filter

Vibrant Color Enhance

### 3 Press **OK**.

The camera is in standby mode.

Turn  to change the effects mode.

### 4 Press **▼** to change the parameters.

The parameter setting screen appears.

### 5 Use **◀▶** to change the parameters.

When shooting with the viewfinder, press  to display the preview.

When shooting with Live View, the image is displayed with the selected effects applied.

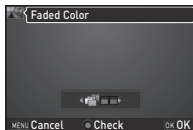

### 6 Press **OK**.

The camera returns to standby mode.

### Memo

- You can change the effects mode also from the control panel or the  1 menu.
- During Live View, the design of the effects mode palette differs from the one shown in Step 2.

### Caution

- Since the **EFFECT** mode uses a specific combination of White Balance, Custom Image, and Digital Filter, you cannot set these settings by choice.

## Exposure Modes

✓: Available   #: Restricted   ✕: Not available

Mode	Change Shutter Speed	Change Aperture Value	Change Sensitivity	EV Compensation
<b>P</b> Program Automatic Exposure	# *1	# *1	✓	✓
<b>Sv</b> Sensitivity Priority Automatic Exposure	✕	✕	✓ *2	✓
<b>Tv</b> Shutter Priority Automatic Exposure	✓	✕	✓	✓
<b>Av</b> Aperture Priority Automatic Exposure	✕	✓	✓	✓
<b>TAv</b> Shutter & Aperture Priority Automatic Exposure	✓	✓	✓ *3	✕
<b>M</b> Manual Exposure	✓	✓	✓ *2	✕
<b>B</b> Bulb Exposure	✕	✓	✓ *2	✕

\*1 You can set the value to be changed in [Button Customization] of the 4 menu. (p.79)

\*2 [ISO AUTO] is not available.

\*3 Fixed to [ISO AUTO].

## 1 Turn the mode dial to select the desired exposure mode.

appears on the status screen for the value that can be changed.

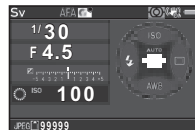

The value that can be changed is underlined in the viewfinder.

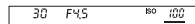

During Live View, appears for the value that can be changed.



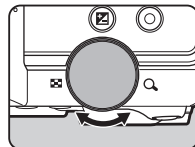

## 2 Turn .

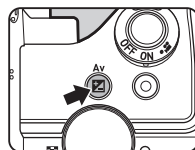

In **TAv/M** mode, press to select the value to be changed.





## Memo

- The settings for exposure can be specified in increments of 1/3 EV steps. In [1 EV Steps] of the **C1** menu, you can change the adjustment steps to 1/2 EV steps.
- A proper exposure may not be obtained with the selected shutter speed and aperture value when the sensitivity is set to a certain sensitivity.
- In **M** mode, the difference from the proper exposure is displayed on the EV bar scale while exposure is adjusted.
- In **B** mode, [Drive Mode] cannot be set to [Continuous Shooting] or [Exposure Bracketing].
- You can set the function of the  button for when the camera is in **M/TAv** mode. Set in [Button Customization] of the 4 menu. (p.79)
- When shooting with a low shutter speed, you can reduce image noise from the control panel or [Slow Shutter Speed NR] of the 2 menu.

<b>Auto</b>	Applies Noise Reduction according to the shutter speed, sensitivity, and internal temperature of the camera.
<b>On</b>	Applies Noise Reduction when the shutter speed is slower than 1 second.
<b>Off</b>	Does not apply Noise Reduction at any shutter speed.

## Checking the Depth of Field (Preview)

When [Optical Preview] or [Digital Preview] is assigned to  in [Green Button] of [Button Customization] in the 4 menu, you can check the depth of field before taking pictures. (p.77)

## EV Compensation

The compensation value can be set between -5 and +5 EV (-2 and +2 EV in  mode).

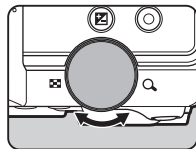
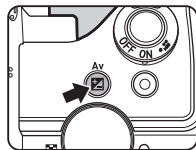

1 Press , and then turn .

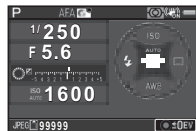

 and the compensation value are displayed on the status screen, Live View screen, and in the viewfinder during adjustment.



## Available operations

-  Starts/ends adjusting the compensation value.
-  Resets the adjustment value to the default setting.

### ● Memo

- Exposure Bracketing shooting enables you to take pictures while automatically changing exposure. (p.55)

#### Locking the Exposure

To lock the exposure before shooting, use [AE Lock]. The AE Lock function can be used by assigning it to the **AF/AE-L** button. (p.77)

## Recording Movies

- 1 Turn the main switch to .

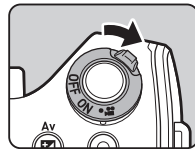

The lamp lights red and the Live View image is displayed.

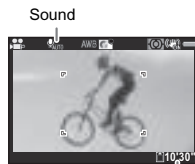

Recordable Time

- 2 Turn the mode dial to select the desired capture mode.

The following settings are available depending on the capture mode.

EFFECT	Select an effects mode.
<b>Av/TAv/M</b>	Set the exposure. (The aperture value can be set only before shooting. In <b>M</b> mode, the sensitivity can also be changed.)
<b>Other modes</b>	The camera operates in <b>P</b> mode.

### 3 Focus on the subject.

In **AF** mode, press **SHUTTER** halfway.

### 4 Press **SHUTTER** fully.

Movie recording starts.

In the upper left area of the monitor, "REC" blinks and the size of the file being recorded is displayed.

### 5 Press **SHUTTER** fully again.

Movie recording stops.

### 6 Return the main switch to the [ON] position to exit **Ⓜ** mode.

The camera returns to shooting with the viewfinder in **📷** mode.

#### ⚠ Caution

- When recording a movie with sound, the camera operation sounds are also recorded.
- When recording a movie with an image processing function such as Digital Filter applied, the movie file may be saved with some frames omitted.
- If the internal temperature of the camera becomes high during recording, the recording may be terminated.

#### 📌 Memo

- You can change the movie settings from the control panel or the **Ⓜ** 1 menu. (p.22)
- The sound level for the recording can be set from the control panel or [Recording Sound Level] of the **Ⓜ** 1 menu. When [Manual] is selected, [Volume] can be set from 0 to 5.
- You can record a movie continuously up to 4 GB or 25 minutes. When the memory card is full, recording stops.

## Playing Back Movies

### 1 Display the movie to play back in single image display of the playback mode.



#### Available operations

▲	Plays back/pauses a movie.
▶	Forwards a frame (when paused).
Press and hold ▶	Fast-forwards playback.
◀	Reverses a frame (when paused).
Press and hold ◀	Fast-reverses playback.
▼	Stops playback.
⊙	Adjusts the volume (6 levels).
📷	Saves the displayed frame as a JPEG file (when paused).

#### 📌 Memo

- In [Movie Edit] of the playback mode palette, movies can be divided or selected frames can be deleted. (p.73)

## Setting the Exposure

### Sensitivity



1 Press **▲** in standby mode.

2 Use **▲▼** to select an item.

<b>ISO AUTO</b>	Sets the range to be adjusted automatically. The upper limit can be changed.
<b>ISO</b>	Sets a fixed value between ISO 100 to ISO 51200.

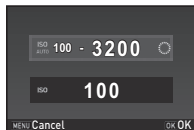

3 Use **○** to change the value.

4 Press **OK**.

The camera returns to standby mode.

### Memo

- The adjustment steps for ISO sensitivity is 1 EV step. To adjust the sensitivity in accordance with the EV step setting for exposure, set from [2 Sensitivity Steps] of the **C1** menu.

## Noise Reduction when Shooting with a High ISO Sensitivity



You can set the Noise Reduction setting when shooting with a high ISO sensitivity in the control panel or [High-ISO NR] of the **Q2** menu.

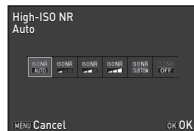

<b>Auto</b>	Applies Noise Reduction at optimally calculated levels throughout ISO range.
<b>Low/Medium/High</b>	Applies Noise Reduction at constant chosen level throughout ISO range.
<b>Custom</b>	Applies Noise Reduction at user-defined levels for each ISO setting.
<b>Off</b>	Does not apply Noise Reduction at any ISO setting.

When [Custom] is selected, the noise reduction level can be set according to the ISO sensitivity in the **Q2** menu.

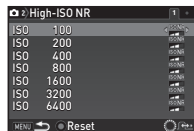



## AE Metering



Choose the part of the sensor to use for measuring brightness and determining exposure.

Set in the control panel or [AE Metering] of the 1 menu.

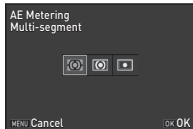

<b>Multi-segment</b>	Meters the brightness in multiple different zones of the sensor. In backlit locations, this mode automatically adjusts exposure.
<b>Center-weighted</b>	Meters the brightness with an emphasis on the center of the sensor. The sensitivity increases at the center and no automatic adjustment is performed even in backlit conditions.
<b>Spot</b>	Meters the brightness only within a limited area at the center of the sensor. Useful when the subject is small.

### Memo

- In [5 Link AE and AF Point] of the **C1** menu, the metering point and the AF point can be linked.

## Using the Built-in Flash



- 1 Press in standby mode.
- 2 Select a flash mode.



<b>Auto Flash Discharge</b>	Automatically measures the ambient light and determines whether to use the flash.
<b>Auto Flash +Red-eye Reduction</b>	Discharges a pre-flash for red-eye reduction before an automatic flash.
<b>Flash On</b>	Discharges a flash for each picture.
<b>Flash On+Red-eye Reduction</b>	Discharges a pre-flash for red-eye reduction before the main flash and discharges a flash for each picture.
<b>Slow-speed Sync</b>	Sets to a slow shutter speed. Use this, for example, when shooting a portrait with the sunset in the background.
<b>Slow-speed Sync+Red-eye</b>	Discharges a pre-flash for red-eye reduction before the main flash is discharged with Slow-speed Sync.
<b>Trailing Curtain Sync</b>	Discharges a flash immediately before closing the shutter. Sets to a slow shutter speed. Captures moving objects as if they are leaving a light trail behind them.
<b>Manual Flash Discharge</b>	Sets the amount of flash discharge between FULL and 1/128 power.

### 3 To compensate the flash output or when $\mathcal{L}_M$ is selected, press $\blacktriangledown$ and then use $\odot$ to adjust the value.

Press  $\odot$  to reset to the default setting.



### 4 Press $\text{OK}$ .

The camera returns to standby mode.

### 5 Press $\mathcal{L}$ .

The built-in flash is popped up.

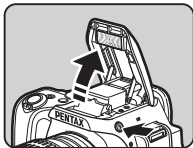

### $\odot$ Memo

- The flash modes that can be selected vary depending on the capture mode.

Capture Mode	Selectable Flash Mode
AUTO, SCN <sup>*1</sup>	$\mathcal{L}_A$ , $\mathcal{L}_A$ , $\mathcal{L}$ , $\mathcal{L}_\odot$
EFFECT, P, Sv, Av	$\mathcal{L}$ , $\mathcal{L}_\odot$ , SLOW, SLOW, SLOW, $\mathcal{L}_M$
Tv, TAv, M, B	$\mathcal{L}$ , $\mathcal{L}_\odot$ , $\mathcal{L}_M$ , $\mathcal{L}_M$

<sup>\*1</sup> The flash is not available in some scene modes. (p.88)

- You cannot take pictures while the flash is being charged. If you want to take pictures while charging the flash, set [20 Release While Charging] in the **C3** menu.
- Depending on the lens being used, the use of the built-in flash may be limited. (p.91)

- When the built-in flash is used in **Av** mode, the shutter speed automatically changes over a range from 1/180 seconds to a slow shutter speed depending on the lens being used. The shutter speed is locked at 1/180 seconds when a lens other than a DA, DA L, D FA, FA J, FA or F lens is used.
- When the built-in flash is used in **Tv**, **TAv** or **M** mode, any desired shutter speed of 1/180 seconds or slower can be set.
- The built-in flash is optimum for a subject at a distance from approx. 0.7 m to 5 m. Vignetting may occur when used at a distance closer than 0.7 m (this distance varies slightly depending on the lens being used and the sensitivity setting).

Sensitivity	Guide Number	Sensitivity	Guide Number
ISO 100	Approx. 10	ISO 3200	Approx. 56.6
ISO 200	Approx. 14.1	ISO 6400	Approx. 80
ISO 400	Approx. 20	ISO 12800	Approx. 113
ISO 800	Approx. 28.3	ISO 25600	Approx. 160
ISO 1600	Approx. 40	ISO 51200	Approx. 226

- For details on using an external flash, refer to "Functions when Using an External Flash" (p.93).

## Setting the Focus Method

Set the focus mode switch to **AF** or **MF**.

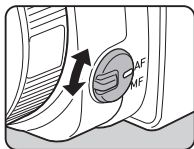

The autofocus method for shooting with the viewfinder differs from that for shooting with Live View.

<p><b>Shooting with the viewfinder</b></p>	<p>TTL phase-matching autofocus: Select from <b>A.F.S.</b>, <b>A.F.C.</b>, or <b>A.F.A</b> mode which enables automatically switching between <b>A.F.S.</b> and <b>A.F.C.</b>. (p.49) Set the focusing area in [AF Active Area]. (p.50) Faster autofocus performance than “contrast detection AF” is possible.</p>
<p><b>Shooting with Live View</b></p>	<p>Contrast detection AF: Face Detection and Tracking are available. (p.51)</p>

### Memo

- You can use **AF/AE-L** to focus on the subject. The **AF/AE-L** button operation can be set in [Button Customization] of the  4 menu. (p.77)

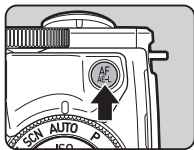

## Setting the AF Mode when Shooting with the Viewfinder



- 1 Press **INFO** in standby mode.
- 2 Select **[AF Mode]** and press **OK**.  
The [AF Mode] screen appears.
- 3 Select an autofocus mode and press **OK**.

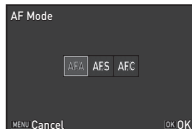

<p><b>AF.A</b> <b>Auto-select mode</b></p>	<p>Switches automatically between <b>A.F.S.</b> and <b>A.F.C.</b> modes according to the subject.</p>
<p><b>A.F.S.</b> <b>Single mode</b></p>	<p>When <b>SHUTTER</b> is pressed halfway and the subject comes into focus, the focus is locked at that position. The AF assist light turns on as necessary.</p>
<p><b>A.F.C.</b> <b>Continuous mode</b></p>	<p>The subject is kept in focus by continuous adjustment while <b>SHUTTER</b> is pressed halfway.  appears in the viewfinder when the subject comes into focus. The shutter can be released even if the subject is not in focus.</p>

The control panel reappears.

## 4 Press **MENU**.

The camera returns to standby mode.

### ● Memo

- The following settings for autofocus operation can be set in the **C3** menu.

<b>15 AF.S Setting</b>	Focus-priority, Release-priority
<b>16 1st Frame Action in AF.C</b>	Release-priority, Auto, Focus-priority
<b>17 Action in AF.C Continuous</b>	Focus-priority, Auto, FPS-priority
<b>18 Hold AF Status</b>	Off, Low, Medium, High

- In [18 Hold AF Status], you can set whether to immediately reactivate autofocus or to maintain the focus for a certain amount of time before activating autofocus when the subject happens to move out of the selected focusing area after being focused. The default setting is to immediately activate autofocus when focusing is unsuccessful.
- In **SCN** mode, [AF Mode] is fixed to **AF.S** or **AF.C** depending on the set scene. (p.88)
- In **AUTO** mode, [AF Mode] is fixed to **AFA**.

## Selecting the Focusing Area (AF Point)



- Press **INFO** in standby mode.
- Select **[AF Active Area]** and press **OK**.  
The [AF Active Area] screen appears.
- Select the desired focus point selection mode and press **OK**.

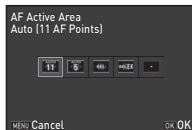

<b>Auto (11 AF Points)</b>	Out of the 11 AF points, the camera automatically selects the optimum focusing area.
<b>Auto (5 AF Points)</b>	Out of the 5 AF points, the camera automatically selects the optimum focusing area.
<b>Select</b>	Sets the focusing area to the user selected point from 11 points.
<b>Expanded Area AF</b>	Sets the focusing area to the user selected point from 11 points. When the subject happens to move out of the selected focusing area after being focused, 8 peripheral points are used as back-up points. Not available in <b>AF.S</b> mode.
<b>Spot</b>	Sets the focusing area to the center of the 11 points.

The control panel reappears.

## 4 Press **MENU**.

The camera returns to standby mode.

If you selected **MF** or **AF** in Step 3, proceed to Step 5.

## 5 Select the desired AF point.

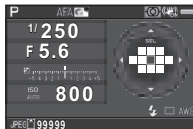

### Available operations



Changes the AF point.



Returns the AF point to the center.

Press and hold **OK**

Switches the function of the arrow keys (**▲▼◀▶**) to that for Change AF Point or the direct key operation.

### Memo

- When the AF point can be changed, the **OK** lamp turns off.
- To change the AF point from the menu, set in [AF Active Area] of [AF Settings] in the **1** menu.
- You can also set the camera so that switching to the Change AF Point mode by pressing and holding **OK** can be operated with **○**. (p.77)

## Setting the AF Mode during Live View



### 1 Press **INFO** in standby mode in Live View.



### 2 Select [Contrast AF] and press **OK**.

The [Contrast AF] screen appears.

### 3 Select an autofocus mode and press **OK**.





<b>Face Detection</b>	Detects and tracks faces of people. The main face detection frame for AF and AE is displayed in yellow.
<b>Face Detection Assist</b>	Used when facing the camera toward yourself and taking a picture.
<b>Tracking</b>	Tracks the subject in focus. The shutter can be released even if the subject is not in focus.
<b>Multiple AF Points</b>	Sets the focusing area to the desired area. The sensor is divided into 35 areas (7 horizontal by 5 vertical), and you can select a wider or narrower focusing area by using 35, 25, 15, 9, or just 1 of those 35 areas available.

 <b>Select</b>	Sets the focusing area by the pixel.
 <b>Spot</b>	Sets the focusing area to a limited area at the center.

The control panel reappears.

#### 4 Press **MENU**.

The camera returns to standby mode.

If you selected  or  in Step 3, proceed to Step 5.

#### 5 Press and hold **OK**.



#### 6 Select the AF area.

Use the frame that appears on the monitor to change the position and size of the AF area.



#### Available operations

  Changes the position of the AF area.

 Increases/reduces the size of the AF area (when  is selected).

 Returns the AF area to the center.



#### 7 Press **OK**.

The AF area is set.

#### ⚠ Caution

- When  is selected, the focus lock operation (composition adjustment with the half press of **SHUTTER**) does not work.

#### 📌 Memo

- When set to , the number of faces detected can be confirmed by the number of lit grip lamps (0 to 5).
- To change the setting from the menu, set in [Contrast AF] of [Live View] in the 3 menu.
- When [Focus Peaking] is set to [On] in the control panel or [Live View] of the 3 menu, the outline of the subject in focus is emphasized and makes it easier to check the focus. This function works in both **AF** and **MF** modes.

You can precisely fine tune your lenses with the camera's autofocus system.

**1** Select **[25 AF Fine Adjustment]** in **C4** menu and press **▶**.

The [25 AF Fine Adjustment] screen appears.

**2** Select **[Apply All]** or **[Apply One]** and press **OK**.

<b>Apply All</b>	Applies the same adjustment value to all lenses.
<b>Apply One</b>	Saves an adjustment value for the lens being used. (Up to 20 values)

**3** Select **[Setting]** and adjust the value.

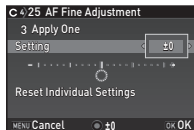

#### Available operations

<b>▶/○</b> to the right	Adjusts the focus to a closer position.
<b>◀/○</b> to the left	Adjusts the focus to a farther position.
<b>○</b>	Resets the adjustment value to the default setting.

**4** Press **OK**.

The adjustment value is saved.

**5** Press **MENU** twice.

The camera returns to standby mode.

You can choose from the following drive modes.

<b>Single Frame Shooting</b> (□)	Normal capture mode
<b>Continuous Shooting</b> (☰/☷)	Continuously takes pictures while <b>SHUTTER</b> is kept pressed. The framerate varies according to the shutter speed.
<b>Self-timer</b> (☺/☷)	Releases the shutter about 12 seconds or 2 seconds after <b>SHUTTER</b> is pressed.
<b>Remote Control</b> (Ⓜ/Ⓜas)	Enables shooting with remote control. Select from [Remote Control] or [Remote Control (3 sec. delay)].
<b>Exposure Bracketing</b> (Ⓜ)	Takes three consecutive images at different exposure levels.

#### ⚠ Caution

- There are restrictions on some drive modes when used in some capture modes or in combination with some other functions. (p.88)

#### 📌 Memo

- Only **OFF** (Remote Control Off) or **Ⓜ** can be selected in **Ⓜ** mode.
- The Drive Mode setting is saved even after the power is turned off. If [Drive Mode] is set to [Off] in [Memory] of the **📷** menu, the setting returns to Single Frame Shooting when the power is turned off. (p.81)

- The Shake Reduction function is automatically turned off when Self-timer or Remote Control is selected.
- When the drive mode that employs the self-timer or remote control is selected, exposure may be affected by the light entering through the viewfinder. In such a case, use the AE Lock function. (p.44)

## Continuous Shooting

### 1 Press **▶** in standby mode.

The Drive Mode screen appears.

### 2 Select and press **▼**.

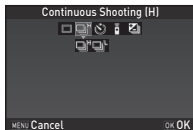

### 3 Select or and press **OK**.

The camera returns to standby mode.

### Memo

- In **AF.S** mode, the focus position is locked in the first frame.

## Self-timer

### 1 Press **▶** in standby mode.

The Drive Mode screen appears.

### 2 Select and press **▼**.

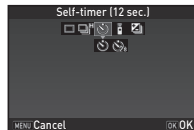

### 3 Select or and press **OK**.

The camera returns to standby mode.

### 4 Press **SHUTTER** halfway, then fully.

The grip lamps blink.

When the remaining time for the timer becomes 5 seconds or less, the number of blinking grip lamps changes in order from 5 to 0, according to the number of seconds remaining. The shutter will be released about 12 seconds or 2 seconds.



## Remote Control

- 1 Press **▶** in standby mode.  
The Drive Mode screen appears.

- 2 Select **⏏** and press **▼**.

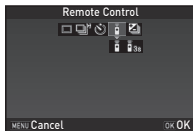

- 3 Select **⏏** or **⏏<sub>SS</sub>** and press **OK**.

The camera returns to standby mode.

The grip lamps blink.

When set to **⏏<sub>SS</sub>**, the number of blinking grip lamps changes in order from 3 to 0, according to the number of seconds remaining.

- 4 Press **SHUTTER** halfway.

- 5 Point the remote control unit towards the remote control receiver on the front of the camera, and press the shutter release button on the remote control unit.

### 📌 Memo

- The maximum operating distance of the remote control unit is approx. 4 m from the front of the camera.
- To adjust focus with remote control, set in [19 AF with Remote Control] of the **C3** menu.
- When using the Remote Control Waterproof O-RC1, the autofocus system can be operated with the **1/4** button on the remote control unit. The **Fn** button cannot be used.

## Exposure Bracketing

- 1 Press **▶** in standby mode.  
The Drive Mode screen appears.

- 2 Select **⏏** and press **▼**.

- 3 Set the bracket value.



### Available operations

	Changes the bracket value (up to ±3 EV)
	Adjusts the exposure compensation value.
	Resets the adjustment value to the default setting.

- 4 Press **OK**.

The camera returns to standby mode.

### 📌 Memo

- You can set the bracketing order in [8 Bracketing Order] of the **C2** menu.
- The bracket value can be set in increments of 1/3 EV steps or 1/2 EV steps according to the [1 EV Steps] setting made in the **C1** menu.
- Set [9 One-Push Bracketing] to [On] in the **C2** menu to shoot the specified number of images with one press of **SHUTTER**.

## Setting the White Balance



- 1 Press  $\blacktriangledown$  in standby mode.**  
The White Balance setting screen appears.

- 2 Select the White Balance.**



AWB	AWB Auto White Balance
	Multi Auto White Balance
	Daylight
	Shade
	Cloudy
	Fluorescent - Daylight Color
	Fluorescent - Daylight White
	Fluorescent - Cool White
	Fluorescent - Warm White
	Tungsten
	Flash
CTE	Color Temperature Enhancement
	Manual White Balance
K	Color Temperature

### Available operations when shooting with the viewfinder

- Uses Digital Preview to preview the background image with the white balance setting applied.
- Saves the preview image (only when the image can be saved).

Proceed to Step 5 if you do not need to fine-tune the white balance.

- 3 Press **INFO**.**  
The fine-tuning screen appears.



### Available operations

- Adjust: Green-Magenta
- Adjust: Blue-Amber
- Resets the adjustment value to the default setting.

- 4 Press **OK**.**  
The screen of Step 2 reappears.

- 5 Press **OK**.**  
The camera returns to standby mode.

- Memo**
- When is set, even if various light sources are present at the shooting location, the camera automatically adjusts the white balance according to the light source of each area.

- The following settings for the white balance can be set in the **C2** menu.

<b>10 WB Adjustable Range</b>	Fixed, Auto Adjustment
<b>11 WB When Using Flash</b>	Auto White Balance, Multi Auto White Balance, Flash, Unchanged
<b>12 AWB in Tungsten Light</b>	Strong Correction, Subtle Correction
<b>13 Color Temperature Steps</b>	Kelvin, Mired

## Adjusting the White Balance Manually

You can measure the white balance at a selected location.

- 1 Select  in Step 2 of "Setting the White Balance" (p.56).

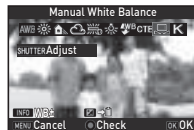

- 2 Under the light you wish to measure the white balance of, select a white area as the subject, and press **SHUTTER** fully.

The captured image is displayed.

- 3 Use **▲▼◀▶** to specify the measuring area.



- 4 Press **OK**.

The White Balance setting screen reappears.

[The operation could not be completed correctly] appears when measuring is unsuccessful. Press **OK** to remeasure the white balance and return to Step 3.

### Memo

- You can copy the white balance settings of a captured image and save them as manual white balance settings in [Save as Manual WB] of the playback mode palette. (p.64)

## Adjusting the White Balance with Color Temperature

Specify the white balance with the color temperature.



**1** Select **K** in Step 2 of "Setting the White Balance" (p.56).

**2** Press **INFO**.

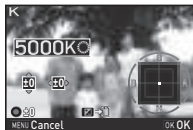
**3** Adjust the color temperature.  
Set the color temperature value within the range from 2500K to 10000K.



### Available operations

-  Changes the color temperature in increments of 100 Kelvin.
-  Fine-tunes the color temperature.

**4** Press **OK**.  
The White Balance setting screen reappears.

### Memo

- Select [Mired] in [13 Color Temperature Steps] of the **C2** menu to set the color temperature in increments of 20 Mired. However, figures are converted to and displayed in Kelvin.

## Controlling the Image Finishing Tone

When you want to take pictures with a slightly different style, you can set the desired picture style before shooting. Try out the various settings, and find your best picture style.

### Custom Image



**1** Select [Custom Image] in the control panel, and press **OK**.  
The Custom Image setting screen appears.

**2** Select an image finishing tone.

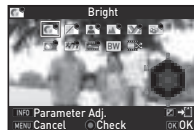

Bright  
Natural  
Portrait  
Landscape  
Vibrant  
Radiant

Muted  
Bleach Bypass  
Reversal Film  
Monochrome  
Cross Processing

### Available operations when shooting with the viewfinder

- Uses Digital Preview to preview the background image with the selected setting applied.
- ☑ Saves the preview image (only when the image can be saved).

Proceed to Step 6 if you do not need to change the parameters.

### 3 Press **INFO**.

The parameter setting screen appears.

### 4 Set the parameters.



### Available operations

- ▲▼ Selects a parameter.
- ◀▶ Adjusts the value.
- Switches between [Sharpness] and [Fine Sharpness]. (Not available in mode)
- Resets the adjustment value to the default setting.

### 5 Press **OK**.

The screen of Step 2 reappears.

### 6 Press **OK**.

The control panel reappears.

### 7 Press **MENU**.

The camera returns to standby mode.

### ⚠ Caution

- This function is not available when in **AUTO**, **SCN**, or **EFFECT** mode.

## Saving the Cross Processing Settings of a Captured Image

The outcome of Cross Processing varies each time a picture is taken. If you take a cross processed image that you like, you can save the Cross Processing settings used in the image so that you can repeatedly use the same settings.

### 1 Press ▼ in single image display of playback mode.

The playback mode palette appears.

### 2 Select and press **OK**.

The camera searches for cross processed images starting from the most recent image taken.

[No cross processed image] appears if there are no cross processed images.

### 3 Use to select a cross processed image.

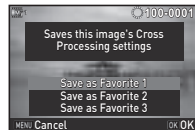

### 4 Select the "Favorite" number 1, 2 or 3 to save the settings, and press **OK**.

The settings of the selected image are saved as your "Favorite" settings.

### Memo

- The saved Cross Processing settings can be loaded by selecting [Cross Processing] in Step 2 of "Custom Image" (p.58), and selecting one of the Favorite settings 1 to 3 for the parameter.

## Digital Filter



- 1 Select [Digital Filter] in the control panel, and press **OK**.**

The Digital Filter setting screen appears.

- 2 Select a filter.**

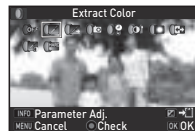

Select [No Filter] to not shoot with a digital filter.



Extract Color  
Replace Color  
Toy Camera  
Retro  
High Contrast

Shading  
Invert Color  
Unicolor Bold  
Bold Monochrome

### Available operations when shooting with the viewfinder

-  Uses Digital Preview to preview the background image with the selected effect applied.
-  Saves the preview image (only when the image can be saved).

Proceed to Step 6 if you do not need to change the parameters.

- 3 Press **INFO**.**

The parameter setting screen appears.

## 4 Set the parameters.

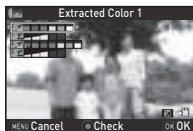

### Available operations

- ▲▼ Selects a parameter.
- ◀▶ Adjusts the value.

## 5 Press **OK**.

The screen of Step 2 reappears.





## 6 Press **OK**.

The control panel reappears.

## 7 Press **MENU**.

The camera returns to standby mode.

### ⚠ Caution

- This function cannot be used in some capture modes or in combination with some other functions. (p.88)
- [Digital Filter] of the  1 menu cannot be selected in  mode. When in  mode, set from [Digital Filter] of the  1 menu.
- Depending on the filter used, it may take longer to save images.

### 📌 Memo

- Images can also be processed with digital filters in playback mode. (p.72)

## Correcting Images

### Brightness Adjustment

### Highlight Correction/Shadow Correction



Expands the dynamic range and enables a wider range of tones to be recorded by the CMOS sensor and reduces the occurrence of overexposed/underexposed areas.

Set in the control panel or [D-Range Settings] of the  2 menu.

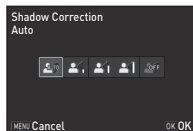

### ⚠ Caution

- When the sensitivity is set to less than ISO 200, [Highlight Correction] cannot be set to [On].

### 📌 Memo

- [Highlight Correction] in  mode can be set to [Auto] or [Off].

## HDR Capture



Takes three consecutive images at three different exposure levels to create a single composite picture with them.

Set in the control panel or [HDR Capture] of the 1 menu.

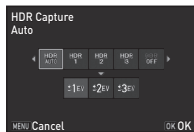

### ⚠ Caution

- This function cannot be used in some capture modes or in combination with some other functions. (p.88)
- [File Format] is fixed to [JPEG]. When [File Format] is set to [RAW] or [RAW+], the setting is changed to [JPEG].
- For HDR Capture, multiple images are combined together to create a single image, so it will take time to save the image.

### 📌 Memo

- When of the scene modes is selected, specific HDR settings are used and HDR Capture cannot be set.
- If this function was set from the 1 menu, [On] and [Off] can be selected for [Auto Align].

## Lens Correction



The following features can be set from the control panel or [Lens Correction] of the 2 menu.

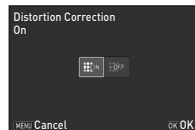

<b>Distortion Correction</b>	Reduces distortions occurring due to lens properties.
<b>Lat-Chromatic-Ab Adj</b>	Reduces lateral chromatic aberrations occurring due to lens properties.
<b>Peripheral Illumin. Corr.</b>	Reduces peripheral light fall-off occurring due to lens properties.
<b>Diffraction Correction</b>	Corrects blur caused by diffraction when narrowing the aperture.

### 📌 Memo

- Corrections can only be made when a compatible lens is attached. (p.90) The features are disabled when using an accessory such as a rear converter that is attached between the camera and the lens.
- When [File Format] is set to [RAW] or [RAW+], correction information is saved as a RAW file parameter and you can select whether to apply the correction to the images when developing them. For the RAW Development function, [Color Fringe Correction] can also be set. (p.75)



By shaking the Shake Reduction unit, a moiré reduction effect simulating that of a low-pass filter can be achieved.

Set in the control panel or [AA Filter Simulator] of the 3 menu.

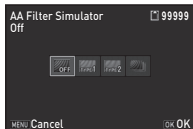



<b>Type1</b>	Takes pictures balancing the resolution and moiré reduction.
<b>Type2</b>	Prioritizes moiré reduction.
<b>Bracketing</b>	Takes consecutive images in order with [AA Filter Simulator] set to [Off], [Type1], and [Type2] (3 images are taken with one press of <b>SHUTTER</b> ).









## Caution





- This function cannot be used in the following situations.
  - When [HDR Capture] is set
  - In mode
- [Bracketing] cannot be selected in the following situations.
  - When , , or of the scene modes is selected
  - In **B** mode
  - When [Drive Mode] is set to [Continuous Shooting] or [Exposure Bracketing]
  - When the number of storable images is 2 or less

## Playback Mode Palette Items

Playback functions can be set from the playback mode palette as well as the 1 menu (p.22). Press  in single image display of the playback mode to display the playback mode palette.



Item	Function	Page
 <b>Image Rotation</b> *1	Changes the rotation information of images.	p.68
 <b>Digital Filter</b> *1	Processes images with digital filters.	p.72
 <b>Color Moiré Correction</b> *1 *2	Reduces color moiré in images.	p.71
 <b>Resize</b> *1 *2	Changes the number of recorded pixels of the image.	p.70
 <b>Cropping</b> *1	Crops out only the desired area of an image.	p.71
 <b>Protect</b>	Protects images from being accidentally erased.	p.81
 <b>Slideshow</b>	Plays back images one after another.	p.67
 <b>Save as Manual WB</b> *1	Saves the white balance settings of the captured image as Manual White Balance.	p.57

Item	Function	Page
 <b>Save Cross Processing</b>	Saves the settings used for an image captured in Cross Processing mode of Custom Image as your "Favorite" settings.	p.59
 <b>RAW Development</b> *3	Develops RAW images into JPEG images and saves them as a new file.	p.75
 <b>Movie Edit</b> *4	Divides a movie or deletes unwanted segments.	p.73
 <b>Eye-Fi Image Transfer</b> *1 *5	Transfers selected images wirelessly using an optional Eye-Fi card.	p.86

\*1 Not available when a movie is displayed.

\*2 Not available when a RAW image is displayed.

\*3 Available only when a RAW image is saved.

\*4 Available only when a movie is displayed.

\*5 Available only when an Eye-Fi card is inserted.

## Changing the Playback Method

### Displaying Multiple Images

You can display 6, 12, 20, 35 or 80 thumbnail images at the same time.

- 1 Turn  to the left in playback mode.

The multi-image display screen appears.

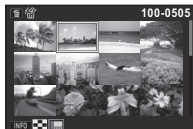

#### Available operations

 Moves the selection frame.

 Shows the display style selection screen.



 Deletes the selected images.

- 2 Press **OK**.

The selected image appears in single image display.

### Deleting Selected Images

- 1 Press  in Step 1 of "Displaying Multiple Images" (p.65).

- 2 Select the images to delete.





#### Available operations

 Moves the selection frame.

**OK** Confirms/cancels the selection of the image to delete.

 Selects the range of images to delete.

 Shows the selected image in single image display.  
Use  to select a different image.

In the upper left area of the monitor, the number of selected images is displayed.

- 3 Press .
- The delete confirmation screen appears.

- 4 Select **[Delete]** and press **OK**.

## Memo

- You can select up to 500 images at a time.
- Protected images cannot be selected.
- You can delete the images selected individually along with the images selected by specifying the range to delete.
- Use the same steps to select multiple images for the following functions.
  - RAW Development (p.75)
  - Protect (p.81)
  - Eye-Fi Image Transfer (p.86)

## Displaying Images by Folder

- 1** Turn  to the left in Step 1 of "Displaying Multiple Images" (p.65).

The folder display screen appears.



### Available operations



Moves the selection frame.



Deletes the selected folder.

- 2** Press **OK**.

The images in the selected folder are displayed.

## Deleting a Folder

- 1** Select a folder to delete in Step 1 of "Displaying Images by Folder" (p.66), and press .

The delete confirmation screen appears.

- 2** Select **[Delete]** and press **OK**.

The selected folder and all the images in it are deleted. When there are protected images in the folder, select [Delete all] or [Leave all].

## Displaying Images by Shooting Date

Images are grouped and displayed by shooting date.

- 1 Press **INFO** in Step 1 of "Displaying Multiple Images" (p.65).

The display style selection screen appears.

- 2 Select [Calendar Filmstrip Display].



Shooting date      Thumbnail date

### Available operations

▲▼	Selects a shooting date.
◀▶	Selects an image taken on the selected shooting date.
🔄 to the right	Shows the selected image in single image display.
🗑️	Deletes the selected image.

- 3 Press **OK**.

The selected image appears in single image display.

## Playing Back Images Continuously (Slideshow)

- 1 Select **🎞️** in the playback mode palette.  
Slideshow starts.

### Available operations

OK	Pauses/resumes playback.
◀	Displays the previous image.
▶	Displays the next image.
▼	Stops playback.
🔊	Adjusts the volume of the movie.

After all images are played back, the camera returns to single image display.

### 📌 Memo

- You can change the [Display Duration], [Screen Effect], [Repeat Playback] and [Auto Movie Playback] settings for slideshow in [Slideshow] of the **📷1** menu. Slideshow can be started from the Slideshow setting screen.

## Displaying Rotated Images

When you take pictures with the camera held vertically, image rotation information is saved when shooting. When [Auto Image Rotation] in the 1 menu is set to [On], the image is automatically rotated based on the rotation information during playback (default setting).

The rotation information of an image can be changed by following the procedure below.

**1 Display the image to edit in single image display.**

**2 Select  in the playback mode palette.**

The selected image is rotated in 90° increments and the four thumbnail images are displayed.

**3 Use     to select the desired rotation direction and press **OK**.**

The image rotation information is saved.

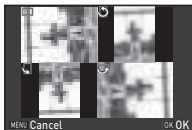

### Caution

- When [22 Save Rotation Info] is set to [Off] in the **C4** menu, image rotation information is not saved when shooting.
- You cannot change the rotation information in the following cases.
  - Protected images
  - Images without a rotation information tag
- Movie files cannot be rotated.

## Connecting the Camera to an AV Device

Connect to an AV device, such as a TV, equipped with an HDMI terminal to display Live View images while shooting or to play back images in playback mode.

Make sure to have a commercially available HDMI cable equipped with an HDMI terminal (type D).

**1 Turn the AV device and camera off.**

**2 Open the terminal cover of the camera, and connect the cable to the HDMI terminal.**

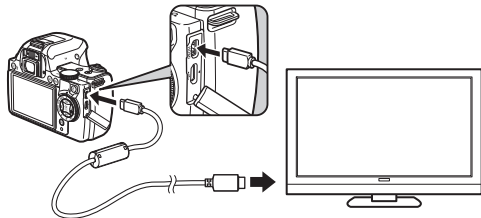

**3 Connect the other end of the cable to the input terminal on the AV device.**

**4 Turn the AV device and camera on.**

The camera turns on in HDMI mode, and the camera information is displayed on the screen of the connected AV device.

## ⚠ Caution

- While the camera is connected to an AV device, nothing is displayed on the camera monitor. Also, you cannot adjust the volume on the camera. Adjust the volume on the AV device.

## 📄 Memo

- Check the operating manual of the AV device and select a suitable input terminal for connecting the camera.
- If you intend to use the camera continuously for a long period, use of the optional AC adapter kit is recommended.
- By default, the maximum resolution supported by both the AV device and camera is automatically selected. If it fails to play back images properly, change the setting in [HDMI Out] of the  2 menu.

## Connecting the Camera to a Computer

Connect the camera to a computer using an USB cable. Make sure to have a commercially available USB cable equipped with a micro B terminal.

- 1 Turn the computer on.**
- 2 Turn the camera off.**
- 3 Open the terminal cover of the camera, and connect the USB cable to the USB terminal.**

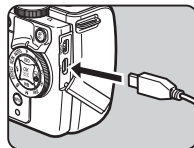

- 4 Connect the USB cable to the USB port of the computer.**

- 5 Turn the camera on.**

The camera is recognized as a removable disk.

The grip lamps of the camera blink slowly while the camera is connected with the computer via USB cable.

- 6 Save the captured images to the computer.**

- 7 Disconnect the camera from the computer.**

**⚠ Caution**

- The camera cannot be operated while it is connected to a computer. To operate the camera, terminate the USB connection on the computer, then turn off the camera and remove the USB cable.
- If the “PENTAX K-S1” dialog appears on the computer screen in Step 5, select [Open folder to view files] and click the OK button.

**📝 Memo**



- Refer to “Operating Environment for USB Connection and Provided Software” (p.104) for system requirements to connect the camera to a computer and to use the software.
- The USB connection mode when connecting the camera to a computer can be set in [USB Connection] of the **2** menu. Normally, you do not need to change the default setting ([MSC]).

**Editing and Processing Images****Changing the Image Size****⚠ Caution**

- Only JPEG images captured with this camera can be resized or cropped.
- Images already resized or cropped to the minimum file size cannot be processed.

**Changing the Number of Recorded Pixels (Resize)**

Changes the number of recorded pixels of the selected image, and saves it as a new file.

- 1 Display the image to edit in single image display.**
- 2 Select  in the playback mode palette.**  
The screen to select the number of recorded pixels appears.
- 3 Use   to select the number of recorded pixels and press **OK**.**  
You can select an image size smaller than that of the original image.  
The save confirmation screen appears.
- 4 Select [Save] and press **OK**.**

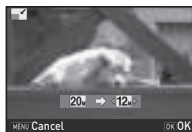







## Cropping Out Part of the Image (Cropping)

Crops out only the desired area of the selected image and saves it as a new file.

- 1 Display the image to edit in single image display.
- 2 Select  in the playback mode palette.  
The cropping frame to specify the size and position of the area to crop appears on the screen.
- 3 Specify the size and position of the area to crop by using the cropping frame.



### Available operations

- |   |   |
|---|---|
|  | Changes the size of the cropping frame.             |
|  | Moves the cropping frame.                           |
|  | Changes the aspect ratio or Image Rotation setting. |
|  | Rotates the cropping frame (only when possible).    |

- 4 Press **OK**.  
The save confirmation screen appears.
- 5 Select **[Save]** and press **OK**.

## Correcting Color Moiré

Reduces color moiré in images.

- 1 Display the image to edit in single image display.
- 2 Select  in the playback mode palette.  
If the image cannot be edited, [This image cannot be processed] appears.
- 3 Use   to select the correction level and press **OK**.  
The save confirmation screen appears.

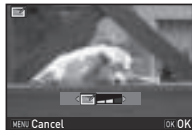

- 4 Select **[Save]** and press **OK**.

### Caution

- The Color Moiré Correction function can be used only for the JPEG images captured with this camera.

## Processing Images with Digital Filters

**1** Display the image to edit in single image display.

**2** Select **INFO** in the playback mode palette.

The screen to select a digital filter appears.

**3** Select a filter.

Use **←** to select a different image.



Base Parameter Adj

Extract Color

Replace Color

Toy Camera

Retro

High Contrast

Shading

Invert Color

Unicolor Bold

Bold Monochrome

Tone Expansion

Sketch

Water Color

Pastel

Posterization

Miniature

Soft

Starburst

Fish-eye

Slim

Monochrome

Proceed to Step 6 if you do not need to change the parameters.

**4** Press **INFO**.

The parameter setting screen appears.

**5** Set the parameters.



### Available operations

▲ ▼ Selects a parameter.

◀ ▶ Adjusts the value.

**6** Press **OK**.

The screen of Step 3 reappears.

**7** Press **OK**.

The save confirmation screen appears.

**8** Select **[Apply additional filter(s)]** or **[Save]** and press **OK**.

Select **[Apply additional filter(s)]** when you want to apply additional filters to the same image. The screen of Step 3 reappears.

### ⚠ Caution

- Only JPEG and RAW images captured with this camera can be edited with the digital filters.

### 📝 Memo

- Up to 20 filters, including the digital filter used during shooting (p.60), can be applied to the same image.

## Recreating Filter Effects

Retrieves the filter effects of the selected image and applies the same filter effects to other images.

**1** Display a filter-processed image in single image display.

**2** Select **[O]** in the playback mode palette.

**3** Select **[Recreating filter effects]** and press **OK**.

The filter effects used for the selected image appear.



**4** To check the parameter details, press **[INFO]**.

Press **[INFO]** again to return to the previous screen.

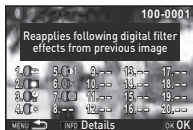

**5** Press **OK**.

The image selection screen appears.

**6** Use **[O]** to select an image for applying the same filter effects, and press **OK**.

You can only select an image that has not been processed with a filter.

The save confirmation screen appears.

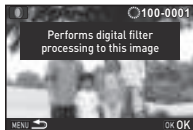

**7** Select **[Save]** and press **OK**.

### Memo

- If **[Searching for original image]** is selected in Step 3, the original image prior to digital filter application can be retrieved.

## Editing Movies

**1** Display the movie to edit in single image display.

**2** Select **[S]** in the playback mode palette.

The movie editing screen appears.

**3** Select the point where you want to divide the movie.

The frame at the dividing point is displayed at the top of the screen.

Up to four points can be selected to divide the original movie into five segments.



**Available operations**

▲	Plays back/pauses a movie.
▶	Forwards a frame (when paused).
Press and hold ▶	Fast-forwards playback.
◀	Reverses a frame (when paused).
Press and hold ◀	Fast-reverses playback.
⊙	Adjusts the volume.
INFO	Confirms/cancels a dividing point.

Proceed to Step 7 if you do not want to delete any segment.

**4 Press .**

The screen to select segments to delete is displayed.

**5 Use ◀▶ to move the selection frame and press .**

The segments to delete are specified. (Multiple segments can be deleted at once.)

Press  again to cancel the selection.

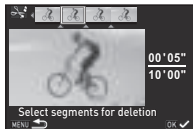
**6 Press .**

The screen of Step 3 reappears.

**7 Press .**

The save confirmation screen appears.

**8 Select [Save] and press .**** Memo**

- Select dividing points in chronological order from the beginning of the movie. When canceling the selected dividing points, cancel each of them in reverse order (from the end of the movie to the beginning). In an order other than specified, you can neither select dividing points nor cancel the selections of the dividing points.

## RAW Development

You can develop RAW images into JPEG images, and save them as a new file.

### 1 Select **RAW** in the playback mode palette.

The screen for selecting a RAW image processing option appears.

### 2 Select the desired option and press **OK**.

<b>Select single image</b>	Develops an image.
<b>Select multiple images</b>	Develops up to 500 images with the same settings.
<b>Select a folder</b>	Develops up to 500 images in the selected folder with the same settings.

When [Select single image] is selected, proceed to Step 6. The image/folder selection screen appears.

### 3 Select the image(s) or a folder.

Refer to Step 2 of “Deleting Selected Images” (p.65) for how to select the image(s).

### 4 Press **INFO**.

The screen for selecting the parameter setting method appears.

### 5 Select the parameter setting method and press **OK**.

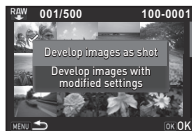

<b>Develop images as shot</b>	Allows you to change Image Capture Settings (File Format, JPEG Recorded Pixels, and JPEG Quality).
<b>Develop Images with modified settings</b>	Allows you to change Image Capture Settings (File Format, Aspect Ratio, JPEG Recorded Pixels, JPEG Quality, Color Space), Lens Correction (Distortion Correction, Lat-Chromatic-Ab Adj, Peripheral Illumin. Corr., Diffraction Correction, Color Fringe Correction), Digital Filter, White Balance, Custom Image, Sensitivity, High-ISO NR, and Shadow Correction.

### 6 Set the parameters.

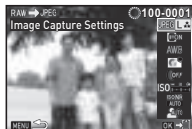

#### Available operations

▲▼ Selects a parameter.

◀▶ Changes the value.

○ Selects a different image (when in single image display).

For Image Capture Settings and Lens Correction, press ▶ and use ▲▼ to select an item.

For Digital Filter, White Balance and Custom Image, press ▶ to display the setting screen.

## 7 Press **OK**.

The save confirmation screen appears.

## 8 Select **[Save]** and press **OK**.

When **[Select single image]** is selected, select **[Continue]** or **[Exit]**, and press **OK**.

### **Caution**



- Only RAW images captured with this camera can be developed.
- If the White Balance, Custom Image or Digital Filter settings of RAW images captured in **EFFECT** mode are modified before developing, the information about the applied effects mode is deleted. In such a case, the capture mode is displayed as **P** in Detailed Information Display of the playback mode.

### **Memo**

- When **[Select multiple images]** or **[Select a folder]** is selected in Step 2, a folder with a new number is created, and the JPEG images are stored in it.
- With the provided software "Digital Camera Utility 5", you can develop RAW files on a computer.

# Camera Settings

## Customizing the Button/E-dial Functions 4

You can set the functions for when **AF/AE-L** or  is pressed or when  is turned.

### 1 Select [Button Customization] in 4 menu and press .

The [Button Customization] screen appears.

### 2 Select the desired item and press .

The screen to set the function for the selected item is displayed.

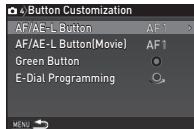

### 3 Select a function and press **OK**.

The following functions can be assigned to each button.

	Setting	Function	Page
<b>AF/AE-L Button</b> <b>AF/AE-L Button (Movie)</b>	<b>Enable AF1</b>	Autofocus is performed when <b>AF/AE-L</b> is pressed.	p.49
	<b>Enable AF2</b>	Autofocus is performed when <b>AF/AE-L</b> is pressed and not when <b>SHUTTER</b> is pressed halfway.	
	<b>Cancel AF</b>	While <b>AF/AE-L</b> is pressed, the autofocus mode is set to <b>MF</b> even when <b>SHUTTER</b> is pressed halfway.	
	<b>AE Lock</b>	Locks the exposure setting.	p.44

	Setting	Function	Page
Green Button	<b>Green Button</b>	Resets the value being adjusted.	-
	<b>One Push File Format</b>	Temporarily changes the file format.	p.78
	<b>Optical Preview</b>	Activates the Optical Preview to check the depth of field with the viewfinder.	p.43
	<b>Digital Preview</b>	Activates the Digital Preview to check the composition, exposure and focus on the monitor. (The maximum display time: 60 seconds) You can magnify or save the preview image.	
E-Dial Programming	<b>AF Active Area</b>	Enables changing the AF point.	p.51
	<b>Rotate Right</b>	Increases values when  is turned to the right (toward ).	-
	<b>Rotate Left</b>	Increases values when  is turned to the left (toward ).	

#### 4 Press **MENU**.

The [Button Customization] screen reappears.  
Repeat Steps 2 to 4.

#### 5 Press **MENU** twice.

### Setting the One Push File Format

1 Set [**Green Button**] to [**One Push File Format**] in Step 3 of "Customizing the Button/E-dial Functions" (p.77).

2 Select  or  for [**Cancel after 1 shot**].

<input checked="" type="checkbox"/>	The recording format returns to the original file format after a picture is taken.
<input type="checkbox"/>	The setting is retained until any of the following operations is performed: <ul style="list-style-type: none"> <li>• When  is pressed again</li> <li>• When  or <b>MENU</b> is pressed, or when the mode dial or main switch is turned</li> </ul>

3 For each file format, select the file format for when is pressed.

The left side is the [File Format] setting and the right side is the changed file format when is pressed.

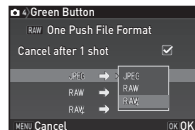





## Setting the E-dial Operation in P Mode

Set the value to be changed with  when in **P** mode.

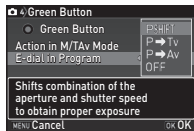
- 1 Set [Green Button] to [Green Button] in Step 3 of "Customizing the Button/E-dial Functions" (p.77).
- 2 Press  and select [E-dial in Program], and change the setting.



<b>P SHIFT</b>	Automatically adjusts the shutter speed and aperture value to obtain a proper exposure (Program Shift).
<b>P → Tv</b>	Adjusts the shutter speed (Shutter Priority Automatic Exposure).
<b>P → Av</b>	Adjusts the aperture value (Aperture Priority Automatic Exposure).
<b>OFF</b>	Disables the  operation when turned in <b>P</b> mode.

### Memo

- If  is pressed after turning  in **P** mode, the setting returns to normal **P** mode.

## Setting the Green Button Operation in M/TAv Mode

You can set the function of  when in **M** or **TAv** mode.

- 1 Set [Green Button] to [Green Button] in Step 3 of "Customizing the Button/E-dial Functions" (p.77).
- 2 Press  and select [Action in M/TAv Mode], and change the setting.

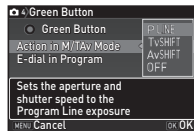

<b>P LINE</b>	Adjusts the aperture value and shutter speed to obtain a proper exposure according to the program line.
<b>Tv SHIFT</b>	Adjusts the shutter speed while the aperture value remains fixed.
<b>Av SHIFT</b>	Adjusts the aperture value while the shutter speed remains fixed.
<b>OFF</b>	Disables the  operation when pressed in <b>M</b> or <b>TAv</b> mode.

## Selecting the Display Settings for Digital Preview

- 1 Set [Green Button] to [Digital Preview] in Step 3 of "Customizing the Button/E-dial Functions" (p.77).
- 2 Press ▼ and select  or  for each display item.

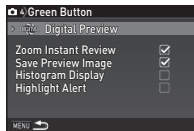

## Displaying the Local Date and Time of the Specified City

1

The date and time set at the time of initial setting (p.32) serve as the date and time of your present location and are reflected in the shooting date and time for images.

Setting the destination to a location other than your present location enables you to display the local date and time on the monitor when traveling abroad and also save images time-stamped with the local date and time.

- 1 Select [World Time] in 1 menu.

The [World Time] screen appears.

- 2 Select the time you wish to display in [Time Setting].

Select (Hometown)  
or (Destination).

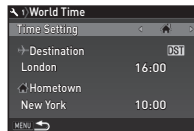

- 3 Select [ Destination] and press ►.

The [ Destination] screen appears.

- 4 Use to select a city.

Use to change the region.

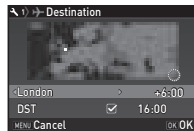



- 5 Select [DST] (daylight saving time), and use to select  or .

## 6 Press **OK**.

The [World Time] screen reappears.

### Memo

- Refer to “List of World Time Cities” (p.103) for cities that can be selected as a hometown or destination.
- Select [ Hometown] in Step 3 to change the city and DST settings for the hometown.
-  appears in the control panel when [Time Setting] is set to .

## Selecting Settings to Save in the Camera

Most of the functions set on this camera are saved even if the camera is turned off. For the following function settings, you can select whether to save the settings () or to return the settings to their default values () when the camera is turned off. The default settings are  for Digital Filter, HDR Capture and Shooting Info Display, and  for the other functions. Set in [Memory] of the 4 menu.

Flash Mode	Flash Exposure
Drive Mode	Compensation
White Balance	Digital Filter
Custom Image	HDR Capture
Sensitivity	Shooting Info Display
EV Compensation	Playback Info Display

### Memo

- When [Reset] of the 3 menu is performed, all Memory settings return to the default values.

## File Management Settings

### Protecting Images from Deletion (Protect)

You can protect images from being accidentally deleted.

#### Caution

- Even protected images are deleted if the inserted memory card is formatted.

#### 1 Select **Protect** in the playback mode palette.

The screen for selecting the unit for processing appears.

#### 2 Select [Select image(s)] or [Select a folder] and press **OK**.

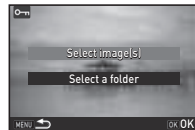

#### 3 Select the image(s) or folder to protect.

Refer to Step 2 of “Deleting Selected Images” (p.65) for how to select the image(s).

Proceed to Step 5 if [Select a folder] is selected.

#### 4 Press **INFO**.

The confirmation screen appears.

#### 5 Select [Protect] and press **OK**.

## Memo

- To protect all images stored in the memory card, select [Protect All Images] of the 1 menu.

## Selecting the Folder/File Settings

### Folder Name

When images are captured with this camera, a folder is automatically created and the captured images are stored in it. Each folder name consists of a sequential number from 100 to 999 and a string of 5 characters.

The folder name can be changed.

- 1 Select [Folder Name] in 2 menu and press .**

The [Folder Name] screen appears.

- 2 Select a folder name and press .**

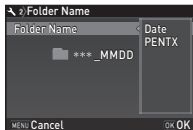

Text selection cursor



Text input cursor

<b>Date</b>	The two digits of the month and day on which the picture was taken are assigned after the folder number. The month and day appear according to the date format set in [Date Adjustment]. Example) 101_0125: for images taken on January 25th
<b>PENTX</b>	The character string "PENTX" is assigned after the folder number. The character string can be changed arbitrarily. Example) 101PENTX

Proceed to Step 6 if you do not need to change the character string from "PENTX".

- 3 Press , and then press .**

The text-entry screen appears.

- 4 Change the text.**

Enter 5 single-byte alphanumeric characters.

### Available operations



Moves the text selection cursor.



Moves the text input cursor.



Resets the entered text to "PENTX".



Enters a character selected with the text selection cursor at the position of the text input cursor.

## 5 After entering the text, move the text selection cursor to [Finish], and press **OK**.

The screen of Step 2 reappears.

## 6 Press **MENU** twice.

### **Memo**

- A folder with a new number is created when the folder name is changed.
- A maximum of 500 images (100 images for Eye-Fi card) can be stored in a single folder. When the number of captured images exceeds 500, a new folder is created with the number following the number of the folder currently being used. In Exposure Bracketing shooting, images will be stored in the same folder until shooting is completed.
- When [Create New Folder] is selected in the **2** menu, a folder is created with a new number when the next image is saved.
- When [Select multiple images] or [Select a folder] of [RAW Development] is selected, a folder with a new number is created, and the JPEG images are stored in it. (p.75)

### **Caution**

- The maximum folder number is 999. After the folder number reaches 999, you cannot capture new images if you attempt to change the folder name or create a new folder, or when the file name number reaches 9999.

## File Name

One of the following string of characters is used as the file name prefix depending on the [21 Color Space] setting of the **C3** menu.

Color Space	File Name
sRGB	IMG Pxxxx.JPG
AdobeRGB	_IMGxxxx.JPG

The first four characters can be changed to a character string of your choice.

## 1 Select [File Name] in **2** menu and press **▶**.

The [File Name] screen appears.

## 2 Select **📷** or **📹** and press **▶**.

The text-entry screen appears.



## 3 Change the text.

Up to 4 single-byte alphanumeric characters can be entered.

Refer to Steps 4 and 5 of "Folder Name" (p.82) for how to enter text.

## 4 Press **MENU** twice.

**Memo**

- When [Color Space] is [AdobeRGB], the file name prefix is “\_” and first three characters of the entered character string becomes the file name.
- For movies, regardless of the [Color Space] setting, the file name is “IMGPxxxx.MOV” or the one with the entered string of characters.

**File No.**

Each file name consists of a string of 4 characters and a sequential number from 0001 to 9999.

You can set whether to continue the sequential numbering for the file name even if a new folder is created in [Sequential Numbering] of [File No.] in the 2 menu.

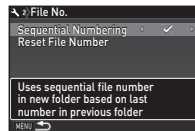

<input checked="" type="checkbox"/>	Continues the sequential numbering for the file name even if a new folder is created.
<input type="checkbox"/>	Returns the file number of the first image saved to a folder to 0001 each time a new folder is created.

Select [Reset File Number] to reset the file number to its default value.

**Memo**

- When the file number reaches 9999, a new folder is created and the file number is reset.

## Setting the Copyright Information

2

Sets the photographer and copyright information embedded in the Exif data.

### 1 Select [Copyright Information] in 2 menu and press ►.

The [Copyright Information] screen appears.

### 2 Use ◀▶ to set [Embed Copyright Data].



<input type="checkbox"/>	Does not embed copyright information in the Exif data.
<input checked="" type="checkbox"/>	Embeds copyright information in the Exif data.

### 3 Select [Photographer] or [Copyright Holder], and press ►.

The text-entry screen appears.

### 4 Change the text.

Up to 32 single-byte alphanumeric characters and symbols can be entered.

Text selection cursor

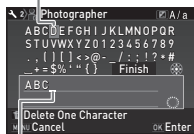

Text input cursor

## Available operations



Moves the text selection cursor.



Moves the text input cursor.



Switches between upper and lower case letters.



Deletes a character at the position of the text input cursor.



Enters a character selected with the text selection cursor at the position of the text input cursor.

### 5 After entering the text, move the text selection cursor to [Finish], and press OK.

The screen of Step 2 reappears.

### 6 Press MENU twice.

#### Memo

- The Exif information can be checked using the provided software "Digital Camera Utility 5".

## Using a Wireless Memory Card

↶ 3

A memory card with a built-in wireless LAN "Eye-Fi card" (Wi-Fi transmission) or a "Flucard" compatible with this camera can be used. By using these cards, images can be transferred from the camera to a computer or other device via wireless LAN. Select the camera action when using an Eye-Fi card or a Flucard.

### 1 Select [Wireless Memory Card] in ↶ 3 menu and press ►.

The [Wireless Memory Card] screen appears.

### 2 Select [Action Mode].

The items that can be set are displayed according to the type of card inserted.

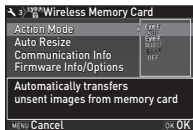

#### Eye-Fi card

<b>AUTO</b>	Transfers images automatically when there are any images that have not yet been transferred. Only movies with a size of 2 GB or less can be transferred.
<b>SELECT</b>	Transfers images or folders that are selected in [Eye-Fi Image Transfer] of the playback mode. (p.64) Only JPEG and RAW images can be transferred.
<b>OFF</b>	Stops the communication function.

#### Flucard

<b>ON</b>	Enables wireless data transfer with Flucard.
<b>OFF</b>	Disables wireless data transfer with Flucard.

### 3 Select or for [Auto Resize].

When set to , JPEG images are saved to the Eye-Fi card or Flucard at the size of **XS**.

### 4 Press **MENU** twice.

#### ⚠ Caution

- When an Eye-Fi card or a Flucard is not inserted, the camera action cannot be set.
- Set up a wireless LAN access point on a computer for the card connection.
- When using a Flucard, update it to the latest firmware before use.
- For RAW images, the success of transfer depends on the specifications and settings of the Eye-Fi card in use.
- Images may not be transferred when the battery level is low.
- It may take time to transfer a large number of images. The camera may turn off if the internal temperature of the camera becomes high.
- For precautions on the Eye-Fi card, refer to "About Eye-Fi Cards" (p.112).



## Memo

- A smartphone can be used to operate this camera when a Flucard compatible with this camera is inserted. Refer to the Flucard manual for details on how to use the card.
- When an Eye-Fi card is used, 100 images can be stored in a single folder. For RAW+ images, two files are counted as one image.
- In Step 2, select [Communication Info] to check the Wireless LAN information, and [Firmware Info/Options] to check the firmware version of the cards.
- When [Reset Transfer Settings] is selected in Step 2, the [Action Mode] setting is returned to their default value.

# Restrictions on Each Capture Mode

x: Not available

Capture Mode		AUTO	SCN							EFFECT	B
Function											
Sensitivity						x	x		x		*1
Flash					x	x			x		
Drive Mode	Continuous Shooting					x					x
	Self-timer			x					x		
	Remote Control			x					x		
	Exposure Bracketing			x		x			x		x
Focus Method		A.F.A. <sup>*2</sup>	A.F.S. <sup>*2</sup>	A.F.S. <sup>*2</sup>	A.F.C. <sup>*2</sup>	A.F.S. <sup>*2</sup>	A.F.S. <sup>*2</sup>	A.F.C. <sup>*2</sup>	A.F.C. <sup>*2</sup>	A.F.C. <sup>*2</sup>	
File Format	RAW/RAW+					x					
	Shake Reduction					x					x
White Balance		x <sup>*3</sup>	x <sup>*3</sup>	x <sup>*3</sup>	x <sup>*3</sup>	x <sup>*3</sup>	x <sup>*3</sup>	x <sup>*3</sup>	x <sup>*3</sup>	x <sup>*3</sup>	x <sup>*3</sup>
Custom Image		x <sup>*3</sup>	x <sup>*3</sup>	x <sup>*3</sup>	x <sup>*3</sup>	x <sup>*3</sup>	x <sup>*3</sup>	x <sup>*3</sup>	x <sup>*3</sup>	x <sup>*3</sup>	

Capture Mode Function	AUTO	SCN								EFFECT	B
Digital Filter						×				×	
HDR Capture				×		*4		×		×	×
AA Filter Simulator				*5		×		*5			
Save RAW Data				×				×			

\*1 [ISO AUTO] is not available.

\*2 Fixed to; the setting cannot be changed.

\*3 Fixed to a specific setting; the setting cannot be changed.

\*4 Specific settings are used.

\*5 [Bracketing] is not available.

## Restrictions on the Combinations of Special Functions

×: Not available

		Drive Mode				HDR Capture
		Continuous Shooting	Self-timer	Remote Control	Exposure Bracketing	
Flash						×
File Format	RAW/RAW+					×
Shake Reduction			×	×		
Digital Filter						×
AA Filter Simulator		*1			*1	×
Save RAW Data		×				

\*1 [Bracketing] is not available.

## Functions Available with Various Lenses

All capture modes are available when a DA, DA L, or FA J lens is used, or when a lens with an **A** position is used with the aperture ring set to the **A** position.

When other lenses than above are used, or a lens with **A** position is used in a position other than **A**, the following restrictions apply.

✓: Available #: Restricted x: Not available

Function	Lens [Mount type]	DA DA L D FA	FA J FA <sup>*6</sup>	F <sup>*6</sup>	A	M P
		[KAF] [KAF2] [KAF3]	[KAF] [KAF2]	[KAF]	[KA]	[K]
Autofocus (Lens only) (With AF adapter 1.7x) <sup>*1</sup>		✓ -	✓ -	✓ -	- #	- #
Manual focus (With focus indicator) <sup>*2</sup> (With matte field)		✓	✓	✓	✓	✓
Quick-shift focus		# <sup>*4</sup>	x	x	x	x
Focus point selection mode [Auto]		✓	✓	✓	# <sup>*8</sup>	x
AE Metering [Multi-segment]		✓	✓	✓	✓	x
<b>P/Sv/Tv/Av/TAv</b> mode		✓	✓	✓	✓	# <sup>*9</sup>
<b>M</b> mode		✓	✓	✓	✓	#
P-TTL auto flash <sup>*3</sup>		✓	✓	✓	✓	x
Automatically obtaining the lens focal length information		✓	✓	✓	x	x
Lens Correction		✓ <sup>*5</sup>	x <sup>*7</sup>	x	x	x

- \*1 Lenses with a maximum aperture of F2.8 or faster. Only available at the **A** position.
- \*2 Lenses with a maximum aperture of F5.6 or faster.
- \*3 Available when using the built-in flash, AF540FGZ, AF540FGZ II, AF360FGZ, AF360FGZ II, AF200FG or AF160FC.
- \*4 Only available with compatible lenses.
- \*5 Distortion Correction and Peripheral Illumination Correction are disabled when a DA FISH-EYE 10-17mm lens is used.
- \*6 To use an FA SOFT 28mm F2.8 lens, FA SOFT 85mm F2.8 lens, or F SOFT 85mm F2.8 lens, set [26 Using Aperture Ring] to [Enable] in the **C4** menu. Pictures can be taken with the aperture you set, but only within a manual aperture range.
- \*7 Only available with an FA 31mm F1.8 Limited, FA 43mm F1.9 Limited, or FA 77mm F1.8 Limited lens.
- \*8 Fixed to [Spot].
- \*9 **Av** with the aperture set to wide open. (The aperture ring has no effect on the actual aperture value.)

### ⚠ Caution

- When the aperture ring is set to a position other than **A** or a lens without an **A** position or accessories such as an auto extension tube or auto bellows are used, the camera does not operate unless [26 Using Aperture Ring] is set to [Enable] in the **C4** menu. Refer to "Using the Aperture Ring" (p.92) for details.

### Lens Names and Mount Names

DA lenses with a motor and FA zoom lenses with power zoom use the KAF2 mount. DA lenses with a motor and no AF coupler use the KAF3 mount.

FA single focal length lenses (non-zoom lenses), DA or DA L lenses without a motor, and D FA, FA J and F lenses use the KAF mount.

Refer to respective lens manuals for details.

## Compatibility with the Built-in Flash

Depending on the lens being used, the use of the built-in flash may be limited.

Lens	Restrictions when using the built-in flash
<b>DA FISH-EYE 10-17mm F3.5-4.5 ED (IF)/</b> <b>DA 12-24mm F4 ED AL/</b> <b>DA 14mm F2.8 ED (IF)/</b> <b>DA 15mm F4 ED AL/</b> <b>FA* 300mm F2.8 ED (IF)/</b> <b>DA* 560mm F5.6 ED AW/</b> <b>FA* 600mm F4 ED (IF)/</b> <b>FA* 250-600mm F5.6 ED (IF)</b>	The built-in flash is not available due to vignetting.
<b>F FISH-EYE 17-28mm F3.5-4.5</b>	Vignetting may occur if the focal length is less than 20 mm.
<b>DA 16-45mm F4 ED AL</b>	When the focal length is less than 28 mm, or when the focal length is 28 mm and the shooting distance is 1 m or less, vignetting may occur.
<b>DA* 16-50mm F2.8 ED AL (IF) SDM</b>	When the focal length is 20 mm or less or when the focal length is 35 mm and the shooting distance is less than 1.5 m, vignetting may occur.

Lens	Restrictions when using the built-in flash
<b>DA 17-70mm F4 AL (IF) SDM</b>	When the focal length is less than 24 mm or when the focal length is 35 mm and the shooting distance is 1 m or less, vignetting may occur.
<b>DA 18-250mm F3.5-6.3 ED AL (IF)</b>	Vignetting may occur if the focal length is less than 35 mm.
<b>DA 18-270mm F3.5-6.3 ED SDM</b>	Vignetting may occur if the focal length is less than 24 mm.
<b>FA* 28-70mm F2.8 AL</b>	Vignetting may occur if the focal length is 28 mm and the shooting distance is less than 1 m.
<b>FA SOFT 28mm F2.8/</b> <b>FA SOFT 85mm F2.8</b>	The built-in flash always discharges fully.

## Setting the Focal Length



The Shake Reduction function operates by obtaining lens information such as focal length. Set the focal length when using a lens that the focal length information cannot be automatically obtained.

- 1** Set [26 Using Aperture Ring] to [Enable] in the C4 menu.
- 2** Turn the camera off.
- 3** Attach a lens to the camera and turn the camera on.  
The [Input Focal Length] screen appears.

#### 4 Use ▲▼ to set the focal length.

Press ◀ to select a value from the list.

When using a zoom lens, select the actual focal length to be used for shooting.

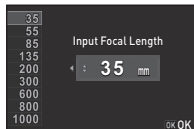

#### 5 Press OK.

The camera returns to standby mode.

#### Memo

- The focal length setting can be changed in [Input Focal Length] of the **C3** menu.
- When using a lens without an **A** position or a lens with an **A** position with the aperture ring set to a position other than **A**, set [26 Using Aperture Ring] to [Enable] in the **C4** menu. (p.92)

### Using the Aperture Ring

**C4**

The shutter can be released even if the aperture ring of the D FA, FA, F or A lens is not set to the **A** position or a lens without an **A** position is attached.

Select [Enable] in [26 Using Aperture Ring] of the **C4** menu.

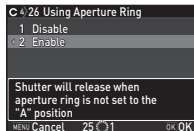

The following restrictions apply depending on the lens being used.

Lens Used	Capture Mode	Restriction
D FA, FA, F, A, M (lens only or with automatic diaphragm accessories such as auto extension tube K)	<b>Av</b>	The aperture remains open. The shutter speed changes in relation to the open aperture but an exposure deviation may occur.
D FA, FA, F, A, M, S (with diaphragm accessories such as extension tube K)	<b>Av</b>	Pictures can be taken with a set aperture value but an exposure deviation may occur.
Manual diaphragm lens such as reflex lens (lens only)	<b>Av</b>	
FA SOFT 28mm/ FA SOFT 85mm/ F SOFT 85mm (lens only)	<b>Av</b>	Pictures can be taken with a set aperture value in the manual aperture range.

#### Memo

- If the aperture ring is set to a position other than **A**, the camera operates in **Av** mode regardless of the mode dial setting except when set to **M** or **B** mode.
- [F--] appears for the aperture indicator in the status screen, Live View screen and viewfinder.

## Functions when Using an External Flash

Using an optional external flash AF540FGZ, AF540FGZ II, AF360FGZ, AF360FGZ II, AF200FG or AF160FC enables a variety of flash modes, such as P-TTL auto flash mode.

✓: Available #: Restricted X: Not available

Camera Function \ Flash	Built-in Flash	AF540FGZ AF540FGZ II AF360FGZ AF360FGZ II	AF200FG AF160FC
Red-eye reduction flash	✓	✓	✓
Auto Flash Discharge	✓	✓	✓
Automatic switch to the flash sync speed	✓	✓	✓
Automatic setting of the aperture value in <b>P</b> or <b>Tv</b> mode	✓	✓	✓
P-TTL auto flash	✓ <sup>*1</sup>	✓ <sup>*1</sup>	✓ <sup>*1</sup>
Slow-speed Sync flash	✓	✓	✓
Flash Exposure Compensation	✓	✓	✓
AF assist light of external flash	X	✓	X
Trailing Curtain Sync flash <sup>*2</sup>	✓	✓	X
Contrast-control-sync flash	# <sup>*3</sup>	✓	# <sup>*4</sup>
Slave flash	X	✓	X
High-speed Sync flash	X	✓	X

- \*1 Available only when using a DA, DA L, D FA, FA J, FA, F or A lens.
- \*2 Shutter speed of 1/90 seconds or slower.
- \*3 When combined with the AF540FGZ, AF540FGZ II, AF360FGZ, or AF360FGZ II, 1/3 of the flash discharge can be output by the built-in flash and 2/3 can be output by the external flash.
- \*4 Available only when combined with the AF540FGZ, AF540FGZ II, AF360FGZ, or AF360FGZ II.

### ⚠ Caution

- Never press **[Q]** on the camera when any external flash unit is attached to the camera. The built-in flash will hit the external flash. If you want to use both at once, connect them using an extension cord.
- Flashes with the reversed polarity (the center contact on the hot shoe is minus) cannot be used due to the risk of damaging the camera and/or flash.
- Do not combine with accessories that have a different number of contacts, such as a Hot Shoe Grip, as a malfunction may occur.
- Combining with flashes from other manufacturers may cause equipment breakdown.

### 📌 Memo

- With the AF540FGZ, AF540FGZ II, AF360FGZ, or AF360FGZ II, you can use the high-speed sync flash to discharge the flash and take a picture at a shutter speed faster than 1/180 seconds. Select a capture mode (such as **Tv**) which allows you to set the shutter speed.

## Using the GPS Unit

The following functions are available when the optional GPS unit O-GPS1 is attached to this camera.

<b>Electronic Compass</b>	Displays the current latitude, longitude, altitude, direction, Coordinated Universal Time (UTC), capture mode, and exposure value.	
<b>ASTROTRACER</b>	Tracks and captures celestial bodies. By matching the movement of the camera's built-in Shake Reduction unit with the movement of celestial bodies, celestial bodies can be captured as individual points even when shooting with a long exposure setting. (p.94)	
<b>GPS Time Sync</b>	Automatically adjusts the camera's date and time settings using information acquired from GPS satellites.	

### ● Memo



- Refer to the manual of the GPS unit for details on how to attach the unit and information on the unit's functions.
- To display [Electronic Compass], refer to "Shooting Info Display" (p.12).

### ● Caution

- "Simple Navigation" cannot be used with this camera.

## Shooting Celestial Bodies (ASTROTRACER)



- 1 Set the mode dial to B.**
- 2 Select [GPS] in 2 menu and press **▶**.**  
The [GPS] screen appears.
- 3 Select [ASTROTRACER] and press **▶**.**  
The [ASTROTRACER] screen appears.
- 4 Set [Action in B Mode] to  and press **OK**.**

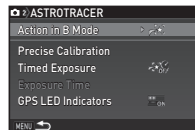

- 5 To set the desired exposure time, first set [Timed Exposure] to [ON].**  
You can set the exposure time between 0'10" and 5'00" in [Exposure Time].
- 6 Press **MENU** three times.**  
The camera returns to standby mode.
- 7 Press **SHUTTER** fully.**  
Shooting starts.
- 8 Press **SHUTTER** fully again.**  
Shooting stops.  
When [Timed Exposure] is enabled, shooting ends automatically after the set time has elapsed.















# Troubleshooting

## Memo

- In rare cases, the camera may not operate correctly due to static electricity. This can be remedied by taking the battery out and putting it back in again. If the camera operates correctly, it does not require any repairs.

Problem	Cause	Remedy
The camera does not turn on.	Battery is not installed properly.	Check the orientation of the battery.
	The battery power is low.	Charge the battery.
The shutter cannot be released.	The built-in flash is being charged.	Wait until charging is finished.
	There is no available space on the memory card.	Insert a memory card with available space or delete unwanted images.
	Data is being processed.	Wait until processing is finished.
	The lens aperture ring is set to a position other than <b>A</b> .	Set the lens aperture ring to the <b>A</b> position or select [Enable] in [26 Using Aperture Ring] of the <b>C4</b> menu. (p.92)
Autofocus does not work.	The subject is difficult to focus on.	<b>AF</b> cannot work well for low-contrast objects (the sky, white walls, etc.), dark colors, intricate designs, rapidly-moving objects or scenery shot through a window or a net-like pattern. Lock focus on another object located at the same distance as your subject, then aim at the target and take a picture. Alternatively, use <b>MF</b> .
	The subject is too close.	Move away from the subject and take a picture.

Problem	Cause	Remedy
The focus cannot be locked.	AF Mode of Live View is set to  .	Set [Contrast AF] to  ,  ,  ,  or  . (p.51)
The built-in flash does not discharge.	The flash mode is set to  or  .	When the flash mode is set to  or  , the flash does not discharge if the subject is bright. Change the flash mode. (p.47)
The camera is not recognized when it is connected to a computer.	The USB connection mode is set to [PTP].	Set [USB Connection] to [MSC] in the  2 menu.
Dust or dirt particles appear in images.	The CMOS sensor is dirty or dusty.	Activate [Dust Removal] from the  4 menu. The Dust Removal function can be activated every time the camera is turned on and off. Refer to "Sensor Cleaning" (p.96) if the problem persists.
There are visible defects in a captured image, or parts in the display monitor that do not light up or remain lit.	There are defective pixels in the CMOS sensor.	Activate [Pixel Mapping] from the  4 menu. It takes about 30 seconds to correct the defective pixels, so be sure to install a fully charged battery.

## Sensor Cleaning

↖ 4

Raise the mirror up and open the shutter when cleaning the CMOS sensor with a blower.

- 1 Turn the camera off and remove the lens.**
- 2 Turn the camera on.**
- 3 Select [Sensor Cleaning] in ↖ 4 menu and press ►.**  
The [Sensor Cleaning] screen appears.
- 4 Select [Mirror Up] and press **OK**.**  
The mirror pops up and the grip lamps blink.
- 5 Clean the CMOS sensor with a blower.**
- 6 Turn the camera off.**  
The mirror automatically returns to its original position.

### ⚠ Caution

- Never use a spray blower or a blower with a brush.  
The CMOS sensor may be damaged. Do not wipe the CMOS sensor with a cloth.
- Do not put the tip of the blower inside the lens mount area.  
If the power is turned off, this may cause damage to the shutter, CMOS sensor and the mirror.
- When the battery level is low, the message [Not enough battery power remaining to clean sensor] is displayed on the monitor. Install a fully charged battery. If the battery capacity becomes low during cleaning, a warning beep will sound.  
In this case, stop cleaning immediately.

### 📌 Memo

- Please contact your nearest service center for professional cleaning as the CMOS sensor is a precision part.
- You can use the optional Image Sensor Cleaning Kit O-ICK1 when cleaning the CMOS sensor.

## Error Messages

Error Messages	Description
Memory card full	The memory card is full and no more images can be saved. Insert a new memory card or delete unwanted files.
No image	There are no images that can be played back on the memory card.
This image cannot be displayed	You are trying to play back an image in a format not supported by this camera. You may be able to play it back on a computer.
No card in the camera	There is no memory card inserted in the camera.
Memory card error	The memory card has a problem, and image capture and playback are impossible. You may be able to play it back on a computer.
	Failed to initialize the Eye-Fi function when using the Eye-Fi card. Press <b>OK</b> .
Card is not formatted	The memory card you have inserted is unformatted or has been previously used on another device and is not compatible with this camera. Use the card after formatting it with this camera.
Card is locked	The write-protect switch on the memory card you have inserted is locked. (p.112)
This image cannot be magnified	You are trying to magnify an image that cannot be magnified.
This image is protected	You are trying to delete an image that is protected. Remove protection from the image. (p.81)

Error Messages	Description
Not enough battery power remaining to activate Pixel Mapping	These messages appear when you try to perform Pixel Mapping or Sensor Cleaning, or to update the firmware if the battery level is insufficient. Install a fully charged battery.
Not enough battery power remaining to clean sensor	
Not enough battery power remaining to update the firmware	
Unable to update firmware. There is a problem with the firmware update file	Unable to update the firmware. The update file is damaged. Try downloading the update file again.
Image folder cannot be created	The maximum folder number (999) is being used, and no more images can be saved. Insert a new memory card or format the card.
Unable to store image	The image could not be saved because of a memory card error.
The operation could not be completed correctly	The camera was unable to adjust the manual white balance. Try the operation again.
	Failed to authenticate the wireless function when using the Flucard. Or, [Reset Transfer Settings] failed when using an Eye-Fi card or Flucard.
No more images can be selected	You are trying to select more than the maximum number of images for the following functions. <ul style="list-style-type: none"> <li>• Select &amp; Delete</li> <li>• RAW Development</li> <li>• Protect</li> <li>• Eye-Fi Image Transfer</li> </ul>

Error Messages	Description
No image can be processed	There are no images that can be processed using the Digital Filter or RAW Development function.
This image cannot be processed	Appears when you try to perform Resize, Cropping, Digital Filter, Movie Edit, RAW Development, or Save as Manual WB for images captured with other cameras, or when you try to perform Resize or Cropping for minimum file size images.
This function is not available in the current mode	You are trying to set a function that is not available for the capture mode that is set.
The camera will turn off to prevent damage from overheating	The camera will turn off because its internal temperature is too high. Leave the camera turned off until it has had time to cool down before turning on the camera again.
Set the Eye-Fi communication to "SELECT"	Images cannot be transferred when [Action Mode] is not set to [SELECT] in [Wireless Memory Card] of the  3 menu. (p.86)
Image not found	There are no images that can be transferred when an Eye-Fi card is used.
No wireless memory card inserted	You are trying to perform [Eye-Fi Image Transfer] with no Eye-Fi card inserted.
Cannot be selected	This folder cannot be selected because the number of files stored in this folder exceeds the maximum number allowed.

## Main Specifications





### Model Description

Type	TTL autofocus, auto-exposure SLR digital camera with a built-in retractable P-TTL flash
Lens Mount	PENTAX KAF2 bayonet mount (AF coupler, lens information contacts, K-mount with power contacts)
Compatible Lenses	KAF3, KAF2 (power zoom not compatible), KAF, KA mount lenses

### Image Capture Unit

Image Sensor	Primary color filter, CMOS, Size: 23.5 × 15.6 (mm)
Effective Pixels	Approx. 20.12 megapixels
Total Pixels	Approx. 20.42 megapixels
Dust Removal	SP coating and CMOS sensor vibration
Sensitivity (Standard Output)	ISO AUTO/100 to 51200 (EV steps can be set to 1 EV, 1/2 EV, or 1/3 EV)
Image Stabilizer	Sensor-shift Shake Reduction
AA Filter Simulator	Moiré reduction using SR unit: OFF/Type1/Type2/Bracketing

### File Formats

Recording Formats	RAW (PEF/DNG), JPEG (Exif 2.30), DCF 2.0 compliant
Recorded Pixels	JPEG:  (20M: 5472×3648),  (12M: 4224×2816),  (6M: 3072×2048),  (2M: 1920×1280) RAW:  (20M: 5472×3648)
Quality Level	RAW (12bit): PEF, DNG JPEG: ★★★ (Best), ★★ (Better), ★ (Good) RAW + JPEG simultaneously recordable

Color Space	sRGB, AdobeRGB
Storage Media	SD/SDHC*/SDXC* memory card, Eye-Fi card, FLUCARD (*UHS-I compatible)
Storage Folder	Folder Name: Date (100_1018, 101_1019...) or a user-assigned name (default: PENTX)
Storage File	File Name: user-assigned name (default: IMG****) File No.: Sequential Numbering, Reset

### Viewfinder

Type	Pentaprism Finder
Coverage (FOV)	Approx. 100%
Magnification	Approx. 0.95× (50mm F1.4 at infinity)
Eye-Relief Length	Approx. 20.5 mm (from the view window), Approx. 22.3 mm (from the center of lens)
Diopter Adjustment	Approx. -2.5 to +1.5 m <sup>-1</sup>
Focusing Screen	Interchangeable Natural-Bright-Matte III focusing screen

### Live View

Type	TTL method using CMOS image sensor
Focusing Mechanism	Contrast detection (Face Detection, Face Detection Assist, Tracking, Multiple AF Points, Select, Spot) Focus Peaking: ON/OFF
Display	Field of view: approx. 100%, Magnified view (2×, 4×, 8×, 10×), Grid Display (4 × 4 Grid, Golden Section, Scale), Histogram, Highlight Alert

### LCD Monitor

Type	TFT color LCD monitor, wide angle viewing
Size	3.0 inches

Dots	Approx. 921K dots
Adjustment	Brightness, saturation and colors adjustable

### White Balance

Type	Method using a combination of the CMOS image sensor and the light source detection sensor
Preset Modes	Auto White Balance, Multi Auto White Balance, Daylight, Shade, Cloudy, Fluorescent Light ( <b>D</b> : Daylight Color, <b>N</b> : Daylight White, <b>W</b> : Cool White, <b>L</b> : Warm White), Tungsten Light, Flash, <b>CTE</b> , Manual White Balance, Color Temperature, Copying the white balance settings of a captured image
Fine Adjustment	Adjustable ±7 steps on A-B axis and G-M axis

### Autofocus System

Type	TTL: phase-matching autofocus
Focus Sensor	SAFOX IX i+, 11 points (9 cross type focus points in the center)
Brightness Range	EV -1 to 18 (ISO100, at normal temperature)
AF Modes	Single AF ( <b>A.F.S</b> ), Continuous AF ( <b>A.F.C</b> ), Auto select AF ( <b>A.F.A</b> )
Focus Point Selection Modes	Auto (5 AF Points), Auto (11 AF Points), Select, Expanded Area AF, Spot
AF Assist Light	Dedicated LED AF assist light

### Exposure Control

Type	TTL open-aperture 77 segment metering Metering Modes: Multi-segment metering, Center-weighted metering, Spot metering
Metering Range	EV 0 to 22 (ISO100 at 50mm F1.4)

Exposure Modes	Auto Picture modes: Standard, Portrait, Landscape, Macro, Moving Object, Night Scene Portrait, Sunset, Blue Sky, Forest Scene Modes: Portrait, Landscape, Macro, Moving Object, Night Scene Portrait, Sunset, Blue Sky, Forest, Night Scene, Night Scene HDR*, Night Snap, Food, Pet, Kids, Surf & Snow, Backlight Silhouette, Candlelight, Stage Lighting, Museum *JPEG only Effects Modes: Faded Color, Clear Tone, Brilliant Color, Unicolor Bold, Vintage Color, Cross Processing, Warm Fade, Bold Monochrome, Infrared Filter, Vibrant Color Enhance Program, Sensitivity Priority, Shutter Priority, Aperture Priority, Shutter & Aperture Priority, Manual, Bulb
EV Compensation	±5 EV (1/3 EV steps or 1/2 EV steps can be selected)
AE Lock	Can be assigned to <b>AF/AF-L</b> from the menu.

### Shutter

Type	Electronically controlled vertical-run focal plane shutter
Shutter Speed	Auto: 1/6000 to 30 seconds, Manual: 1/6000 to 30 seconds (1/3 EV steps or 1/2 EV steps), Bulb

### Drive Modes

Mode Selection	Still image: Single frame, Continuous (H, L), Self-timer (12 sec., 2 sec.), Remote Control (0 sec., 3 sec.), Exposure Bracketing Movie: Remote Control Off, Remote Control
Continuous Shooting	Max. approx. 5.4 fps, JPEG (L): ★★★ at Continuous H); 20 frames, RAW: 5 frames, RAW+: 4 frames Max. approx. 3.0 fps, JPEG (L): ★★★ at Continuous L); 100 frames, RAW: 8 frames, RAW+: 4 frames *When the sensitivity is set to ISO100.



### Flash

Built-in Flash	Built-in retractable P-TTL pop-up flash Guide number: approx. 10 (ISO100/m) Angle of view coverage: equivalent to 28mm lens in 35 mm format
Flash Modes	Auto Flash Discharge, Auto Flash +Red-eye Reduction (Auto Picture, Scene Mode), Flash On, Flash On+Red-eye Reduction, Slow-speed Sync, Slow-speed Sync+Red-eye, Trailing Curtain Sync, Manual Flash Discharge (FULL to 1/128 power)
Sync Speed	1/180 sec.
Flash Exposure Compensation	-2.0 to +1.0 EV
External Flash	P-TTL, Leading Curtain Sync, Trailing Curtain Sync, Contrast-control-sync, High-speed Sync, Wireless Sync (available with 2 dedicated external flashes)

### Capture Functions

Custom Image	Bright, Natural, Portrait, Landscape, Vibrant, Radiant, Muted, Bleach Bypass, Reversal Film, Monochrome, Cross Processing
Cross Processing	Random, Preset 1-3, Favorite 1-3
Noise Reduction	Slow Shutter Speed NR, High-ISO NR
Dynamic Range Settings	Highlight Correction, Shadow Correction
Lens Correction	Distortion Correction, Lateral Chromatic Aberration Adjustment, Peripheral Illumination Correction, Diffraction Correction
Digital Filter	Extract Color, Replace Color, Toy Camera, Retro, High Contrast, Shading, Invert Color, Unicolor Bold, Bold Monochrome
HDR Capture	Auto, Type1, Type2, Type3 Bracket Value adjustable Auto Align (automatic composition correction)

## Movie



File Format	MPEG-4 AVC/H.264 (MOV)
Recorded Pixels Framerate	 (1920×1080, 30p/25p/24p)  (1280×720, 60p/50p)
Sound	Built-in stereo microphone Recording Sound Level adjustable
Recording Time	Up to 4 GB or 25 minutes; automatically stops recording if the internal temperature of the camera becomes high.
Custom Image	Bright, Natural, Portrait, Landscape, Vibrant, Radiant, Muted, Bleach Bypass, Reversal Film, Monochrome, Cross Processing
Cross Processing	Random, Preset 1-3, Favorite 1-3
Digital Filter	Extract Color, Replace Color, Toy Camera, Retro, High Contrast, Shading, Invert Color, Unicolor Bold, Bold Monochrome

## Playback Functions

Playback View	Single frame, Multi-image display (6, 12, 20, 35, and 80 thumbnails), Image magnification (Up to 16×, quick zoom), Rotated image display, Histogram (Y histogram, RGB histogram), Highlight Alert, Detailed Information Display, Copyright Information (Photographer, Copyright Holder), Folder Display, Calendar Filmstrip Display, Slideshow, GPS information (Latitude, Longitude, Altitude, Coordinated Universal Time (UTC)), Direction
Delete	Single image, all images, select & delete, folder, Instant Review image
Digital Filter	Base Parameter Adj, Extract Color, Replace Color, Toy Camera, Retro, High Contrast, Shading, Invert Color, Unicolor Bold, Bold Monochrome, Tone Expansion, Sketch, Water Color, Pastel, Posterization, Miniature, Soft, Starburst, Fish-eye, Slim, Monochrome

RAW Development	Development options: Select single image, Select multiple images, Select a folder Development parameters: File Format (JPEG), Aspect Ratio, JPEG Recorded Pixels, JPEG Quality, Color Space, Distortion Correction, Lat-Chromatic-Ab Adj, Peripheral Illumin. Corr., Diffraction Correction, Color Fringe Correction, White Balance, Custom Image, Digital Filter, sensitivity, High-ISO NR, Shadow Correction
Editing Features	Color Moiré Correction, Image Rotation, Resize, Cropping (aspect ratio can be changed and tilt correction is available), Movie Edit (dividing a movie file and deleting unwanted segments), Capturing a JPEG still picture from a movie, Save RAW Data, Eye-Fi Image Transfer

## Customization

Custom Functions	26 items
Mode Memory	11 items
E-Dial Programming/ Button Customization	 button: Green Button, One Push File Format, Optical Preview, Digital Preview, AF Active Area  button: Enable AF1, Enable AF2, Cancel AF, AE Lock E-Dial: Rotate Right, Rotate Left
AF Customization	AF.S Setting: Focus-priority, Release-priority 1st Frame Action in AF.C: Release-priority, Auto, Focus-priority Action in AF.C Continuous: Focus-priority, Auto, FPS-priority Hold AF Status: Off, Low, Medium, High
Text Size	Standard, Large
World Time	World Time settings for 75 cities (28 time zones)
AF Fine Adjustment	±10 steps, adjustment for all lenses or individual lenses (up to 20 values can be saved)
Copyright Information	Names of "Photographer" and "Copyright Holder" are embedded to the image file. A revision history can be checked using the provided software.

**Power Supply**

Battery Type	Rechargeable Lithium-ion Battery D-LI109
AC Adapter	AC Adapter Kit K-AC128 (optional)
Battery Life	<p>Number of recordable images: (with 50% flash usage): approx. 410 images, (without flash usage): approx. 480 images Playback time: approx. 270 minutes</p> <ul style="list-style-type: none"> <li>Tested in compliance with CIPA standard using a fully charged lithium-ion battery at a temperature of 23°C.</li> </ul> <p>Actual results may vary depending on the shooting conditions/circumstances.</p>

**Interfaces**

Connection Port	USB 2.0 (micro B, high-speed compatible), HDMI output terminal (Type D)
USB Connection	MSC/PTP

**Dimensions and Weight**

Dimensions	Approx. 120 mm (W) × 92.5 mm (H) × 69.5 mm (D) (excluding protrusions)
Weight	<p>Approx. 558 g (Including dedicated battery and SD Memory Card)</p> <p>Approx. 498 g (body only)</p>

**Included Accessories**

Package Contents	Strap O-ST132, Rechargeable Lithium-ion Battery D-LI109, Battery Charger D-BC109, AC plug cord, Software (CD-ROM) S-SW151, Start Guide <Mounted to the camera> Eyecup F <sub>R</sub> , Hot shoe cover F <sub>K</sub> , Body mount cover
Software	Digital Camera Utility 5

**Optional Accessories**

GPS Unit	O-GPS1: GPS information (Latitude, Longitude, Altitude, Coordinated Universal Time (UTC)), Direction, Electronic Compass, ASTROTRACER
FLUCARD	Remote capture, image browsing



## Approximate Image Storage Capacity and Playback Time

(When using the fully charged battery)

Battery	Temperature	Normal Shooting	Flash Photography		Playback Time
			50% Use	100% Use	
D-LI109	23°C	480	410	360	270 minutes

- The image storage capacity (normal recording and flash use 50%) is based on measuring conditions in accordance with CIPA standards, while other data is based on our measuring conditions. Some deviation from the above figures may occur in actual use depending on the selected capture mode and shooting conditions.

## Approximate Image Storage Capacity by Size

(When using a 2 GB memory card)

Recorded Pixels		JPEG Quality			PEF	DNG
		★★★	★★	★		
<b>L</b>	20M	134	304	596	59	59
<b>M</b>	12M	224	503	975	–	–
<b>S</b>	6M	418	917	1707	–	–
<b>XS</b>	2M	1024	2119	3615	–	–

- The number of storable images may vary depending on the subject, shooting conditions, selected capture mode and memory card, etc.

## List of World Time Cities

The following cities can be set as Hometown and Destination.

Region	City
<b>North America</b>	Honolulu, Anchorage, Vancouver, San Francisco, Los Angeles, Calgary, Denver, Chicago, Miami, Toronto, New York, Halifax
<b>Central and South America</b>	Mexico City, Lima, Santiago, Caracas, Buenos Aires, Sao Paulo, Rio de Janeiro
<b>Europe</b>	Lisbon, Madrid, London, Paris, Amsterdam, Milan, Rome, Copenhagen, Berlin, Prague, Stockholm, Budapest, Warsaw, Athens, Helsinki, Moscow
<b>Africa/ West Asia</b>	Dakar, Algiers, Johannesburg, Istanbul, Cairo, Jerusalem, Nairobi, Jeddah, Tehran, Dubai, Karachi, Kabul, Male, Delhi, Colombo, Kathmandu, Dacca
<b>East Asia</b>	Yangon, Bangkok, Kuala Lumpur, Vientiane, Singapore, Phnom Penh, Ho chi Minh, Jakarta, Hong Kong, Beijing, Shanghai, Manila, Taipei, Seoul, Tokyo, Guam
<b>Oceania</b>	Perth, Adelaide, Sydney, Noumea, Wellington, Auckland, Pago Pago

## Operating Environment for USB Connection and Provided Software

With the provided software “Digital Camera Utility 5”, you can develop RAW files, make color adjustments, or check shooting information on a computer. Install the software from the provided CD-ROM (S-SW151).

We recommend the following system requirements to connect the camera to a computer and to use the software.

### Windows

<b>OS</b>	Windows 8.1 (32-bit, 64-bit), Windows 8 (32-bit, 64-bit), Windows 7 (32-bit, 64-bit) or Windows Vista (32-bit, 64-bit)
<b>CPU</b>	Intel Core 2 Duo or higher
<b>RAM</b>	2 GB or more
<b>HDD</b>	For installing and starting up the program: 100 MB or more of available space For saving image files: Approx. 5 MB/file (JPEG), Approx. 25 MB/file (RAW)
<b>Monitor</b>	1280×1024 dots, 24-bit full color or higher

### Macintosh

<b>OS</b>	OS X 10.9, 10.8 or 10.7, or Mac OS X 10.6
<b>CPU</b>	Intel Core 2 Duo or higher
<b>RAM</b>	2 GB or more
<b>HDD</b>	For installing and starting up the program: 100 MB or more of available space For saving image files: Approx. 5 MB/file (JPEG), Approx. 25 MB/file (RAW)
<b>Monitor</b>	1280×1024 dots, 24-bit full color or higher

#### Memo

- QuickTime is required to play back movies transferred to a computer with an OS other than Windows 8 and Windows 8.1. (A computer with Windows 8 or Windows 8.1 can play back movies with a pre-installed player software.) You can download it from the following site:  
<http://www.apple.com/quicktime/download/>

## Symbols

	menu.....	19
	menu.....	22
	menu.....	22
	menu.....	23
	menu.....	25
	mode.....	44
	Portrait.....	39
	Landscape.....	39
	Macro.....	39
	Moving Object.....	39
	Night Scene Portrait.....	39
	Sunset.....	39
	Blue Sky.....	39
	Forest.....	40
	Night Scene.....	40
	Night Scene HDR.....	40
	Night Snap.....	40
	Food.....	40
	Pet.....	40
	Kids.....	40
	Surf & Snow.....	40
	Backlight Silhouette... ..	40
	Candlelight.....	40
	Stage Lighting.....	40
	Museum.....	40

## Numerics

1st Frame Action in AF.C.....	50
----------------------------------	----

## A

AA Filter Simulator.....	63
AC adapter.....	30
Action in AF.C Continuous.....	50
Action in M/TAv Mode.....	79
AE Lock.....	44, 77
AE Metering.....	47
AE-L with AF Locked.....	25
<b>AF</b> .....	49
AF area.....	52
AF Assist Light.....	49
AF assist light.....	7
AF coupler.....	7
AF Fine Adjustment.....	53
AF frame.....	35, 36
AF Mode.....	49, 51
AF point.....	50
AF with Remote Control.....	55
<b>AFA</b> .....	49
<b>AF.C</b> .....	49
<b>AFS</b> .....	49
AF.S Setting.....	50
AF/AE-L Button.....	77
Aperture Priority Automatic Exposure.....	42
Aperture value.....	42
Aspect Ratio.....	71, 75
ASTROTRACER.....	94
Auto (AF Active Area).....	50
Auto EV Compensation ...	25

Auto Flash Discharge.....	47
Auto Image Rotation.....	68
<b>AUTO</b> mode.....	35
Auto mode (AF Mode).....	49
Auto Power Off.....	32
Auto Resize.....	86
Autofocus.....	49
AV device.....	68
<b>Av</b> mode.....	42
<b>AWB</b> .....	56
AWB in Tungsten Light... ..	57

## B

<b>B</b> mode.....	42
Backlight Silhouette ( <b>SCN</b> ).....	40
Base Parameter Adj (Digital Filter).....	72
Battery.....	28
Bleach Bypass (Custom Image).....	58
Blue Sky ( <b>SCN</b> ).....	39
Bold Monochrome (Digital Filter).....	60, 72
Bold Monochrome ( <b>EFFECT</b> ).....	41
Bracketing Order.....	55
Bright (Custom Image)....	58
Brightness adjustment.....	61
Brightness histogram.....	15
Brilliant Color ( <b>EFFECT</b> ).....	41
Built-in flash.....	47

Bulb (B) Mode Options....	25
Bulb Exposure.....	42
Button.....	8
Button Customization.....	77

## C

Calendar Filmstrip Display.....	67
Cancel AF.....	77
Candlelight ( <b>SCN</b> ).....	40
Capture mode.....	39
Card access lamp.....	32
Catch-in Focus.....	26
Center-weighted metering.....	47
Changing the image size.....	70
Charging the battery.....	28
City names.....	32, 103
Clear Tone ( <b>EFFECT</b> ).....	41
Cloudy (White Balance).....	56
Color Fringe Correction.....	75
Color Moiré Correction.....	71
Color Space.....	26, 83
Color Temperature.....	58
Color Temperature Steps.....	57
Computer.....	69
Connection cable cover....	30

- Continuous mode
  - (AF Mode) ..... 49
- Continuous playback ..... 67
- Continuous Shooting ..... 54
- Contrast detection AF ..... 49
- Control panel ..... 11, 17
- Copyright Holder ..... 85
- Copyright Information ..... 85
- Correcting images ..... 61
- Create New Folder ..... 83
- Cropping ..... 71
- Cross Processing
  - (Custom Image) ..... 58
- Cross Processing
  - (EFFECT) ..... 41
- CTE** ..... 56
- Custom Image ..... 58
- Custom Setting menus .... 25
- Customization ..... 77
- D**
- Date Adjustment ..... 33
- Daylight (White Balance) ..... 56
- Delete ..... 37
- Delete All Images ..... 22
- Depth of field ..... 43
- Destination ..... 80
- Detailed Information
  - Display ..... 14
- Developing RAW images ..... 75
- Dial ..... 9
- Diffraction Correction ..... 62
- Digital Camera
  - Utility 5 ..... 104
- Digital Filter ..... 60, 72
- Digital Preview ..... 78
- Diopter adjustment
  - lever ..... 16
- Direct keys ..... 16
- Display Color ..... 23
- Distortion Correction ..... 62
- DNG ..... 38
- D-Range Settings ..... 61
- Drive Mode ..... 53
- DST (daylight saving time) ..... 33, 80
- Dust Removal ..... 95
- Dynamic range ..... 61
- E**
- E-dial ..... 9
- E-dial in Program ..... 79
- E-dial Rotation
  - Direction ..... 78
- Editing images ..... 70
- EFFECT** mode ..... 41
- Effects modes ..... 41
- Electronic Compass .. 12, 94
- Error messages ..... 97
- EV Compensation ..... 43
- EV Steps ..... 43
- Expanded Area AF
  - (AF Active Area) ..... 50
- Exposure Bracketing ..... 55
- Exposure modes ..... 42
- External flash ..... 93
- Extract Color
  - (Digital Filter) ..... 60, 72
- Eye-Fi card ..... 31, 86
- Eye-Fi Image Transfer ..... 86
- F**
- Face Detection
  - (Contrast AF) ..... 51
- Face Detection Assist
  - (Contrast AF) ..... 51
- Faded Color (**EFFECT**) ..... 41
- File Format ..... 38
- File Name ..... 83
- File No. .... 84
- Filter ..... 60, 72
- Fine Sharpness
  - (Custom Image) ..... 59
- Firmware ..... 24
- Firmware Info/Options ..... 24
- Fish-eye
  - (Digital Filter) ..... 72
- Flash ..... 47, 93
- Flash (White Balance) ..... 56
- Flash compensation ..... 48
- Flash On ..... 47
- Flicker Reduction ..... 24
- Flucard ..... 31, 86
- Fluorescent
  - (White Balance) ..... 56
- Focus indicator ..... 35
- Focus Method ..... 49
- Focus mode switch .... 35, 49
- Focus Peaking ..... 52
- Folder display ..... 66
- Folder Name ..... 82
- Food (**SCN**) ..... 40
- Forest (**SCN**) ..... 40
- Format ..... 34
- Framerate ..... 38
- Function Restrictions ..... 88
- G**
- GPS Time Sync ..... 94
- GPS unit ..... 94
- Green Button ..... 78
- Grid Display ..... 20
- Grip lamps ..... 8
- Guide Display ..... 35
- Guide number ..... 48
- H**
- HDMI Out ..... 69
- HDR Capture ..... 62
- High Contrast
  - (Digital Filter) ..... 60, 72
- High-ISO NR ..... 46
- Highlight Alert ..... 20, 22
- Highlight Correction ..... 61
- Histogram Display .... 15, 20
- Hold AF Status ..... 50
- Hometown ..... 32, 80
- Hot shoe ..... 7
- I**
- Image Capture
  - Settings ..... 38
- Image finishing tone ..... 58
- Image plane indicator ..... 7
- Image storage
  - capacity ..... 103
- Indicator Lamps ..... 24
- Infrared Filter
  - (EFFECT) ..... 41
- Initial settings ..... 32
- Initializing a memory
  - card ..... 34
- Input Focal Length ..... 91

Instant Review.....	21, 35	Magnifying images .....	37	Museum (SCN).....	40	Playback mode	
Invert Color		Manual Exposure .....	42	Muted		palette .....	64
(Digital Filter).....	60, 72	Manual Flash		(Custom Image) .....	58	Portrait (SCN) .....	39
ISO sensitivity.....	46	Discharge .....	47			Portrait	
<b>J</b>		Manual focus.....	49	<b>N</b>		(Custom Image) .....	58
JPEG .....	38	Manual White Balance ....	57	Natural (Custom		Posterization	
<b>K</b>		Memory .....	81	Image).....	58	(Digital Filter).....	72
Kelvin.....	58	Memory card .....	31	Night Scene (SCN) .....	40	Power .....	32
Kids (SCN).....	40	Menus.....	18	Night Scene HDR		Preview.....	43
<b>L</b>		Meter Operating Time .....	25	(SCN) .....	40	Processing images .....	70
Lamp .....	8	<b>MF</b> .....	49	Night Scene Portrait		Program Automatic	
Landscape (SCN) .....	39	Microphone.....	7	(SCN) .....	39	Exposure .....	42
Landscape		Miniature		Night Snap (SCN).....	40	Protect .....	81
(Custom Image) .....	58	(Digital Filter).....	72	Noise Reduction .....	43, 46	Protect All Images .....	22
Language setting .....	32	Mired .....	58	<b>O</b>		Provided software.....	104
Language/言語 .....	32	Mirror .....	7	One Push File Format .....	78	PTP.....	95
Lat-Chromatic-Ab Adj.....	62	Mode dial.....	35	One-Push Bracketing .....	55	<b>Q</b>	
LCD Display .....	23, 34	Moiré reduction.....	63	Operating		Quality .....	38
LCD Display Settings .....	23	Monitor .....	10	environment .....	104	Quick Zoom .....	22
Lens.....	27, 90	Monochrome		Optical Preview .....	78	QuickTime .....	104
Lens Correction .....	62	(Custom Image) .....	58	Other Indicator Lamps.....	24	<b>R</b>	
Lens focal length .....	92	Monochrome		<b>P</b>		Radiant (Custom	
Lens information		(Digital Filter).....	72	<b>P</b> mode .....	42	Image).....	58
contacts.....	7	Mount type.....	90	Pastel (Digital Filter) .....	72	RAW .....	38
Lens mount index .....	27	Movie Edit.....	73	PEF .....	38	RAW Development .....	75
Lens unlock button .....	27	Movie menu.....	22	Peripheral Illumin.		Rec. Mode menus .....	19
Lens with aperture ring....	92	Movie mode.....	44	Corr. ....	62	Recordable time .....	44
Link AE and AF Point .....	47	Movie SR.....	22	Pet (SCN) .....	40	Recorded Pixels .....	38
Live View .....	11, 20, 36	Moving Object (SCN).....	39	Photographer.....	85	Recording Sound	
<b>M</b>		MSC .....	95	Pixel Mapping.....	95	Level.....	45
<b>M</b> mode .....	42	Multi Auto White Balance		Playback Info Display		Red-eye Reduction.....	47
Macintosh .....	104	(White Balance).....	56	selection screen .....	13	Release While	
Macro (SCN).....	39	Multi-image display.....	65	Playback menu .....	22	Charging.....	48
		Multiple AF Points		Playback mode .....	37		
		(Contrast AF).....	51				
		Multi-segment metering...	47				



## For Using Your Camera Safely

We have paid close attention to the safety of this camera. When using this camera, we request your special attention regarding items marked with the following symbols.



### Warning

This symbol indicates that ignoring this item could cause serious personal injuries.



### Caution

This symbol indicates that ignoring this item could cause minor or medium personal injuries, or loss of property.

## About the Camera



### Warning

- Do not disassemble or modify the camera. High voltage areas are present inside the camera, with the risk of electric shock.
- If the camera interior is exposed due to dropping or otherwise damaging the camera, never touch the exposed portion. There is a risk of electric shock.
- Do not aim the camera at the sun or other strong light sources when taking pictures or leave the camera sitting in direct sunlight with a lens cap off. Doing so may cause the camera to malfunction or cause a fire.
- Do not look at the sun or other strong light sources through a lens. Doing so may lead to a loss of eyesight or cause vision to be impaired.
- If any irregularities occur during use, such as smoke or a strange odor, stop use immediately, remove the battery or the AC adapter, and contact your nearest service center. Continued use can cause a fire or electrical shock.



### Caution

- Do not place your finger over the flash when discharging the flash. You may burn yourself.
- Do not cover the flash with clothing when discharging the flash. Discoloration may occur.
- Some portions of the camera heat up during use. There is a risk of low temperature burns when holding such portions for long periods.

- Should the monitor be damaged, be careful of glass fragments. Also, be careful not to allow the liquid crystal to get on your skin or in your eyes or mouth.
- Depending on your individual factors or physical condition, the use of the camera may cause itching, rashes or blisters. In case of any abnormality, stop using the camera and get medical attention immediately.

## About the Battery Charger and AC Adapter



### Warning

- Always use the battery charger and AC adapter exclusively developed for this camera, with the specified power and voltage. Using a battery charger or AC adapter not exclusive to this camera, or using the exclusive battery charger or AC adapter with an unspecified power or voltage can cause a fire, electric shock, or camera breakdown. The specified voltage is 100 - 240V AC.
- Do not disassemble or modify the product. This can cause a fire or electrical shock.
- If the generation of smoke or strange odor from the product or other abnormality occurs, immediately discontinue using and consult your nearest service center. Continued use can cause a fire or electrical shock.
- If water should happen to get inside the product, consult your nearest service center. Continued use can cause a fire or electrical shock.
- If you see a lightning flash or hear thunder during use of the battery charger or AC adapter, unplug the power plug and discontinue using. Continued use can cause damage to the product, fire or electrical shock.
- Wipe off the power plug if it should become covered with dust. Accumulated dust may cause a fire.
- To reduce the risk of hazards, use only CSA/UL certified power supply cord set, cord is Type SPT-2 or heavier, minimum NO.18 AWG copper, one end with a molded-on male attachment plug cap (with a specified NEMA configuration), and the other is provided with a molded-on female connector body (with a specified IEC nonindustrial type configuration) or the equivalent.



### Caution

- Do not place or drop heavy objects on or forcefully bend the AC plug cord. Doing so may damage the cord. Should the AC plug cord be damaged, consult your nearest service center.

- Do not touch or short-circuit the terminal area of the AC plug cord while the cord is plugged in.
- Do not handle the power plug with wet hands. This can cause an electric shock.
- Do not drop the product, or subject it to violent impact. This can cause the product to breakdown.
- Do not use the battery charger D-BC109 to charge batteries other than the rechargeable lithium-ion battery D-LI109. Attempting to charge other types of batteries may cause an explosion or heating, or may damage the battery charger.

## About the Rechargeable Lithium-ion Battery

### Warning

- If any leakage from the battery should come in contact with your eyes, do not rub them. Flush your eyes with clean water and get medical attention immediately.

### Caution

- Only use the specified battery with this camera. Use of other batteries may cause an explosion or fire.
- Do not disassemble the battery. Disassembling the battery may cause an explosion or leakage.
- Remove the battery from the camera immediately if it becomes hot or begins to smoke. Be careful not to burn yourself during removal.
- Keep wires, hairpins, and other metal objects away from the + and - contacts of the battery.
- Do not short the battery or dispose of the battery in fire. This can cause an explosion or fire.
- If any leakage from the battery should come in contact with skin or clothing, it may cause irritation to the skin. Wash the affected areas thoroughly with water.
- Precautions for D-LI109 Battery Usage:
  - USE SPECIFIED CHARGER ONLY.
  - DO NOT INCINERATE.
  - DO NOT DISASSEMBLE.
  - DO NOT SHORT CIRCUIT.
  - DO NOT EXPOSE TO HIGH TEMP. (140°F / 60°C)

## Keep the Camera and its Accessories out of the Reach of Small Children

### Warning

- Do not place the camera and its accessories within the reach of small children.
  1. If the product falls or is operated accidentally, it may cause serious personal injuries.
  2. Wrapping the strap around a neck may cause suffocation.
  3. To avoid the risk of a small accessory such as the battery or memory cards from being swallowed by mistake, keep them out of the reach of small children. Seek medical attention immediately if an accessory is accidentally swallowed.



## Care to be Taken During Handling

### Before Using Your Camera

- When the camera has not been used for a long time, confirm that it is still working properly, particularly prior to taking important pictures (such as at a wedding or when traveling). Contents of the recording cannot be guaranteed if recording, playback or transferring your data to a computer, etc. is not possible due to a malfunction of your camera or recording media (memory cards), etc.

### About the Battery and Charger

- To keep the battery in optimum condition, avoid storing it in a fully charged state or in high temperatures.
- If the battery is left inserted and the camera is not used for a long time, the battery will over-discharge and shorten the battery's life.
- Charging the battery a day before use or on the day of use is recommended.
- The AC plug cord provided with this camera is developed exclusively for the battery charger D-BC109. Do not use it with other devices.

### Precautions on Carrying and Using Your Camera

- Do not subject the camera to high temperatures or high humidity. Do not leave the camera in a vehicle, as the temperature can get very high.
- Do not subject the camera to strong vibrations, shocks, or pressure. Use a cushion to protect the camera from vibrations of motorcycles, automobiles, or ships.
- The temperature range for camera use is 0°C to 40°C (32°F to 104°F).
- The monitor may appear black at high temperatures, but will return to normal at normal temperatures.
- The monitor may respond more slowly at low temperatures. This is due to liquid crystal properties, and is not a malfunction.

- Sudden temperature changes will cause condensation on the inside and outside of the camera. Place the camera in your bag or a plastic bag, and remove it after temperatures of the camera and surroundings are equalized.
- Avoid contact with garbage, mud, sand, dust, water, toxic gases, or salt. These could cause the camera to breakdown. Wipe the camera to dry off any rain or water drops.
- Do not press on the monitor with excessive force. This could cause it to break or malfunction.
- Be careful not to overtighten the screw in the tripod socket when using a tripod.

### Cleaning Your Camera

- Do not clean the camera with organic solvents such as thinner, alcohol, and benzene.
- Use a lens brush to remove dust accumulated on the lens. Never use a spray blower for cleaning as it may damage the lens.
- Please contact your nearest service center for professional cleaning of the CMOS sensor. (This will involve a fee.)
- Periodic inspections are recommended every one to two years to maintain high performance.

### Storing Your Camera

- Do not store the camera with preservatives or chemicals. Storage in high temperatures and high humidity can cause mold to grow on the camera. Remove the camera from its case and store it in a dry and well-ventilated place.
- Avoid using or storing the camera where it may be exposed to static electricity or electrical interference.
- Avoid using or storing the camera in direct sunlight or in locations where it may be exposed to rapid changes in temperature or to condensation.

## About SD Memory Cards

- The SD Memory Card is equipped with a write-protect switch. Setting the switch to LOCK prevents new data from being recorded on the card, the stored data from being deleted, and the card from being formatted by the camera or computer.
- The SD Memory Card may be hot when removing the card immediately after using the camera.
- Do not remove the SD Memory Card or turn off the power while the card is being accessed. This may cause the data to be lost or the card to be damaged.
- Do not bend the SD Memory Card or subject it to violent impact. Keep it away from water and store away from high temperatures.
- Do not remove the SD Memory Card while formatting. The card may be damaged and become unusable.
- Data on the SD Memory Card may be deleted in the following circumstances. We do not accept any liability for data that is deleted if
  1. the SD Memory Card is mishandled by the user.
  2. the SD Memory Card is exposed to static electricity or electrical interference.
  3. the SD Memory Card has not been used for a long time.
  4. the SD Memory Card or the battery is removed while the card is being accessed.
- If the SD Memory Card is not used for a long time, the data on the card may become unreadable. Be sure to regularly make a backup of important data on a computer.
- Format new SD Memory Cards. Also format SD Memory Cards previously used with other cameras.
- Please note that deleting data stored on an SD Memory Card, or formatting an SD Memory Card does not completely erase the original data. Deleted data can sometimes be recovered using commercially available software. If you are going to discard, give away or sell your SD Memory Card, you should ensure that the data on the card is completely deleted or the card itself is destroyed if it contains any personal or sensitive information.
- The data on your SD Memory Card should be managed at your own risk.

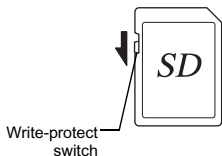

## About Eye-Fi Cards

- An SD Memory Card with a built-in wireless LAN ("Eye-Fi card") can be used with this camera.
- Use of an access point and an Internet connection are required for transferring images via wireless LAN. For details, refer to the Eye-Fi website. (<http://www.eye.fi>)
- Update your Eye-Fi card to the latest firmware before using it.
- Set [Action Mode] to [OFF], or do not use an Eye-Fi card in a location where the use of wireless LAN devices is restricted or prohibited, such as airplanes.
- Eye-Fi cards can be used only in the country in which the card was purchased. Please observe all local laws governing the Eye-Fi card usage.
- This camera features a function to enable/disable the communication function of the Eye-Fi card, however, we do not guarantee the operability of all Eye-Fi card functions.
- Refer to the Eye-Fi card manual for details on how to use the card.
- Please contact the Eye-Fi card manufacturer regarding any malfunctions or problems concerning Eye-Fi cards.

## Trademarks

Microsoft, Windows and Windows Vista are registered trademarks of Microsoft Corporation in the United States of America and other countries. Macintosh, Mac OS, OS X, and QuickTime are trademarks of Apple Inc., registered in the U.S. and other countries. Intel and Intel Core are trademarks of Intel Corporation in the U.S. and/or other countries. SDXC Logo is a trademark of SD-3C, LLC. Eye-Fi, the Eye-Fi logo and Eye-Fi *connected* are trademarks of Eye-Fi, Inc. This product includes DNG technology under license by Adobe Systems Incorporated. The DNG logo is either a registered trademark or trademark of Adobe Systems Incorporated in the United States and/or other countries. HDMI, the HDMI logo and High-Definition Multimedia Interface are trademarks or registered trademarks of HDMI Licensing, LLC in the United States and/or other countries.

All other trademarks are the property of their respective owners.

This product supports PRINT Image Matching III. PRINT Image Matching enabled digital still cameras, printers and software help photographers to produce images more faithful to their intentions. Some functions are not available on printers that are not PRINT Image Matching III compliant. Copyright 2001 Seiko Epson Corporation. All Rights Reserved. PRINT Image Matching is a trademark of Seiko Epson Corporation. The PRINT Image Matching logo is a trademark of Seiko Epson Corporation.



### AVC Patent Portfolio License

This product is licensed under the AVC Patent Portfolio License for the personal use of a consumer or other uses in which it does not receive remuneration to (i) encode video in compliance with the AVC standard ("AVC video") and/or (ii) decode AVC video that was encoded by a consumer engaged in a personal activity and/or was obtained from a video provider licensed to provide AVC video. No license is granted or shall be implied for any other use.

Additional information may be obtained from MPEG LA, L.L.C. See <http://www.mpegla.com>.

### Announcement on the Use of BSD-Licensed Software

This product includes software licensed under the BSD License. BSD license is a form of license which permits the redistribution of the software provided that it is clearly stated that use is unwarranted, and a copyright notice and a list of licensing conditions are provided. The following contents are displayed based on the abovementioned licensing conditions and are not for the purpose of restricting your use of the product, etc.

Tera Term

Copyright (c) T.Teranishi.

Copyright (c) TeraTerm Project.

All rights reserved.

Redistribution and use in source and binary forms, with or without modification, are permitted provided that the following conditions are met:

1. Redistributions of source code must retain the above copyright notice, this list of conditions and the following disclaimer.
2. Redistributions in binary form must reproduce the above copyright notice, this list of conditions and the following disclaimer in the documentation and/or other materials provided with the distribution.
3. The name of the author may not be used to endorse or promote products derived from this software without specific prior written permission.

THIS SOFTWARE IS PROVIDED BY THE AUTHOR "AS IS" AND ANY EXPRESS OR IMPLIED WARRANTIES, INCLUDING, BUT NOT LIMITED TO, THE IMPLIED WARRANTIES OF MERCHANTABILITY AND FITNESS FOR A PARTICULAR PURPOSE ARE DISCLAIMED. IN NO EVENT SHALL THE AUTHOR BE LIABLE FOR ANY DIRECT, INDIRECT, INCIDENTAL, SPECIAL, EXEMPLARY, OR CONSEQUENTIAL DAMAGES (INCLUDING, BUT NOT LIMITED TO, PROCUREMENT OF SUBSTITUTE GOODS OR SERVICES; LOSS OF USE, DATA, OR PROFITS; OR BUSINESS INTERRUPTION) HOWEVER CAUSED AND ON ANY THEORY OF LIABILITY, WHETHER IN CONTRACT, STRICT LIABILITY, OR TORT (INCLUDING NEGLIGENCE OR OTHERWISE) ARISING IN ANY WAY OUT OF THE USE OF THIS SOFTWARE, EVEN IF ADVISED OF THE POSSIBILITY OF SUCH DAMAGE.

## WARRANTY POLICY

All our cameras purchased through authorized bona fide photographic distribution channels are guaranteed against defects of material or workmanship for a period of twelve months from the date of your purchase. Service will be rendered, and defective parts will be replaced without cost to you within that period, provided the camera does not show evidence of impact, sand or liquid damage, mishandling, tampering, battery or chemical corrosion, operation contrary to operating instructions, or modification by an unauthorized repair shop. The manufacturer or its authorized representatives shall not be liable for any repair or alterations except those made with its written consent and shall not be liable for damages from delay or loss of use or from other indirect or consequential damages of any kind, whether caused by defective material or workmanship or otherwise; and it is expressly agreed that the liability of the manufacturer or its representatives under all guarantees or warranties, whether expressed or implied, is strictly limited to the replacement of parts as hereinbefore provided. No refunds will be made on repairs by non-authorized service facilities.

### Procedure During 12-month Warranty Period

Any camera which proves defective during the 12-month warranty period should be returned to the dealer from whom you purchased the camera or to the manufacturer. If there are no representatives of the manufacturer in your country, send the camera to the manufacturer, with postage prepaid. In this case, it will take a considerable length of time before the camera can be returned to you owing to the complicated customs procedures required. If the camera is covered by warranty, repairs will be made and parts replaced free of charge, and the

camera will be returned to you upon completion of servicing. If the camera is not covered by warranty, regular charges of the manufacturer or of its representatives will apply. Shipping charges are to be borne by the owner. If your camera was purchased outside of the country where you wish to have it serviced during the warranty period, regular handling and servicing fees may be charged by the manufacturer's representatives in that country. Notwithstanding this, your camera returned to the manufacturer will be serviced free of charge according to this procedure and warranty policy. In any case, however, shipping charges and customs clearance fees to be borne by the sender. To prove the date of your purchase when required, please keep the receipt or bills covering the purchase of your camera for at least a year. Before sending your camera for servicing, please make sure that you are sending it to the manufacturer's authorized representatives or their approved repair shops, unless you are sending it directly to the manufacturer. Always obtain a quotation for the service charge, and only after you accept the quoted service charge, instruct the service station to proceed with the servicing.

- **This warranty policy does not affect the customer's statutory rights.**
- **The local warranty policies available from our distributors in some countries can supersede this warranty policy. Therefore, we recommend that you review the warranty card supplied with your product at the time of purchase, or contact our distributor in your country for more information and to receive a copy of the warranty policy.**

## **For customers in USA**

### **STATEMENT OF FCC COMPLIANCE**

This device complies with Part 15 of the FCC Rules. Operation is subject to the following two conditions: (1) This device may not cause harmful interference, and (2) this device must accept any interference received, including interference that may cause undesired operation.

Changes or modifications not approved by the party responsible for compliance could void the user's authority to operate the equipment.

This equipment has been tested and found to comply with the limits for a Class B digital device, pursuant to part 15 of the FCC Rules.

These limits are designed to provide reasonable protection against harmful interference in a residential installation. This equipment generates, uses and can radiate radio frequency energy and, if not installed and used in accordance with the instructions, may cause harmful interference to radio communications. However, there is no guarantee that interference will not occur in a particular installation.

If this equipment does cause harmful interference to radio or television reception, which can be determined by turning the equipment off and on, the user is encouraged to try to correct the interference by one or more of the following measures:

- Reorient or relocate the receiving antenna.
- Increase the separation between the equipment and receiver.
- Connect the equipment into an outlet on a circuit different from that to which the receiver is connected.

\* Consult the dealer or an experienced radio/TV technician for help.

## **For customers in Canada**

This Class B digital apparatus complies with Canadian ICES-003.

### **Pour les utilisateurs au Canada**

Cet appareil numérique de la classe B est conforme à la norme NMB-003 du Canada.

### **FOR CALIFORNIA, U.S.A. ONLY**

Perchlorate Material-special handling may apply.

The lithium battery used in this camera contains perchlorate material, which may require special handling.

See [www.dtsc.ca.gov/hazardouswaste/perchlorate](http://www.dtsc.ca.gov/hazardouswaste/perchlorate)

Declaration of Conformity  
According to 47CFR, Parts 2 and 15  
for Class B Personal Computers  
and Peripherals

We: RICOH IMAGING AMERICAS  
CORPORATION

Located at: 633 17<sup>th</sup> Street, Suite 2600  
Denver, Colorado 80202 U.S.A.  
Phone: 800-877-0155  
FAX: 303-790-1131

Declare under sole responsibility that the product identified herein complies with 47CFR Parts 2 and 15 of the FCC rules as a Class B digital device. Each product marketed is identical to the representative unit tested and found to be compliant with the standards. Records maintained continue to reflect the equipment being produced can be expected to be within the variation accepted, due to quantity production and testing on the statistical basis as required by 47CFR §2.909. Operation is subject to the following two conditions: (1) This device may not cause harmful interference, and (2) This device must accept any interference received, including interference that may cause undesired operation. The above named party is responsible for ensuring that the equipment complies with the standards of 47CFR §15.101 to §15.109.

Product Name: SLR Digital Camera  
Model Number: PENTAX K-S1  
Contact person: Customer Service Manager  
Date and Place: August, 2014, Colorado

Information for Users on Collection and Disposal of Old  
Equipment and Used Batteries



1. In the European Union

These symbols on the products, packaging and/or accompanying documents mean that used electrical and electronic equipment and batteries should not be mixed with general household waste.

Used electrical/electronic equipment and batteries must be treated separately and in accordance with legislation that requires proper treatment, recovery and recycling of these products.



By disposing of these products correctly you will help ensure that the waste undergoes the necessary treatment, recovery and recycling and thus prevent potential negative effects on the environment and human health which could otherwise arise due to inappropriate waste handling.

If a chemical symbol is added beneath the symbol shown above, in accordance with the Battery Directive, this indicates that a heavy metal (Hg = Mercury, Cd = Cadmium, Pb = Lead) is present in the battery at a concentration above an applicable threshold specified in the Battery Directive.

For more information about collection and recycling of used products, please contact your local authorities, your waste disposal service or the point of sale where you purchased the products.

## 2. In other countries outside the EU

These symbols are only valid in the European Union. If you wish to discard used products, please contact your local authorities or dealer and ask for the correct method of disposal.

For Switzerland: Used electrical/electronic equipment can be returned free of charge to the dealer, even when you don't purchase a new product. Further collection facilities are listed on the home page of [www.swico.ch](http://www.swico.ch) or [www.sens.ch](http://www.sens.ch).



The CE Mark is a Directive conformity mark of the European Union.

**Memo**



**Memo**

**RICOH IMAGING COMPANY, LTD.**

2-35-7, Maeno-cho, Itabashi-ku, Tokyo 174-8639, JAPAN  
(<http://www.ricoh-imaging.co.jp>)

**RICOH IMAGING EUROPE  
S.A.S**

112 Quai de Bezons, B.P. 204, 95106 Argenteuil Cedex, FRANCE  
(<http://www.ricoh-imaging.fr>)

**RICOH IMAGING  
DEUTSCHLAND GmbH**

Am Kaiserkai 1, 20457 Hamburg, GERMANY  
(<http://www.ricoh-imaging.de>)

**RICOH IMAGING UK LTD.**

PENTAX House, Heron Drive, Langley, Slough, Berks SL3 8PN, U.K.  
(<http://www.ricoh-imaging.co.uk>)

**RICOH IMAGING AMERICAS  
CORPORATION**

633 17th Street, Suite 2600, Denver, Colorado 80202, U.S.A.  
(<http://www.us.ricoh-imaging.com>)

**RICOH IMAGING CANADA  
INC.**

520 Explorer Drive Suite 300, Mississauga, Ontario, L4W 5L1, CANADA  
(<http://www.ricoh-imaging.ca>)

**RICOH IMAGING CHINA CO.,  
LTD.**

23D, Jun Yao International Plaza, 789 Zhaojiabang Road, Xu Hui District,  
Shanghai, 200032, CHINA  
(<http://www.ricoh-imaging.com.cn>)

- Specifications and external dimensions are subject to change without notice.