

# Zaptec Go

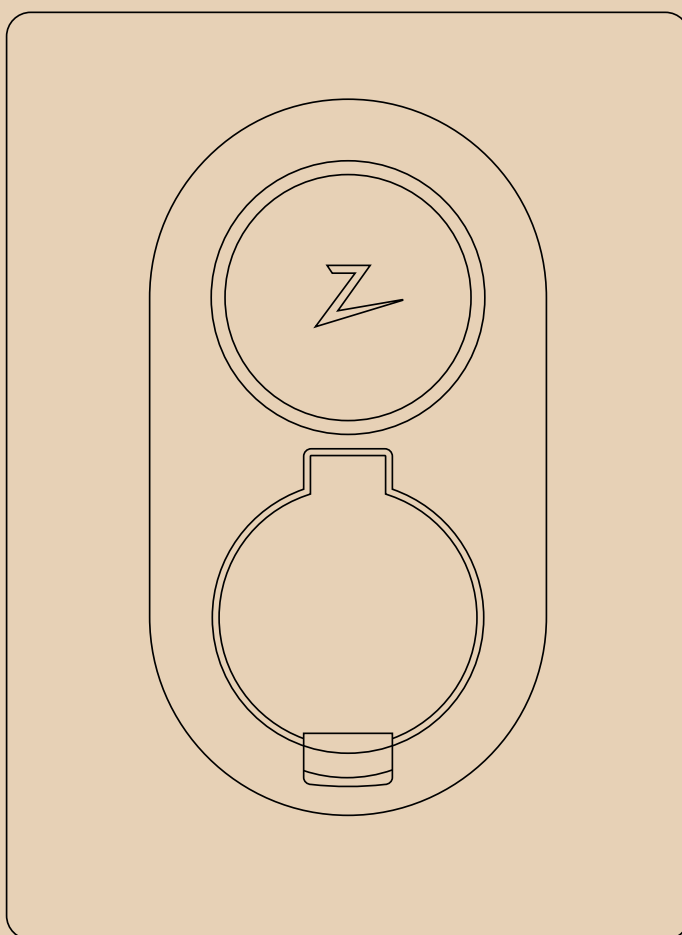

Quick Guide

---

Installer

---

 Zaptec

Smart, small  
and safe

# Zaptec Go

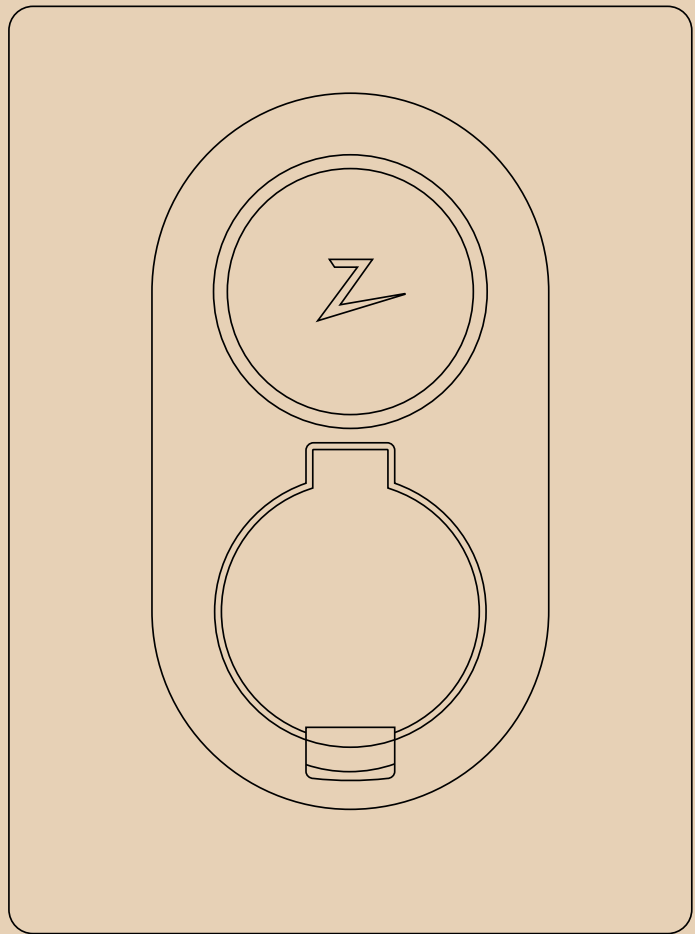
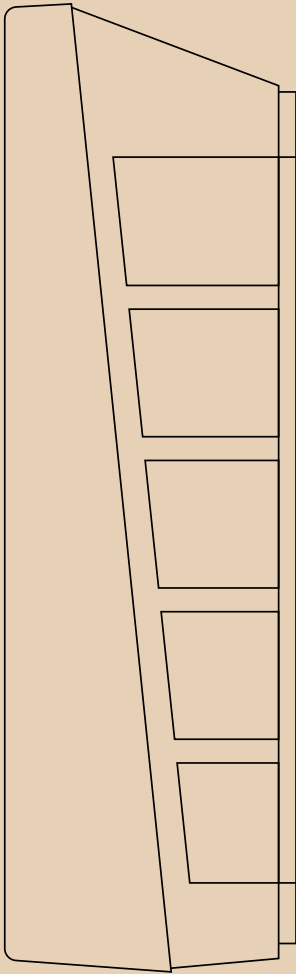

 Zaptec

---

# Get to know Zaptec Go

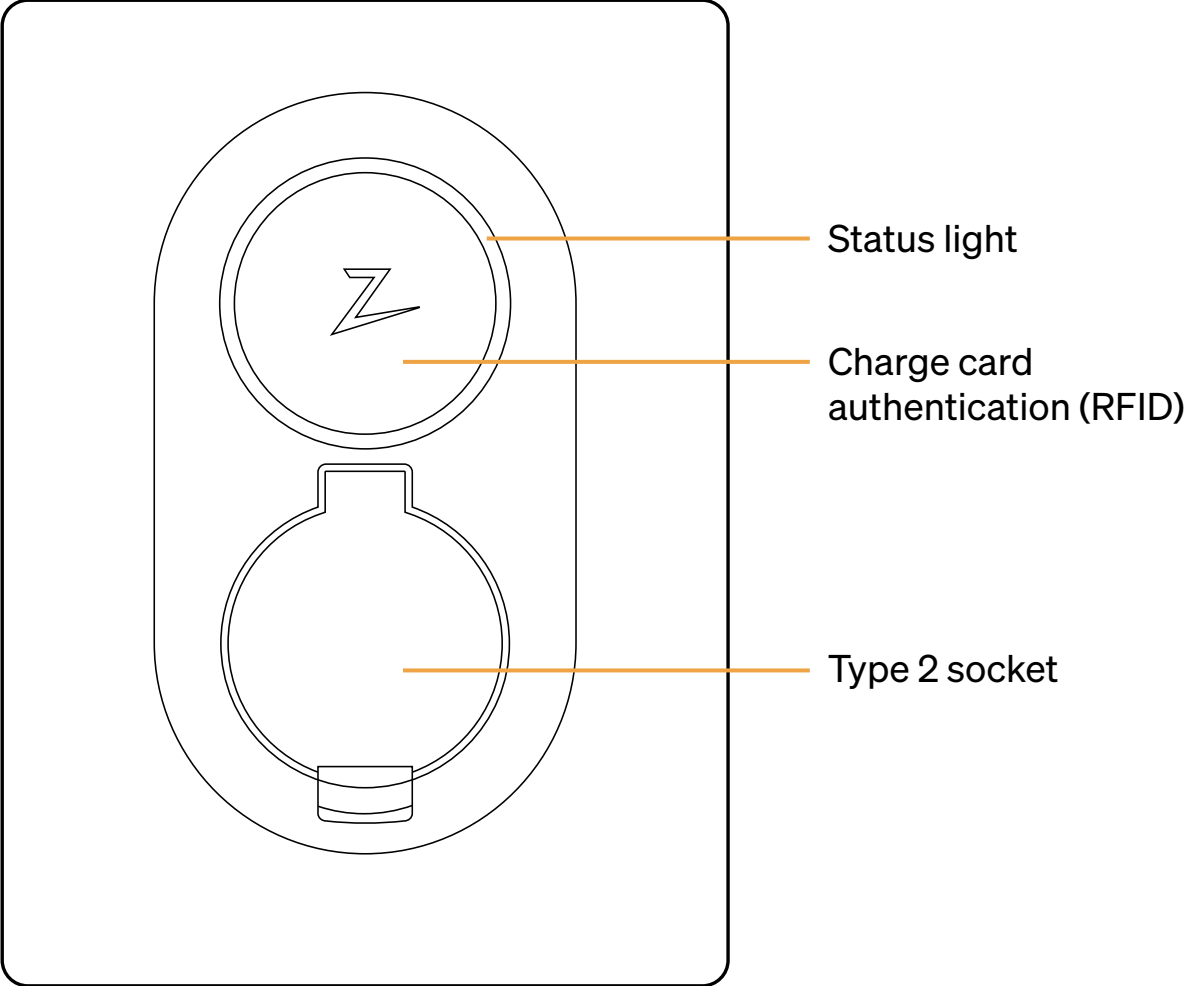

---

Included in the box:

3x Sealing cones



1 x Cable clamp

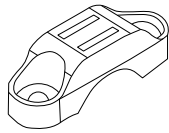

4x TX20

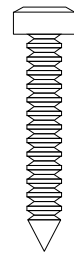

2x TX20

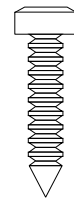

2x TX20

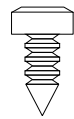

User manual

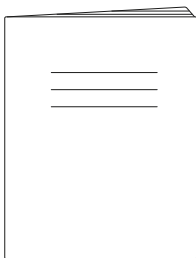

---

**1** Remove Front Cover

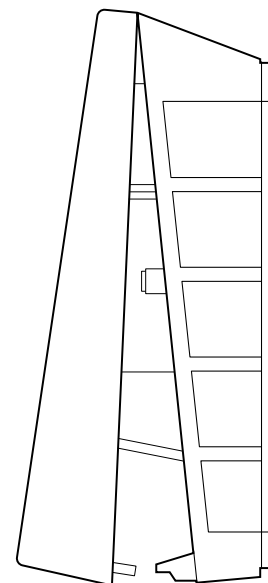
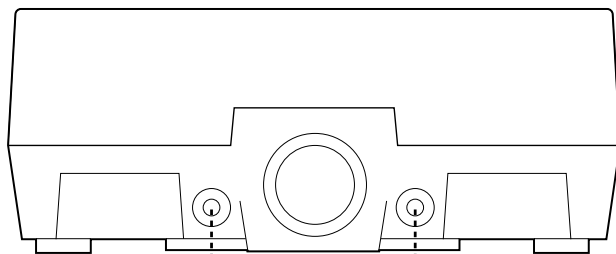

## 2 Mount the charging station

Make sure it's level and at an appropriate height.

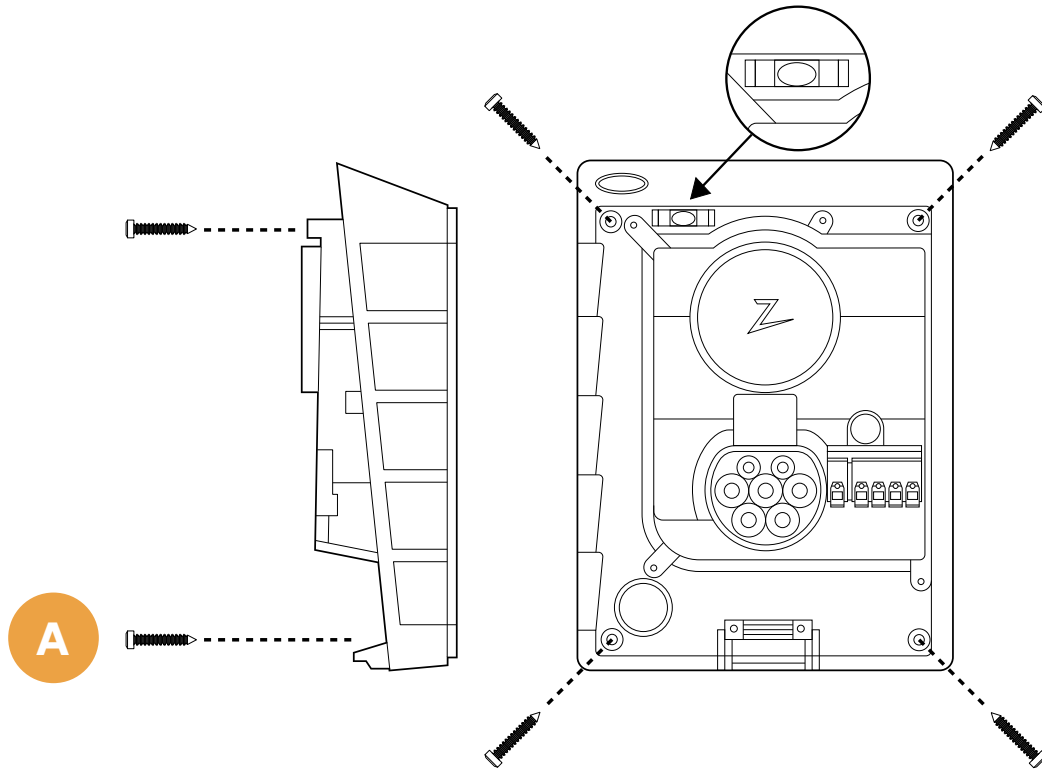

## 3 Place the power cable

Choose between three entry options (top, back and bottom). Punch out the knockout tab to install from 1 or 2.

Each charging station must be protected by a max. 40A Type A 30mA RCD circuit breaker.

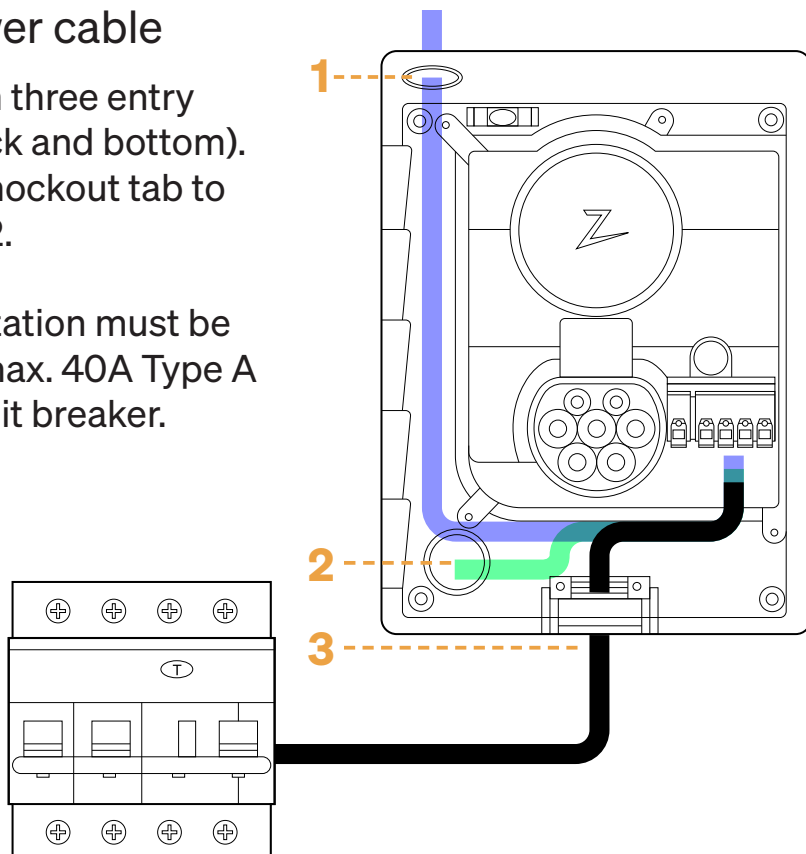

## 4 Secure cable

Prevent cable from being dislocated by using the cable clamp and screws. Use the sealing cones to make the installation water resistant.

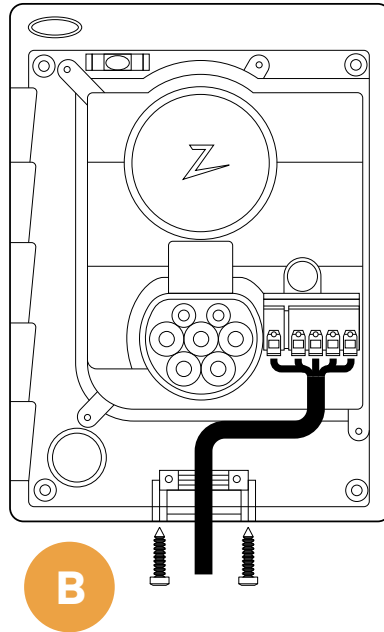

## 5 Electrical connection

Connect all wires and firmly press down all levers as illustrated. Then turn on the circuit breaker to continue.

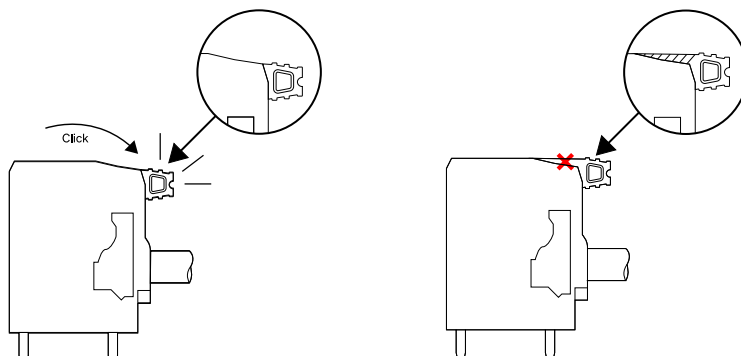
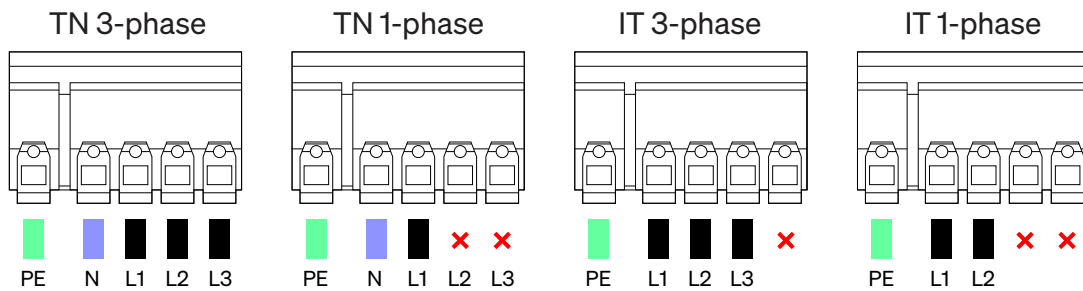

## 6 Configure charging station

Scan the QR code with camera and complete the installation in the Zaptec App.

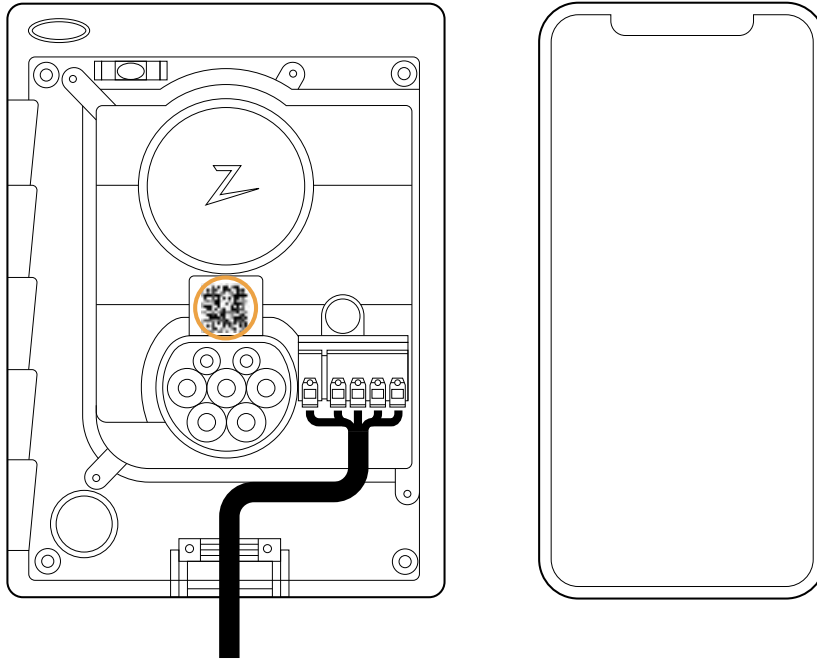

It is possible to configure the charging station without using the app, please note there might be limited functionality doing so.

Switch is located above the connection terminal.

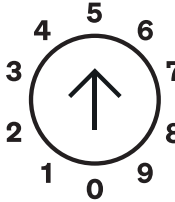
	<b>Switch configurations:</b>	
	1 - 6 Amps	6 - 25 Amps
	2 - 10 Amps	7 - 32 Amps
	3 - 13 Amps	8 - Not in use
	4 - 16 Amps	9 - Not in use
	5 - 20 Amps	0 - Unconfigured or configured with App

---

**7** Confirm green light

Configuration is completed when the charging station status indicator changes to flashing green and then turns to white status indicator.

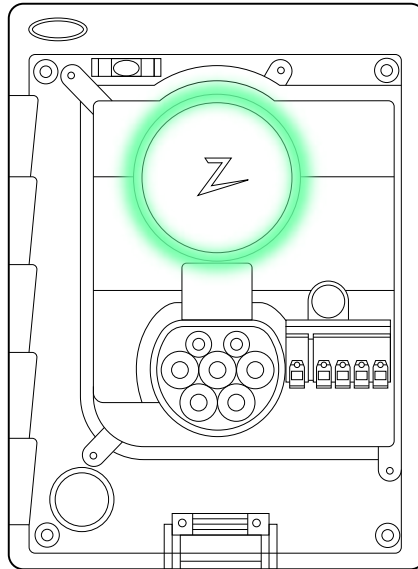

---

**8** Mount the Front Cover

Secure and lock the front cover.

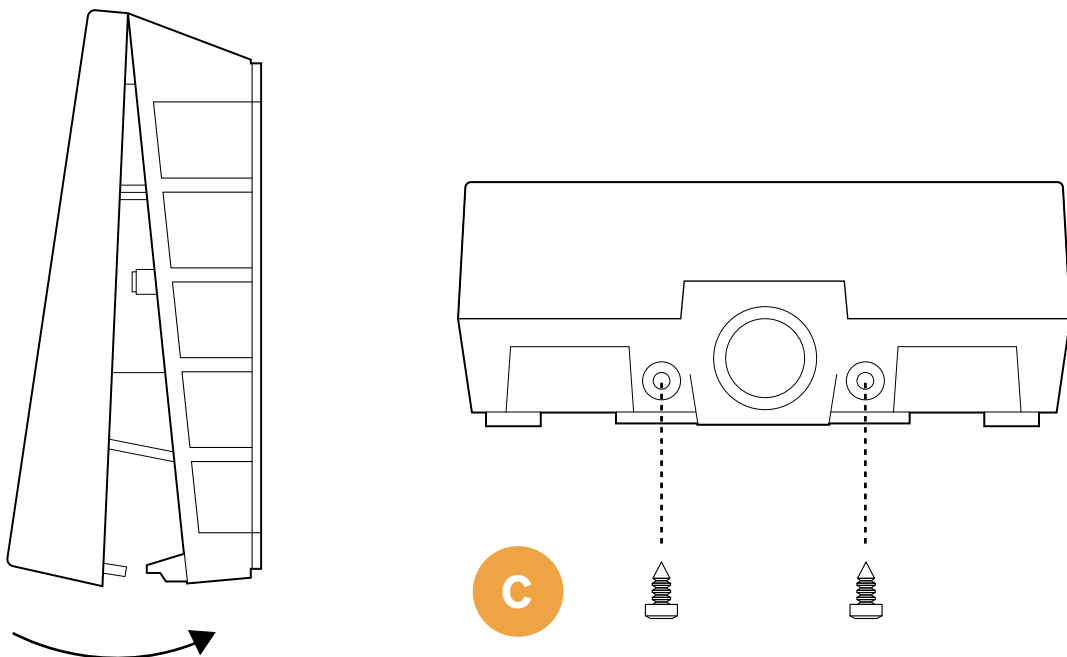



Zaptec Charger AS  
Richard Johnsenstgate 4  
4021 Stavanger  
Norway

Made in Norway



[zaptec.com](http://zaptec.com)