

Bürostühle

(Model # CHAF004)

Assembly Instructions

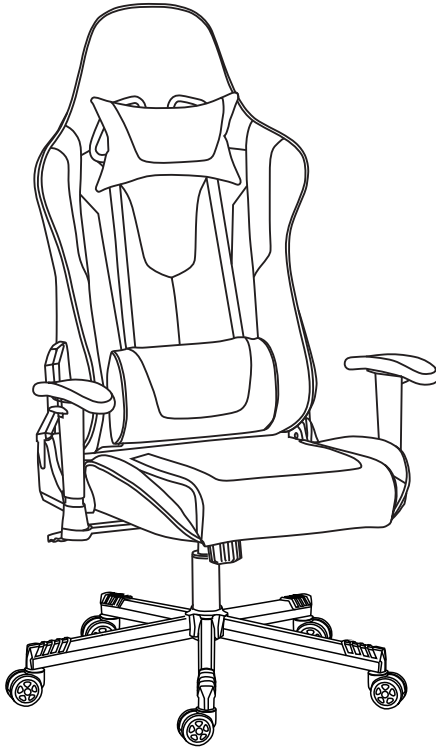



WARNING

To ensure proper assembly, follow all steps and use all parts. Failure to follow this warning can result in serious injury to yourself or others.



ASSEMBLY GUIDE (EN)

1. Congratulations, now you are the new owner of the chair.
2. Before enjoy the comfortable chair, you have to assemble them according to the picture instructions.
3. You can also scan the QR code to refer to the assembly video.
4. It is possible to assemble the chair by your own, while having a second person to help you makes it easier.
5. Please check if there are any missing parts from the package before starting.
6. If there be any issues, please don't hesitate to drop us an email and we'll help you out ASAP.

SAFTY WARNING

1. Do not stand in this chair or use the chair as a step ladder, only as a chair.
2. Children should not use this product without adult supervision.
3. Always use the chair on a flat, stable surface to prevent injury.
4. This chair is designed for one person to use at a time.
5. This chair is designed for one person weighing up to 330 lbs (150 kgs).
6. Do not use this chair unless all bolts, screws and knobs are firmly secured.
7. Some of the part are heavy or has a sharp edge, please install it carefully to avoid hurting you and people around you.
8. After assembling this product, it is advisable to regularly ventilate the room for a few days.
9. Lubricate all moving parts and tighten all bolts/screws every 6 month or whenever needed.
10. Only use wet towels and mild cleaners when cleaning, do not use corrosive cleaners.
11. Keep this instruction manual for future reference.



MONTAGEANLEITUNG(DE)

1. Herzlichen Glückwunsch, jetzt sind Sie der Besitzer eines brandneuen Stuhl.
2. Vor Sie den bequemen Stuhl genießen, müssen Sie ihn gemäß den Bildanweisungen zusammenbauen.
3. Sie können auch den QR-Code scannen, um auf das Montagevideo zu verweisen.
4. Es ist möglich, den Stuhl selbst zusammenzubauen, während Sie eine zweite Person haben, die Ihnen die Arbeit erleichtert.
5. Bitte überprüfen Sie vor dem Start, ob Teile aus der Verpackung fehlen.
6. Wenn es Probleme gibt, schreiben Sie uns bitte eine E-Mail und wir helfen Ihnen so schnell wie möglich.

SICHERHEIT WARNUNG

1. Stellen Sie sich nicht auf diesen Stuhl und benutzen Sie den Stuhl nicht als Trittleiter. Verwenden Sie ihn nur als Stuhl.
2. Kinder sollten dieses Produkt nicht ohne Aufsicht von Erwachsenen verwenden.
3. Verwenden Sie den Stuhl immer auf einer ebenen, stabilen Oberfläche, um Verletzungen zu vermeiden.
4. Dieser Stuhl kann jeweils von einer Person benutzt werden.
5. Dieser Stuhl ist für eine Person mit einem Gewicht von bis zu 330 lbs (150 kgs) ausgelegt.
6. Verwenden Sie diesen Stuhl nur, wenn alle Bolzen, Schrauben und Knöpfe festsitzen.
7. Ein Teil des Teils ist schwer und / oder hat eine Formkante. Bitte installieren Sie es sorgfältig, um Verletzungen und Personen in Ihrer Umgebung zu vermeiden.
8. Nach dem Zusammenbau dieses Produkts ist es ratsam, den Raum einige Tage lang regelmäßig zu lüften.
9. Schmieren Sie alle beweglichen Teile und ziehen Sie alle 6 Monate oder bei Bedarf alle Schrauben fest.
10. Verwenden Sie zum Reinigen nur feuchte Handtücher und milde Reinigungsmittel. Verwenden Sie keine ätzenden Reinigungsmittel.
11. Bewahren Sie diese Bedienungsanleitung zum späteren Nachschlagen auf.



Guide d'installation(FR)

1. Félicitations, vous êtes maintenant propriétaire d'une chaise
2. Avant de profiter de cette chaise confortable, vous devez l'assembler selon les étapes indiquées sur la figure, ou vous pouvez scanner le code QR pour vous référer à la vidéo d'assemblage.
3. Vous pouvez assembler la chaise vous-même, et avoir une autre personne pour vous aider facilitera l'assemblage.
4. Veuillez vérifier l'emballage des pièces manquantes avant de commencer.
5. Si vous avez des questions, n'hésitez pas à nous envoyer un courriel, nous vous aiderons dans les plus brefs délais.

Précautions

1. Ne vous tenez pas sur cette chaise ou n'utilisez pas cette chaise comme échelle, utilisez-la uniquement comme chaise
2. Les enfants ne doivent pas jouer avec le produit sans la surveillance d'un adulte.
3. Assurez-vous de l'utiliser sur un sol plat et stable pour éviter les blessures.
4. Cette chaise est conçue pour être utilisée par une seule personne.
5. La capacité de charge maximale de cette chaise est de 330lbs (150)kgs , veuillez ne pas l'utiliser avec un surpoids.
6. Veuillez utiliser cette chaise lorsque tous les boulons, vis et boutons sont fermement fixés
7. Certaines pièces sont lourdes ou ont des arêtes vives. Veuillez l'installer soigneusement pour éviter de vous blesser ainsi que les personnes autour de vous.
8. Après avoir installé ce produit, il est recommandé de ventiler pendant quelques jours.
9. Lubrifiez toutes les pièces mobiles et serrez tous les boulons / vis tous les 6 mois
10. Lors du nettoyage, n'utilisez que des serviettes humides et des détergents doux, n'utilisez pas de détergents corrosifs.
11. Conservez ce manuel d'instructions pour référence ultérieure.



Guida d'installazione(IT)

1. Congratulazioni, ora sei il proprietario di una nuova sedia di zecca
2. Prima di goderti una sedia comoda, devi montarla secondo i passaggi mostrati in figura, oppure puoi scansionare il codice QR per fare riferimento al video di montaggio.
3. Puoi assemblare la sedia da solo e avere un'altra persona che ti aiuti renderà il montaggio più facile.
4. Controlla il pacchetto per parti mancanti prima di iniziare.
5. In caso di domande, non esitare a contattarci via email, ti aiuteremo il prima possibile.

Precauzioni

1. Non salire su questa sedia o usare questa sedia come scala, usala solo come sedia
2. I bambini di 13 anni non devono giocare con il prodotto senza la supervisione di un adulto.
3. Utilizza la sedia su un terreno piano e stabile per evitare lesioni.
4. Questa sedia è progettata per essere utilizzata da una persona alla volta.
5. La capacità di carico massima di questa sedia è di 330 lbs (150kgs), non utilizzarla in caso di sovrappeso.
6. Utilizza questa sedia quando tutti i bulloni, le viti e le manopole sono saldamente fissati
7. Alcune parti sono pesanti o hanno bordi taglienti. Installa con cura per evitare di ferire te e le persone intorno a te.
8. Dopo aver installato questo prodotto, si consiglia di ventilare per alcuni giorni.
9. Lubrifica tutte le parti mobili e serra tutti i bulloni/viti ogni 6 mesi
10. Durante la pulizia, utilizza solo asciugamani bagnati e detergenti delicati, non utilizzare detergenti corrosivi.
11. Conserva questo manuale di istruzioni per riferimenti futuri.













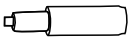







GUIA DE MONTAJE(ES)

1. Felicitaciones, ahora eres el propietario de una nueva silla
2. Antes de usar de la silla cómoda, debe ensamblarlos con las instrucciones de la imagen.
3. También puede escanear el código QR para visitar el video de montaje.
4. Es posible montar la silla por su cuenta, mientras que si tiene una segunda persona que le ayude lo hace más fácil.
5. Antes de comenzar el montaje, compruebe si falta alguna pieza en el paquete.
6. Si hay algún problema, no dude en enviarnos un correo electrónico y lo ayudaremos lo antes posible.

ADVERTENCIA DE SEGURIDAD

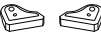
1. Por favor no ponerse en pie en esta silla ni use la silla como escalera de mano, sólo úsarla solo como silla
2. Los niños no deben usar este producto sin la supervisión de adulto.
3. Por favor siempre utilice la silla sobre una superficie plana y estable para evitar lesiones.
4. Esta silla está diseñada para una persona a la vez.
5. Esta silla está diseñada para una persona que pesa hasta 330 lbs (150 kgs)
6. No use esta silla a menos que todos los pernos, tornillos y perillas estén firmemente asegurados.
7. Algunas de las piezas son pesadas / o tienen borde de aguzado, instálelas con cuidado para evitar lastimarlo a usted ya las personas que lo rodean.
8. Después de ensamblar este producto, es aconsejable ventilar regularmente la habitación durante unos días.
9. Lubrique todas las piezas móviles y apriete todos los pernos / tornillos cada 6 meses.
10. Por favor utilice únicamente toallas húmedas y limpiadores suaves para limpiar, no utilice limpiadores corrosivos.
11. Por favor guarde este manual de instrucciones para futuras consultas.

A		5
B		5
C		1
D		1
E		1
F		1
G	 M8x20mm	12
G1	 M8x25mm	8
G2	 M5x8mm	4
G3	 M6x15mm	5

G4		4
H		1
I		1
J		1
K		1
M		1
N		1
O		1
L	 5#	1

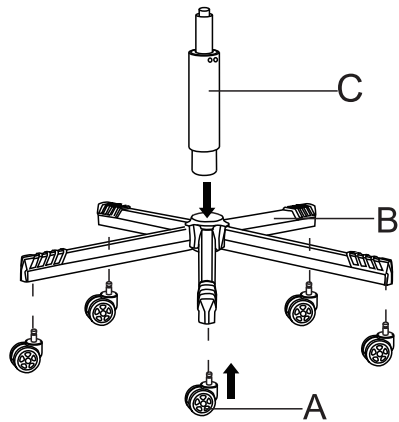
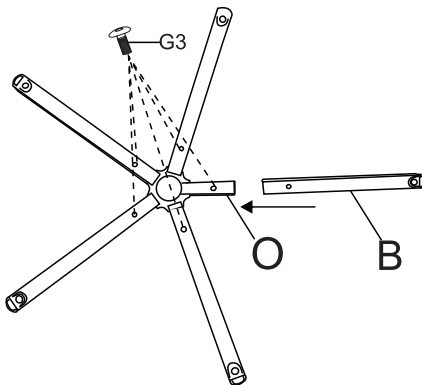

1

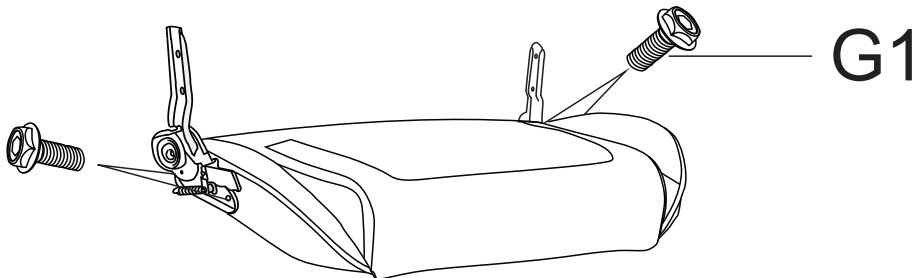

2

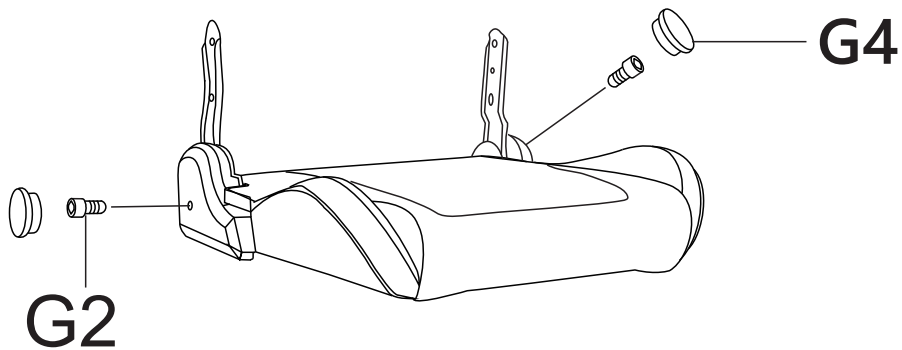

3

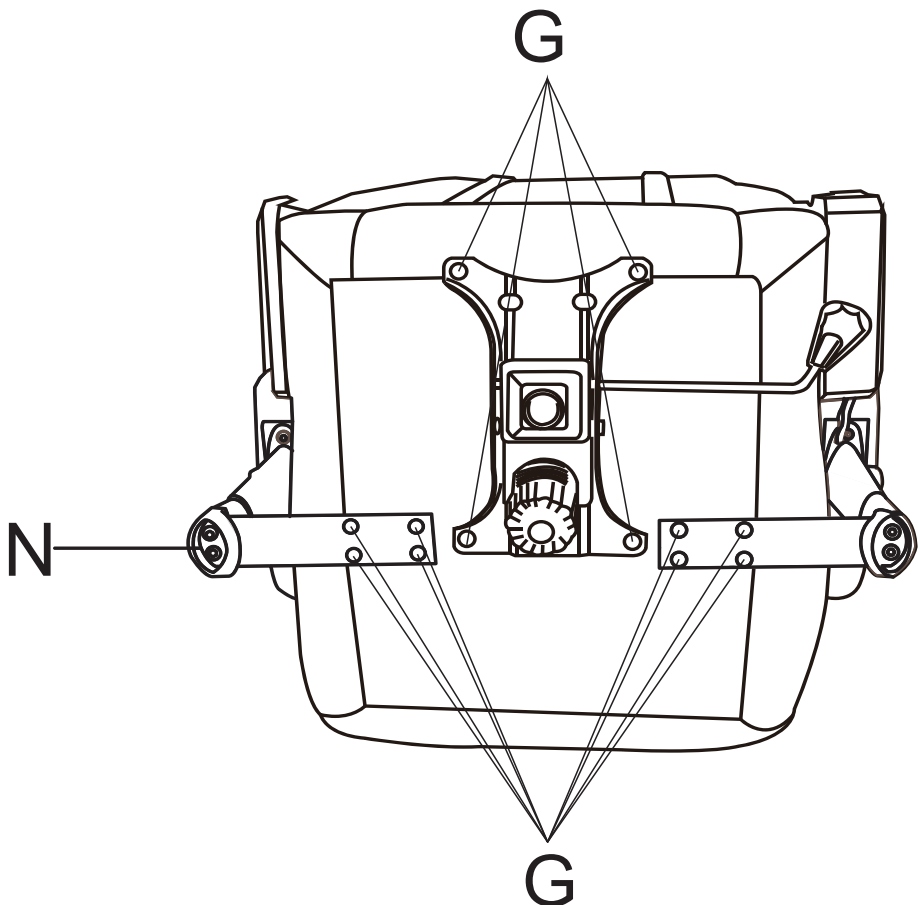

4

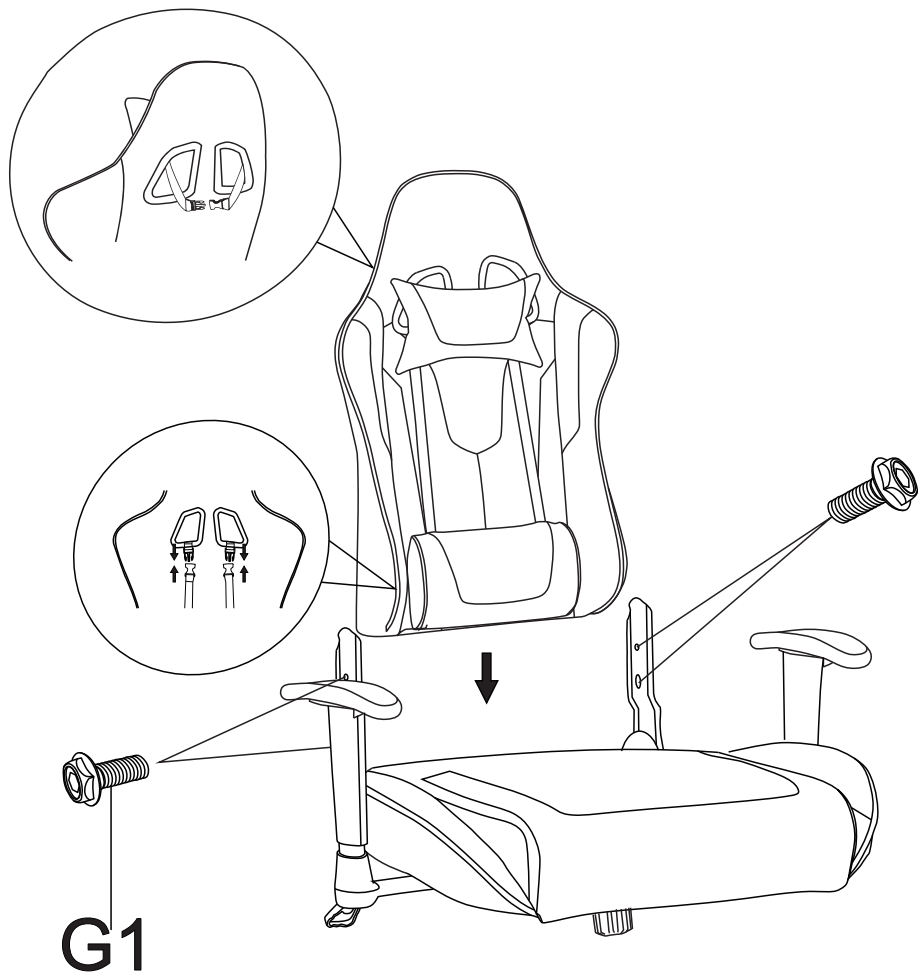

5

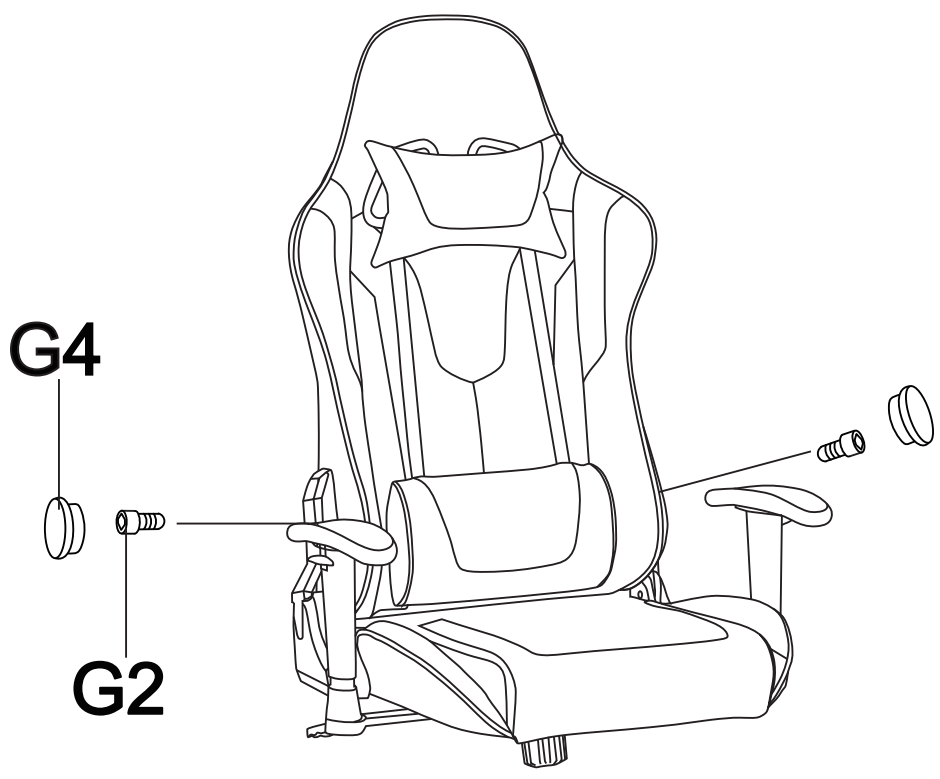

6



7

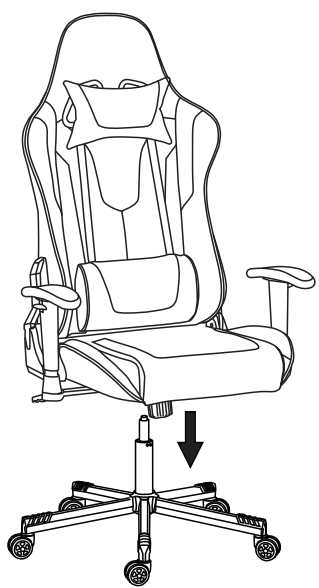

8





Note: When lowering down the seat height, please make sure to fully sit on the seat (as the right figure shows below) in order to give it enough pressure.



Thank you for purchasing

We are dedicated to bringing you the best online shopping experience and making your life comfortable. We pride ourselves on an integrated supply chain team that works meticulously to deliver you products and service with greatest value, our networks span across the US, the United Kingdom, Germany, France and six more European countries. It is always our belief that how customers view our business and service ultimately defines our brand.

So, how did we do? Please let us know by making an online remark about it.

😊 **Good job.** Would you like to share your experience to assist others with their shopping decisions?

☹️ **Not good.** Can you give us a chance to fix the problem?



Easy Return

We work hard to make sure order arrives safe and secure, but rest assured we will take care of it if it is not up to standard. If you need replacement parts, contact us we will send you replacements with no hassle.



Contact Us

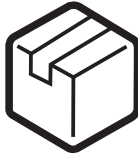

Replacement



You

You don't have to worry about re-packaging / schedule pick-up.