



OWNER'S MANUAL

SXS

REFRIGERATOR

Please read this guide thoroughly before operating and keep it handy for reference at all times.

Important**(In the UK Only)**

The wires in this mains lead are coloured in accordance with the following code:

GREEN AND YELLOW: EARTH
 BLUE: NEUTRAL
 BROWN: LIVE

This appliance must be earthed

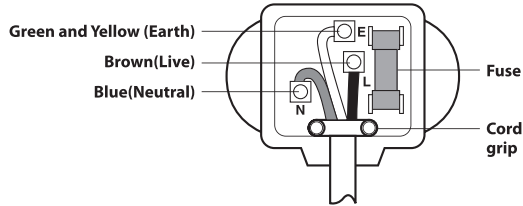

As the colours of the wires in the mains lead of this apparatus may not correspond with the coloured markings identifying the terminals in your plug, proceed as follows:

The wire which is coloured Green and Yellow must be connected to the terminal in the plug which is marked with the letter E or by the earth symbol (\perp) or coloured Green or Green and Yellow.

The wire which is coloured Blue must be connected to the terminal which is marked with the letter N or coloured Black.

The wire which is coloured Brown must be connected to the terminal which is marked with the letter L or coloured Red.

If a 13 amp (BS 1363) plug is used, fit a 13 amp BS 1362 fuse.

Table of contents

Introduction	Entry	4
	Important safety instruction	4
	Where to install	7
	Identification of parts	8
Installation	Door removal	9
	Door replacement	9
	Height adjustment	10
	Door Alignment	10
Operation	Starting	11
	Adjusting the temperatures and functions	11
	Ice making	14
	Refreshment center (Applicable to some models only)	15
	Shelf	15
	Two stars section (Applicable to some models only)	15
	LED indicator (Freezer/Refrigerator)	16
	Pure N Fresh (Applicable to some models only)	16
	Wine holder (Applicable to some models only)	17
	Egg box (Applicable to some models only)	17
Deodorizer (Applicable to some models only)	17	
Suggestion on food storage	Location of foods	18
	Storing foods	19
	Energy-Saving Method	19
Care and maintenance	How to dismantle parts	20
	General information	21
	Cleaning	21
	Trouble shooting	22
	It is normal...	26
	Smart Diagnosis (Applicable to some models only)	27

Entry

The model and serial numbers are found on the inner case or back of refrigerator compartment of this unit. These numbers are unique to this unit and not available to others. You should record requested information here and retain this guide as a permanent record of your purchase. Staple your receipt here.

Date of purchase : _____
 Dealer purchased from : _____
 Dealer address : _____
 Dealer phone no. : _____
 Model no. : _____
 Serial no. : _____

Important safety instruction

Before it is used, this refrigerator must be properly installed and located in accordance with the installation instructions in this document.

When moving your appliance away from the wall, be careful not to roll over the power cord or to damage it in any way.

After your refrigerator is in operation, do not touch the cold surfaces in the freezer compartment, particularly when your hands are damp or wet. Skin could adhere to these extremely cold surfaces.

Unplug the power cord from the power outlet for cleaning or other requirements. Never touch it with wet hands because you can get an electric shock or be hurt.

Never place glass products in the freezer because they may be broken due to expansion when their contents are frozen.

Never allow your hands within the ice storage bin of the automatic ice maker. You could be hurt by the operation of the automatic ice maker.

If possible, connect the refrigerator to its own individual electrical outlet to prevent it and other appliances or household lights from causing an overload that could cause a power outage.

The refrigerator-freezer should be so positioned that the supply plug is accessible for quick disconnection when accident happens.

If the supply cord is damaged, it must be replaced by the manufacturer, its service agent or similarly qualified persons in order to avoid a hazard.

The new hose-sets supplied with the appliance are to be used and that old hose-sets should not be reused.

Don't use an extension cord

Accessibility of Supply Plug

Supply Cord Replacement

 **CAUTION**

⚠ WARNING

Always remove power cord from the wall outlet prior to cleaning in the vicinity of electrical parts (lamps, switches, controls, etc.).

Wipe up excess moisture with a sponge or cloth to prevent water or liquid from getting into any electrical part and causing an electric shock.

Never use metallic scouring pads, brushes, coarse abrasive cleaners, strong alkaline solutions, flammable or toxic cleaning liquids on any surface.

Do not touch frozen surfaces with wet or damp hands, because damp object will stick or adhere to extremely cold surfaces.

⚠ WARNING

Risk of child entrapment.

When disposing the refrigerator, remove the packing materials from the door or take off the doors but leave the shelves in place so that children may not easily climb inside.

⚠ CAUTION

This appliance can be used by children aged from 8 years and above and persons with reduced physical, sensory or mental capabilities or lack of experience and knowledge if they have been given supervision or instruction concerning use of the appliance in a safe way and understand the hazards involved. Children shall not play with the appliance. Cleaning and user maintenance shall not be made by children without supervision.

Don't store

Don't store or use gasoline or other flammable vapor and liquids in the vicinity of this or any other appliance.

Do not store explosive substances such as aerosol cans with a flammable propellant in this appliance.

Grounding (Earthing)

In the event of an electric short circuit, grounding (earthing) reduces the risk of electric shock by providing an escape wire for the electric current.

In order to prevent possible electric shock, this appliance must be grounded. Improper use of the grounding plug can result in an electric shock. Consult a qualified electrician or service person if the grounding instructions are not completely understood, or if you have doubts on whether the appliance is properly grounded.

⚠ WARNING

If LED lamp is damaged, it should be replaced by the service center instead of on your own.

Disposal of the old appliance

This appliance contains fluid (refrigerant, lubricant) and is made of parts and materials which are reusable and/or recyclable.

All the important materials should be sent to the collection center of waste material and can be reused after rework (recycling). For take back, please contact with the local agency.

WARNING

- ▲ Keep ventilation openings, in the appliance enclosure or in the built-in structure, clear of obstruction.
- ▲ Do not use mechanical devices or other means to accelerate the defrosting process, other than those recommended by the manufacturer.
- ▲ Do not damage the refrigerant circuit.
- ▲ Do not use electrical appliances inside the food storage compartments of the appliance, unless they are of the type recommended by the manufacturer.
- ▲ The refrigerant and insulation blowing gas used in the appliance require special disposal procedures. When disposal, please consult with service agent or a similarly qualified person.



This appliance contains a small amount of isobutane refrigerant (R600a), natural gas with high environmental compatibility, but it is also combustible. When transporting and installing the appliance, care should be taken to ensure that no parts of the refrigerating circuit are damaged. Refrigerant squirting out of the pipes could ignite or cause an eye injury. If a leak is detected, avoid any naked flames or potential sources of ignition and air the room in which the appliance is standing for several minutes.

In order to avoid the creation of a flammable gas air mixture if a leak in the refrigerating circuit occurs, the size of the room in which the appliance may be sited depends on the amount of refrigerant used. The room must be 1m² in size for every 8g of R600a refrigerant inside the appliance. The amount of refrigerant in your particular appliance is shown on the identification plate inside the appliance. Never start up an appliance showing any signs of damage. If in doubt, consult your dealer.

CAUTION

- Do not directly spray water inside or outside the refrigerator. - There is a risk of fire or electric shock.
- Do not spray cleaning products directly on the display. - Printed letters on the display may come off.
- Remove any foreign matter or dust from the power plug pins. But do not use a wet or damp cloth when cleaning the plug, remove any foreign material or dust from the power plug pins. - Otherwise there is a risk of fire or electric shock.

Select a good location**Where to Install**

1. Place your appliance where it is easy to use.
2. Avoid placing the unit near heat sources, direct sunlight or moisture.
3. To ensure proper air circulation around the fridge-freezer, please maintain sufficient space on both the sides as well as top and maintain at least 2 inches (5 cm) from the rear wall.
4. To avoid vibrations, the appliance must be leveled.
5. Don't install the appliance below 5°C. It may cause affect the performance.
6. This appliance is intended to be used in household and similar applications such as staff kitchen areas in shops, offices and other working environments; farm houses and by clients in hotels, motels and other residential type environments;bed and breakfast type environments;catering and similar non retail applications.

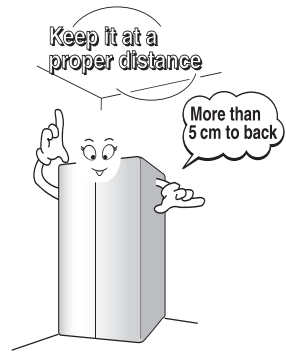

Identification of parts

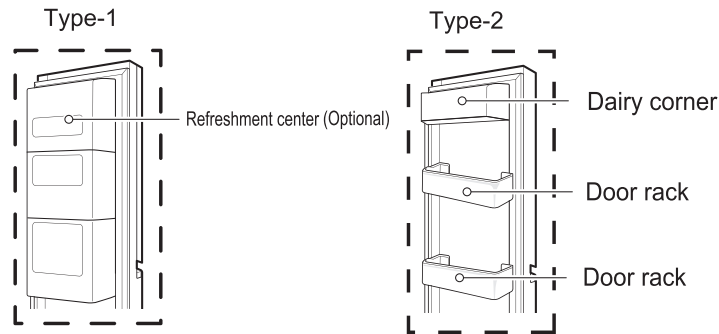
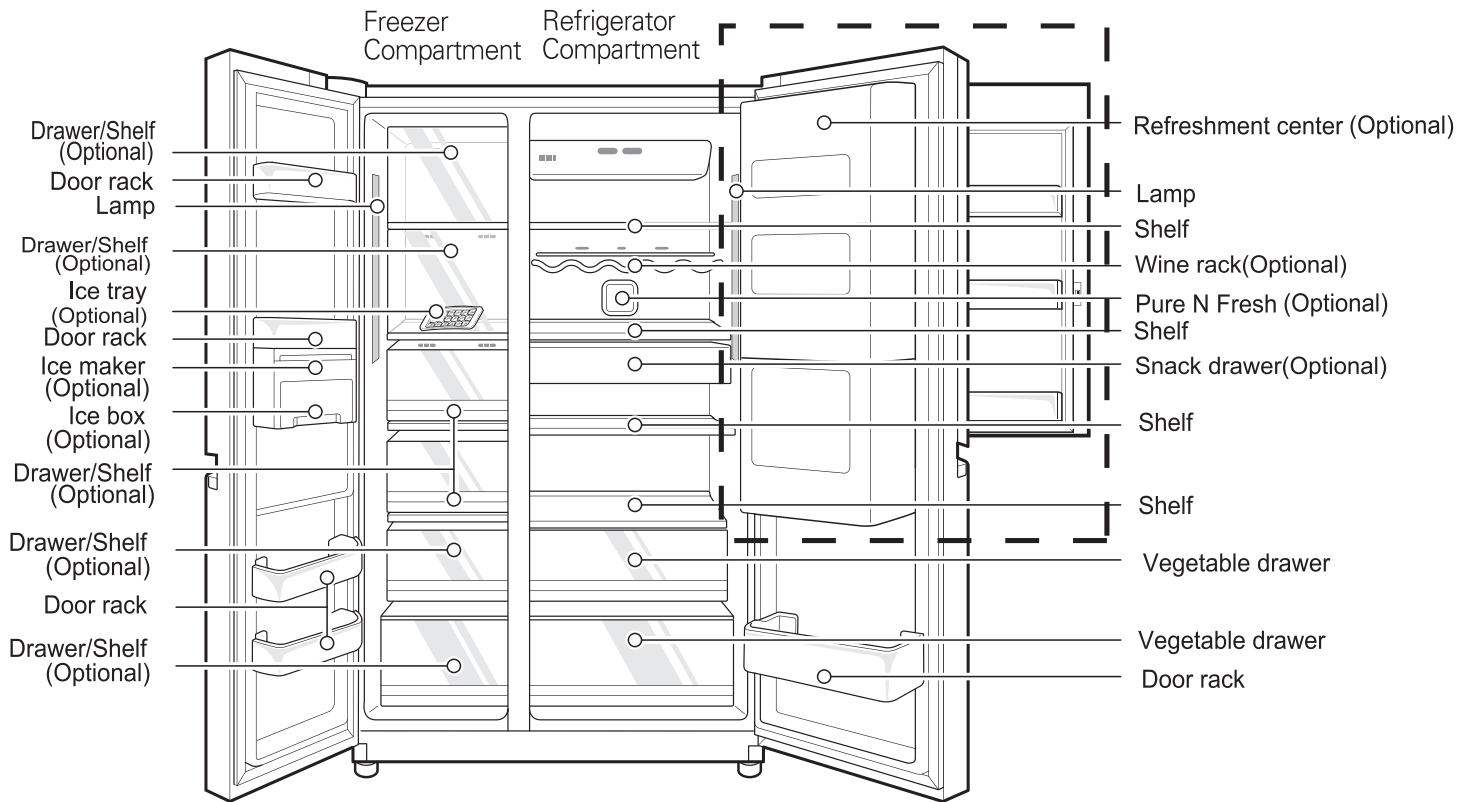

NOTE

• Parts, features, and options vary by model. Your model may not include every option.

⚠ WARNING

Remove the freezer compartment door

Door removal

Electric Shock Hazard

Disconnect electrical supply to refrigerator before installing. Failure to do so could result in death or serious injury.

If your access door is too narrow for the refrigerator to pass through, remove the refrigerator door and pass the refrigerator laterally.

- 1) Removing the hinge cover, and Main PCB cover by loosening the screws. Separate all connection wires.
- 2) Remove the keeper by rotating it counter clockwise (①) and then lifting the upper hinge up (②).

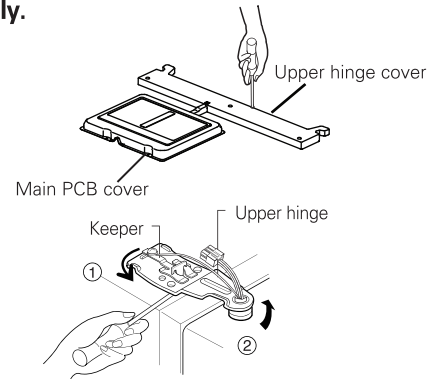

⚠ CAUTION

When removing the upper hinge, be careful that the door does not fall forwards.

- 3) Remove the freezer compartment door by lifting it upward.

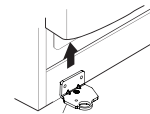

Remove the refrigerator door

- 1) Removing the hinge cover, and Main PCB cover by loosening the screws. Separate all connection wires.
- 2) Remove keeper by rotating it clockwise (①) and then remove the upper hinge by lifting it up (②).
- 3) Remove the refrigerator compartment door by lifting it up.

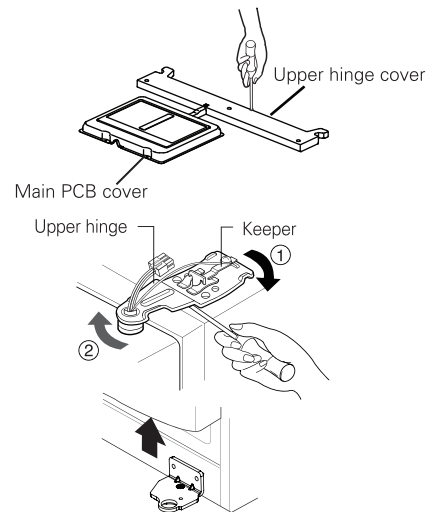

Pass the refrigerator

Pass the refrigerator laterally through the access door as shown in the right figure.

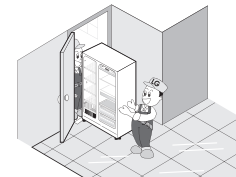

Door replacement

Mount them in the reverse sequence of removal after they pass through the access door.

If the height of freezer compartment door is different from the height of Refrigerator compartment door

Height adjustment

If the freezer compartment door is lower than the refrigerator compartment door

Level the door by inserting flat (-type) driver into the groove of the left height adjusting screw and rotate it clockwise (①).

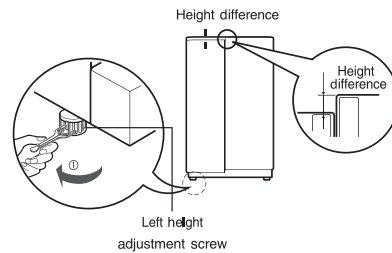

If the freezer compartment door is higher than the refrigerator compartment door

Level the door by inserting flat (-type) driver into the groove of the right height adjusting screw and rotate it clockwise (①).

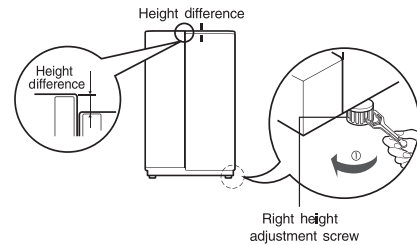

Door Alignment

If the doors are still uneven after the refrigerator has been leveled, finish adjusting the doors by following the instructions below:

Using a 19mm wrench, turn the keeper nut counterclockwise to loosen the keeper nut.

Using a 8mm wrench, turn the adjustment hinge pin clockwise or counterclockwise to level the refrigerator door.

After leveling the door, turn the keeper nut clockwise to tighten it.

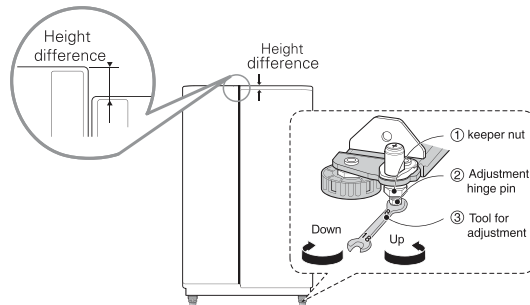

CAUTION

Do not over tighten the door adjustment screw. The hinge pin can be pulled out (adjustable range of height is a maximum of 5 cm).

After leveling the door height

Next

The refrigerator doors will close smoothly by heightening the front side by adjusting the height adjusting screw. If the doors do not close correctly, performance may be affected.

1. Wipe off all dust accumulated during shipping and clean your appliance thoroughly.
2. Install accessories such as the ice cube box, cover evaporating tray, etc., in their proper places. They are packed together to prevent possible damage during shipping.
3. Connect the power supply cord (or plug) to the outlet. Don't double up with other appliances on the same outlet.

Starting

When your refrigerator is first installed, allow it to stabilize at normal operating temperatures for 2-3 hours prior to filling it with fresh or frozen foods. If operation is interrupted, wait 5 minutes before restarting.

Adjusting the temperatures and functions

Refreshment Center
(Applicable to some models only)

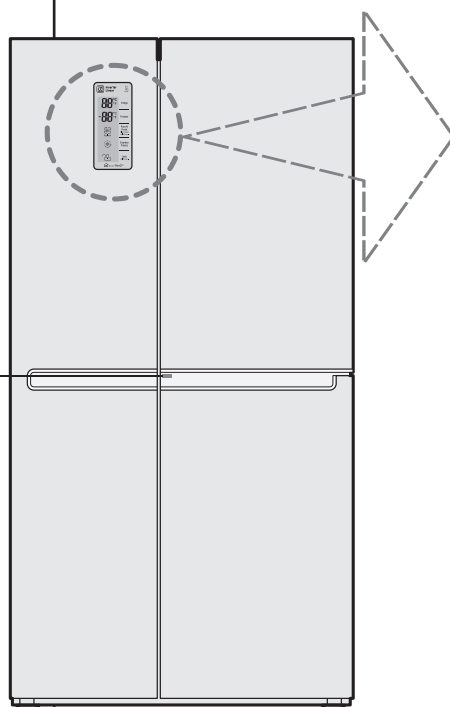

Function display board

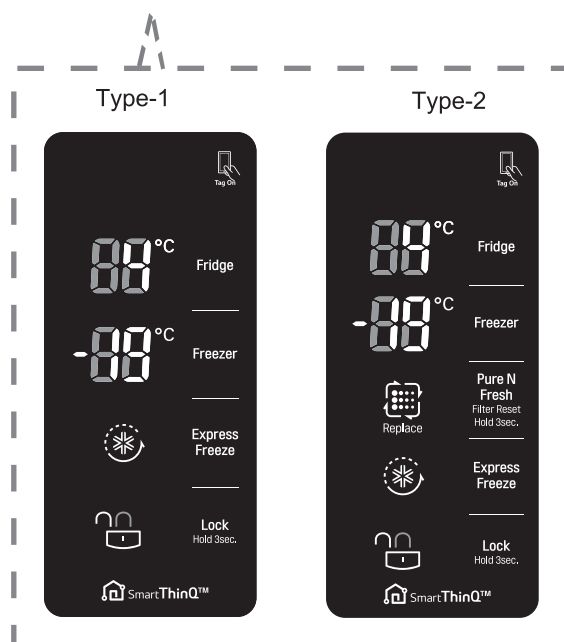

NOTE

- Your model may not include every option.

Note

Display Power Saving

The display will automatically turn off after 20 seconds for power saving.

How to adjust the temperature in the freezer compartment

You can adjust temperature of the freezer room and refrigerator room.

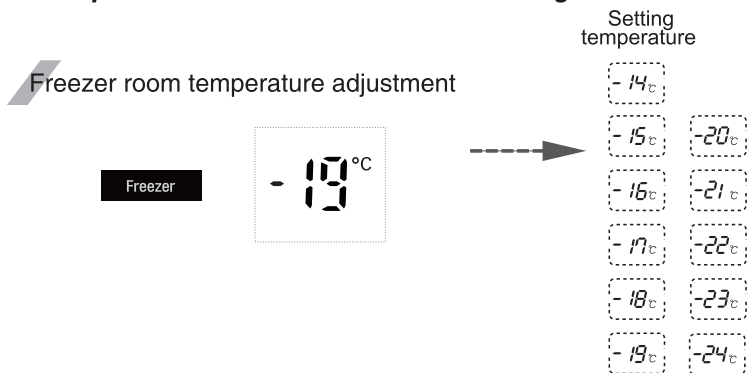

※ Whenever pressing **Freezer** button, setting is repeated in the order of (-19°C → -20°C → ... → -24°C → -14°C → ... → -19°C).

How to adjust the temperature in the refrigerator compartment

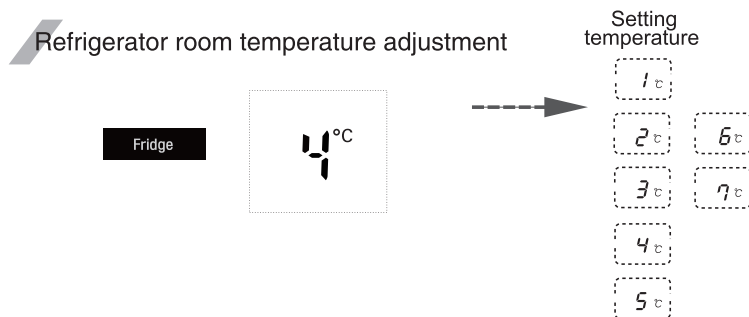

※ Whenever pressing **Fridge** button, setting is repeated in the order of (4°C → 3°C → 2°C → ... → 1°C → 7°C → 6°C → ... → 4°C).

- The actual inner temperature varies depending on the food status, as the indicated seeing temperature is a target temperature, not actual temperature within refrigerator.
- Refrigeration function is weak in the initial time, Please adjust temperature as above after using refrigerator for minimum 2-3 days.

Express freezer

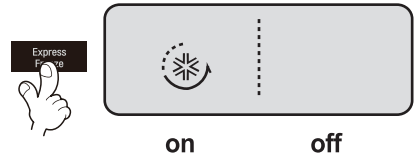

Please select this function for express freezer.

- "on" and "off" is repeated whenever pressing  button.
- The arrow mark graphic remains at the "on" status when selecting Special Refrigeration "on".
- When Quick-freeze is "ON", press the button again to turn it off, or after a period of time the Quick-freeze function will turn off automatically after completion.



Lock

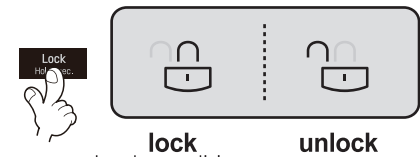

This button stops operation of different button.

- Locking or Release is repeated whenever the button is pressed more than 3 seconds.
- When you use the  button, you can not use any other button, until you unlock the unit. When you press the other button when the unit is locked, the  will flash 3 times to notify the current Lock condition.



Pure N Fresh (Optional)

When you need to clean the air please select this function.

- After normal usage for a year, the  displays indicating Pure N Fresh need to be replaced. Customers can replace it based on personal needs.
- After replacing Pure N Fresh or when replacement is not needed, press and hold the  button for more than 3 secs, the timer of the indicator starts again and the reminder is off.
- Water cannot be used for cleaning the filter as it may affect the efficiency. If the operation time exceed the validity time, it may affect deodorization functions.
- If you need to replace the Pure N Fresh, please contact local service center.

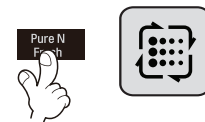

CAUTION

The other functions

Door open warning

- 3 times of warning sounds at the interval of 30 seconds if a minute passes with the door of refrigerator and the hombar door opened or completely closed.
- Please contact with the local service center if warning continue to sound even after closing the door.

Diagnosis (failure detection) function

- Diagnosis function automatically detects failure when failure is found in product during the use of refrigerator.
- If failure occurs at product, it does not operate though pressing any button and normal indication is not done. In this case, do not turn power off but immediately contact with the local service center. A lot of time are need for service engineer to detect the failed part if turning it off.

Ice making

Ice making Type-1

- Pour water into the ice making container. If you pour too much water, the ice cannot be split into cubes easily. Water droplets will fall down which make the ice cubes cling to each other.
- Rotate the ice splitting knob in the ice making compartment. The ice cubes will fall into the ice storing container.

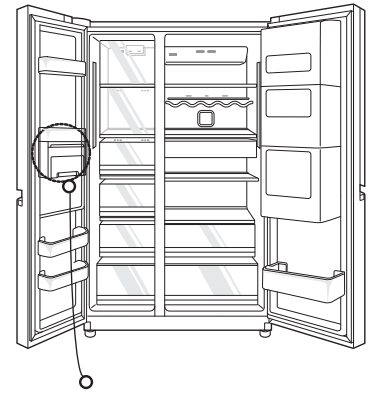

Ice making container

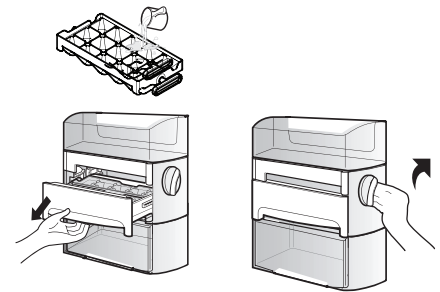

Note

- If you rotate the ice splitting knob before the ice is completely frozen, the remaining water will drop into ice storing container, which will make the ice cubes cling to each other.

Ice making Type-2

- To make ice cubes, fill the ice tray to the water level and place it in the freezer.
- To remove ice cubes, hold the tray at its ends and twist gently.

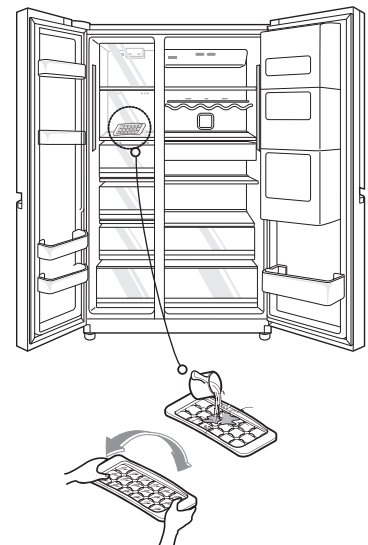

Tip

To remove ice cubes easily, run water on the tray before twisting.

Refreshment center (Applicable to some models only)

How to use the Home Bar

1. Press and hold the lever at the bottom left of the crisper until you hear a clicking sound.
 - With more storage space you can store more food.

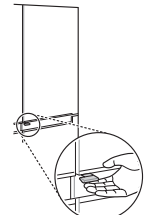

- With more storage space, you can store various types of food.

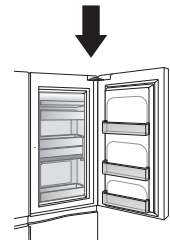

Shelf

How to use

You can store side dish or refrigerated food on the shelf with sufficient space in between the containers.



How to disassemble

1. Hold the rear part of the shelf slightly up and pull it forward.

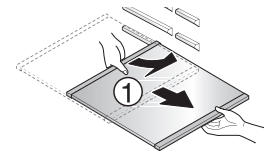

2. Lift the shelf slightly up after pulling it half way.

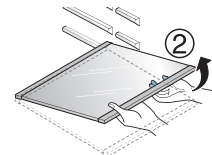

3. While holding the shelf slightly, tilt the shelf to pull it out.

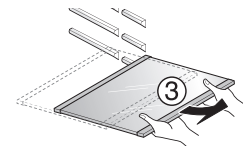

Two stars section ****** (Applicable to some models only)

- Two stars section means the space stored at -12°C~-18°C.
- Freezer foods for short-terms storage.

LED indicator (Freezer/Refrigerator)

- When the indicator is operating in refrigerator
- When the freezer/refrigerator door is opened, The built-in LED indicator will light up.
 - * This LED indicator will light up when the freezer/refrigerator or Home bar door is opened.
 - * This LED indicator can be used semi-permanently.

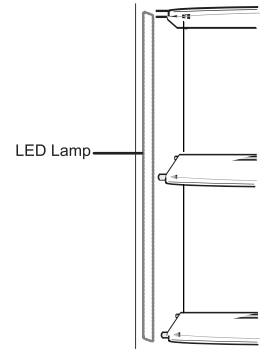

Pure N Fresh (Applicable to some models only)

How to use the Pure N Fresh

- Pure N Fresh is already installed on the refrigerator wall, so installation is not needed.
- Please use containers with tight lids to place spicy food. Otherwise the odor will be absorbed by other food.

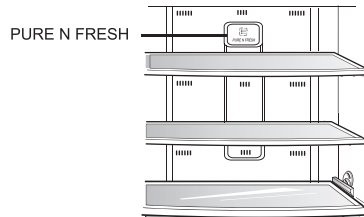

Disassembling and installing the Pure N Fresh

- Hold the case of Pure N Fresh, rotate it counterclockwise about 15 degrees as shown in (a). Take out Pure N Fresh from the case.
- Replace the new Filter into the case as shown in picture (b) (Note the direction of installation).
- Place the unit as shown in picture (c), insert and rotate it clockwise until you hear a clicking sound and the installation is finished.

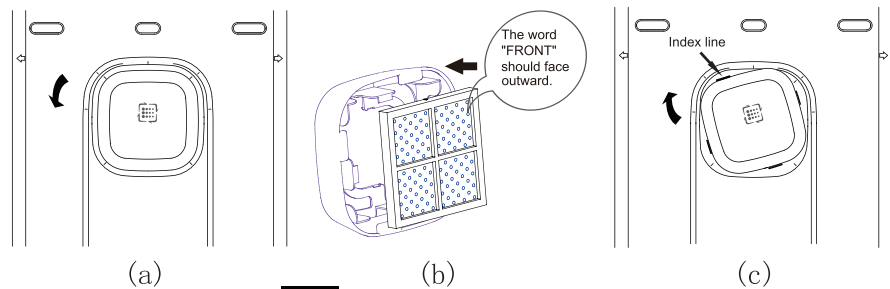

CAUTION

- If the display shows "  ", please contact local service center.

WARNING

- Do not place your fingers or foreign objects into the fan of the filter to avoid injury or launch accidentally.

Wine holder adjustment

Wine holder (Applicable to some models only)

Bottles can be stored laterally with this wine rack.

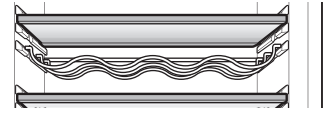

Egg box (Applicable to some models only)

You can move the egg box to wherever you want.

Type-1

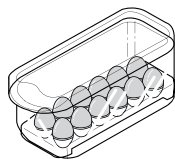

Type-2

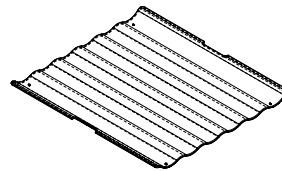

CAUTION

- Never use the egg box as an ice storage bin. It can be broken.
- Never store the egg box in the freezer compartment or fresh compartment.

Deodorizer (Applicable to some models only)

This system efficiently absorbs strong odors by using the optical catalyst. This system does not have any effect on stored food.

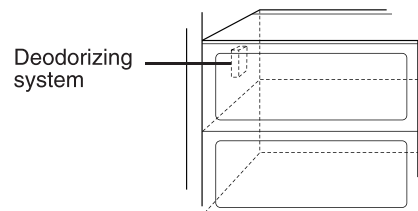

Freezer Compartment

If a large quantity of food is to be placed in the freezer compartment.

- The drawer of freezer compartment shall be taken out of the appliance and the food can be stacked directly on the drawer cover & bottom of freezer compartment .
- Freezer compartment provides drawer cover on default to maximize food storage capacity. And also the drawer is provided to convenient usage for watery meat or half-liquid state food.

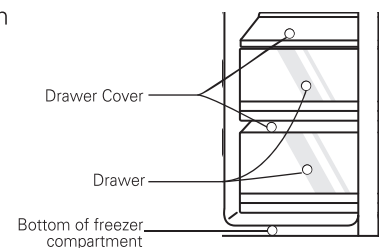

Location of foods

(Refer to identification of parts)

Wine holder

Store wine.



Freezer compartment shelf

Store various frozen foods such as meat, fish, ice cream, frozen snacks, etc..

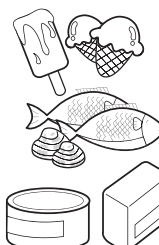

Freezer compartment door rack

- Store small packed frozen food.
- Temperature is likely to increase as door opens. So, do not store long-term food such as ice cream, etc..

Freezer compartment drawer

- Store meat, fish, chicken, etc.. after wrapping them with thin foil.
- Store dry.

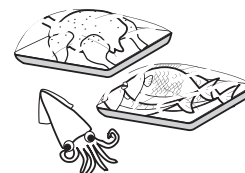

Milk product corner

Store milk products such as butter, cheese, etc..



Egg box

Place this egg box in the proper location.



Refreshment center

Store foods of frequent use such as beverage, etc..



Refrigerator compartment shelf

Store side dishes or other foods at a proper distance.



Refrigerator compartment door rack

Store small packed food or beverages such as milk, juice, beer, etc..

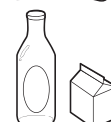

Vegetable drawer

Store vegetables or fruits.

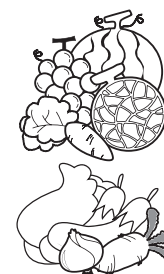

Storing foods

- Store fresh food in the refrigerator compartment. How food is frozen and thawed is an important factor in maintaining its freshness and flavor.
- Do not store food which goes bad easily at low temperatures, such as bananas, and melons.
- Allow hot food to cool prior to storing, placing hot food in the refrigerator could spoil other food, and lead to higher energy consumption.
- When storing the food, cover it with vinyl wrap or store in a container with a lid. This prevents moisture from evaporating, and helps food to keep its taste and nutrients.
- Do not block air vents with food. Smooth circulation of chilled air keeps refrigerator temperatures even.
- Do not open the door frequently. Opening the door lets warm air enter the refrigerator, and cause temperatures to rise.
- Never keep too much food in door rack because they may push against by inner racks so that the door cannot be fully closed.
- Do not store bottles in the freezer compartment - they may break when frozen.
- Do not refreeze food that has been thawed. This causes loss of taste and nutrient.
- When storing frozen food like ice cream for a long period, place it on the freezer shelf, not in the door rack.
- Do not touch the cold foods or containers- especially made of metallic -, with wet hands and place glass products in the freezer compartment.

Freezer compartment

CAUTION

- That's why you may have chilblains and they may be broken when their inner matters are frozen, causing personal injury.

Refrigerator compartment

- Avoid placing moist food in top refrigerator shelves, it could freeze from direct contact with chilled air.
- Always clean food prior to refrigeration. Vegetables and fruits should be washed and wiped, and packed food should be wiped, to prevent adjacent food from spoiling.
- When storing eggs in their storage rack or box, ensure that they are fresh, and always store them in an upright position, which keeps them fresh longer.

NOTE

- If you keep the refrigerator in a hot and humid place, frequent opening of the door or storing a lot of vegetables in it may cause dew to form which has no effect on its performance. Remove the dew with dust cloth free from care.

Energy-Saving Method

- Install the fridge in a shady, cool and well-ventilated place.
- Do not open and close the door frequently if not necessary.
- Please do not keep the door open for a long time, close door in the shortest time.
- Allow hot food to cool prior to storing.
- Too much food are not advised to be put in. Enough space should be kept for cool air circulating freely.
- Do not set the temperature of refrigerator lower than needed.
Do not put the food near the temperature sensor.
- Food need't store is not advised to be put in.
- Place the deep-frozen food for thawing intorefrigerator; they can be used for cooling the refrigerator. (Applicable to some models only)
- Clean up the back cover and anti-condensation pipe termly (once a year) to make sure heat exchange in gear. (Applicable to some models only)
- Do not block air vents with food. (Applicable to some models only)

How to dismantle parts

NOTE

- Dismantling is done in the reverse sequence of assembly.
Be sure to unplug the power plug before dismantling and assembly.
Never apply severe force to dismantle parts. Parts may be damaged.

Door rack and support

Lift the door rack holding both sides ① and pull it out to ② direction.

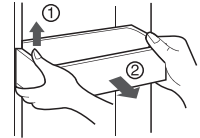

Ice maker (Optional)

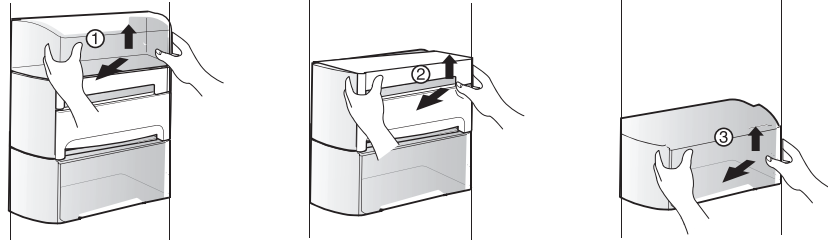

- Lift up (1), then pull the rack towards your body.
- Lift up (2), then pull the ice making container towards your body.
- Lift up (3), then pull the ice storing container towards your body.

When you do not use the ice making, you can take out the ice container, and use the ice storing container as a rack.

⚠ Note

- When you clean the ice maker, please do not put it into water or wash it with water. You should wipe it with wet towel and dry it before use. If moisture remains in the ice maker, the normal operation of ice maker may be affected.

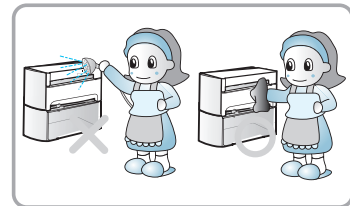

Disassembling the crisper (Optional)

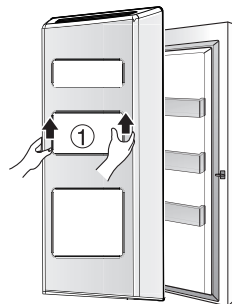

- Lift the crisper ① and remove it from the door.

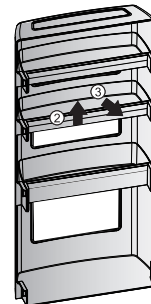

- After removal, raise the ② and pull out the ③ from the crisper.

General information

Vacation time

During average length vacations, you will probably find it best to leave the refrigerator in operation. Place freezable items in freezer for longer life.

When you plan not to operate, remove all food, disconnect the power cord, clean the interior thoroughly, and leave each door OPEN to prevent odor formation.

Power failure

Most power failures that are corrected in an hour or two will not affect your refrigerator temperatures.

However, you should minimize the number of door openings while the power is off.

If you move

Remove or securely fasten down all loose items inside the refrigerator.

To avoid damaging the height adjusting screws, turn them all the way into the base.

Anti condensation pipe

The outside wall of the refrigerator cabinet may sometimes get warm, especially just after installation.

Don't be alarmed. This is due to the anti-condensation pipe, which pumps hot refrigerator to prevent "sweating" on the outer cabinet wall.

Cleaning

It is important that your refrigerator be kept clean to prevent undesirable odors. Spilled food should be wiped up immediately, since it may acidify and stain plastic surfaces if allowed to settle.

Exterior

Use a lukewarm solution of mild soap or detergent to clean the durable finish of your refrigerator.

Wipe with a clean damp cloth and then dry.

For products with a stainless steel exterior, use a clean sponge or soft cloth and a mild Detergent in warm water. Do not use abrasive or harsh cleaners. Dry thoroughly with a Soft cloth. Do not use appliance wax, bleach, or other products containing chlorine on stainless steel.

Interior

Regular cleaning is recommended. Wash all compartments a baking soda solution or a mild detergent and warm water. Rinse and dry.

After cleaning

Please verify that the power cord is not damaged, power plug is not overheated, or power plug is well inserted into the power consent.

WARNING

Always remove power cord from the wall outlet prior to cleaning in the vicinity of electrical parts (lamps, switches, controls, etc.).

Wipe up excess moisture with a sponge or cloth to prevent water or liquid from getting into any electrical part and causing an electric shock.

Never use metallic scouring pads, brushes, coarse abrasive cleaners, strong alkaline solutions, flammable or toxic cleaning liquids on any surface.

Do not touch frozen surfaces with wet or damp hands, because damp object will stick or adhere to extremely cold surfaces.

Trouble shooting

Before calling for service, review this list. It may save you both time and expense. This list includes common occurrences that are not the result of defective workmanship or materials in this appliance.

Occurrence	Possible cause	Solution
Runing of refrigerator		
Refrigerator compressor does not run.	Refrigerator control is off.	Set refrigerator control. See setting the controls.
	Refrigerator is in defrost cycle.	This is normal for a fully automatic defrosting refrigerator. The defrost cycle occurs periodically.
	Plug at wall outlet is disconnected.	Make sure plug is tightly pushed into outlet.
	Power outage. Check house lights.	Call local electric company.
Refrigerator runs too much or too long	Refrigerator is larger than the previous one you owned.	This is normal. Larger, more efficient units run longer in these conditions.
	Room or outside weather is hot.	It is normal for the refrigerator to work longer under these conditions.
	Refrigerator has recently been disconnected for a period of time.	It takes some hours for the refrigerator to cool down completely.
	Large amounts of warm or hot food may have been stored recently.	Warm food will cause the refrigerator to run longer until the desired temperature is reached.
	Doors are opened too frequently or too long.	Warm air entering the refrigerator causes it to run longer. Open the door less often.
	Refrigerator or freezer door may be slightly open.	Make sure the refrigerator is level. Keep food and containers from blocking door. See problem section. OPENING/CLOSING of doors.
	Refrigerator control is set too cold.	Set the refrigerator control to a warmer setting until the refrigerator temperature is satisfactory.
	Refrigerator or freezer gasket is dirty, worn, cracked, or poorly fitted.	Clean or change gasket. Leaks in the door seal will cause refrigerator to run longer in order to maintain desired temperatures.
Thermostat is keeping the refrigerator at a constant temperature.	This is normal. Refrigerator goes on and off to keep the temperature constant.	

Occurrence	Possible cause	Solution
Refrigerator compressor does not run.	Thermostat is keeping the refrigerator at a constant temperature.	This is normal. The refrigerator goes on and off to keep the temperature constant.
Temperatures are too cold		
Temperature in the freezer is too cold but the refrigerator temperature is satisfactory.	Freezer control is set too cold	Set the freezer control to a warmer setting until the freezer temperature is satisfactory.
Temperature in the refrigerator is too cold and the freezer temperature is satisfactory.	Refrigerator control is set too cold.	Set the refrigerator control to a warmer setting
Food stored in drawers freezes.	Refrigerator control is set too cold.	See above solution.
Meat stored in fresh meat drawer freezes.	Meat should be stored at a temperature just below the freezing point of water (32° F, 0° C) for maximum fresh storage time.	It is normal for ice crystals to form due to the moisture content of meat.
Temperatures are too warm		
Temperatures in the refrigerator or freezer are too warm.	Freezer control is set too warm.	Set the freezer or refrigerator control to a colder setting until the freezer or refrigerator temperature is satisfactory.
	Refrigerator control is set too warm. Refrigerator control has some effect on freezer temperature.	Set the freezer or refrigerator control to a colder setting until the freezer or refrigerator temperature is satisfactory.
	Doors are opened too frequently or too long.	Warm air enters the refrigerator/ freezer whenever the door is opened. Open the door less often.
	Door is slightly open.	Close the door completely.
	Large amounts of warm or hot food may have been stored recently.	Wait until the refrigerator or freezer has a chance to reach its selected temperature.
	Refrigerator has recently been disconnected for a period of time.	A refrigerator requires some hours to cool down completely.
Temperature in the refrigerator is too warm but the freezer temperature is satisfactory.	Refrigerator control is set too warm.	Set the refrigerator control to a colder setting.

Occurrence	Possible cause	Solution
Sound and noise		
Louder sound levels when refrigerator is on.	Today's refrigerators have increased storage capacity and maintain more even temperatures.	It is normal for sound levels to be higher.
Louder sound levels when compressor comes on.	Refrigerator operates at higher pressures during the start of the ON cycle.	This is normal. The sound will level off as the refrigerator continues to run.
Vibrating or rattling noise.	Floor is uneven or weak. Refrigerator rocks on the floor when it is moved slightly.	Be sure floor is level and solid and can adequately support refrigerator.
	Items placed on the top of the refrigerator are vibrating.	Remove items.
	Dishes are vibrating on the shelves in the refrigerator.	It is normal for dishes to vibrate slightly. Move dishes slightly. Make sure refrigerator is level and firmly set on floor.
	Refrigerator is touching wall or cabinets.	Move refrigerator so that it does not touch the wall or refrigerator.
Water/Moisture /Ice inside refrigerator		
Moisture collects on the inside walls of the refrigerator.	The weather is hot and humid which increases the rate of frost buildup and internal sweating.	This is normal.
	Door is slightly open.	See problem section opening/closing of doors.
	Door is opened too often or too long.	Open the door less often.
Water/Moisture /Ice outside refrigerator		
Moisture forms on the outside of the refrigerator or between doors.	Weather is humid.	This is normal in humid weather. When humidity is lower, the moisture should disappear.
	Door is slightly open, causing cold air from the inside the refrigerator to meet warm air from the outside.	This time, close the door completely.

Occurrence	Possible cause	Solution	
Odors in refrigerator	Interior needs to be cleaned.	Clean interior with sponge, warm water and baking soda.	
	Food with strong odor is in the refrigerator.	Cover food completely.	
	Some containers and wrapping materials produce odors.	Use a different container or brand of wrapping materials.	
Opening/Closing of doors/Drawers			
	Door(s) will not close.	Food package is keeping door open.	Move packages that keep door from closing.
	Door(s) will not close.	Door was closed too hard, causing other door to open slightly.	Close both doors gently.
		Refrigerator is not level. It rocks on the floor when it is moved slightly.	Adjust the height adjusting screw.
		Floor is uneven or weak. Refrigerator rocks on the floor when it is moved slightly.	Be sure floor is level and can adequately support refrigerator. Contact carpenter to correct sagging or sloping floor.
	Refrigerator is touching wall or cabinets.	Move refrigerator..	
Drawers are difficult to move.	Food is touching shelf on top of the drawer	Keep less food in drawer.	
	Track that drawer slides on is dirty.	Clean drawer and track.	



DISPOSAL OF YOUR OLD APPLIANCE

1. This crossed-out wheeled bin symbol indicates that waste electrical and electronic products (WEEE) should be disposed of separately from the municipal waste stream.
2. Old electrical products can contain hazardous substances so correct disposal of your old appliance will help prevent potential negative consequences for the environment and human health. Your old appliance may contain reusable parts that could be used to repair other products, and other valuable materials that can be recycled to conserve limited resources.
3. You can take your appliance either to the shop where you purchased the product, or contact your local government waste office for details of your nearest authorised WEEE collection point. For the most up to date information for your country please see www.lg.com/global/recycling

It is Normal...

The following occurrences are normal.

	Occurrence	Solution
Noise	When you hear "Tak" or "Took" sound	This is the sound of various parts expanding/contracting or various control devices operating depending on the temperature change within the refrigerator.
	When you hear "Deureureuk~", "Dulkuk" or "Woong" sound	This is the count of compressor or fan operating when the operation of the refrigerator is starting or ending. This is the same phenomenon of the sound generated when starting or turning off the engine of a car.
	When you hear "Kureureuk" sound of water flowing	This is the sound of refrigerant changing the condition in the freezer/fridge. When the liquid changes to gas, you will hear the sound of water flowing and when gas changes to liquid, you will hear the "Kureureuk" sound.
	When you hear the sound of wind such as "Shoo~" or "Shik" right after you close the door	This is the sound generated when the internal pressure is temporarily lowered when the warm air entered through the fridge or freezer is cooled fast.
	When you hear the vibrating sound	If the refrigerator is installed on wooden floor or wooden wall, or if the refrigerator is not leveled properly, the sound can be loud from the vibration.
	When you hear a loud sound after installing the product for the first time	When you operate the refrigerator for the first time, the refrigerator will operate at high speed to cool fast and the sound can seem louder. When the internal temperature falls below a certain level, the noise will subside.
Door open	When the door is slightly opened after closing the door	Depending on the force or speed of closing the fridge or freezer door, the door can open slightly and then get closed. Be careful not to close the door too hard.
Icing/ Dew drops	When there is icing or dew drops formed on the inner or outer side of the refrigerator	When external air flows into the cool inner surface of the refrigerator, icing/dew drops can be formed. Especially, this will happen more easily when you open and close the refrigerator door more frequently. Also if the humidity of the installed location is high or during the rainy season or on a rainy day, dew drops can form on the outer side of the refrigerator. This is a natural phenomenon that occurs during the humid weather. Wipe the water drops with a dry cloth.
Temperature	When the front side of the refrigerator is warm	Heat pipes are installed around the front part of the refrigerator and on the divider of the freezer and fridge to prevent the dew drops from forming. The refrigerator may feel warmer after the installation or during the hot summer, but this is not a problem and you can be rest assured.

Smart Diagnosis

(Applicable to some models only)



Should you experience any problems with your refrigerator, it has the capability of transmitting data via your telephone to the LG service center. This gives you the capability of speaking directly to our trained specialists. The specialist records the data transmitted from your machine and uses it to analyze the issue, providing a fast and effective diagnosis.

If you experience problems with your refrigerator, call to the LG service center. Only use the Smart Diagnosis feature when instructed to do so by the LG call center agent. The transmission sounds that you will hear are normal and sound similar to a fax machine.

Smart Diagnosis cannot be activated unless your refrigerator is connected to power. If your refrigerator is unable to turn on, then troubleshooting must be done without using Smart Diagnosis.

Smart Diagnosis™ Through the Customer Information Center

First, call to the LG service center. Only use the Smart Diagnosis feature when instructed to do so by the LG call center agent.

1. Lock the display. To lock the display, press and hold the Lock button for three seconds. (If the display has been locked for over five minutes, you must deactivate the lock and then reactivate it.)



2. Open the right refrigerator door.

3. Hold the mouthpiece of your phone in front of the speaker that is located on the right hinge of the refrigerator door, when instructed to do so by the call center.

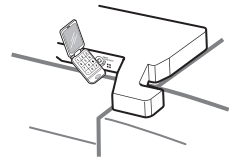

4. Press and hold the Freezer Temperature button for three seconds while continuing to hold your phone to the speaker.



5. After you hear three beeps, release the Freezer Temperature button

6. Keep the phone in place until the tone transmission has finished. This takes about 3 seconds, and the display will count down the time. Once the countdown is over and the tones have stopped, resume your conversation with the specialist, who will then be able to assist you in using the information transmitted for analysis.

Smart Diagnosis™ Using the Smart Phone

1. Download the LG Smart ThinQ application on a smart phone.
2. Open the LG Smart ThinQ application on the smart phone. Create an account and sign in.
3. Select the refrigerator in dashboard.
4. Select the **Smart Diagnosis**, then start and tag on it.

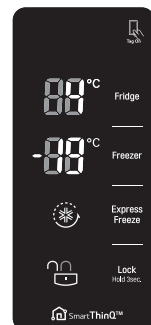

Using Smart Diagnosis

NOTE

- If the diagnosis is failed many times, then use the follow instructions continue.
5. Select the **Audible Diagnosis**.
 6. Place the mouthpiece of the smart phone close to the Smart Diagnosis™ icon.

NOTE

- For best results, do not move the phone while the tones are being transmitted.
- If the call center agent is not able to get an accurate recording of the data, you may be asked to try again.
- Call quality differences by region may affect the function.
- Use the home telephone for better communication performance, resulting in better service.
- Bad call quality may result in poor data transmission from your phone to the machine, which could cause Smart Diagnosis to not work properly.

ADDRESS

Country	Office Address
Austria	LG Electronics Austria GmbH Office Campus Gasometer Guglgasse 15 / 4a / Ground Floor A-1110 Vienna, Austria
Netherlands	LG Electronics Benelux Sales B.V. Krijgsman 1, 1186 DM Amstelveen, The Netherlands
Czech Rep.	LG Electronics CZ, s.r.o. (9 floor) Českomoravská 2420/15, 190 93 Praha 9 Czech Republic
Germany	LG ELECTRONICS Deutschland GmbH Berliner Str. 93, D - 40880 Ratingen
Spain	LG Electronics Spain C/ Chile Nº 1. CP. 28230 Las Rozas MADRID, SPAIN
Greece	LG ELECTRONICS HELLAS S.A. 1 Ethnarhou Makariou str., Delta Paleo Faliro, GR17501, Paleo Faliro, Greece
Italy	LG Electronics Italia Spa - Via Aldo Rossi 4 - 20149 Milano Tel: +39 02.51.80.1.360 - Mobile: +39 335.1025.343
Latvia	LG ELECTRONICS LATVIA., LTD. Gredu str.4a, Riga LV1019, Latvia
Hungary	LG Electronics Magyar Kft. H-1097 Budapest Könyves Kálmán krt. 3/a Hungary
Poland	LG Electronics Polska Sp. z o.o. ul.Wołoska 22 02-675 Warszawa
Portugal	LG ELECTRONICS PORTUGAL S.A Quinta da Fonte - Edifício D. Amélia, Rua Victor Câmara 2, Piso 2, 2770-229 Paço de Arcos Portugal
Romania	19-21 Bucuresti-Ploiesti Street, Baneasa Business Center, 5th Floor, District 1, Bucharest
Sweden	LG ELECTRONICS NORDIC AB Esbogatan 18, SE-164 94, Akalla, Kista, Sweden



LG Customer Information Center

- | | |
|---|---|
| ☎ LG SERVICE : (ITALIA) 199600099 | ☎ LG SERVICE : (SVERIGE) 0770-54-54-54
(DANMARK) 8088-5758
(SUOMI) 0800-0-54-54
(NORSK) 800-187-40 |
| ☎ LG SERVICE : (AUSTRIA) 0810-144-131
(SLOVENIA) 080-543-543
(SWITZERLAND) 0848-543-543 | ☎ LG SERVICE : (ČESKÝ) 420-810 555 810 |
| ☎ LG SERVICE : (DEUTSCHLAND) 01806 115411 | ☎ LG SERVICE : (SIOVENSKÁ) 421-850 111 154 |
| ☎ LG SERVICE : (ΕΛΛΑΣ) 801-11-200-900-210 4800564 | ☎ LG SERVICE : (POLSKA) 0-801-54-54-54 |
| ☎ LG SERVICE : (NEDERLAND) 0900-543-5454 / 036-5377780
(BELGIUM) 015-200-255
(LUXEMBOURG) 32-15-200-255 | ☎ LG SERVICE : (ROMÂNĂ) 40-31-2283542 |
| ☎ LG SERVICE : (PORTUGAL) 808-78-5454 | ☎ LG SERVICE : (MAGYARORSZÁG) 06-40-545454 |
| ☎ LG SERVICE : (ESPAÑA) 963-050-500 | ☎ LG SERVICE : (HRVATSKA) (01)55-3-55-54 |
| | ☎ LG SERVICE : (БЪЛГАРСКИ) 07001 54 54 |
| | ☎ LG SERVICE : (Srbija) 011-3630500 |

Register your product Online!

www.lg.com