



ring

Stick Up Cam
Battery



1. Charge and insert the battery.

Charge the provided battery.

First, fully charge the battery by plugging it into a USB port using the provided orange cable.

The battery is fully charged when just one LED is lit.

 = Charging  = Charged

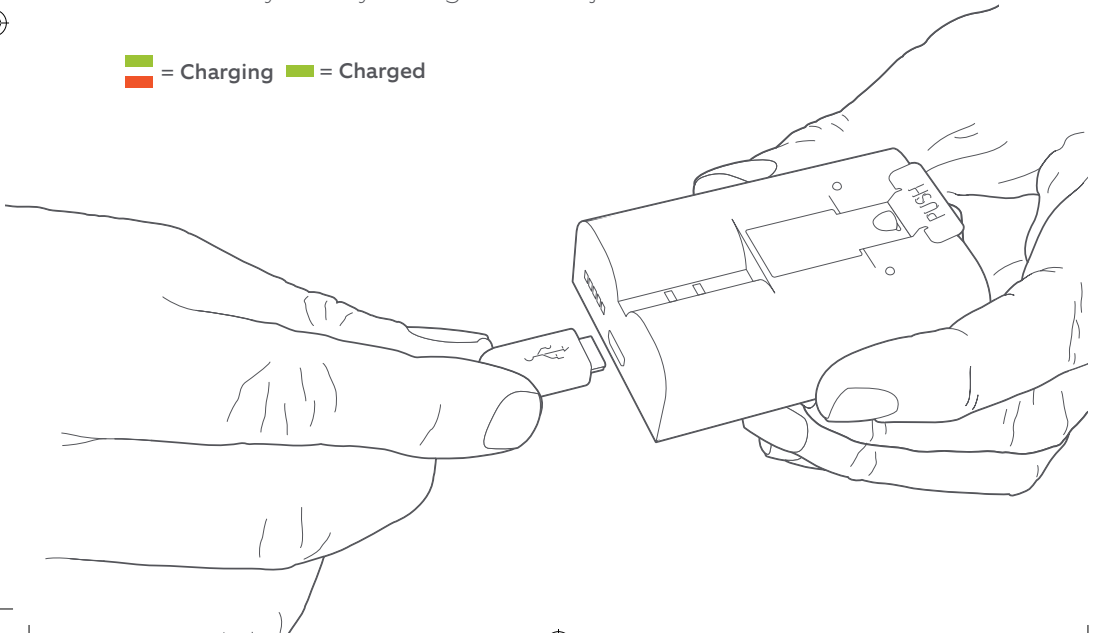



Remove the battery cover.

Twist the battery cover counterclockwise to unlock, then remove it from your Stick Up Cam.

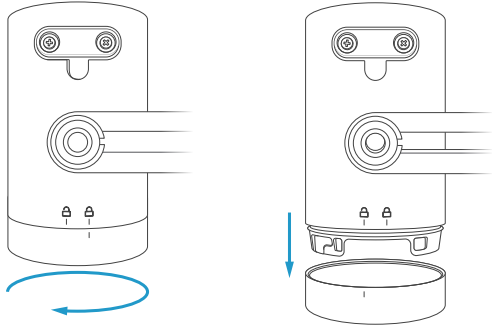

Insert the battery

Insert the charged battery into the bottom of your Stick Up Cam until it clicks into place.

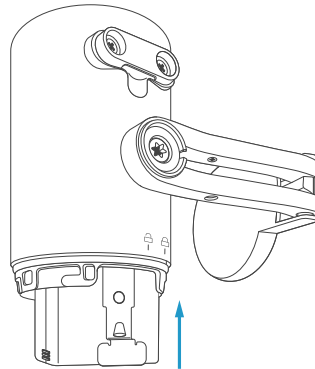



2. Set up your Stick Up Cam in the Ring app.

Download the Ring app.

The app walks you through setting up and managing your Stick Up Cam.

Search for “Ring” in one of the app stores below, or visit: ring.com/app



Grab your Wi-Fi password.

You'll need it to set up your Stick Up Cam.
Write it down below so it's handy when you need it:

Set up your Stick Up Cam in the Ring app.

In the Ring app, select **Set Up a Device** and follow the in-app instructions.

Try it out!

After setup, tap the Live View button in the Ring app to see live video from your Stick Up Cam.

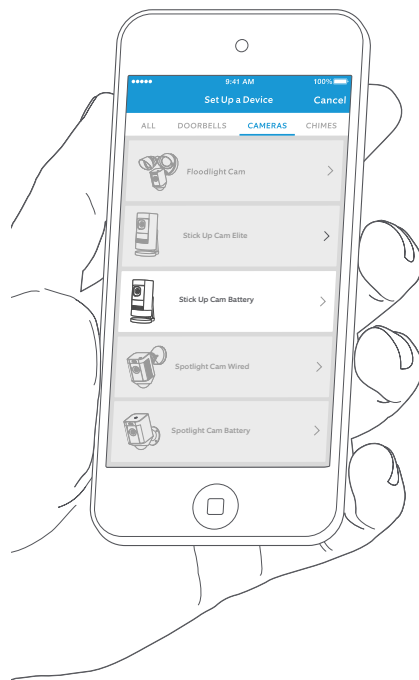

Blue light flashing?

If the light on the front of your Stick Up Cam is flashing after setup, it's updating its software.

Do not remove the battery from your Stick Up Cam while the light is flashing!



3. Install your Stick Up Cam Battery.

Choose a location.

Stick Up Cam is happy just about anywhere, indoors or out. It comes ready to sit on a flat surface like a table or shelf, but can also be mounted to a wall or ceiling.



Just choose a spot where it can provide the view you want.



Table or shelf



Mounted on a wall



Mounted on a ceiling



How to use Stick Up Cam on a table or shelf:



Your Stick Up Cam comes ready to place on a table or shelf. If desired, insert the provided security screw into the base, and tighten with the star-shaped end of the screwdriver bit.

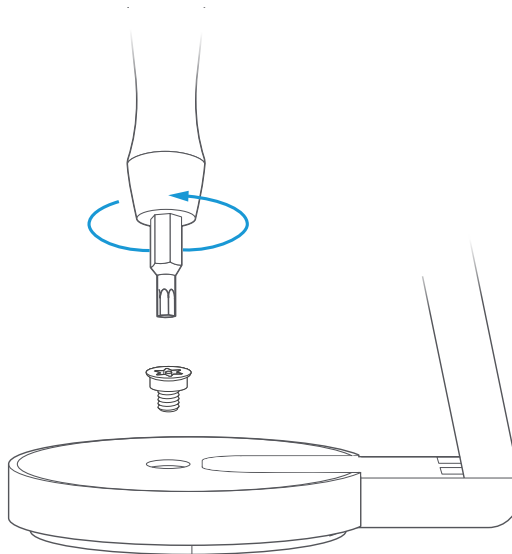

How to install Stick Up Cam on a wall:



Remove the plastic cover and rubber pad from the base.

You'll put the cover back on once you've mounted your Stick Up Cam.

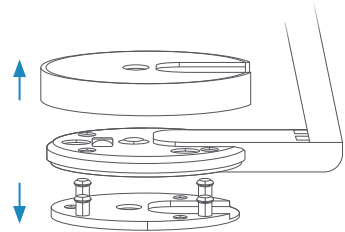

Flip the base to the rear.

The base of the stand is hinged. Before wall-mounting, flip the base down and behind your Stick Up Cam.

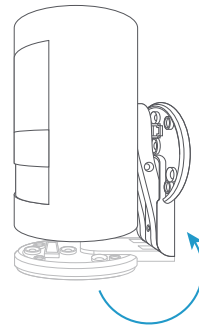
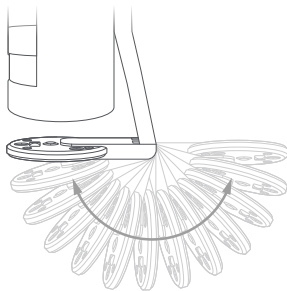



Push the rubber pad back into the base.

The rubber pad should sit between your wall and the base of your Stick Up Cam.

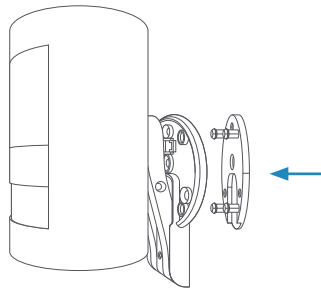

Drive the screws.

Hold the round part of the base against your wall, rubber-side down. Use the integrated level to ensure it's straight.

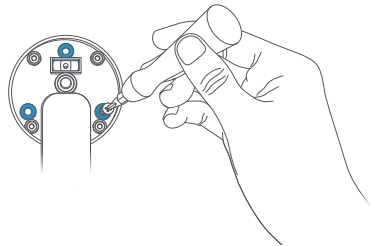

Then mount it with the included screws.

Snap the cover back onto the base.

Then, secure it with the included base security screw, using the star-shaped end of the screwdriver bit.

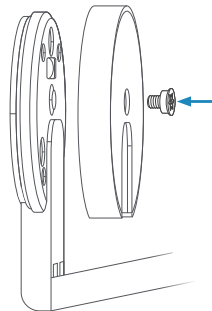

How to install Stick Up Cam on a ceiling:



Remove the plastic cover from the base.

You'll put the cover back on once you've mounted your Stick Up Cam.

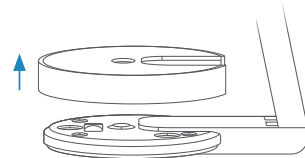

Rotate the stand above the camera:

The whole stand can rotate on its axis. Before ceiling-mounting, rotate the stand 180 degrees so the base is positioned above your Stick Up Cam.

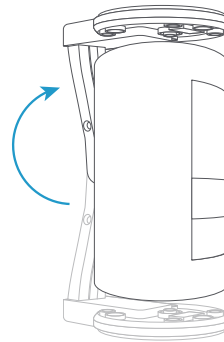
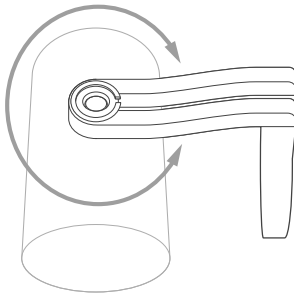



Drive the screws.

Hold the round part of the base against your ceiling, rubber-side down. Then mount it with the included screws.

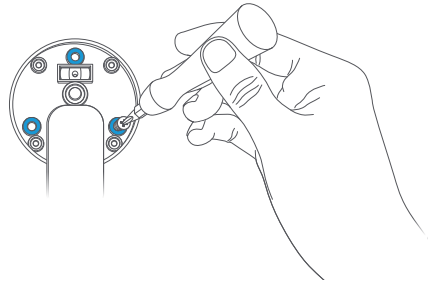

Snap the cover back onto the base.

Then, secure it with the included security screw, using the star-shaped end of the screwdriver bit.

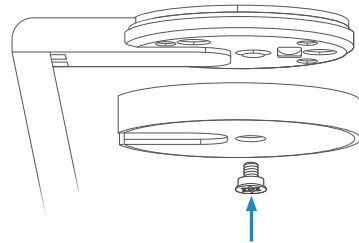

Base Cover
Security Screw

Final steps for all mounting styles:



Attach the battery cover.

Line up the “open lock” symbol on the rear of your Stick Up Cam with the line on the battery cover. Then push the cover on and twist clockwise to lock it in place.

Now your Stick Up Cam is installed and ready to protect you.

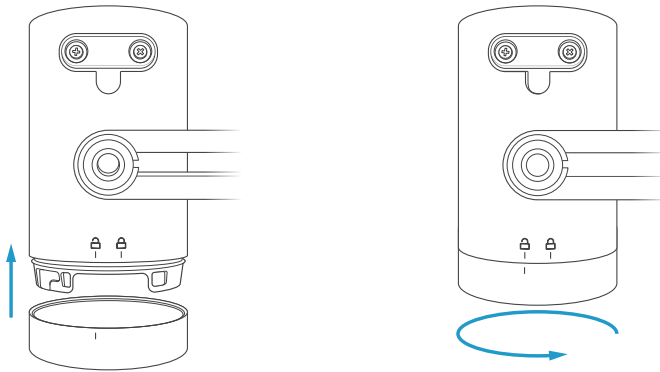

If desired, add the battery security screw.

By default, the battery cover can be easily removed for battery charging. However, if you want to secure it, add the included security screw.

To do this, pull the rubber plug out of the cover and insert the security screw. Finally, tighten it with the star-shaped end of the screwdriver bit.

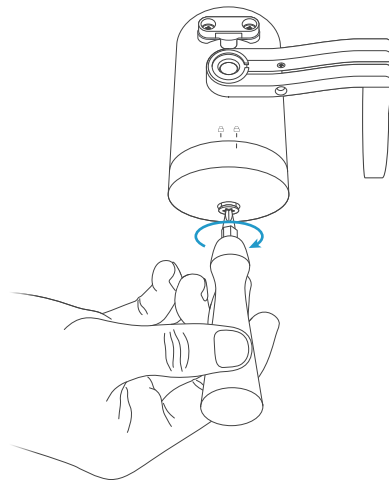
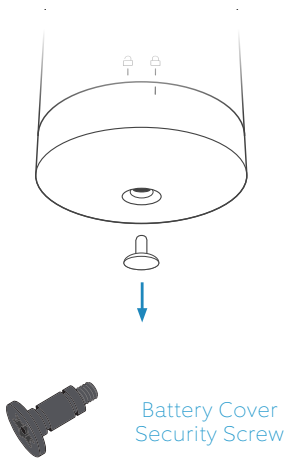

4. If you have a Ring Solar Panel...

Ring Solar Panel charges the battery in your Stick Up Cam whenever the sun is shining. To purchase your own, visit:



<https://shop.ring.com/products/solar-panel>

Mount your Ring Solar Panel.

Follow the Ring Solar Panel instructions to mount the panel to your home and route its power cable to your Stick Up Cam.

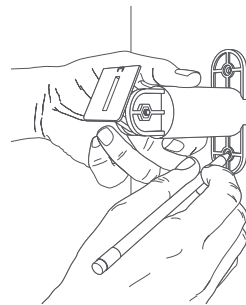



Remove the rubber plug.

Pull the round plug straight out of the power port to remove.

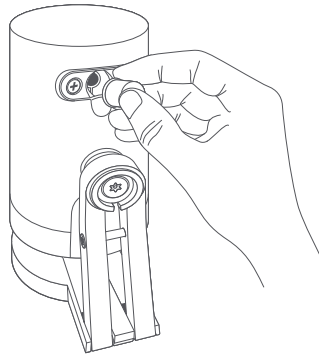

Plug in your Ring Solar Panel.

The power cable from your Ring Solar Panel may come with a round plug, or it may have a plug with screw tabs. The style of plug determines how you'll hook it up.

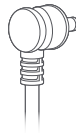

Round Plug

Insert it firmly into the power port, and you're done!

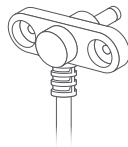

Screw Tab Plug

See page 16 for instructions.

How to connect a Ring Solar Panel with a screw tab power plug:

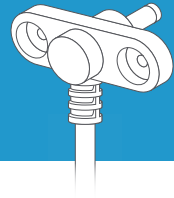

Remove the two screws next to the power port.

Be sure to save them, as you'll need them to secure the power plug later.

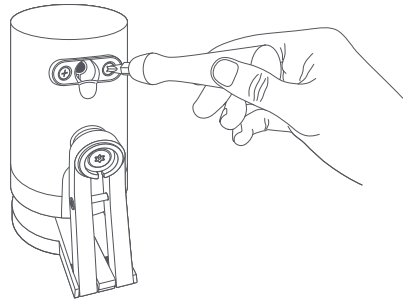

Remove the two rubber spacers.

If necessary, you can use the included screwdriver to gently pry them out.

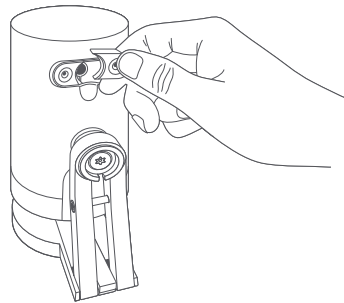

Insert the power plug.

In most cases, the trailing cable should point down.

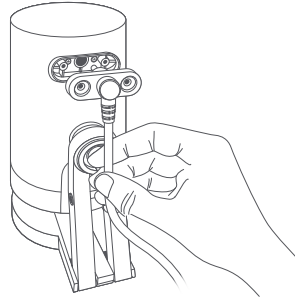

Secure the plug.

Be sure to use the screws you removed in the first step. Using any other screws may damage your Stick Up Cam.

That's it! You're done.

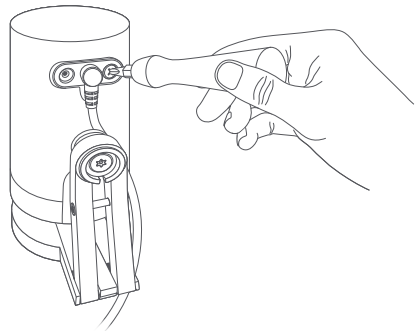



5. Need a little setup help?





If your in-app setup doesn't go as planned, try these tips:

Get your Wi-Fi password just right.

The most common setup issues come from entering the wrong Wi-Fi password. These passwords are case-sensitive, and every little error counts.

Reboot your router.

If you entered the right password but you're having no luck, try turning your Wi-Fi router off, wait 30 seconds, then turn it back on.

Then, begin setup again in the Ring app.



For additional help, visit: ring.com/help

Or give us a call...

US 1 800 656 1918

Canada 1 855 300 7289

Worldwide +1 310 929 7085

For a list of all our customer support numbers, visit:
ring.com/callus



To review your warranty coverage, please visit www.ring.com/warranty.

Patents: www.ring.com/patents

© 2019 Ring LLC or its affiliates.

RING, ALWAYS HOME, and all related logos are trademarks of Ring LLC or its affiliates.

Last updated: 02/14/19

