



40571





Stiamo passando dagli imballaggi di plastica a quelli basati su carta. Ecco perché potrete trovare un mix di carta e di plastica nelle nostre confezioni!

Estamos sustituyendo las bolsas de plástico por bolsas con base de papel. ¡Por eso, puede que encuentres una mezcla de papel y de plástico en nuestras cajas!

Estamos a substituir as nossas embalagens de plástico por embalagens à base de papel. Por isso poderá encontrar um misto de papel e plástico nas nossas caixas!

Átállunk a műanyagról a papír alapú csomagolásra. Ezért előfordulhat, hogy a dobozainkban papír és műanyag zacskót egyaránt találsz!

We're switching from plastic to paper-based packaging. That's why you might find a mix of paper and plastic in our boxes!

Wir stellen von Kunststoffverpackungen auf Verpackungen auf Papierbasis um. Möglicherweise findest du deshalb sowohl Papier als auch Kunststoff in unseren Boxen!

Nous abandonnons progressivement les emballages en plastique au profit d'emballages à base de papier. Il est donc possible que vous trouviez à la fois du papier et du plastique dans nos boîtes !

Mēs pārejam no plastmasas iepakojuma uz iepakojumu, kurā izmantots papīrs. Tāpēc mūsu kārbās var būt gan papīra, gan plastmasas daļas.

Trecem de la ambalajele din material plastic la ambalaje pe bază de hârtie. Iată de ce s-ar putea să găsești un amestec de hârtie și material plastic în cutiile noastre!

我们正在从塑料包装向纸基包装过渡。这就是为什么你可能会发现我们的包装盒中同时出现塑料和纸质材料！

**LEGO.com/sustainable-packaging**

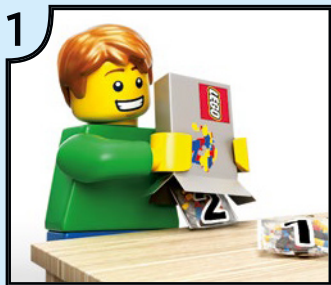

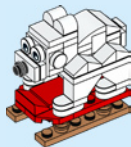
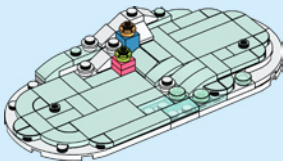
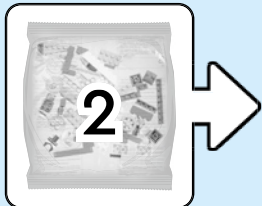



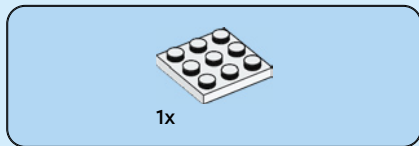
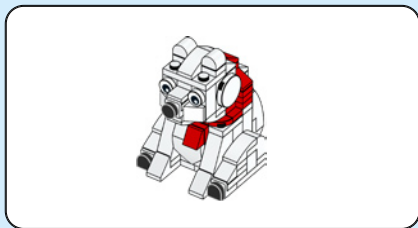

1

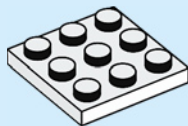

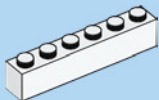

1x

2

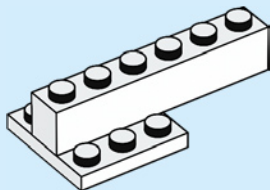

1x

3

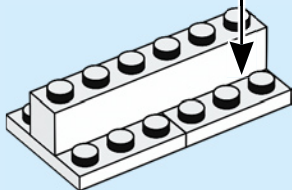
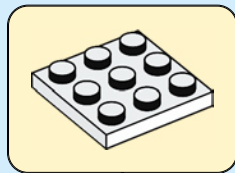



2x



2x

4

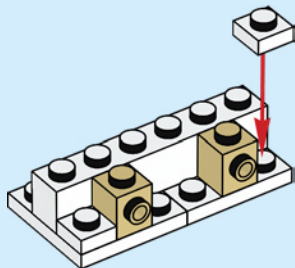

1x



2x

5

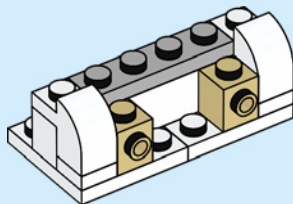

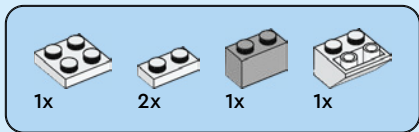

6

1

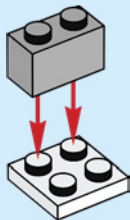

2

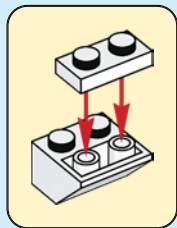
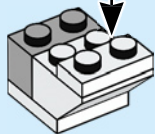

3

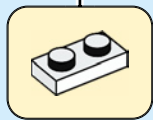
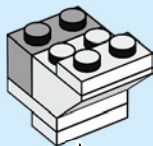

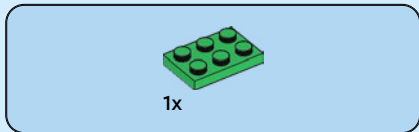
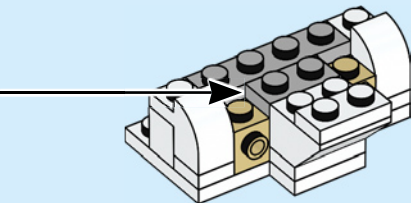

7

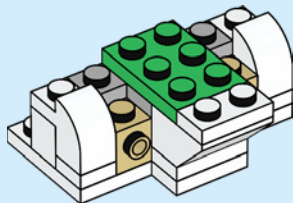



1x

8

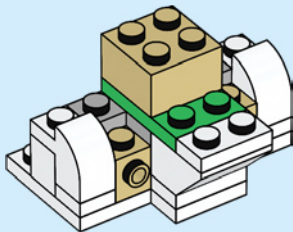

2x

9

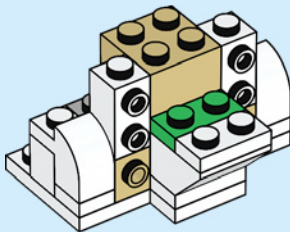



2x

10

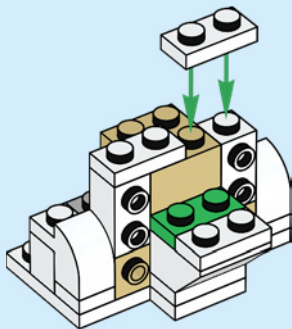

2x

11

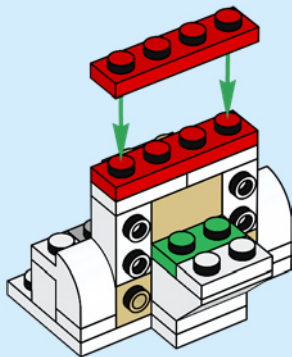



2x



2x

# 12



2x

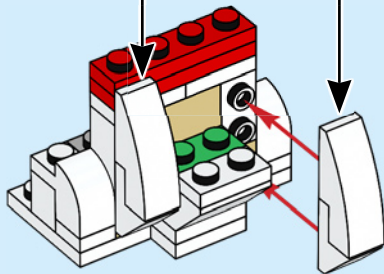





2x

13

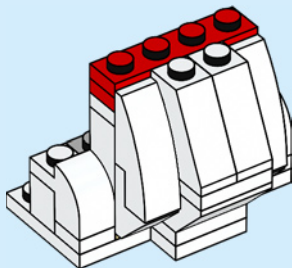

1x



2x

14

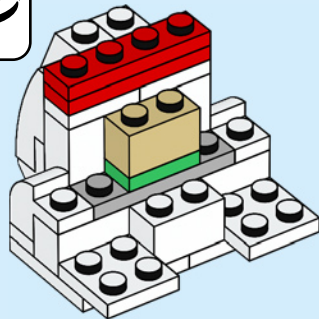



4x

15

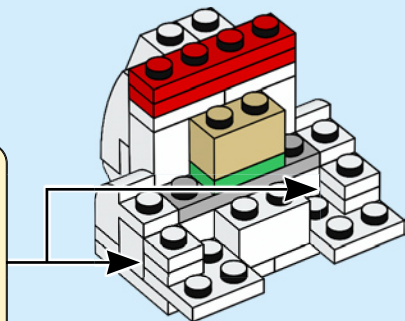
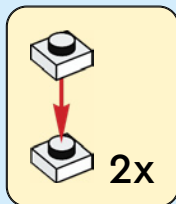



2x



2x

# 16

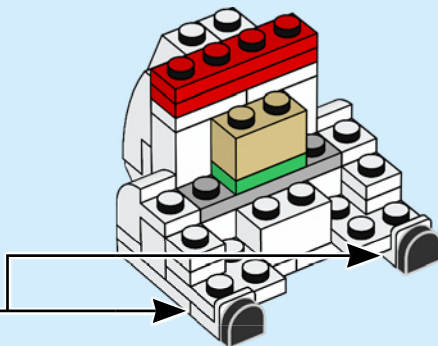
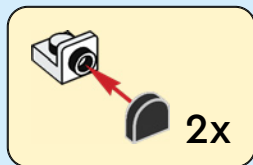



2x

17

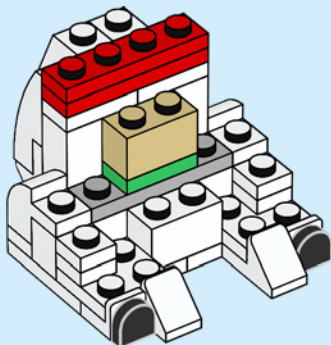

2x



2x

18

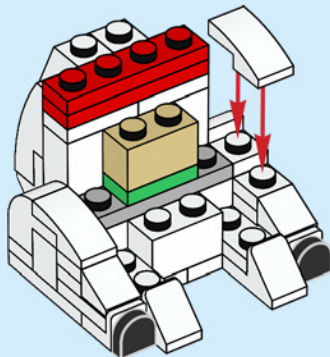

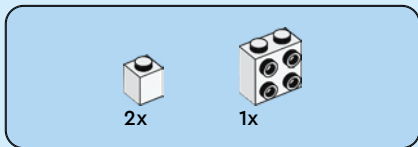

19

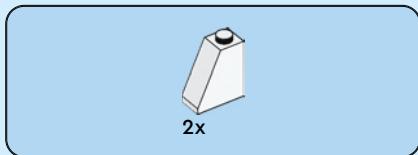
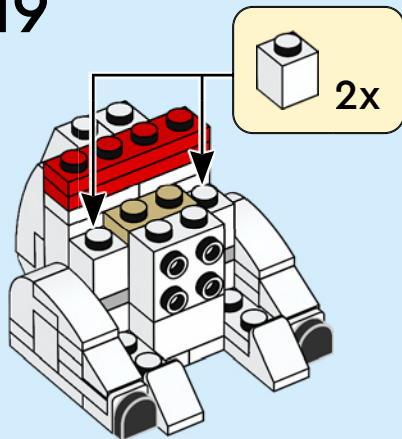

20

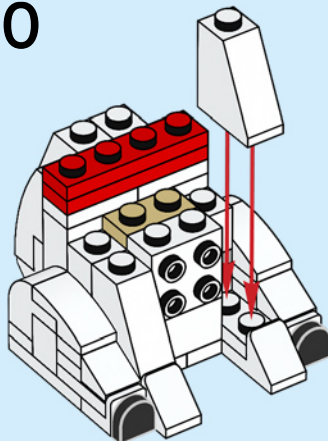



2x

# 21

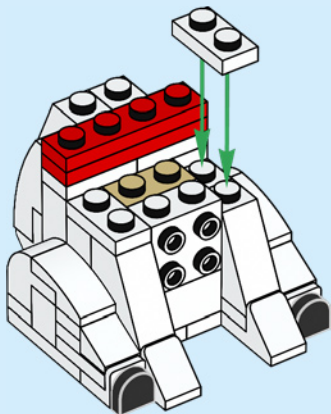

1x



1x

# 22

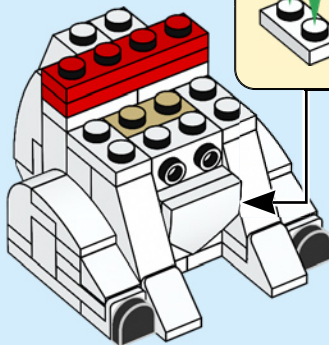



1x



1x



1x

# 23

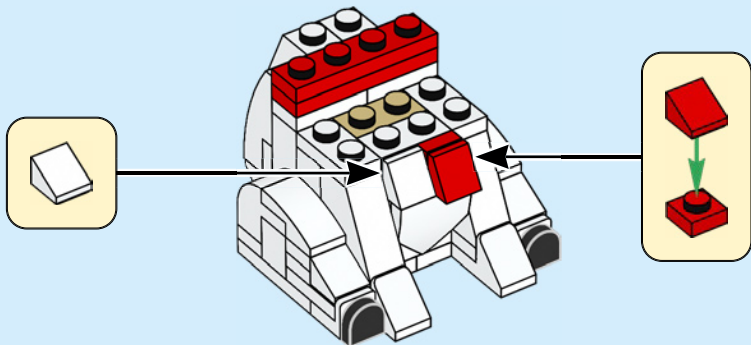



3x



2x

# 24

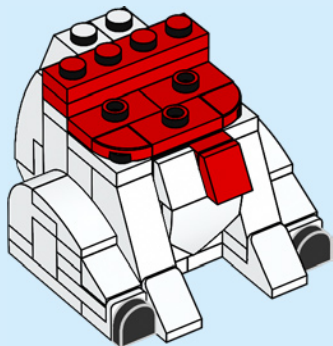

1x



1x

# 25

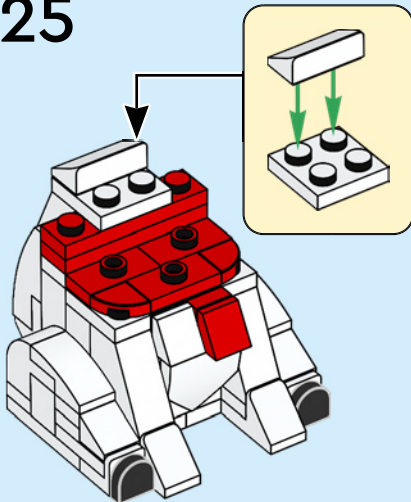



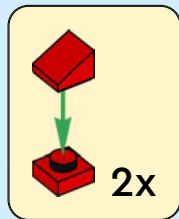
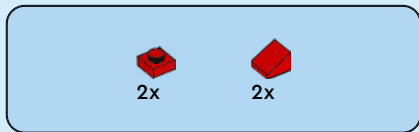

26

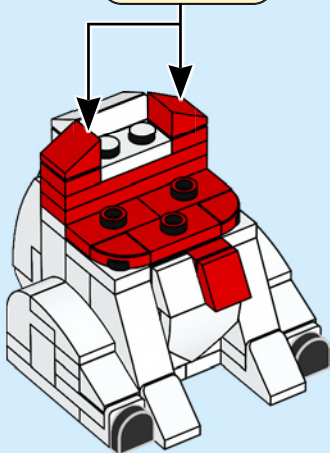



1x

27



1x

28

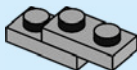



1x

29

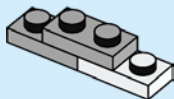

1x



1x

30

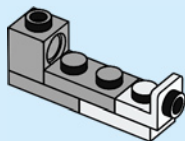



1x



1x

# 31

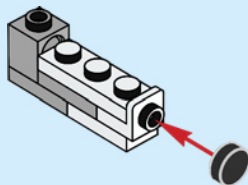

1x



1x

# 32

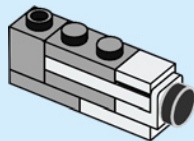



1x



1x

# 33

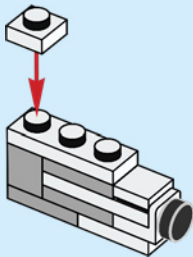

1x

# 34

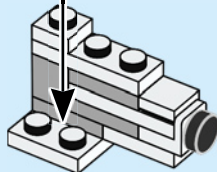
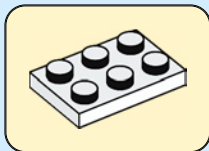



2x



2x

# 35

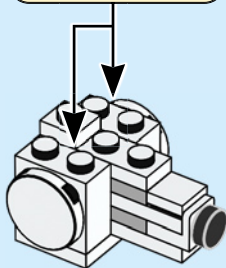
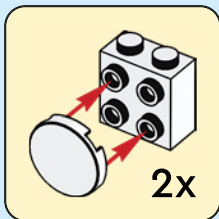

3x

# 36

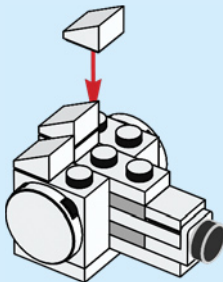

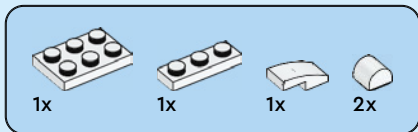

37

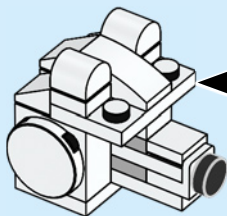
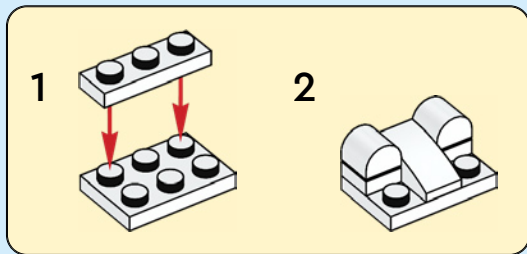



2x



2x



2x

# 38

1



2



1



2

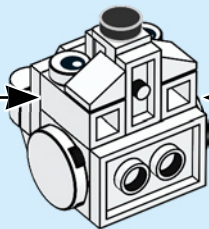





1x



2x

# 39

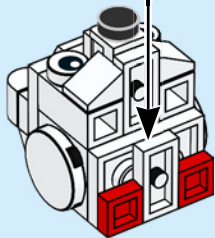
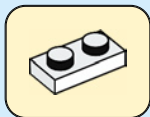

1x

# 40

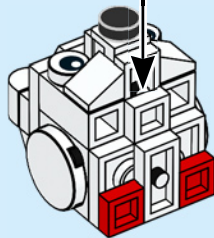



3x

41

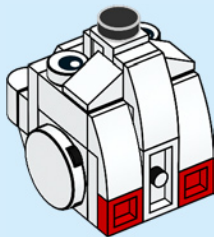

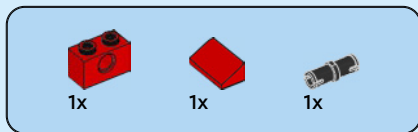

# 42

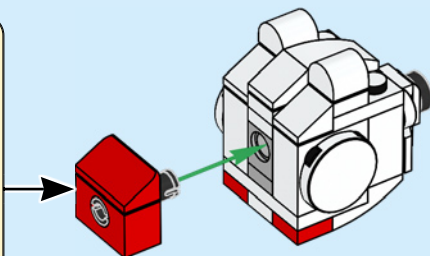
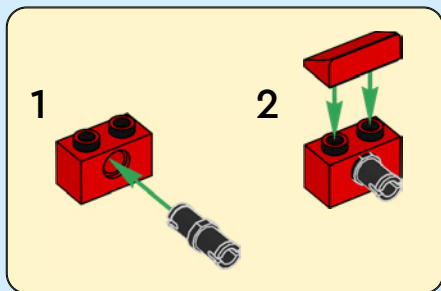

43

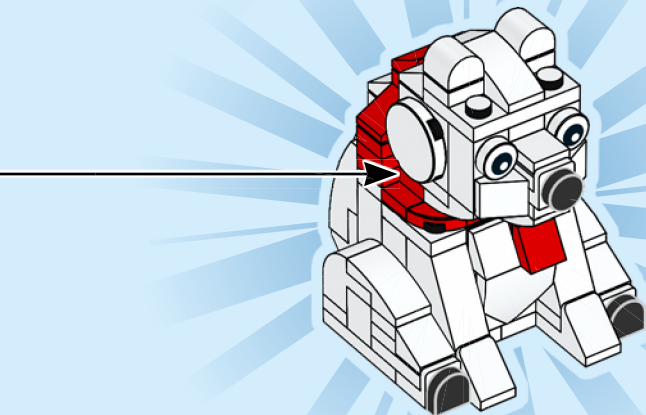

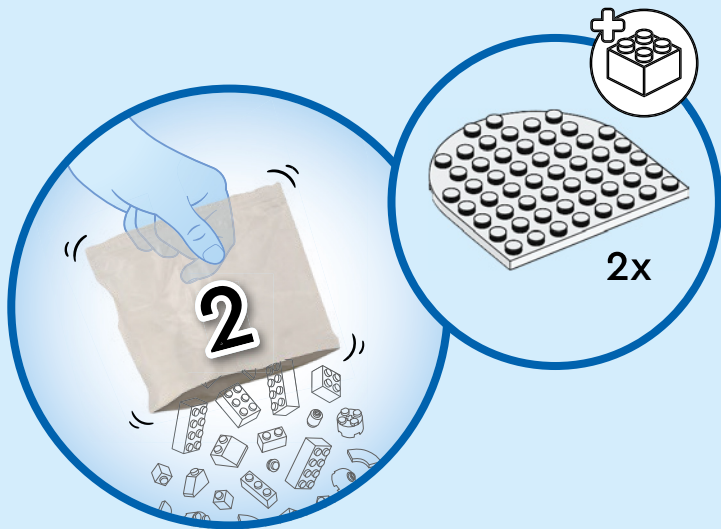

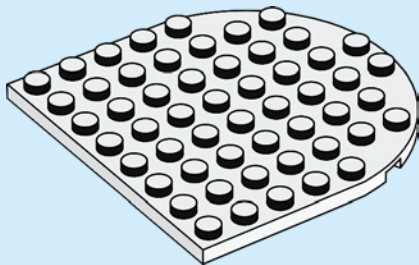
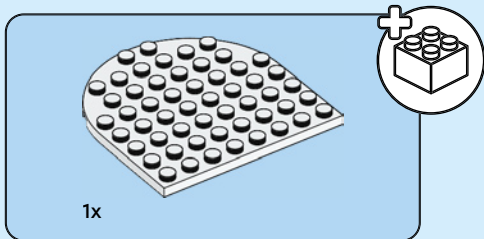
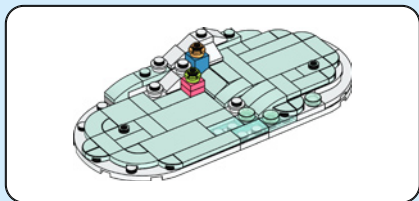

1



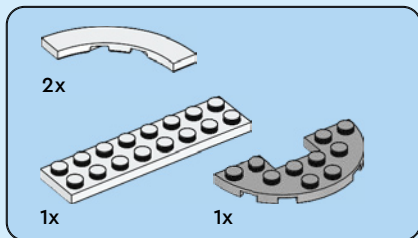

2

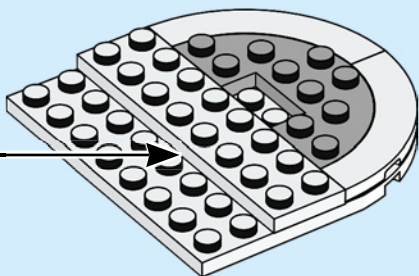
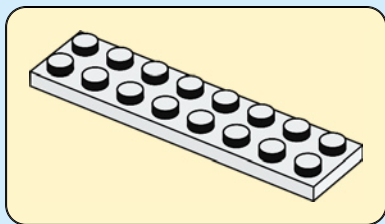



2x

3

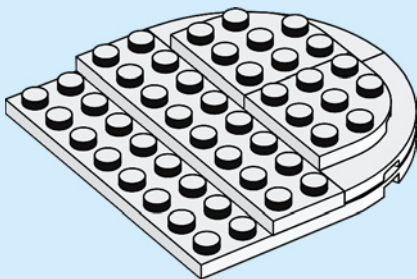





1x



1x



1x

4

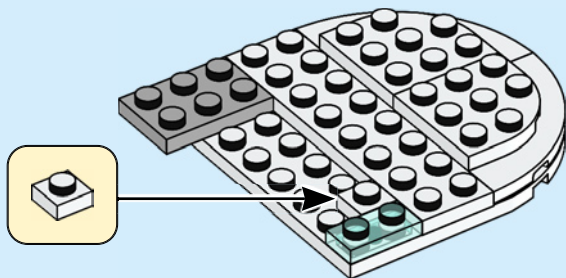

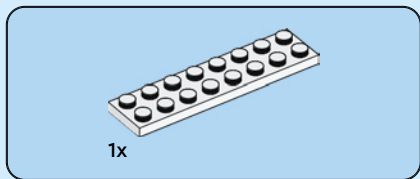

5

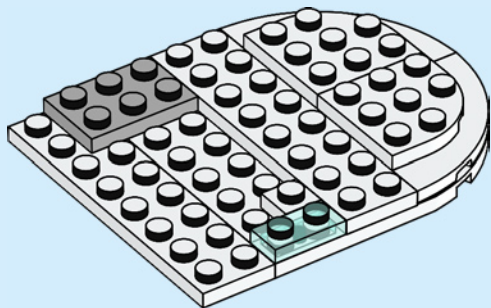

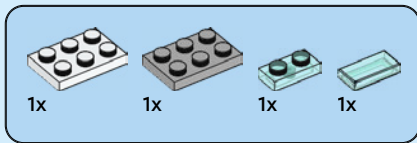

6

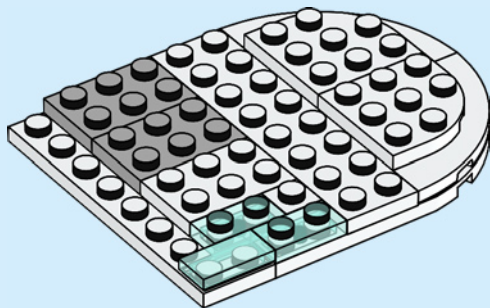

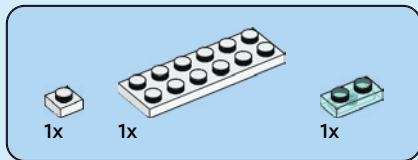

7

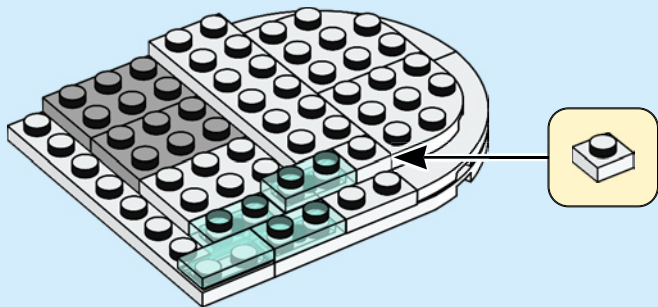

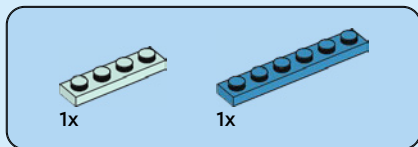

8

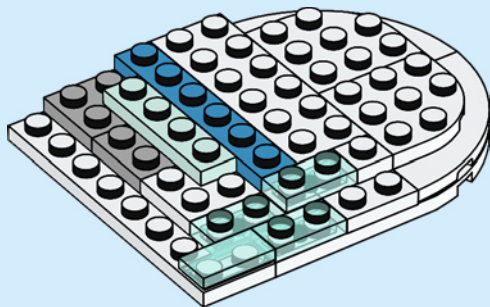

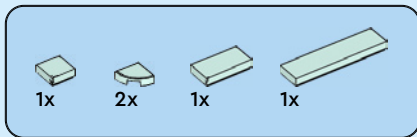

9

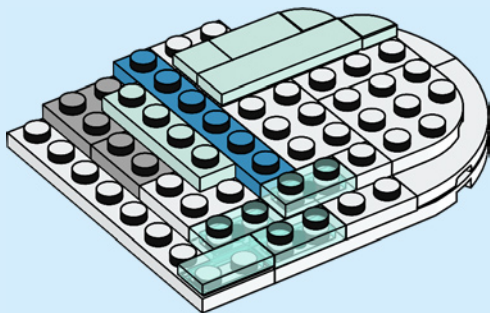

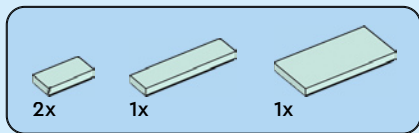

10

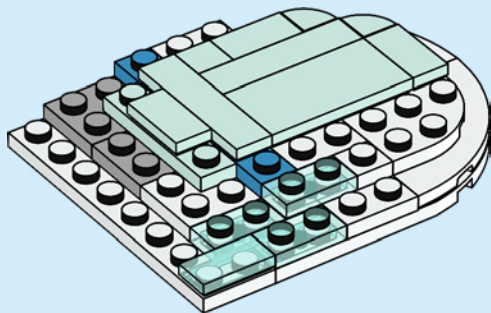

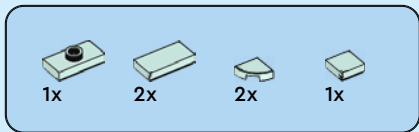

11

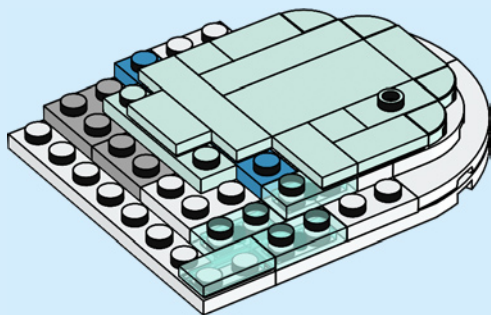





1x



3x

# 12

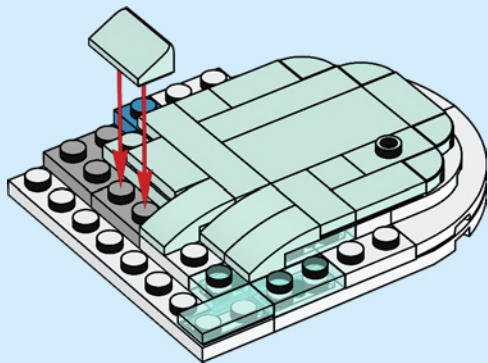



1x



2x



3x

# 13

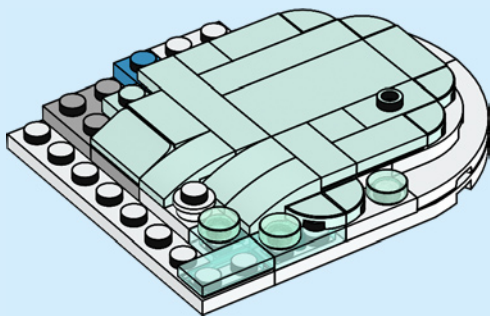



1x



1x

14

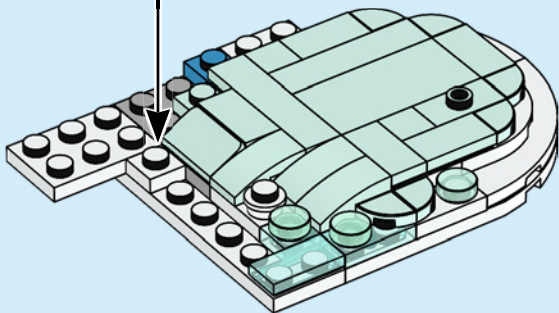



1x



1x

# 15

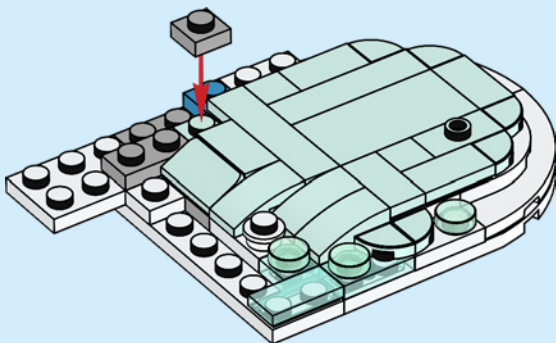

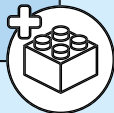
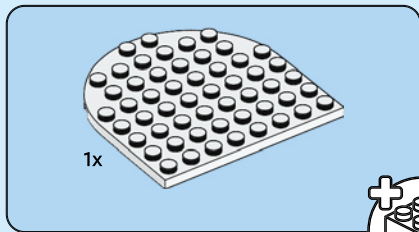

16

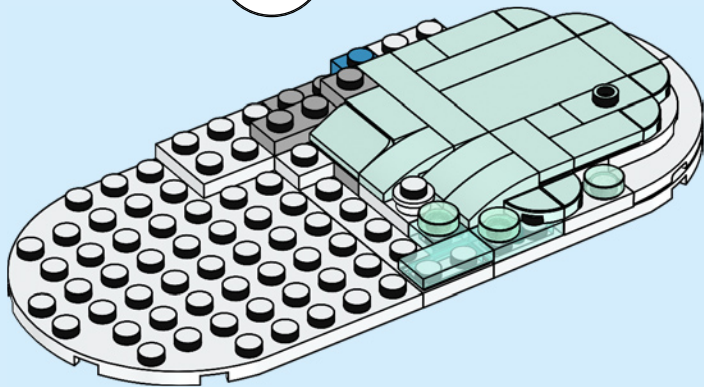

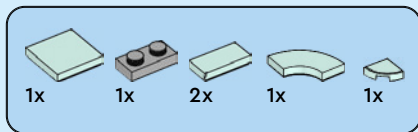

17

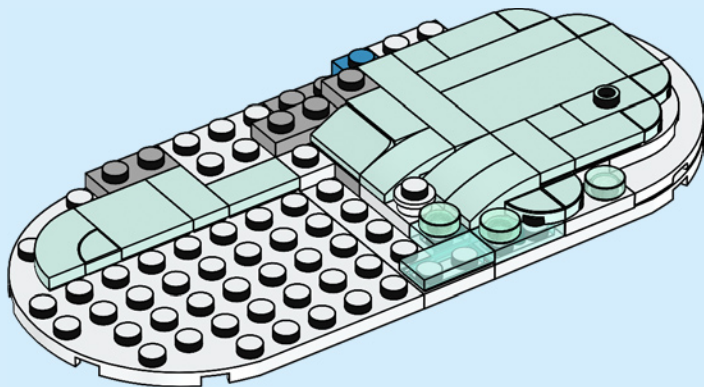

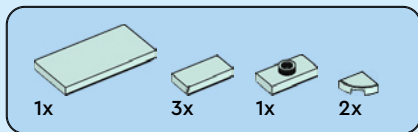

18

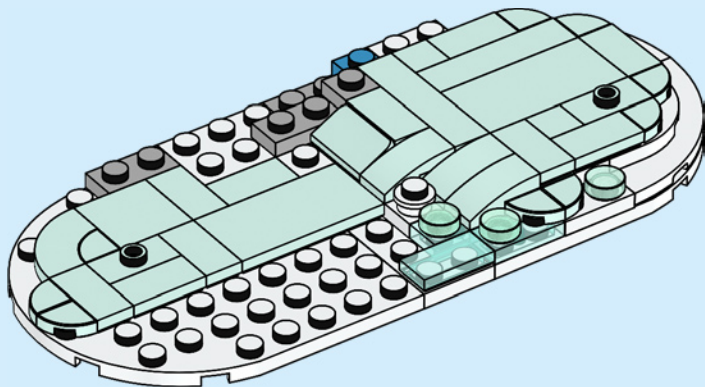

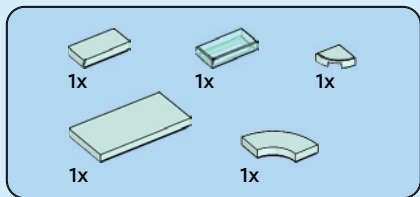

19

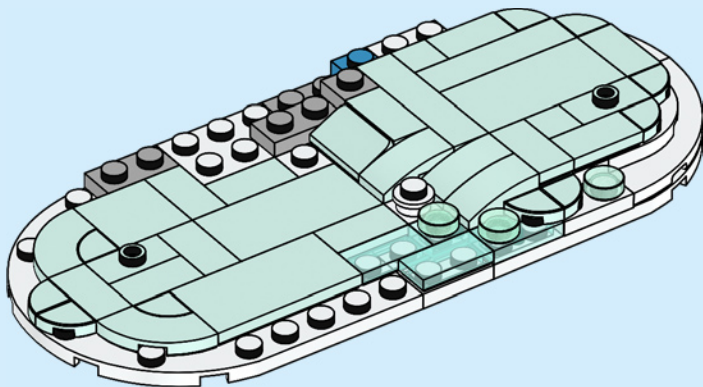



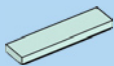

1x



1x

# 20

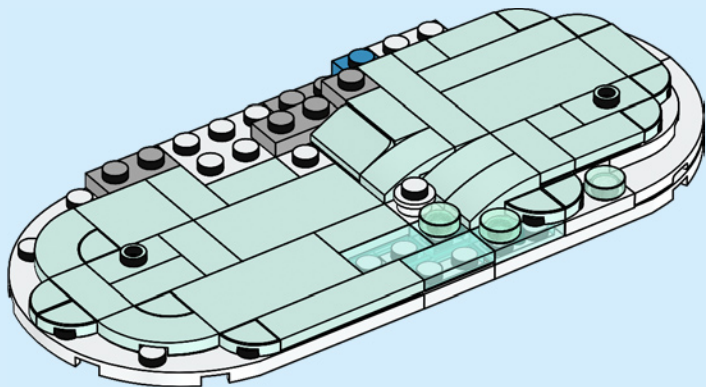

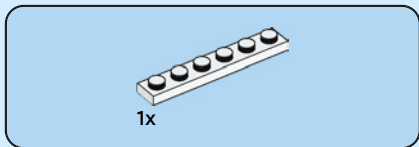

21

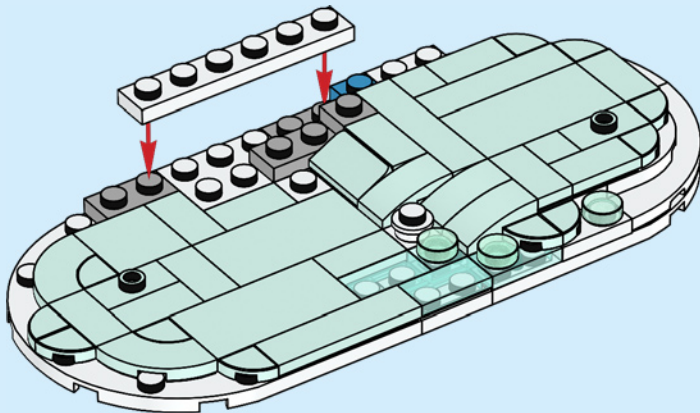

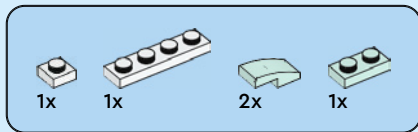

22

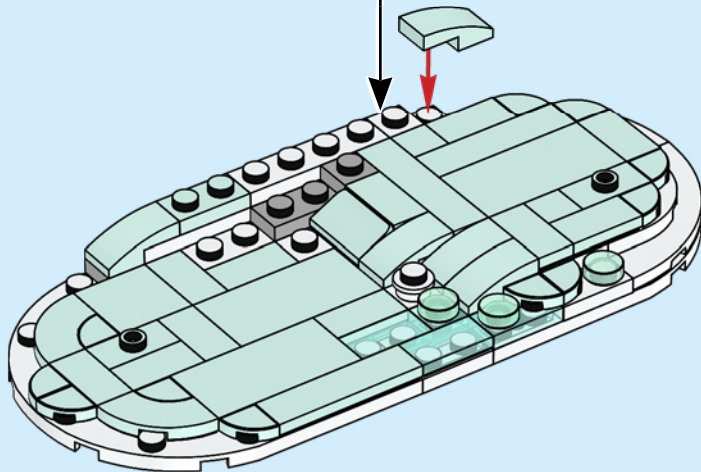



1x



1x



1x

# 23

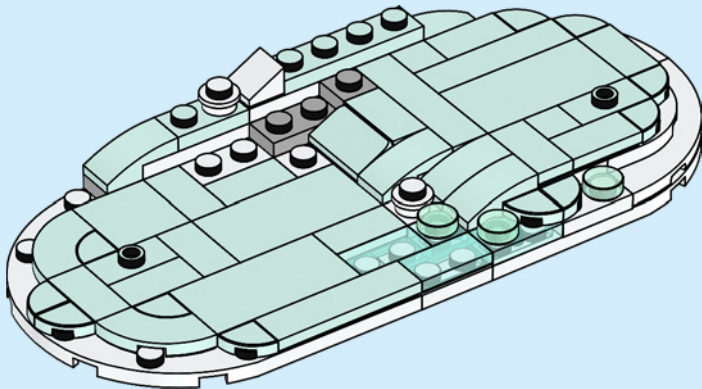



2x



2x

24

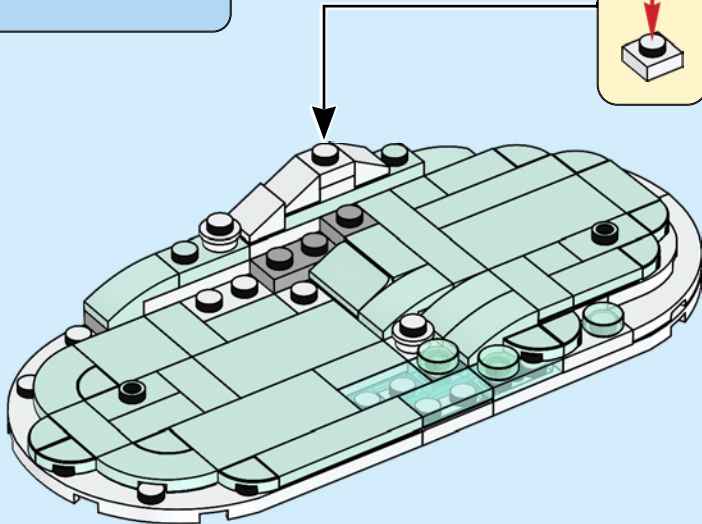
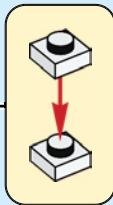



1x



1x



2x



1x

# 25

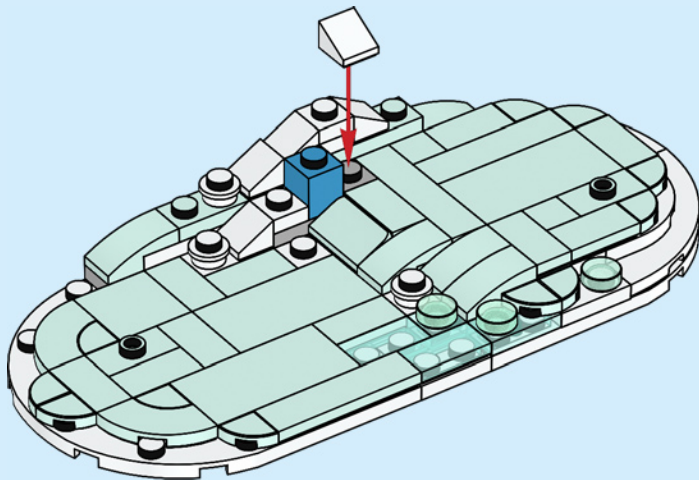



1x



1x

26

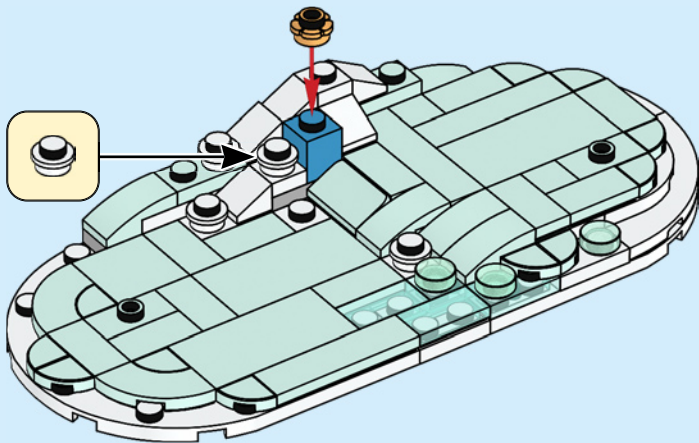



1x



2x

27

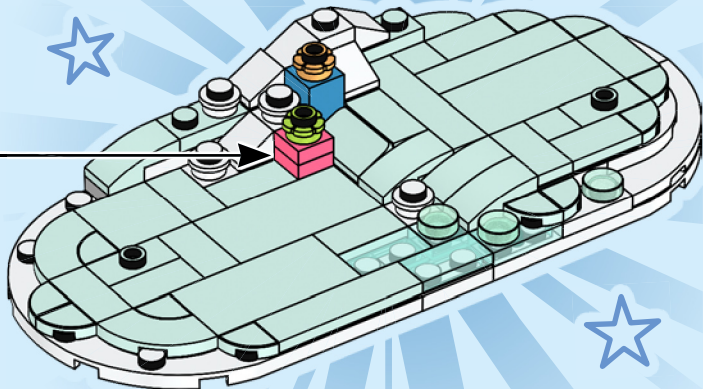
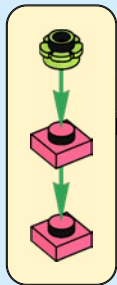





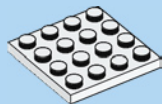
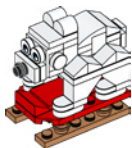

1x

1

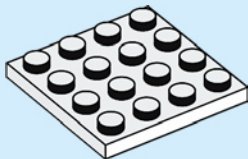

8x

2

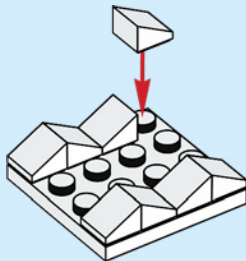

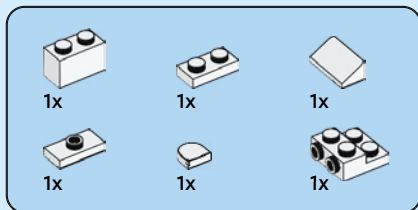

# 3

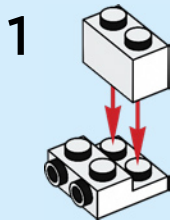

2

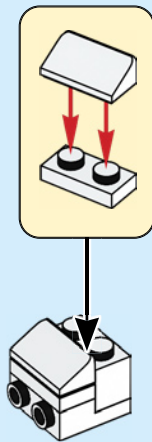

3

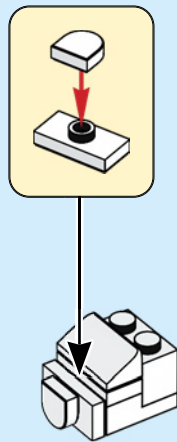

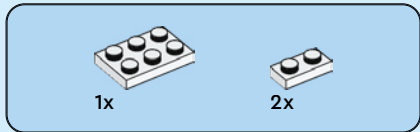
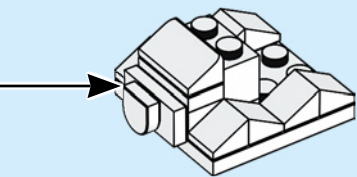

4

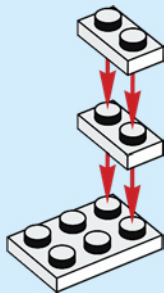



1x

5

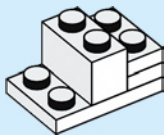

2x



2x

6

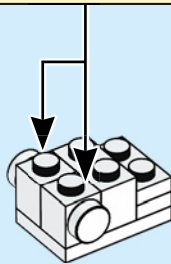
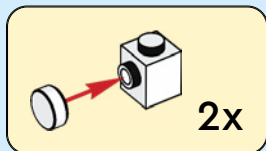



1x



1x

7

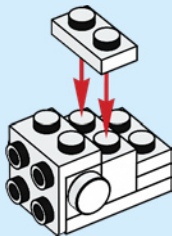

1x



2x

8

1



2

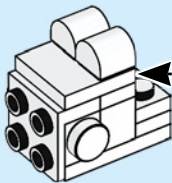
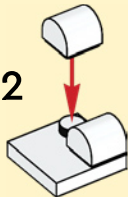



1x



1x



1x



2x

9

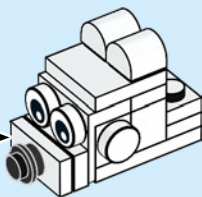
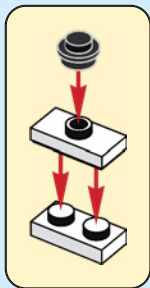

10

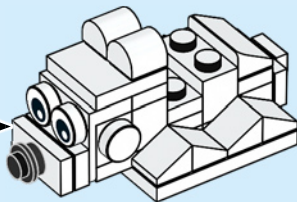



1x

11

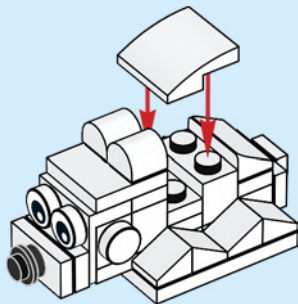





1x



2x

# 12



1



2

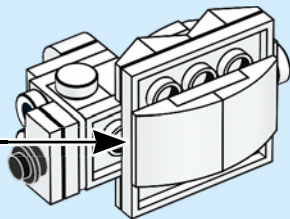
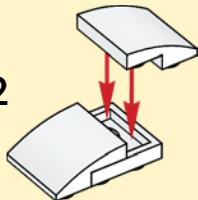



4x

13

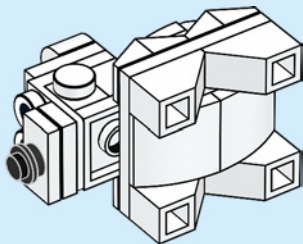

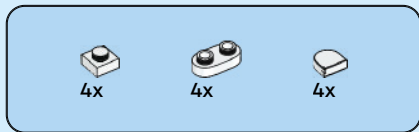

14

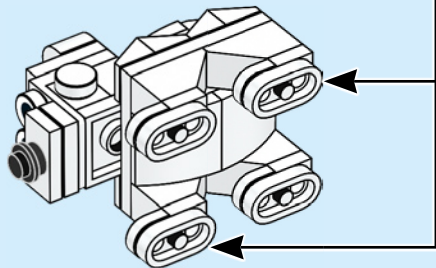
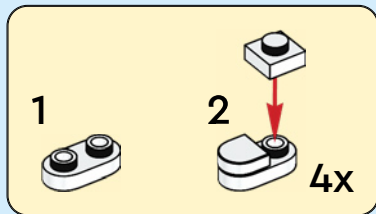



1x

15

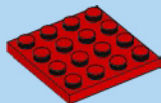
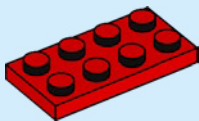

1x

16

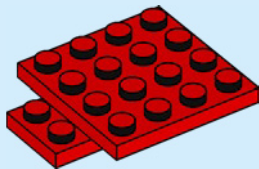



2x

17

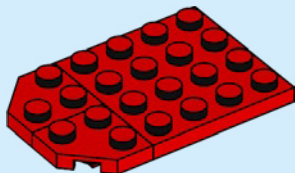

1x

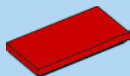

1x

18

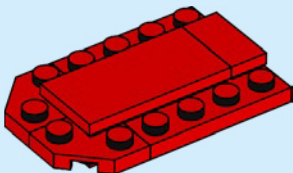

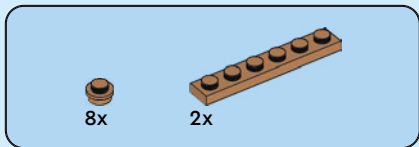

19

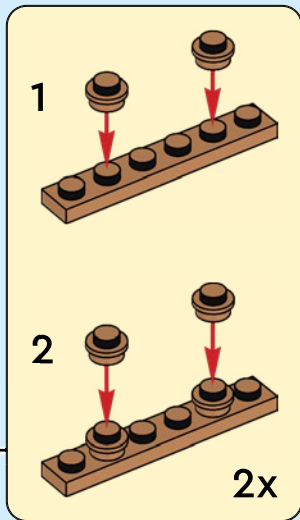
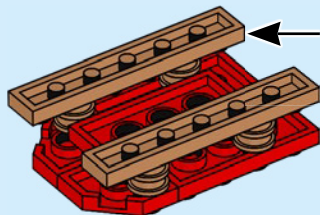
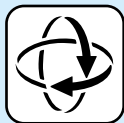

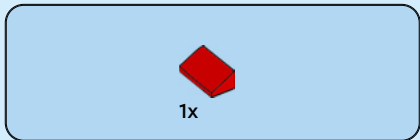

20

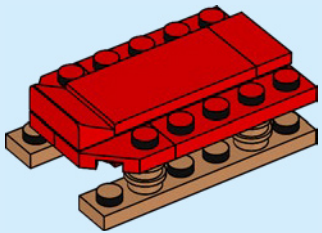

21

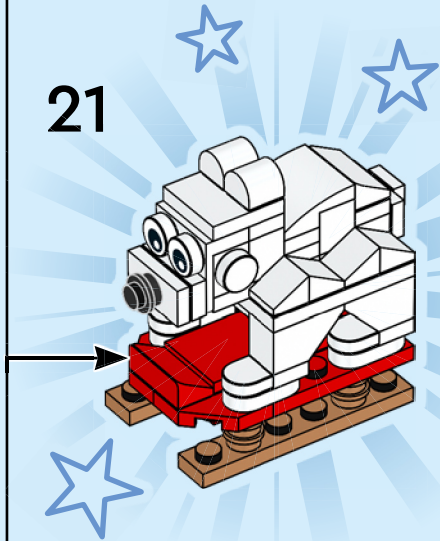



1







2x



2x



2x

# 2

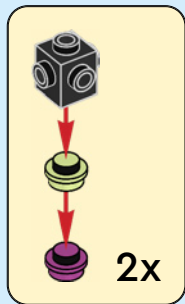

# 3



1x



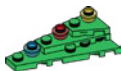

2x



1x



1x



1x



1x



1x

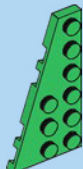

1x

4

1

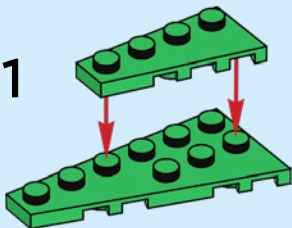

2

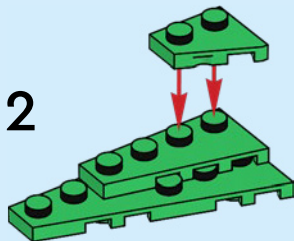

3

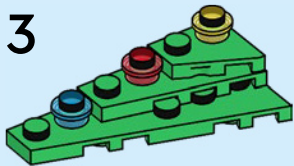

2x

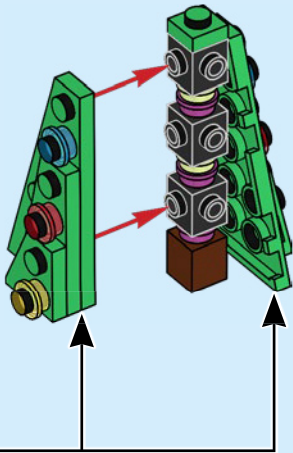

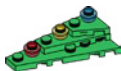

2x



1x



1x



1x



1x



1x

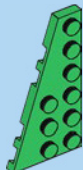

1x

5

1

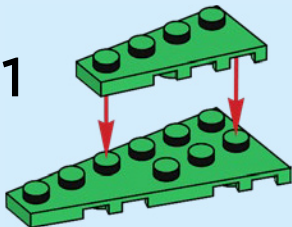

2

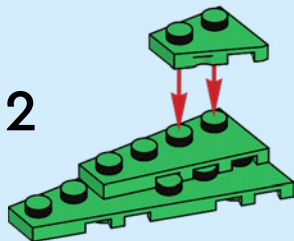

3

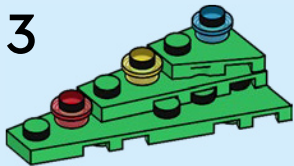

2x

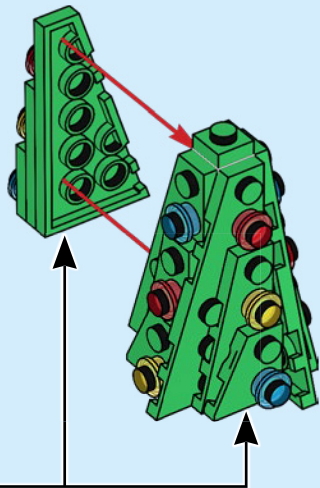



1x



3x



1x



1x

6

1



2

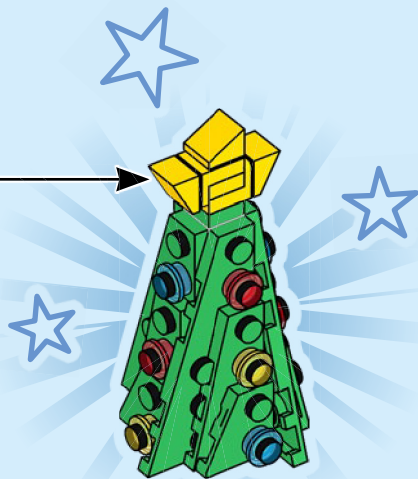
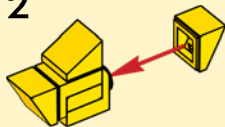

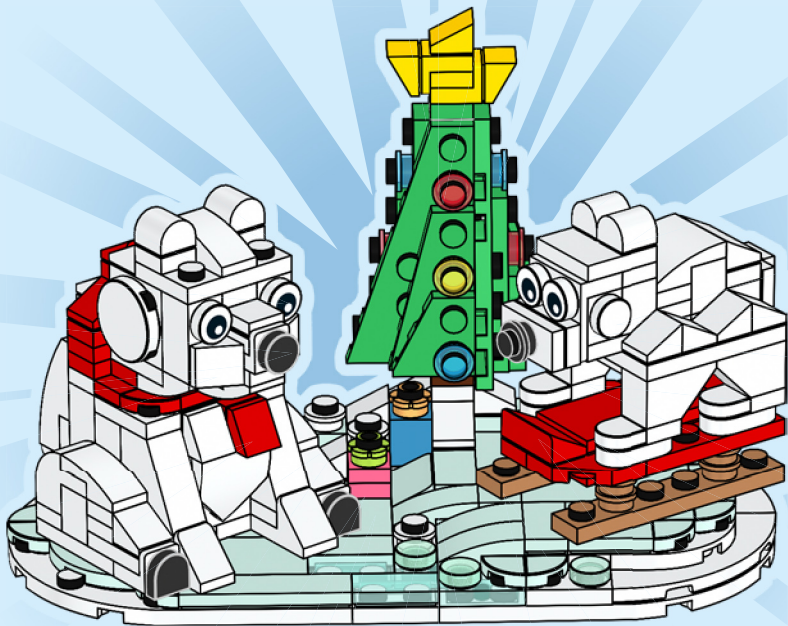



40570





  
2x  
6284572

  
4x  
6284599

  
4x  
614101

  
5x  
6250591

  
19x  
302401

  
1x  
307001

  
21x  
4504369

  
4x  
6258135

  
2x  
4558952

  
2x  
300501

  
4x  
6218841

  
3x  
6242241

  
4x  
6210272

  
2x  
4547489

  
2x  
6044691

  
4x  
6069002

  
4x  
366501

  
4x  
4515370

  
2x  
6051511

  
1x  
6301907

  
14x  
302301

  
2x  
6285777

  
3x  
300401

  
3x  
6172927

  
3x  
6034044

  
3x  
6218823

  
1x  
6117940

  
1x  
6218822

  
2x  
6210385

  
1x  
6047220

  
5x  
302201

  
1x  
6366391

  
1x  
6046979

  
2x  
4249112

  
3x  
362301

  
5x  
302101

  
1x  
371001

  
2x  
6104805

  
2x  
4550745



1x  
366601



1x  
300901



1x  
4243812



2x  
6195358



1x  
379501



2x  
303401

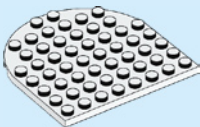

2x  
6249095



2x  
4579260



1x  
4114306



5x  
302421



3x  
4504379



2x  
6170390



2x  
4651524



1x  
370021



2x  
6173961



3x  
6092565



1x  
306921



2x  
371021



1x  
302021



1x  
4560179

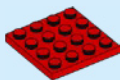

1x  
4243814



1x  
302424



3x  
4504381



1x  
6329867



1x  
6280475



1x  
6284070



1x  
614126



2x  
6256435



3x  
473326



1x  
6279875



1x  
302428



4x  
6385276



4x  
4543262



4x  
6328332



1x  
302128



4x  
6208450



3x  
6240222



2x  
6251295



4x  
6240214



4x  
6240216



1x  
6209692



3x  
6248970



1x  
4211242



1x  
4211399



1x  
4211535



5x  
4211398



1x  
4211388



2x  
4211396



1x  
4211445



1x  
6132983



1x  
6209691



8x  
6167641



2x  
6295464



1x  
6151657



1x  
6225538



2x  
6251846



11x  
6199886



2x  
6097303



5x  
6141593



11x  
6133247



1x  
6192270



1x  
4616211



2x  
6141592



3x  
6242256



2x  
6199894



1x  
6146701



2x  
6057898



2x  
6258091



3x  
6299900



3x  
6102537

Customer Service  
 Kundenservice  
 Service Client  
 Assistenza clienti  
 Atención al cliente  
 Serviço de Apoio ao Consumidor  
 Ügyfélszolgálat  
 Klientu apkalpošanas dienests  
 Serviciul pentru clienți  
 客户服务  
 コンシューマーサービス  
 고객 서비스

[LEGO.com/service](http://LEGO.com/service)

# WIN

Terms & Conditions apply

Scan this QR code or go to **LEGO.COM/PRODUCTFEEDBACK** and give us your short feedback about this LEGO® set for a chance to win a cool LEGO prize.



## GEWINNE

Scanne diesen QR-Code oder geh auf **LEGO.COM/PRODUCTFEEDBACK**

und gib uns dein kurzes Feedback zu diesem LEGO® Set. Dann hast du die Chance, einen coolen LEGO Preis zu gewinnen.

Es gelten die Teilnahmebedingungen

## GAGNE

Scannez ce code QR ou rendez-vous sur **LEGO.COM/PRODUCTFEEDBACK**

pour donner votre avis sur ce produit LEGO® et avoir une chance de gagner un prix LEGO.

Voir Conditions Générales

## GANA

Escanea este código QR o visita **LEGO.COM/PRODUCTFEEDBACK**

y comparte con nosotros tu opinión sobre este set LEGO® para tener la oportunidad de ganar un fantástico premio LEGO.

Términos y Condiciones aplicables

## 获取奖品

只需扫描此二维码或访问 **LEGO.COM/PRODUCTFEEDBACK**,

就这款乐高®套装提供简短反馈, 就有机会赢得很酷的乐高奖品。

《条款及条件》适用