







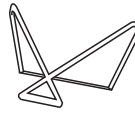

HANDLEIDING

A  1	B  1	C  1	D  1	E  M8 3	F  M8 3	G  M5 1
		H  M6 4	I  M6 4	J  M4 1	K  M6 4	

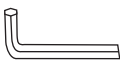
Stap 1: Verwijder het verpakkingsmateriaal. Zet onderdelen (C) en (D) op elkaar en zorg dat de schroefgaten overeen komen. Monteer met de schroeven (E) met daaronder de sluitringen (F). Draai aan met de inbusleutel (G).

Stap 2: Monteer aan de bovenzijde van de stoel kussen (A) met de schroeven (H). Draai aan met de inbusleutel (J). Monteer aan de onderkant kussen (B) met de schroeven (I) met daaronder de sluitringen (K). Draai stevig aan met de inbusleutel (J)

Stap 3: Zet de stoel in zijn normale positie en verzeker uzelf dat alles vast aangedraaid is. De montage is hiermee afgesloten.

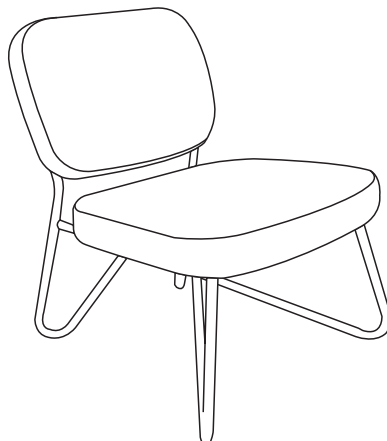
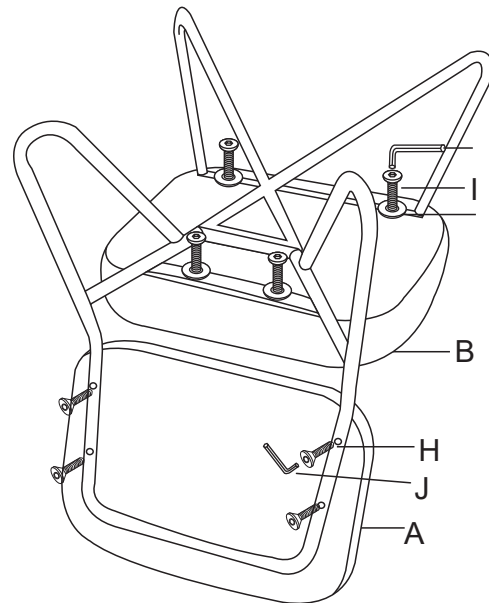
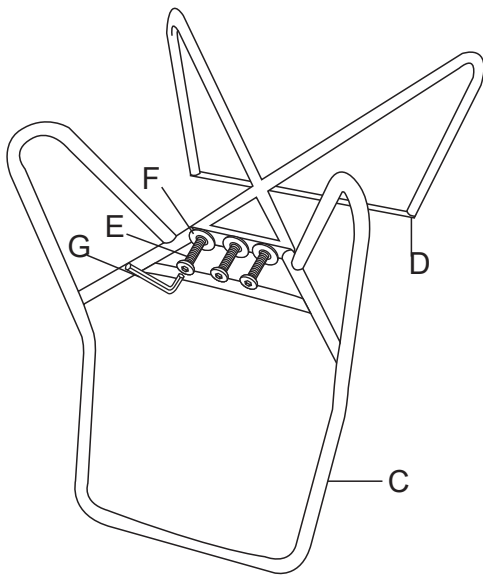

BRONX 71[®]