

9

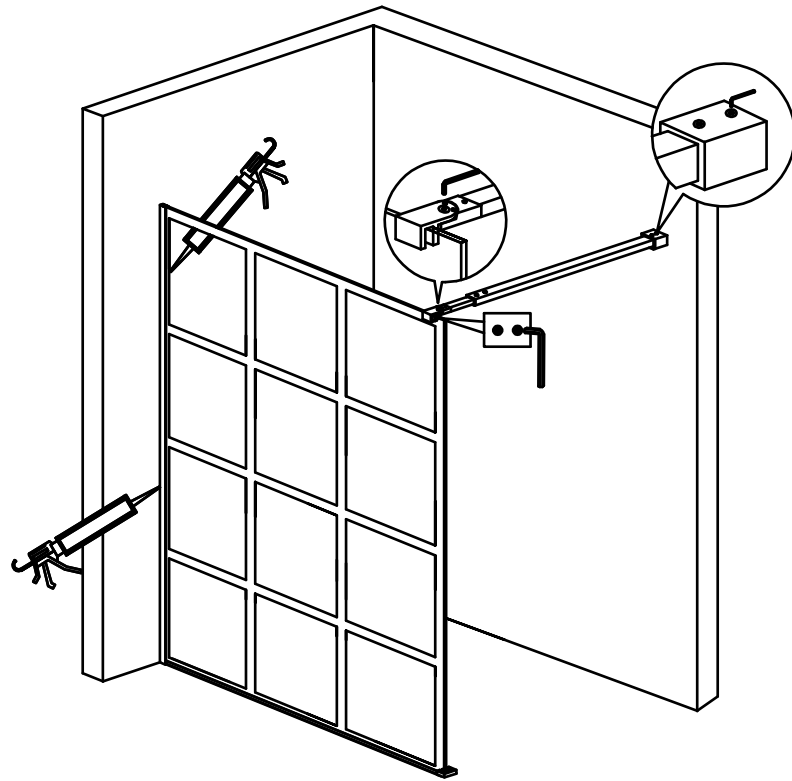

8

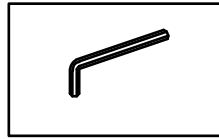
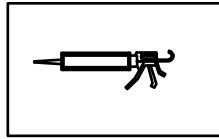
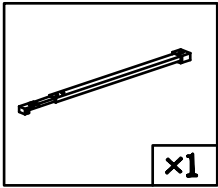
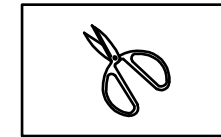
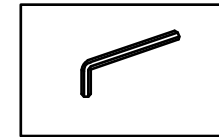
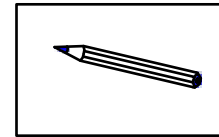
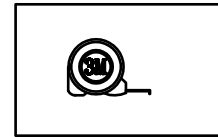
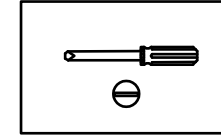
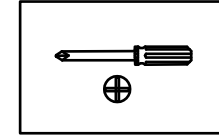
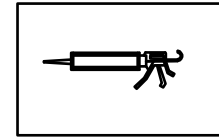
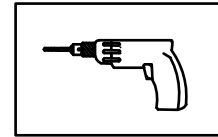
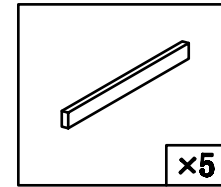
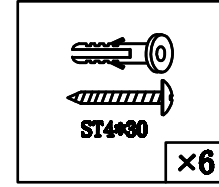
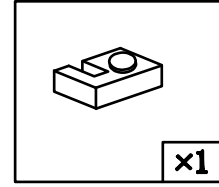
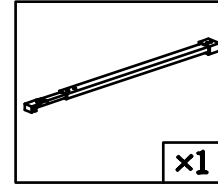
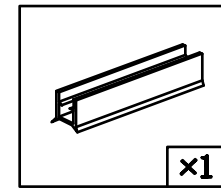
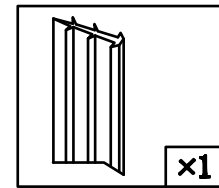
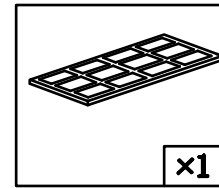
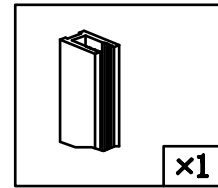

1

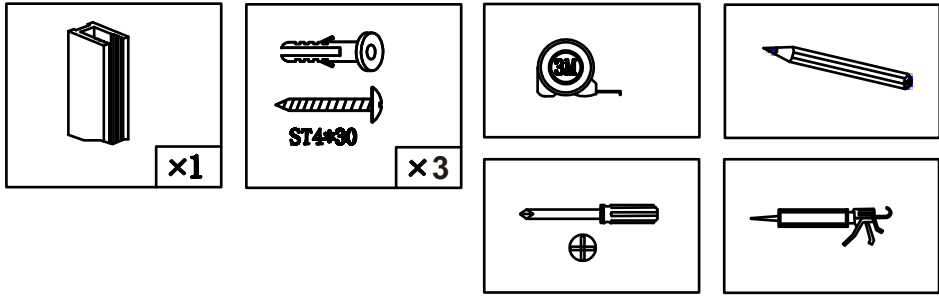

ATTENTION TO THE SIDE FOR SILICON

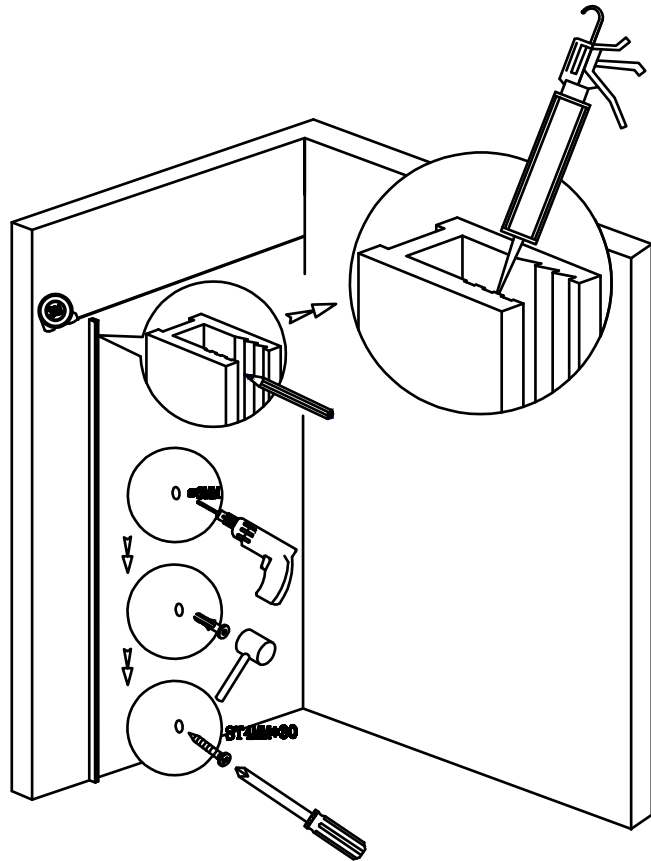

2

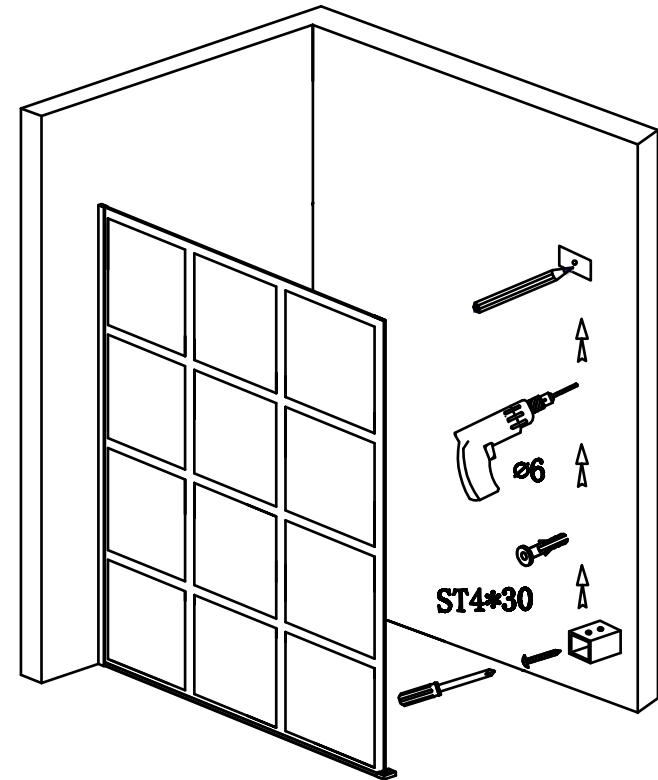
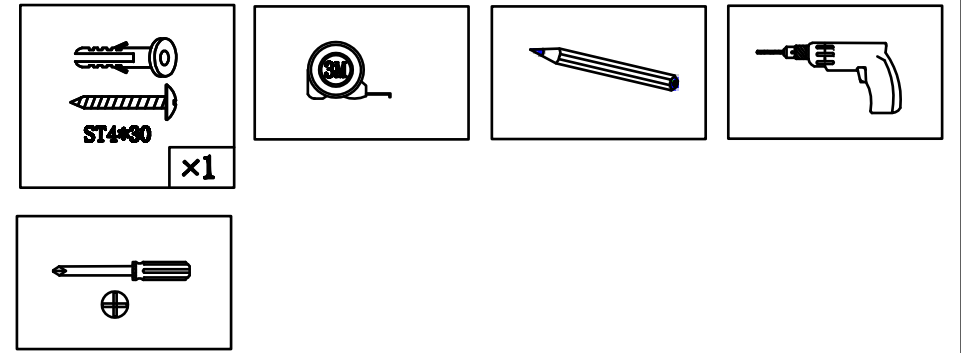

7

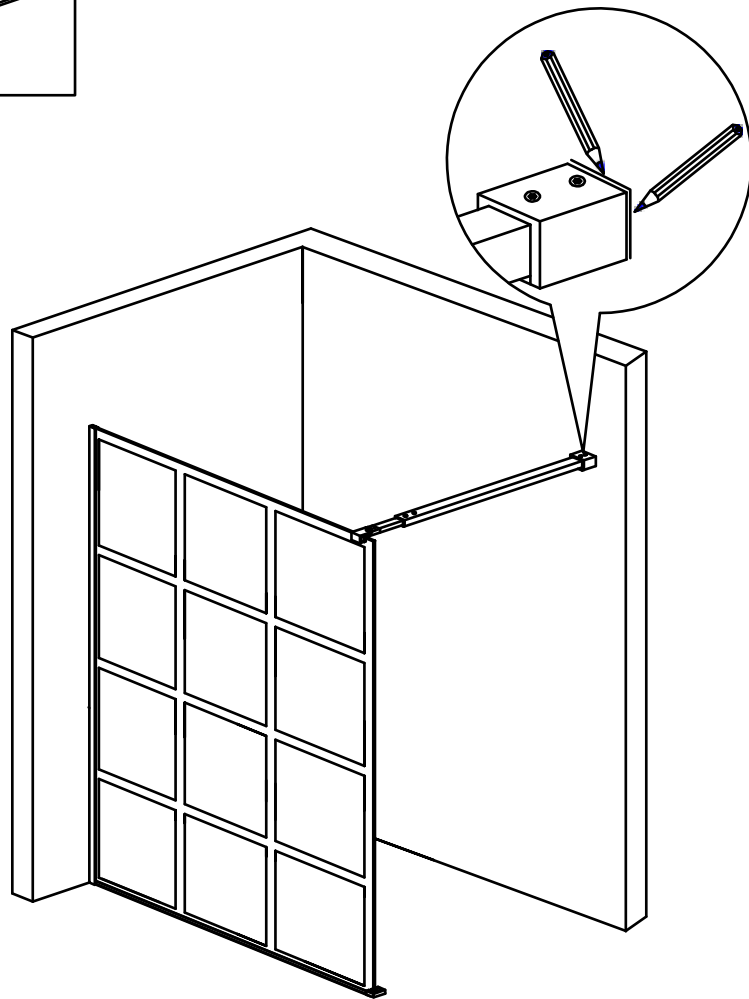
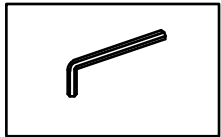
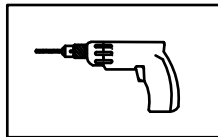
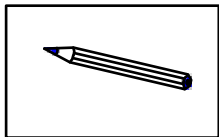
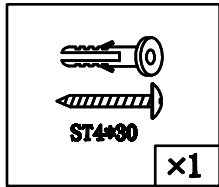
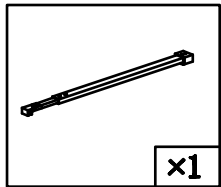

6

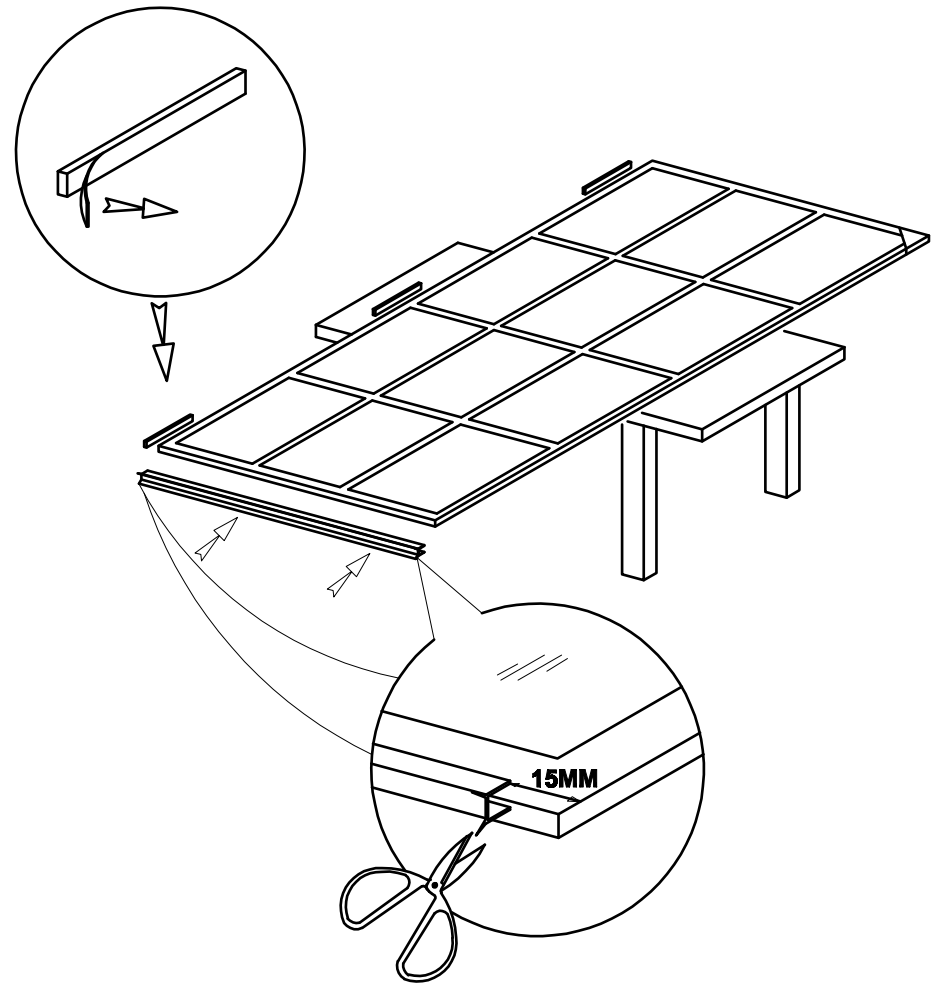
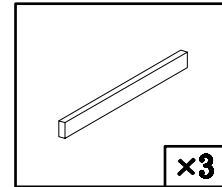
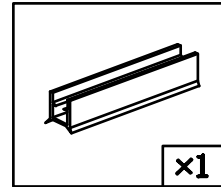
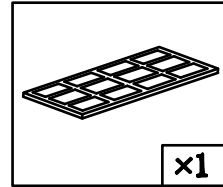

3

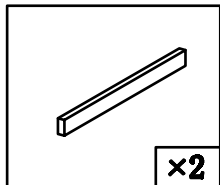
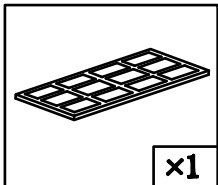

ATTENTION : MOVE SLOWLY !

