

WARRANTY

Thank you for purchasing the Qware streaming mic TRATTO 950. The product has warranty for two years. Our customer service will reply to you as soon as possible.

For questions and information: qware.nl

QWARE

STREAMING MIC

Model: QW GMI-950

Distributed by:

Pirox International B.V.

www.qware.nl

Blaak 6, 3011 TA Rotterdam

The Netherlands

Specifications are subject to change without prior notice. Made in China



model: QW GMI-950
CN GB/T14198-2012

Microphone Patent: ZL 2020 3 0246809.9
Microphone Stand Patent: ZL 2020 3 0246628.6
Microphone Shockproof Mount Patent: ZL 2020 3 0247301.0

TRATTO 950

PC - LAPTOP

USER MANUAL

HOW TO INSTALL YOUR MICROPHONE

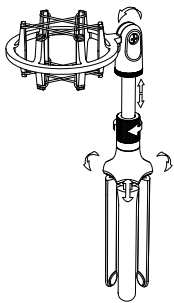

A

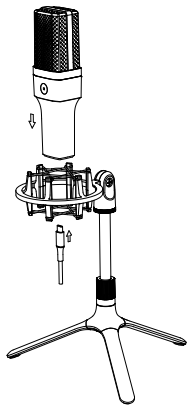

B

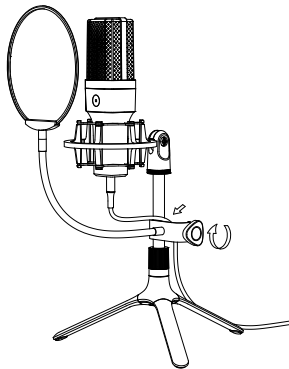

C

TRATTO 950

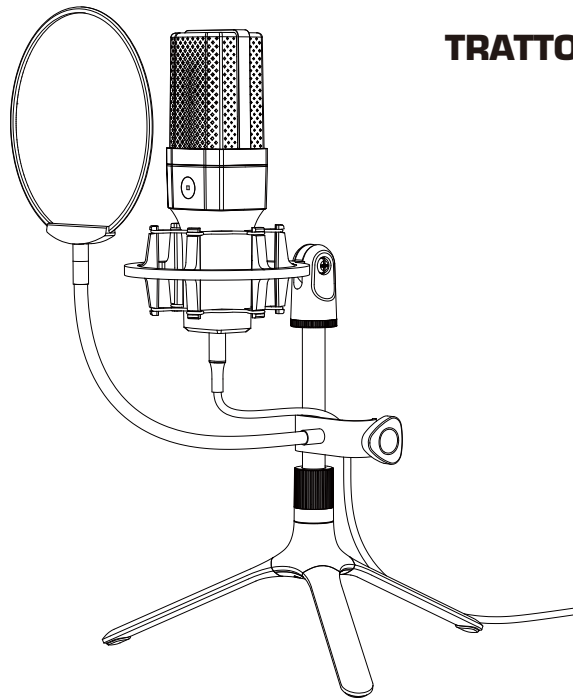

TRATTO 950



TRATTO 950

Package contents:

- Microphone
- Metal tri-pod stand
- 1.7-meter USB cable
- Pop filter
- High-end shock mount

Minimum requirements:

- PC or laptop with USB port
- Windows 7, 8, 10 or Mac OS x 10.5 (Leopard) or higher
- PS4™, PS5™

TRATTO 950



TRATTO 950

Technical specifications:

Microphone capsule:	Condenser / Capacitive
Frequency response:	20HZ-20kHz
Directivity:	Uni-directional (Cardioid)
The loudest level:	83dB
Signal to noise ratio:	82dB
Sensitivity:	-45dB \pm 3dB
Audio output line:	\varnothing 4.5mm x 1.7m
USB cable:	USB connection
Power supply:	USB DC 5V

TRATTO 950

FEATURES



7

TRATTO 950

MICROPHONE SET-UP



- 1 Plug the USB-C cable into the USB-C port of the microphone and connect the other end to the computer. After connecting the audio cable, you can start working directly.

POWER REQUIREMENTS

- 1 The microphone is powered by your device's USB port, meaning that in most situations you can just plug the microphone in and get started. For non standard USB ports, a powered USB hub may be required.
- 2 This is a "plug & play" USB device, compatible for both Windows and Mac computers. Placement of the microphone can cause different recording results.

8

TRATTO 950

- 3 An ideal starting point for the reference is to place the MIC directly in front of the user at 15 cm (6") distance. Moving the MIC a little closer will make the vocal sound more intimate and full, while moving the MIC back will give the vocal sound a little more 'air' or room-sound and will reduce the proximity effect (increased bass or low frequency response when the sound source is very close).
- 4 Experimenting can be done with the angle, how the microphone is placed, as different results can be achieved when the user is 'off-axis' to the microphone.

TRATTO 950

GENERAL OPERATION MAC OS

To manually adjust your input level via your computer's system preferences, use the following instructions relevant to your device platform/operating system. Adjusting the input level on a Mac OS computer:

- 1 Click on the Apple symbol at the top left of your screen, and select System Preferences.



- 2 Click on 'Sound' to open the sound options

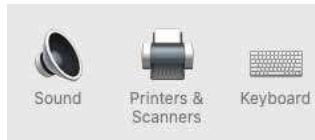

TRATTO 950

- 3 Open the 'Input tab'.
- 4 From here, select the 'USB Audio Device' from the list devices, and adjust the input level using the slider.

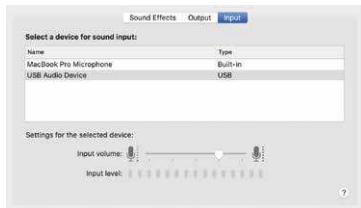

GENERAL OPERATION WINDOWS

Adjusting the input level on a Windows computer:

- 1 Open the Start menu and click on 'Control panel'

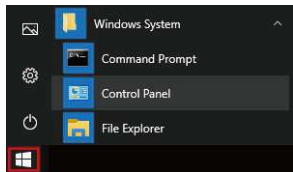

TRATTO 950

- 2 Open the 'Sound' preferences from within the 'Control panel' folder

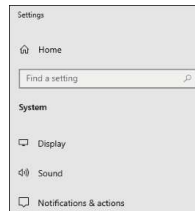

- 3 Choose the MIC in the input display

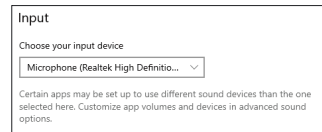

TRATTO 950

- 4 Adjust the input level using the slider.

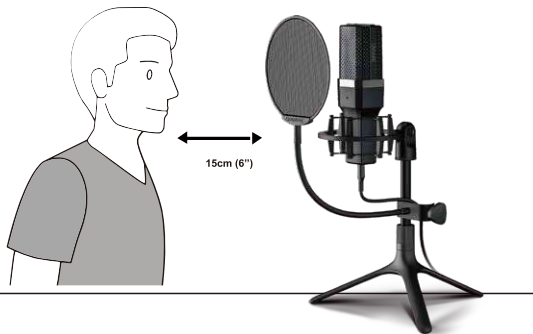
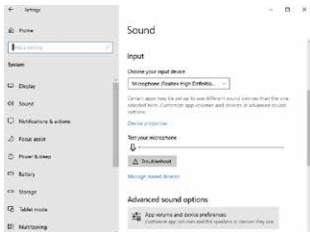

TRATTO 950

NOTE

- 1 Do not cover the microphone grille with your hand.
- 2 Regular maintenance is recommended to avoid short circuit.

QWARE

STREAMING MIC

TRATTO 950

PC - LAPTOP

ISTRUZIONI  NDLEIDING

HOW TO INSTALL YOUR MICROPHONE

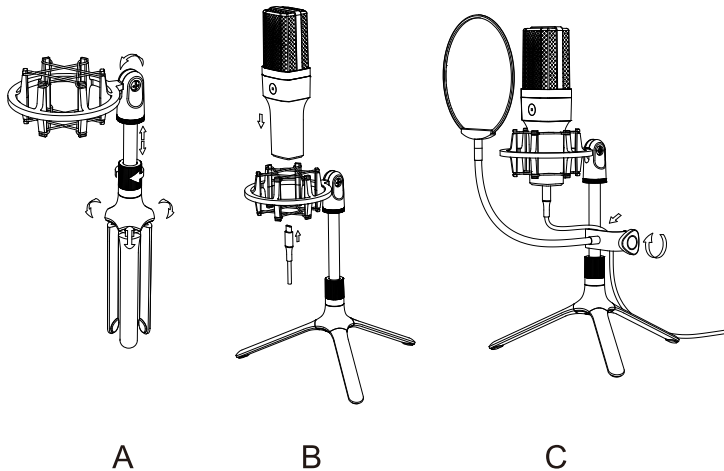

TRATTO 950

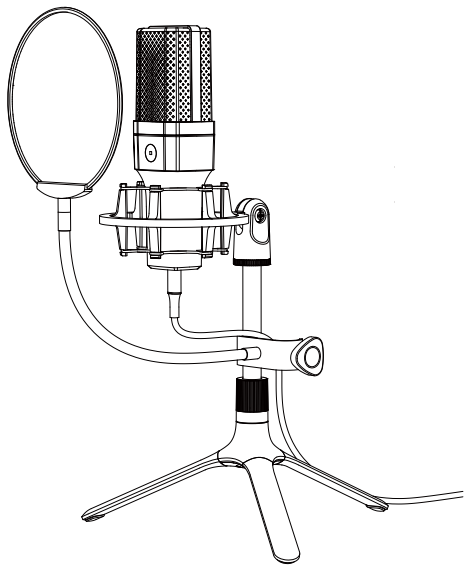

TRATTO 950



TRATTO 950

Inhoud van de verpakking:

- Microfoon
- Metalen tri-pod-standaard
- 1,7-meter USB-kabel
- Pop-filter
- Hoogwaardige schokbevestiging

Minimale vereisten:

- PC of laptop met USB-poort
- Windows 7, 8, 10 of Mac OS x 10.5 (Leopard) of hoger
- PS4™, PS5™

TRATTO 950



TRATTO 950

Technische specificaties:

Microfooncapsule:	Condensator / Capacitief
Frequentierespons:	20HZ-20kHz
Richting:	Uni-directioneel (cardioïde)
Luidste niveau:	83dB
Signaal-ruisratio:	82dB
Gevoeligheid:	-45dB ± 3dB
Audio-uitgangskabel:	Ø4,5mm x 1,7m
USB-kabel:	USB-verbinding
Voeding:	USB DC 5V

TRATTO 950

FUNCTIES

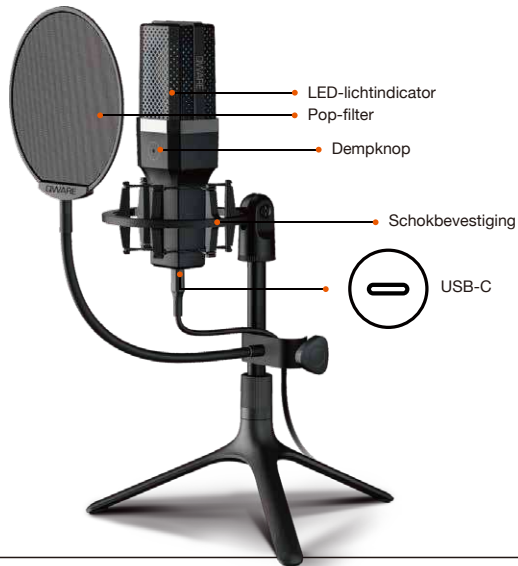

TRATTO 950

MICROFOONINSTELLING



- 1 Sluit de USB-C-kabel aan op de USB-C-poort van de microfoon en sluit het andere uiteinde aan op de computer. Na het aansluiten van de audiokabel kunt u direct beginnen.

VOEDINGSVEREISTEN

- 1 De microfoon wordt gevoed door de USB-poort van uw apparaat, wat betekent dat u meestal de microfoon alleen maar hoeft aan te sluiten.

Voor non-standaard USB-poorten, kan een gevoede USB-hub vereiste zijn.
- 2 Dit is een "plug & play" USB-apparaat, compatibel voor zowel Windows- als Mac-computers. Plaatsing van de microfoon kan verschillende opnameresultaten veroorzaken.

TRATTO 950

- 3 Een ideaal startpunt de referentie is om de MIC direct voor de gebruiker, op een afstand van 15 cm (6") te plaatsen. Als de MIC iets dichterbij wordt geplaatst, wordt het stemgeluid intiemer en voller. Als de MIC verder weg wordt geplaatst, krijgt het stemgeluid meer 'lucht' of wordt het ruimtelijker en wordt het nabijheidseffect gereduceerd (verhoogde bass of lagere frequentierespons als geluidsbron dichtbij is).
- 4 Er kan met de hoek worden geëxperimenteerd, hoe de microfoon wordt geplaatst, omdat er verschillende resultaten kunnen worden bereikt als de gebruiker een andere hoek tot de microfoon heeft.

TRATTO 950

ALGEMENE INSTELLING MAC OS

Om het ingangsniveau via de systeemvoorkeuren van uw computer aan te passen, gebruik de volgende instructies voor uw platform/besturingssysteem. Het ingangsniveau op een computer met MAC OS aanpassen:

- 1 Klik op het Apple-symbool linksboven in uw scherm en selecteer Systeemvoorkeuren.

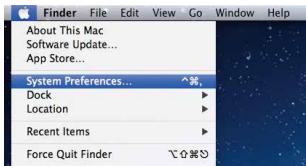

- 2 Klik op 'Geluid' om de geluidsopties te openen

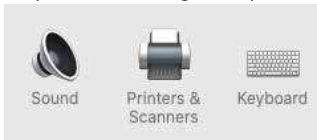

TRATTO 950

- 3 Open het tabblad 'Ingang'.
- 4 Van hieruit, selecteer 'USB audio-apparaat' uit de lijst met apparaten en pas het ingangsniveau met de schuif aan.

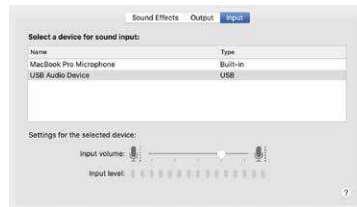

ALGEMENE INSTELLING WINDOWS

Het ingangsniveau op een computer met Windows aanpassen:

- 1 Open het menu Start en klik op 'Configuratiescherm'

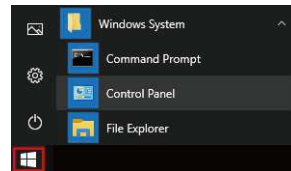

TRATTO 950

- 2 Open 'Geluid' binnen de map 'Configuratiescherm'

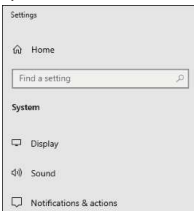

- 3 Selecteer de MIC in het scherm

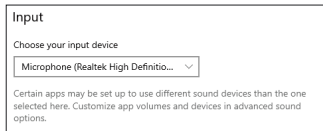

TRATTO 950

- 4 Pas het ingangsniveau met de schuif aan.

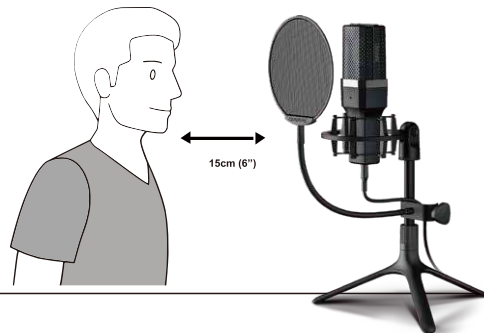
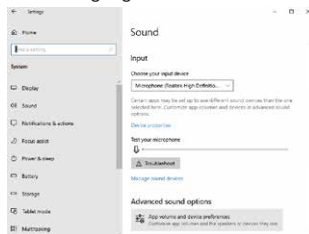

TRATTO 950

OPMERKING

- 1 Dek de microfoon-grill niet af met uw hand.
- 2 Regelmatig onderhoud is raadzaam om kortsluiting te voorkomen.

QWARE

STREAMING MIC

TRATTO 950

PC - LAPTOP

BEDIENUNGSANLEITUNG

HOW TO INSTALL YOUR MICROPHONE

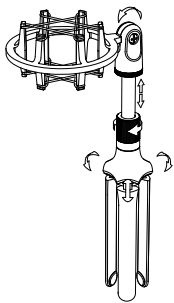

A

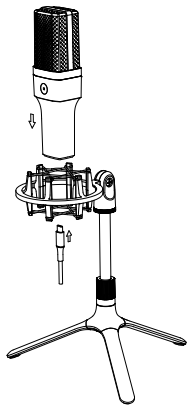

B

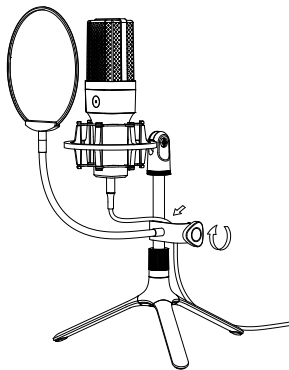

C

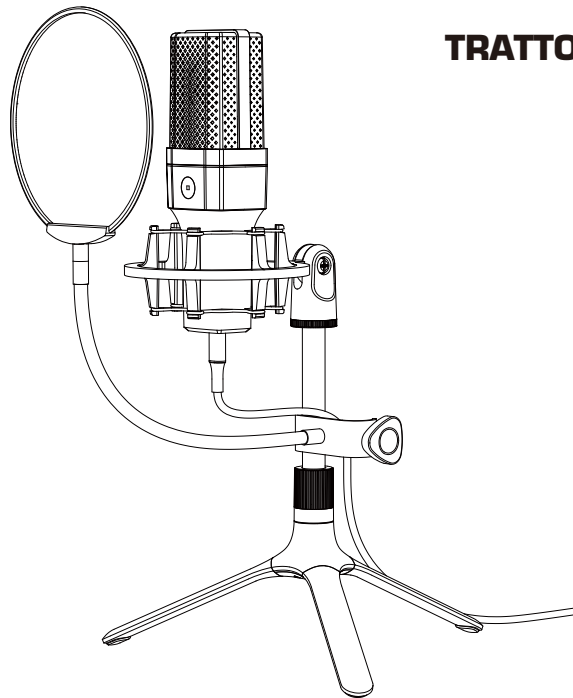

TRATTO 950

TRATTO 950



TRATTO 950

Lieferumfang:

- Mikrofon
- Metallstativ
- USB-Kabel mit 1,7 m Länge
- Pop-Filter
- Hochwertige Stoßdämpfer

Mindestanforderungen:

- PC oder Laptop mit USB-Anschluss
- Windows 7, 8, 10 oder Mac OS x ab 10.5 (Leopard)
- PS4™, PS5™

TRATTO 950



5

TRATTO 950

Technische Daten:

Mikrofonkapsel:	Kondensator/kapazitiv
Frequenzgang:	20 Hz - 20 kHz
Richtcharakteristik:	Gerichtet (Kardioide)
Lauteste Einstellung:	83 dB
Signal-Rausch-Verhältnis:	82 dB
Empfindlichkeit:	-45 dB \pm 3 dB
Tonausgangskabel:	\varnothing 4,5 mm x 1,7 m
USB-Kabel:	USB-Anschluss
Spannungsversorgung:	USB DC 5 V

6

TRATTO 950

MERKMALE

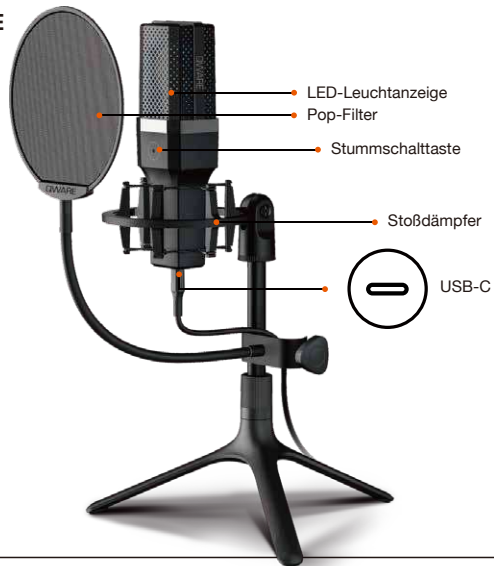

7

TRATTO 950

MIKROFONAUFBAU



- 1 Stecken Sie ein Ende des USB-C-Kabels in den USB-C-Anschluss des Mikrofons und das andere in den Computer. Nach Anschluss des Tonkabels können Sie sofort mit dem Betrieb beginnen.

SPANNUNGSANSCHLUSS

- 1 Das Mikrofon erhält seine Spannung über den USB-Anschluss, d. h. in den meisten Fällen können Sie es einfach an Ihrem Gerät einstecken und mit der Aufnahme beginnen.
Bei nicht standardisierten USB-Anschlüssen kann ein gespeister USB-Hub
- 2 Es handelt sich um ein „Plug & Play“-USB-Gerät für Windows- und Mac-Computer. Die Positionierung des Mikrofons kann bei der Aufzeichnung unterschiedliche Ergebnisse hervorrufen.

8

TRATTO 950

- Es ist ein idealer Bezugspunkt, wenn das Mikrofon in einem Abstand von 15 cm vor dem Sprecher steht. Wenn Sie es etwas näher aufstellen, wirkt die Tonaufnahme intimer und voller, während eine Verlagerung nach hinten ihr etwas mehr „Luft“ oder Raumklang verleiht und den Nahbesprechungseffekt (bei sehr naher Schallquelle erhöhte Bässe oder niedriger Frequenzgang) reduziert.
- Ein Experimentieren mit dem Aufstellwinkel bietet sich an, denn die Ergebnisse sehen anders aus, wenn der Sprecher „außermittig“ zum Mikrofon steht.

TRATTO 950

GENERELLER BETRIEB UNTER MAC OS

Zur manuellen Regelung des Eingangspegels über die Systemeinstellungen Ihres Computers beachten Sie die folgenden Anleitungen zu Ihrem Betriebssystem bzw. Ihrer Geräteplattform.

Regelung des Eingangspegels an einem Mac-OS-Computer:

- Klicken Sie auf das Apple-Symbol oben links auf Ihrem Bildschirm und wählen Sie „Systemeinstellungen“.



- Klicken Sie auf „Sound“, um die Klangoptionen zu öffnen.

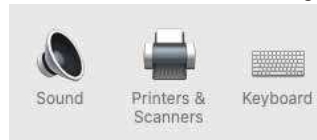

TRATTO 950

- Öffnen Sie die Registerkarte „Eingang“.

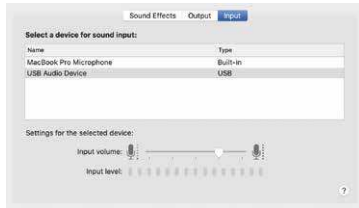

GENERELLER BETRIEB UNTER WINDOWS

Regelung des Eingangspegels an einem Windows-Computer:

- Öffnen Sie das Start-Menü und klicken Sie auf „Systemsteuerung“

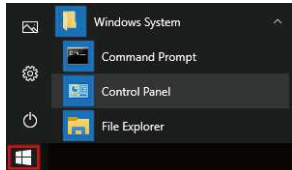

TRATTO 950

- Öffnen Sie darin die „Sound“-Einstellungen

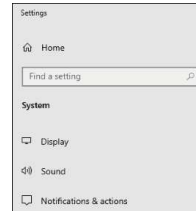

- Wählen Sie bei der Auswahl des Eingangs das Mikrofon

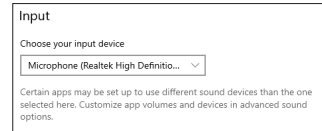

TRATTO 950

- 4 Stellen Sie mit dem Schieberegler den Eingangspegel ein.

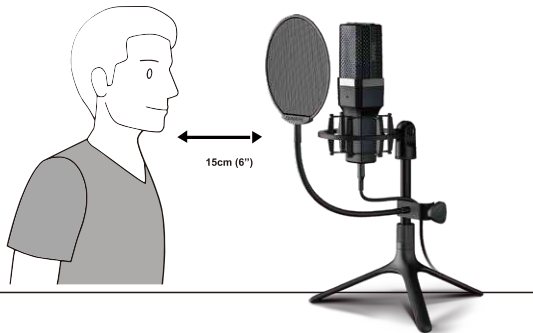
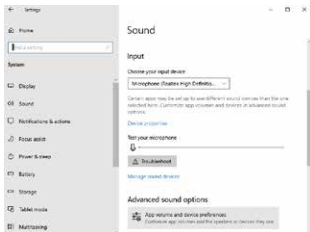

TRATTO 950

HINWEIS

- 1 Decken Sie das Mikrofongitter nicht mit Ihrer Hand ab.
- 2 Zur Vermeidung eines Kurzschlusses wird eine regelmäßige Wartung empfohlen.

QWARE

STREAMING MIC

TRATTO 950

PC - LAPTOP

MANUAL DE INSTRUCCIONES



HOW TO INSTALL YOUR MICROPHONE

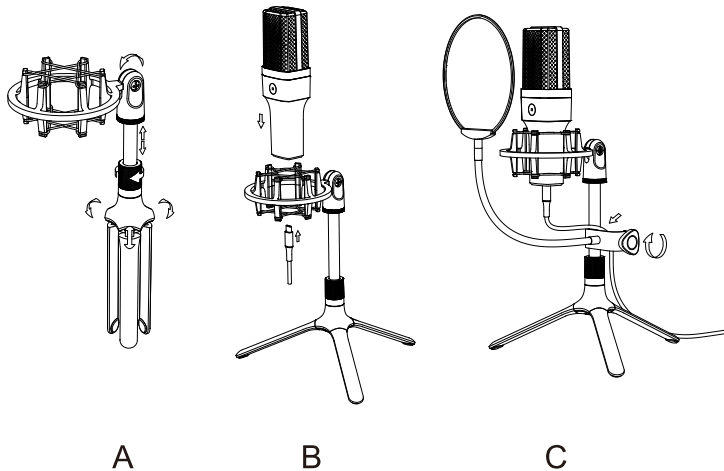

TRATTO 950

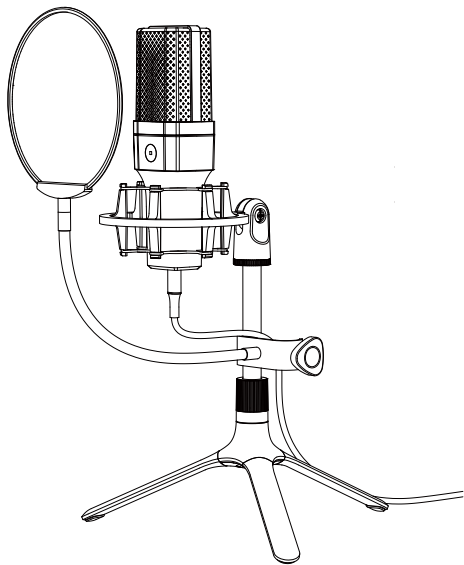

TRATTO 950



TRATTO 950

Contenido del paquete:

- Micrófono
- Soporte de trípode de metal
- Cable USB de 1,7 metros
- Filtro antipop
- Montaje flotante de alta calidad

Requisitos mínimos:

- PC o portátil con puerto USB
- Windows 7, 8, 10 o Mac OS x 10.5 (Leopard) o superior
- PS4™, PS5™

TRATTO 950



TRATTO 950

Especificaciones técnicas:

Cápsula de micrófono:	Condensador / capacitivo
Respuesta de frecuencia:	20Hz - 20kHz
Directividad:	Unidireccional (cardioide)
El nivel más alto:	83dB
Relación señal-a-ruido:	82dB
Sensibilidad:	-45dB ± 3dB
Línea de salida de audio:	Ø 4,5mm x 1,7m
Cable USB:	Conexión USB
Fuente de alimentación:	USB 5V CC

TRATTO 950

CARACTERÍSTICAS



CONFIGURACIÓN DEL MICRÓFONO



USB-C

- 1 Enchufar el cable USB-C en el puerto USB-C del micrófono y conectar el otro extremo al ordenador. Después de conectar el cable de audio, puede comenzar a trabajar directamente.

REQUISITOS DE POTENCIA

- 1 El micrófono es alimentado por el puerto USB de su dispositivo, lo que significa que en la mayoría de situaciones puede simplemente conectar el micrófono y comenzar.
Para puertos USB no estándar, es posible que se requiera un concentrador USB con alimentación.
- 2 Este es un dispositivo USB "plug & play", compatible con ordenadores Windows y Mac. La ubicación del micrófono puede provocar resultados de grabación diferentes.

- 3 Un punto de partida ideal para la referencia es colocar el micrófono directamente frente al usuario a una distancia de 15 cm (6"). Mover el micrófono un poco más cerca hará que el sonido vocal sea más íntimo y completo, mientras que mover el micrófono hacia atrás le dará al sonido vocal un poco más 'aire' o sonido ambiente y reducirá el efecto de proximidad (aumento de los graves o respuesta de baja frecuencia cuando la fuente de sonido está muy cerca).
- 4 Se puede experimentar con el ángulo, cómo se coloca el micrófono, ya que se pueden lograr diferentes resultados cuando el usuario está "fuera del eje" del micrófono.

TRATTO 950

FUNCIONAMIENTO GENERAL MAC OS

Para ajustar manualmente su nivel de entrada a través de las preferencias del sistema de su ordenador, use las siguientes instrucciones acordes a la plataforma/sistema operativo de su dispositivo.

Ajuste del nivel de entrada en un ordenador Mac OS:

- 1 Haga clic en el símbolo de Apple en la parte superior izquierda de su pantalla y seleccione Preferencias del sistema.



- 2 Haga clic en 'Sonido' para abrir las opciones de sonido

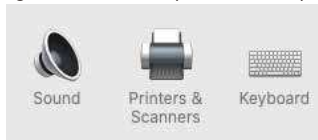

TRATTO 950

- 3 Abra la 'pestaña Entrada'.
- 4 Desde aquí, seleccione el 'Dispositivo de audio USB' de la lista de dispositivos y ajuste el nivel de entrada utilizando el control deslizante.

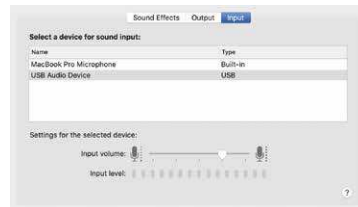

VENTANAS DE FUNCIONAMIENTO GENERAL

Ajuste del nivel de entrada en un ordenador con Windows:

- 1 Abra el menú Inicio y haga clic en 'Panel de control'

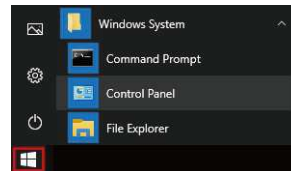

TRATTO 950

- 2 Abra las preferencias de 'Sonido' desde la carpeta 'Panel de control'

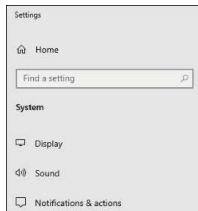

- 3 Elija el micrófono en la pantalla de entrada

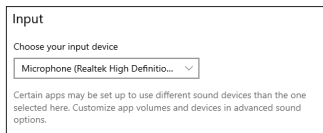

TRATTO 950

- 4 Ajuste el nivel de volumen utilizando el control deslizante.

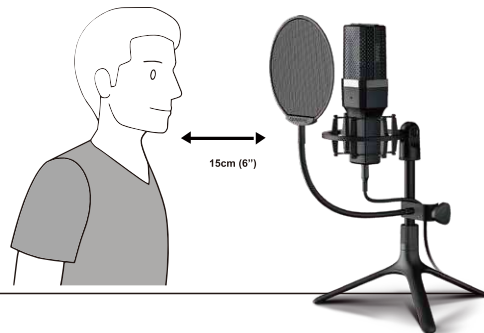
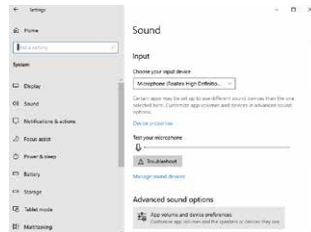

TRATTO 950

NOTA

- 1 No cubra la rejilla del micrófono con la mano.
- 2 Se recomienda un mantenimiento regular para evitar cortocircuitos.

QWARE

STREAMING MIC

TRATTO 950

PC - LAPTOP

MODE D'EMPLOI



HOW TO INSTALL YOUR MICROPHONE

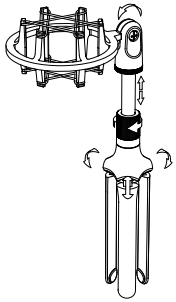

A

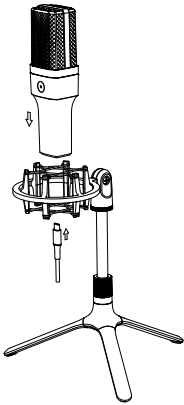

B

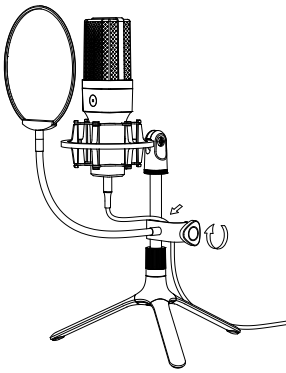

C

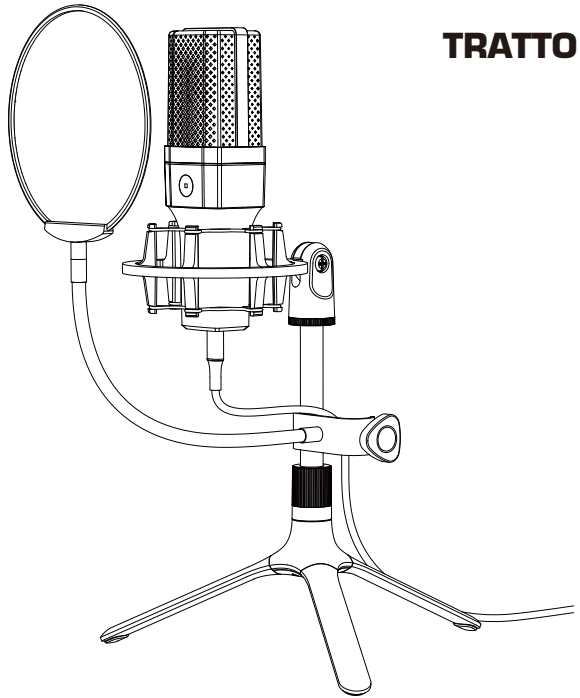

TRATTO 950

TRATTO 950



TRATTO 950

Contenu de l'emballage :

- Microphone
- Trépied en métal
- Câble USB de 1,7 m
- Bonnette
- Monture haut de gamme avec système antichoc

Système requis :

- PC ou portable avec port USB
- Windows 7, 8, 10 ou Mac OS x 10.5 (Leopard) ou supérieur
- PS4™, PS5™

TRATTO 950



5

TRATTO 950

Caractéristiques techniques :

Capsule de microphone :	condensateur/capacitive
Réponse en fréquence :	20 Hz - 20 kHz
Directivité :	unidirectionnelle (cardioïde)
Niveau maximal :	83 dB
Rapport signal/bruit :	82 dB
Sensibilité :	-45 dB \pm 3 dB
Ligne de sortie audio :	\varnothing 4,5 mm x 1,7 m
Câble USB :	connecteur USB
Alimentation électrique :	USB CC 5 V

6

TRATTO 950

FONCTIONNALITÉS

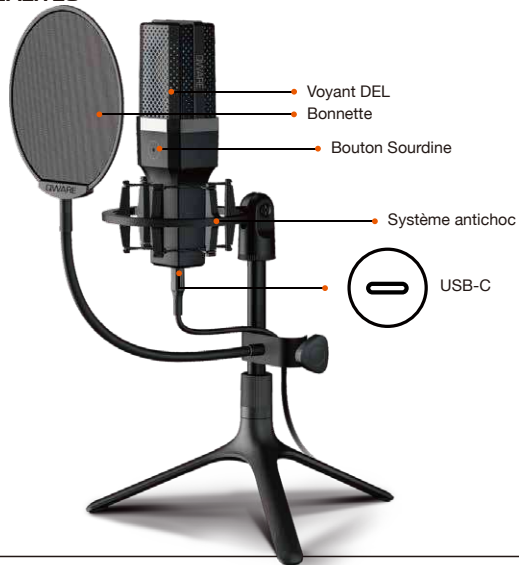

7

TRATTO 950

INSTALLATION DU MICROPHONE



- 1 Connectez une extrémité du câble USB-C au port USB-C du microphone et l'autre extrémité à votre ordinateur. Après avoir raccordé le câble audio, vous pouvez directement commencer à travailler.

ALIMENTATION REQUISE

- 1 Le microphone est alimenté par le port USB de votre appareil, autrement dit, dans la plupart des situations, il vous suffit de brancher le microphone.

Pour les ports USB non standards, un hub USB alimenté peut être nécessaire.

- 2 Cet appareil USB est un appareil « Plug & Play », compatible avec les ordinateurs Windows et Mac. La position du microphone peut influencer sur le résultat d'enregistrement.

8

TRATTO 950

- 3 Pour commencer, placez le micro directement devant l'utilisateur, à une distance de 15 cm (6"). Rapprocher le micro donnera un son plus plein et intime à votre voix et l'éloigner donnera un effet plus « aéré » ou espacé et réduira l'effet de proximité (la réponse en basses fréquences est accrue lorsque la source du son est très proche).
- 4 Vous pouvez faire des essais en jouant sur l'angle, la position du microphone, car en vous « désaxant » du microphone, vous pourrez atteindre différents résultats.

TRATTO 950

UTILISATION GÉNÉRALE MAC OS

Pour ajuster manuellement le niveau d'entrée à partir de vos préférences système, suivez les instructions suivantes en fonction de votre appareil/système d'exploitation.

Ajuster le niveau d'entrée sur un ordinateur Mac OS :

- 1 Cliquez sur le symbole Apple en haut à gauche de votre écran et sélectionnez Préférences système.

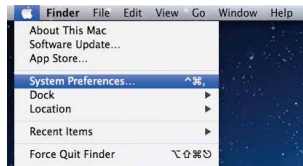

- 2 Cliquez sur « Son » pour ouvrir les options de son

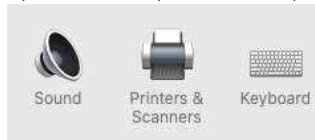

TRATTO 950

- 3 Ouvrez l'onglet « Entrées ».
- 4 Ici, sélectionnez « Périphérique USB audio » dans la liste des périphériques et ajustez le niveau d'entrée à l'aide du curseur.

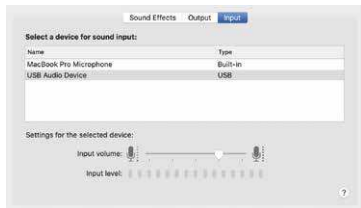

UTILISATION GÉNÉRALE WINDOWS

Ajuster le niveau d'entrée sur un ordinateur Windows :

- 1 Ouvrez le menu démarrer et cliquez sur « Panneau de configuration »

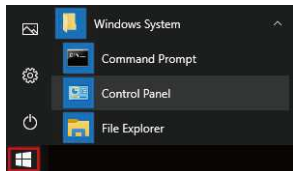

TRATTO 950

- 2 Ouvrez les préférences de son depuis le « Panneau de configuration »

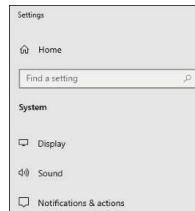

- 3 Choisissez le micro sur l'écran des entrées

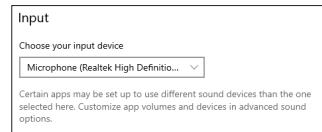

TRATTO 950

- 4 Ajustez le niveau d'entrée à l'aide du curseur.

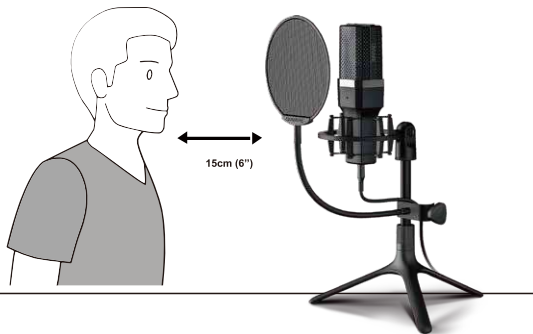
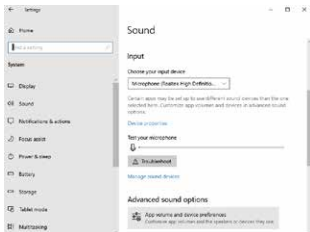

TRATTO 950

REMARQUE

- 1 Ne recouvrez pas la grille du microphone avec votre main.
- 2 Une maintenance régulière est recommandée pour éviter les courts-circuits.

TRATTO 950

Pirox Internationa B.V.

EC Declaration of Conformity

We
Pirox International B.V.
Blaak 6 | 3011 TA Rotterdam | The Netherlands

Hereby declare under our sole responsibility that the product:

Model number: QW GMI-950
Product description: Qware Gaming Microphone Tratto

To which this declaration relates is in conformity with the requirements of the following standards:

The EMC directive 2014/30/EU;

EN 55032: 2015+A11: 2020
EN 55035:2017

ROHS directive (EU) 2015/863 amending annex II to directive 2011/65/EU

REACH directive (EC) No.1907/2006 to determine 205 substances of very high concern (SVHC)

This certifies that the following designated product:

Model number: QW GMI-950
Product description: Qware Gaming Microphone Tratto
Complies with the requirements of the following directives and carries the CE marking accordingly:

The EMC directive 2014/30/EU
ROHS directive (EU) 2015/863 amending annex II to directive 2011/65/EU
REACH directive (EC) No.1907/2006

This declaration is the responsibility of the manufacturer / importer:

Pirox International B.V.
Rotterdam, 1 March, 2021



R.J. de Bruin,
CEO

