TROUBLESHOOTING

If your device does not respond to your Universal there may be a simple explanation such as a dead battery or an unsuccessful pairing. Please use the following to help troubleshoot your situation. If none of the following solve your issue, then please contact ZAGG Customer Service and one of our trained professionals will be happy to assist you.

1. Restart your device and re-pair your Universal.
2. Turn your Universal off and back on. You should see the LED status lights illuminate briefly, if not, charge your Universal.
3. After charging, turn your Universal on. If the LED status lights do not illuminate, and your keyboard doesn't operate correctly, please contact ZAGG's Customer Support.
4. Forget and re-pair your Universal. Review your device's instructions for how to properly forget a device, and then follow the directions under Pairing Your Universal.
5. If your device gives you an error message during pairing, repeat the pairing process.
8. If you still can't get your Universal to pair, it is possible your device needs to have its software updated. Consult your device's instructions for directions on how to update its software.
9. After your update is complete, repeat the troubleshooting/pairing process*.

* If you continually receive the same error message during pairing, or the above steps don't work, please contact ZAGG's Customer Support for assistance.



FOR MORE HELP PLEASE SEE OUR FAQ AT: www.ZAGG.com/faq
To reach a trained customer service representative, please use one of the following:
ZAGG.com/support/contact.php | questions@zagg.com
1-800-700-ZAGG [9244] | 00-1-801-839-3906 for international customers

For unparalleled scratch protection for your device, we recommend ZAGG's invisibleSHIELD.*

©2005 - 2013 ZAGG Inc. All Rights Reserved.
PATENT PENDING | NASDAQ: ZAGG | MADE IN CHINA
ZAGG*, invisibleSHIELD*, and ZAGGkeys™ Universal are trademarks or registered trademarks of ZAGG Inc.
This device complies with part 15 of the FCC Rules. Operation is subject to the following two conditions:
1: This device may not cause harmful interference, and 2: This device must accept any interference received, including interference that may cause undesired operation

*WARRANTY REGISTRATION

Your ZAGGkeys™ Universal comes with a one-year manufacturer's warranty. In order to activate the warranty, you must register your Universal as well as keep your purchase receipt. If you purchased your ZAGGkeys Universal from ZAGG.com, ZAGG* has already registered it and has a copy of your proof of purchase.

NEED MORE HELP? PLEASE SEE OUR FAQ SECTION AT:
www.ZAGG.com/faq

CONGRATULATIONS

Congratulations on being the proud new owner of the most versatile Bluetooth® keyboard available. The ZAGGkeys Universal pairs with any of your Android, Windows, or iOS devices*. Read the following instructions in their entirety as some functions of the Universal work differently depending on the device you are using. Keep these instructions for future reference.

***Not all functions work, or work the same, across all operating systems and/or across all devices within an operating system. Please refer to the device specific tables under Special Function Keys for information on specific system key functions.**

QUICK START

Your ZAGGkeys Universal is ready to go right out of the box. Simply follow these steps to begin enjoying the Universal with any of your devices.

1. Remove the Universal from its packaging.

2. Slide the Universal Bluetooth® keyboard out of its protective cover by securing the cover and then sliding out the keyboard by pushing it to one side or the other.

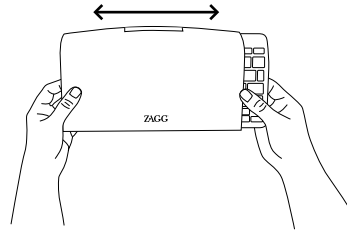

3. Place the Universal keyboard in an ideal typing location.

4. How to open the built-in device stand.

- Hold the protective cover in one hand with your thumb on the ZAGG logo that appears on the outside of the cover.

- Place your other hand on the opposite side of the cover with your finger/s inside the cover on the edge of the hinged stand.

- Press outward with your fingers so that the hinged stand moves toward your thumb.

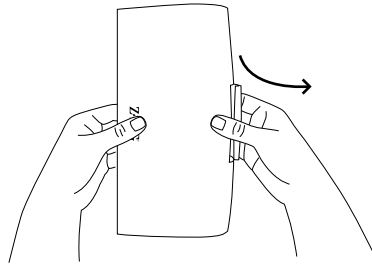

5. Place the stand so that the now exposed trough sits on a flat surface.

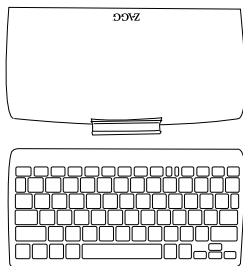

6. Set your device in the trough (you can choose portrait or landscape mode)

7. Turn on your ZAGGkeys Universal using the power switch on the right hand side.

8. Select your operating system using the selector switch on the underside of the Universal keyboard.

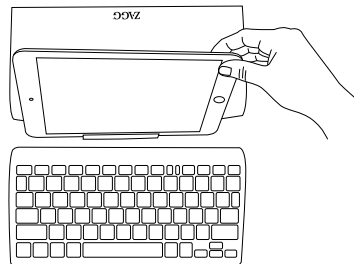

9. Pair the Universal with your device (for information on pairing, see Pairing Your Universal).

10. Enjoy the ease and comfort of your Universal.

WINDOWS DEVICE

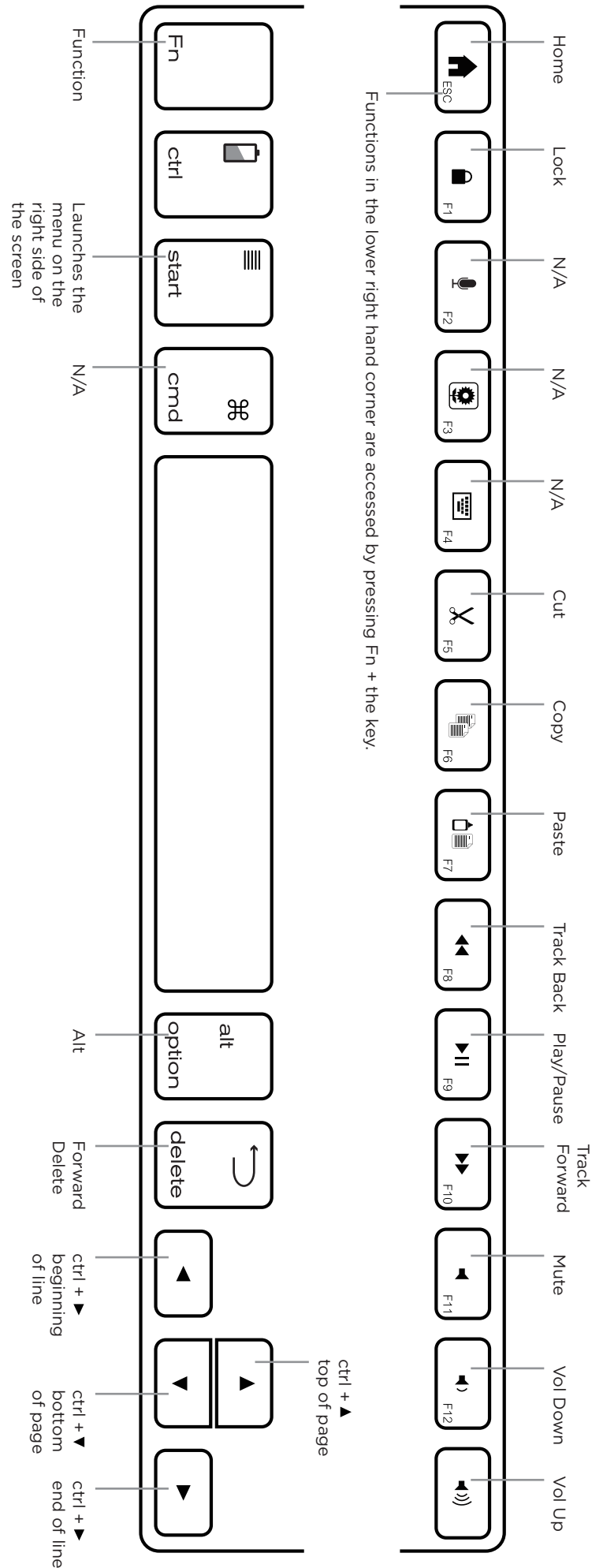

CHARGING

Your Universal features a powerful lithium-ion battery that lasts for up to three months of normal use between charges. It comes with a charging cable you can use to charge your keyboard quickly and conveniently. To charge your Universal, simply follow these steps:

1. Plug the micro USB connector into the charging port.
2. Plug the regular USB connector into any USB outlet (including a ZAGGsparq™, your computer, your device, etc.).
3. A green LED light will illuminate to indicate the Universal is charging. Wait until this light turns off, indicating a full charge. It usually takes 2-4 hours to completely charge your Universal.
4. Remove the Micro USB connector and enjoy your Universal for up to three months before you need to charge it again.

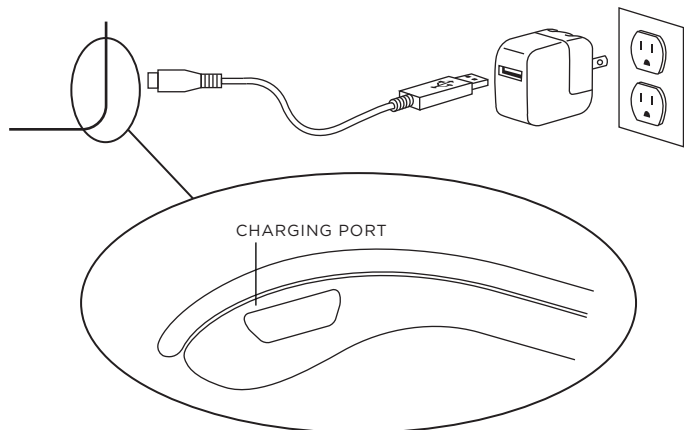

BATTERY LIFE

As mentioned, the Universal features a powerful, rechargeable battery that lasts up to three months between charges*. To check your Universal's remaining battery power, simply hold down the function (fn) key and press the battery key (also the CTRL key). The LED indicator will flash one of three ways.

1. Three green flashes indicate 50% or more battery life remaining.
2. Three yellow flashes indicate between 25%-50% battery life remaining.
3. Three red flashes indicate less than 25% battery life remaining. When your Universal reaches critical battery level the red light will flash once every five minutes.

To help preserve battery life, your Universal will enter sleep mode if left on and not used for several minutes. To wake your Universal, simply press any key. The Universal's battery has no memory and therefore may be charged whenever you wish. For optimal battery life, we recommend turning your Universal off when idle for a prolonged time.

SPECIAL FUNCTION KEYS

Your Universal has a variety of special function keys. However, not all keys work with each operating system*. Please refer to the diagrams below to learn more about the special function keys that work with your device.

*Not all functions work, or work the same, across all operating systems and/or across all devices within an operating system. Please refer to the device specific tables for information on specific system key functions.

APPLE DEVICE

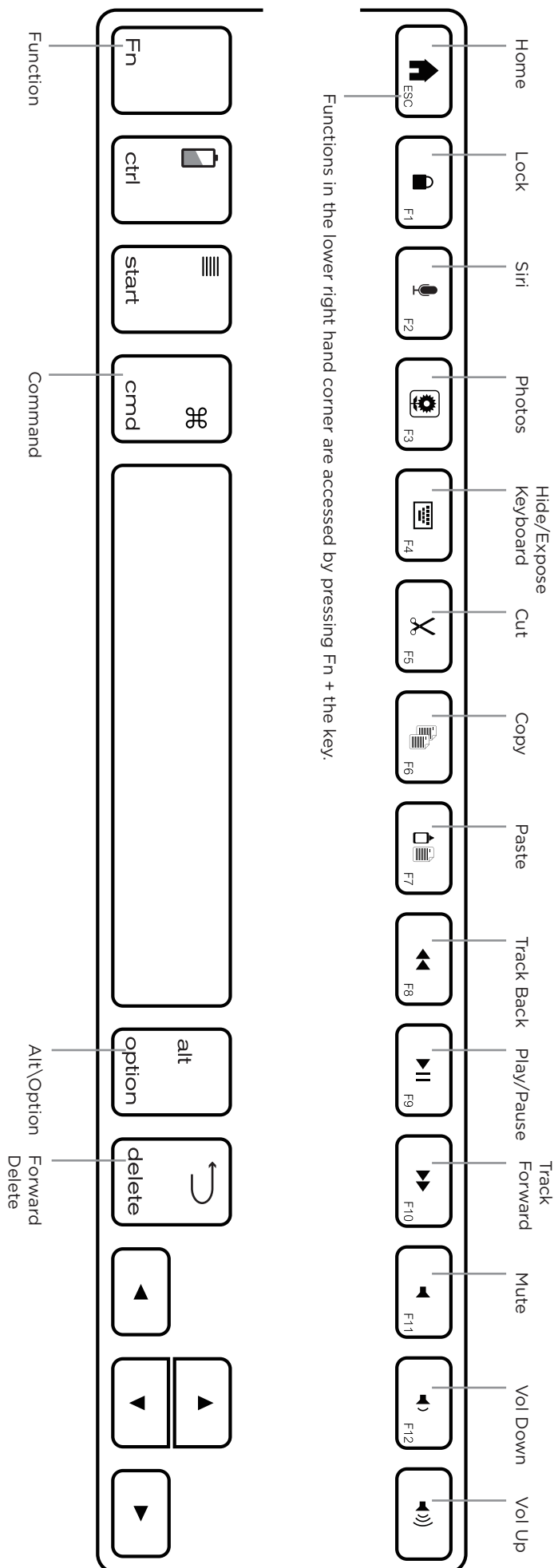

ANDROID DEVICE

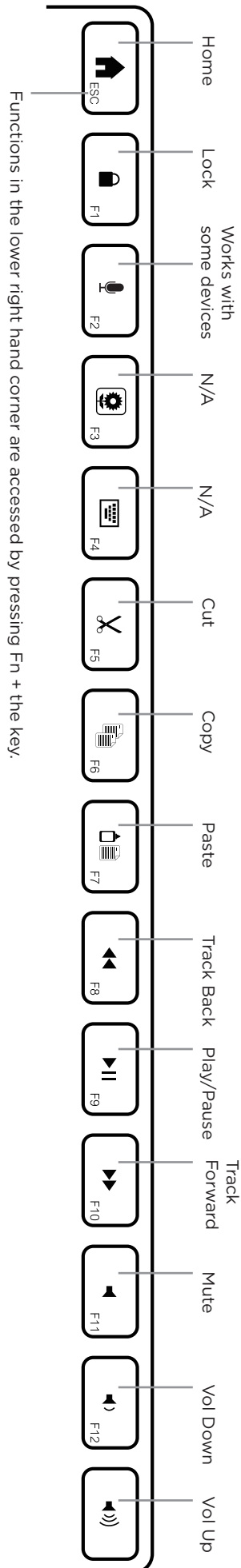
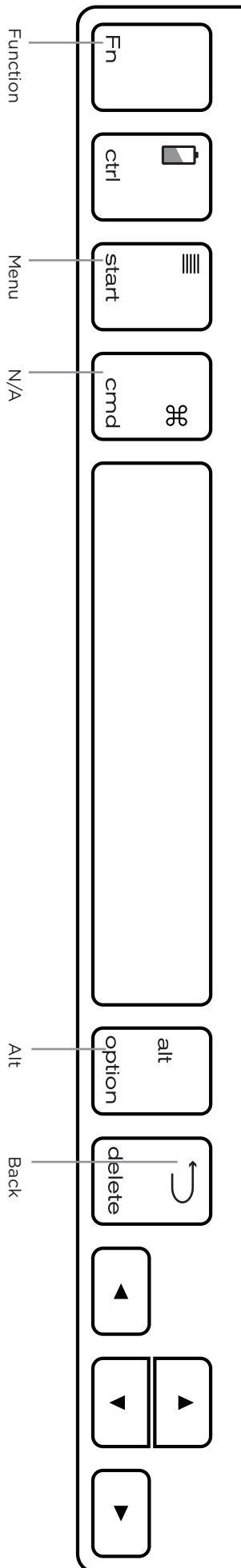

POWERING ON AND OFF

The Universal comes ready to go with about 80% of the battery charged. To turn it on, simply slide the power button to the ON position, you'll see a green dot. A blue LED light will flash on the CAPS LOCK key and a green LED will flash on the fn key. To turn your Universal off, simply switch the power button to the OFF position, you'll see a red dot.

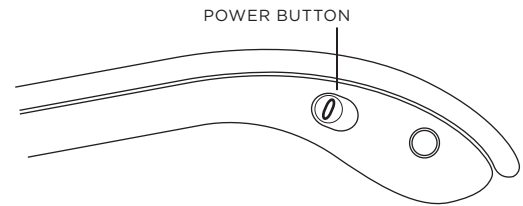

PAIRING YOUR UNIVERSAL

Each time you switch devices, especially one with different operating systems, you'll need to pair your Universal. To pair it, make sure it is turned on and then find your operating system below and follow the directions.

FOR ANDROID

1. Select SETTINGS > WIRELESS & NETWORKS > BLUETOOTH > ON
2. Press the Pair button on your Universal keyboard. A blue LED light will flash until your device and the Universal are paired.
3. Your device should find the Universal and then list it as an available device. If it doesn't, simply touch Search for devices and it will scan again.
4. When the Universal shows in your list of available devices, touch it to complete pairing.

FOR iOS

1. On your device select: SETTINGS > GENERAL > BLUETOOTH > ON.
2. Press the Pair button on your Universal keyboard. A blue LED light will flash until your device and the Universal are paired.
3. Your device will display "ZAGGkeys Universal" as an available device. Select this option to complete pairing.

FOR WINDOWS

1. Press the Pair button on your Universal keyboard. A blue LED light will flash until your device and the Universal are paired.
2. If you have it, touch the Bluetooth symbol in your system tray* and select Add a Device. If you don't have the Bluetooth symbol available, simply touch the Start button and then choose Devices. From this menu you can choose Add a Device.
3. The Universal should show up as an available device; select it and touch Next to complete pairing.

*Windows 8 users can use the Settings charm.

