

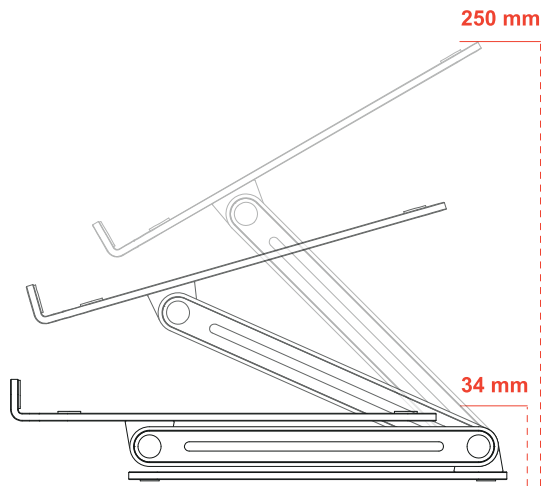

Product hoogte

Product height



 De bovenstaande hoogte is het beschikbare bereik voor de laptop standaard, maar niet de hoogst instelbare maat. Gebruik de afbeelding als leidraad en houdt het apparaat veilig.

 Use the height that is used above as a guideline for the range for the laptopstand, it is not the highest adjustable range. Please use this as an usage example and keep your device safe.

Onderdelen

Parts

 Moersleutel

 Wrench

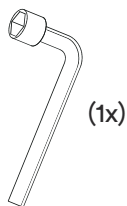

Design made simple.



VEMNI Essentials

Laptop Stand

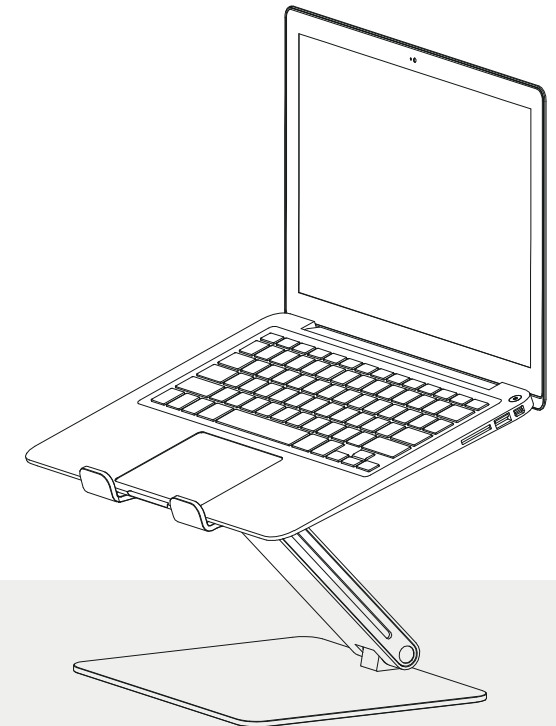

Infinitely Adjustable

Ventilated Construction | Ergonomic design

Aluminum Made | Made for 9.7" - 17"

Toepassing

Application

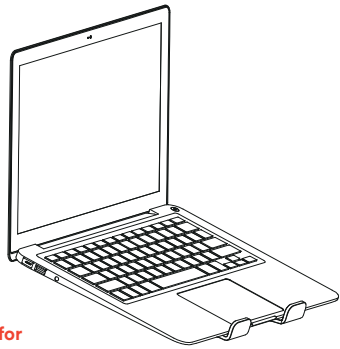

Gemaakt voor / Made for
11-17" Laptop

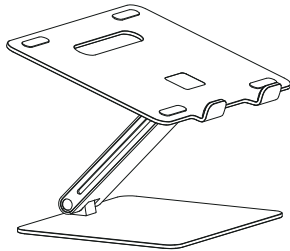

 Werkt met de meeste laptops,
boeken en tablets.

 Compatible with the majority
of laptops, books and tablets.

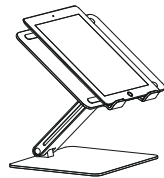
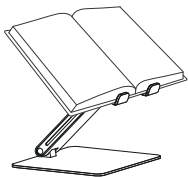
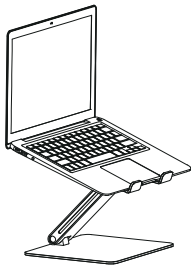

Oneindig verstelbaar

Infinitely adjustable

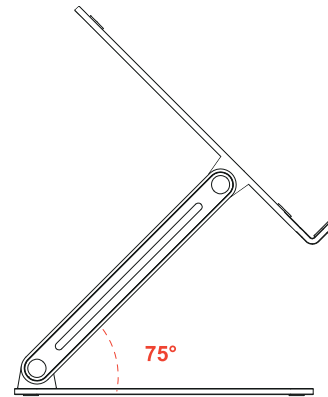
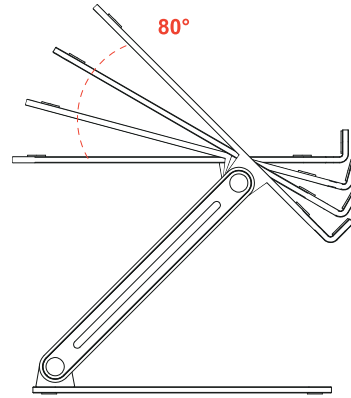

Infinitely Adjustable



Aanpasbare wrijving

Friction adjustment



Attentie: Als je het gevoel hebt dat de wrijving goed is afgesteld, negeer dan deze stap.

Note: if you feel everything is smoothly,
Please ignore this step.

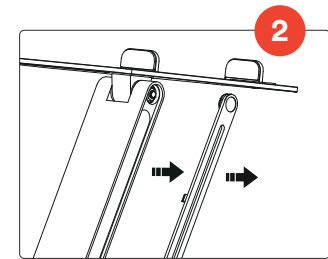
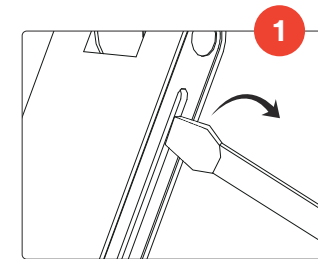

 wrik één zijpaneel open zoals hierboven afgebeeld.
(Zorg zelf voor een platte schroevendraaier)

 Pry open one side cover as above pictures.
(Prepare the tool by yourself)

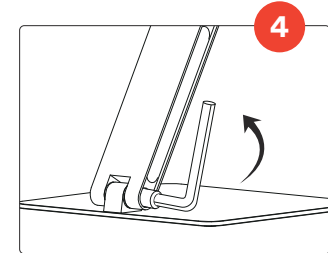
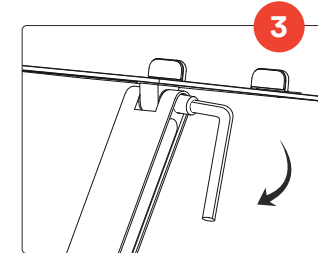

 Als de laptop standaard tijdens gebruik te strak
of te los aanvoelt, pas dan de schroef aan.

 If the laptop stand feels too tight or too loose
during use, adjust the screw.

