

BOSE[®]

 SoundTouch™ 30/20 series III
wireless music systems



Owner's Guide

Important Safety Instructions

Please take the time to carefully read and follow these Important Safety Instructions. They will help you set up and operate your system properly and enjoy its advanced features. Save this guide for future reference.



The lightning flash with arrowhead symbol within an equilateral triangle alerts the user to the presence of uninsulated, dangerous voltage within the system enclosure that may be of sufficient magnitude to constitute a risk of electric shock.



The exclamation point within an equilateral triangle alerts the user to the presence of important operating and maintenance instructions in the owner's guide.



WARNINGS:

- To reduce the risk of fire or electric shock, do not expose this product to rain or moisture.
 - Do not expose this apparatus to dripping or splashing, and do not place objects filled with liquids, such as vases, on or near the apparatus. As with any electronic products, use care not to spill liquids into any part of the product. Liquids can cause a failure and/or a fire hazard.
-



CAUTIONS:

- Keep new and used batteries away from children. Do not ingest battery, chemical burn hazard. The remote control supplied with this product contains a coin/button cell battery. If the coin/button cell battery is swallowed it can cause severe internal burns in just 2 hours and can lead to death. If the battery compartment does not close securely, stop using the product. If you think the battery may have been swallowed or placed inside any part of the body seek immediate medical attention. May explode or cause a fire or chemical burn if incorrectly replaced or mishandled. Do not recharge, disassemble, heat above 212°F (100°C), or incinerate. Replace only with an agency approved (ex. UL) CR2032 or DL2032 3-volt lithium battery. Dispose of used batteries promptly.
 - Do not place naked flame sources, such as lighted candles, on or near the apparatus.
-



WARNING: Contains small parts which may be a choking hazard. Not suitable for children under age 3.



Please dispose of used batteries properly, following local regulations. Do not incinerate.



This symbol means the product must not be discarded as household waste, and should be delivered to an appropriate collection facility for recycling. Proper disposal and recycling helps protect natural resources, human health and the environment. For more information on disposal and recycling of this product, contact your local municipality, disposal service, or the shop where you bought this product.

Important Safety Instructions



The product contains magnetic material. Please contact your physician if you have any questions on whether this might affect the operation of your implantable medical device.



CAUTION: Make no modifications to the system or accessories. Unauthorized alterations may compromise safety, regulatory compliance, and system performance.

NOTES:

- Where the mains plug or appliance coupler is used as the disconnect device, such disconnect device shall remain readily operable.
- This product must be used indoors. It is neither designed nor tested for use outdoors, in recreation vehicles, or on boats.
- The product label can either be located on the back or bottom of the system.

Important Safety Instructions

1. Read these instructions.
2. Keep these instructions.
3. Heed all warnings.
4. Follow all instructions.
5. Do not use this apparatus near water or moisture.
6. Clean only with a dry cloth.
7. Do not block any ventilation openings. Install in accordance with the manufacturer's instructions.
8. Do not install near any heat sources, such as radiators, heat registers, stoves, or other apparatus (including amplifiers) that produce heat.
9. Protect the power cord from being walked on or pinched, particularly at plugs, convenience receptacles, and the point where they exit from the apparatus.
10. Only use attachments/accessories specified by the manufacturer.
11. Unplug this apparatus during lightning storms or when unused for long periods of time.
12. Refer all servicing to qualified service personnel. Servicing is required when the apparatus has been damaged in any way: such as power supply cord or plug is damaged; liquid has been spilled or objects have fallen into the apparatus; the apparatus has been exposed to rain or moisture, does not operate normally, or has been dropped.

Regulatory Information

Information about products that generate electrical noise

This equipment has been tested and found to comply with the limits for a Class B digital device, pursuant to Part 15 of the FCC rules. These limits are designed to provide reasonable protection against harmful interference in a residential installation. This equipment generates, uses, and can radiate radio frequency energy and, if not installed and used in accordance with the instructions, may cause harmful interference to radio communications. However, there is no guarantee that interference will not occur in a particular installation. If this equipment does cause harmful interference to radio or television reception, which can be determined by turning the equipment off and on, the user is encouraged to try to correct the interference by one or more of the following measures:

- Reorient or relocate the receiving antenna.
- Increase the separation between the equipment and receiver.
- Connect the equipment to an outlet on a different circuit than the one to which the receiver is connected.
- Consult the dealer or an experienced radio/TV technician for help.

FCC WARNING

Changes or modifications not expressly approved by Bose Corporation could void the user's authority to operate this equipment.

Important USA and Canada compliance Information

This device complies with part 15 of the FCC rules and Industry Canada license-exempt RSS standard(s). Operation is subject to the following two conditions: (1) this device may not cause harmful interference, and (2) this device must accept any interference received, including interference that may cause undesired operation.

This equipment complies with FCC and Industry Canada radiation exposure limits set forth for an uncontrolled environment. This equipment should be installed and operated with a minimum distance of 20 cm between radiator and your body.

This equipment must not be co-located or be operating in conjunction with any other antennas or transmitters.

This device complies with Industry Canada licence-exempt RSS standards(s).

This Class B digital apparatus complies with Canadian ICES-003.

CAN ICES-3 (B)/NMB-3(B)

 Bose Corporation hereby declares that this product is in compliance with the essential requirements and other relevant provisions of Directive 1999/5/EC and all other applicable EU directive requirements. The complete declaration of conformity can be found at: www.Bose.com/compliance

Regulatory Information

Names and Contents of Toxic or Hazardous Substances or Elements						
Part Name	Toxic or Hazardous Substances and Elements					
	Lead (Pb)	Mercury (Hg)	Cadmium (Cd)	Hexavalent (CR(VI))	Polybrominated Biphenyl (PBB)	Polybrominated diphenylether (PBDE)
PCBs	X	0	0	0	0	0
Metal parts	X	0	0	0	0	0
Plastic parts	0	0	0	0	0	0
Speakers	X	0	0	0	0	0
Cables	X	0	0	0	0	0

This table is prepared in accordance with the provisions of SJ/T 11364.
 O: Indicates that said hazardous substance contained in all of the homogeneous materials for this part is below the limit requirement of GB/T 26572.
 X: Indicates that said hazardous substance contained in at least one of the homogeneous materials used for this part is above the limit requirement of GB/T 26572.

Please complete and retain for your records

The serial and model number can be found on the back or bottom of the system.

Serial number: _____

Model number: _____

Purchase date: _____

We suggest you keep your receipt in a safe place.

App Store is a service mark of Apple Inc.

Amazon, Kindle and Fire are trademarks of Amazon.com, Inc. or its affiliates.

Android and Google Play are trademarks of Google Inc.

The *Bluetooth*® word mark and logos are registered trademarks owned by Bluetooth SIG, Inc. and any use of such marks by Bose Corporation is under license.



iHeartRadio is a registered trademark of iHeartMedia, Inc.

This product incorporates Spotify software which is subject to 3rd party licenses found here: www.spotify.com/connect/third-party-licenses.

Spotify is a registered trademark of Spotify AB.

SoundTouch and the wireless note design are trademarks of Bose Corporation in the U.S. and other countries.

Wi-Fi is a registered mark of the Wi-Fi Alliance.

Windows is a registered trademark of Microsoft Corporation in the United States and other countries.

© 2015 Bose Corporation. No part of this work may be reproduced, modified, distributed, or otherwise used without prior written permission.

Contents

SoundTouch™

System benefits.....	8
Hardware features.....	8
SoundTouch™ app	8

Setting up the System

Unpacking the system.....	9
Connecting the system to power	10
Adding the system to your Wi-Fi® network	10
Add the system to an existing SoundTouch™ account.....	10
Download and install the SoundTouch™ app.....	11
Connect the system to your home Wi-Fi® network.....	11
Connecting the system to a new network.....	11

Using the System

Powering on the system.....	12
Getting system information.....	12
Messages on the display.....	13
Wi-Fi® indicator.....	13
System control buttons	14
Using the  AUX button.....	15

Controlling the System using the App

Using the SoundTouch™ app	16
Getting help.....	16
Controlling the system from another smartphone, tablet, or computer	16

Personalizing your Presets

How Presets work	17
What you need to know.....	17
Playing a Preset	17
Setting a Preset	18

Bluetooth®

Pairing a <i>Bluetooth</i> ® enabled device.....	19
Connecting to a paired <i>Bluetooth</i> ® enabled device.....	21
Using the  AUX button.....	21
Using the Bluetooth ® feature on the paired device	21
Clearing the system's Bluetooth ® pairing list.....	21

Connecting a Device to the AUX IN Connector

Using a cable to connect an audio device.....	22
---	----

Advanced Features

Updating system software	23
Disabling Wi-Fi® capability.....	23
Re-enabling Wi-Fi® capability.....	24
Resetting the system	24

Care and Maintenance

Troubleshooting	25
Getting diagnostic information	26
Cleaning.....	26
Replacing the remote control battery	27
Customer service.....	28
Limited warranty information.....	28

Technical Information

SoundTouch™ 30 system	29
SoundTouch™ 20 system	29

Appendix: Using a Computer for Setup

Important setup information.....	30
Using a desktop computer for setup	30
Setting up the system using a computer	30

SoundTouch™

Your SoundTouch™ wireless music system provides clear, room-filling sound streamed wirelessly over your home Wi-Fi network. With SoundTouch™, you can stream Internet radio, music services, and your music library.

If you have Wi-Fi at home, you're ready to enjoy your favorite music in any room you want.

System benefits

- Enjoy wireless access to Internet radio, music services and your music library.
- Access your favorite music easily with your personalized Presets.
- Wireless setup using your smartphone or tablet.
- Works with your existing home Wi-Fi network.
- Stream music from *Bluetooth*® enabled devices.
- Free SoundTouch™ app for your computer, smartphone, or tablet.
- Simply add additional systems at any time for a multi-room listening experience.
- Wide selection of Bose® audio systems lets you choose the right solution for any room.

Hardware features

- Six Presets on the system and its remote deliver your music with just one touch.
- 1.6-in. display communicates system status and information.
- AUX connector enables playback from an audio device.
- Remote control for point-and-click control from up to 20 feet away.
- Thumbs up/Thumbs down buttons on remote control for customized listening.
- Ethernet connector enables wired access to your home network.

SoundTouch™ app

- Set up and control your system from your smartphone, tablet, or computer.
- Use the SoundTouch™ app to easily personalize Presets to your favorite music.
- Explore Internet radio, music services and your music library.
- Manage system settings

Setting up the System

Unpacking the system

Carefully unpack the carton and confirm that the following parts are included.

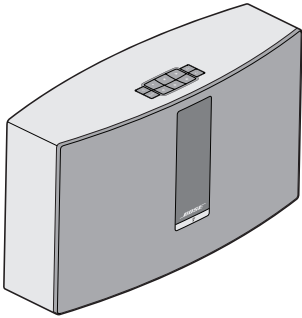

SoundTouch™ Wi-Fi® music system

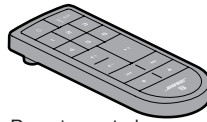

Remote control



USB cable
(computer setup only)

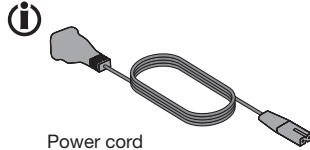

Power cord

i May ship with multiple power cords. Use the power cord for your region.

Note: If part of the system is damaged, do not use it. Contact your authorized Bose® dealer or Bose customer service. Refer to the quick start guide in the carton for contact information.

Save the carton and packing materials for transporting or storing the system.

Setting up the System

Connecting the system to power

Before you set up the system on your network, connect the system to power.

1. Plug the power cord into the **POWER** connector on the system.

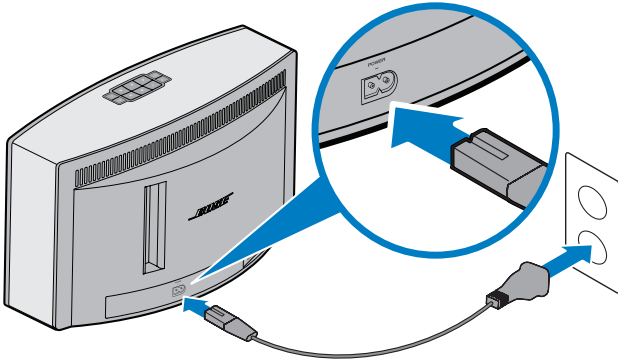

2. Plug the other end of the power cord into an AC (mains) power outlet.

Adding the system to your Wi-Fi® network

After you connect the system to power, you must download and install the SoundTouch™ app onto a smartphone or tablet that is connected to your network. The app guides you through connecting the system to your network.

Note: If you do not have a smartphone or tablet, you can use a computer for setup. See page 30.

Add the system to an existing SoundTouch™ account

If you have already set up SoundTouch™ for another system, you do not need to download the SoundTouch™ app again.

1. On your smartphone or tablet, select the SoundTouch™ icon  to launch the app.
2. Select **EXPLORE > SETTINGS > Systems > ADD SYSTEM** to add another system.

The app guides you through setup.

Download and install the SoundTouch™ app

If this is your first time setting up a SoundTouch™ system, you must install the app. On your smartphone or tablet, download the **SoundTouch™ controller app**.



- iOS users: download from the App Store
- Android™ users: download from the Google Play™ store
- Amazon Kindle Fire users: download from the Amazon Appstore for Android

Connect the system to your home Wi-Fi® network

After you install the app, add the system to your network:

1. On your smartphone or tablet, select  to launch the app.
The app guides you through connecting the system to your Wi-Fi® network.
2. Follow the instructions in the app to complete setup, including creating SoundTouch™ account, adding a music library and music services.

Connecting the system to a new network

If your network information changes, you must add the system to the new network. You can do this by manually putting the system in to setup mode.

1. On the button pad, press and hold **2** and  until *Setup* appears on the display and the Wi-Fi indicator glows amber.

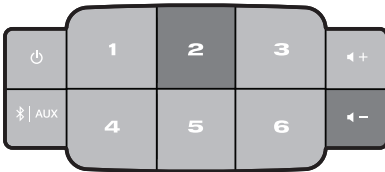

2. On your smartphone, tablet or computer, open the app.
3. From the EXPLORE panel, select **SETTINGS > Systems**.
4. Select your system.
The app guides you through setup.

Using the System

Powering on the system

On the button pad or the remote control, press **Power** (). The display may show an icon, message, or Now Playing information, depending on system state. For a list of icons that may appear on the display, see page 13.

Tip: You can also press a Preset or  | **AUX** to power on the system.

Getting system information

The front of the system shows information via the display and the Wi-Fi® indicator (see page 13).

- Display: shows system messages and Now Playing information.
- Wi-Fi indicator: shows Wi-Fi status.

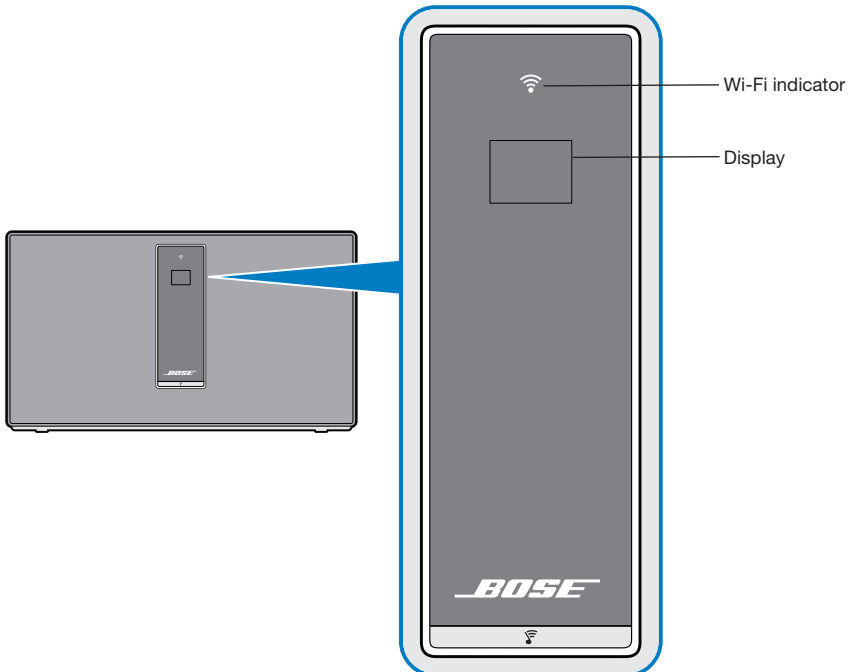

Front panel of the system

Messages on the display

The display shows system information and icons, and may include album or artist.

Display icon	Description
	Appears at initial power on. Instructs you to refer to setup instructions
	Internet radio is playing
	Volume is being adjusted
	Music library is playing
	Multi-room audio is active
AUX	Auxiliary mode is active
	Bluetooth® source is active
1 2 3 4 5 6	Preset is selected
	Skipping forward to the next track
	Skipping backward to the previous track
	Audio is paused
	Audio is stopped

Wi-Fi® indicator

The Wi-Fi® indicator () on the front of the system indicates the Wi-Fi connection status of the system.







Indicator activity	System state
Blinking white	Connecting to Wi-Fi network
Solid white (dim)	Power saving mode and connected to Wi-Fi network
Solid white (bright)	System is on and connected to Wi-Fi network
Blinking amber	Disconnected from Wi-Fi network
Solid amber	System is in setup mode
Off	Networking disabled or system connected to Ethernet

Using the System

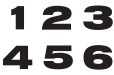
System control buttons

The system controls reside on the button pad and on the remote control. You can also control the system using the SoundTouch™ app (see page 16).

- Button pad: enables you to power the system, set and play your Presets, adjust the volume, and activate the *Bluetooth*® and auxiliary sources.
- Remote control: enables the same functionality as the button pad, plus: skip backward/skip forward and play/pause, and Thumbs up/Thumbs down.

Button	Description
	Power: Press to power on/off the system
	Six Preset buttons: <ul style="list-style-type: none">• Press and hold to set a Preset to what is currently playing• Press a Preset to play it
	<i>Bluetooth</i> /Auxiliary button: <ul style="list-style-type: none">• Press to toggle between the <i>Bluetooth</i> and auxiliary source• Icon or text on the display indicates source
	Volume Up/Volume Down: Press to increase/decrease volume
	Skip Backward/Skip Forward: Press to skip tracks (remote control only)
	<ul style="list-style-type: none">• Play/Pause: Press to toggle play or pause audio• Mute/Unmute: Press to mute or unmute a device connected to AUX (remote control only)
	<ul style="list-style-type: none">• Thumbs Up/Thumbs Down: Press to like/dislike the currently playing selection

Using the | AUX button

This multifunction button enables you to play more music on your system.

- Stream music from a connected *Bluetooth*® enabled device
- Connect an audio device to the AUX IN connector

Press  | **AUX** to toggle between *Bluetooth* () and auxiliary (**AUX**) sources.

***Bluetooth*® wireless technology**

Your system has *Bluetooth* wireless technology which lets you stream music from *Bluetooth* enabled devices to your system. Your system stores eight previously connected devices in its pairing list.

See page 19 for more information.

Auxiliary source

The auxiliary source lets you play music from an audio device connected to your system's AUX IN connector. You need a stereo cable with a 3.5 mm stereo cable plug (not provided).

See page 22 for more information.

Controlling the System using the App

Using the SoundTouch™ app

The SoundTouch™ app is a software application that enables you to set up and control SoundTouch™ from your smartphone, tablet, or computer. Using the app, your smart device acts as a rich remote for your SoundTouch™ system.

The app enables you to manage your SoundTouch™ settings, add music services, explore local and global Internet radio stations, set and change Presets, stream music to the system, view what is playing, plus much more.

After you set up the system on your network using the SoundTouch™ app, you are ready to explore streaming music and personalize your Presets.

Getting help

 [SoundTouch.com](https://www.soundtouch.com)

Provides access to the owner support center, which includes: owner's manuals, articles, tips, tutorials, a video library, and the owner community where you post questions and answers.

1. Open a browser.
2. In the address field, type **SoundTouch.com**

In-app help

Provides help articles for using SoundTouch™.

1. On your device, select  to open the app.
2. From the EXPLORE panel, select **HELP**.

Controlling the system from another smartphone, tablet, or computer

Once you set up the SoundTouch™ system on your home Wi-Fi® network, you can control the system from any smartphone, tablet, or computer on the same network.

1. Connect the device to the same network as your system.
2. On the device, download and install the SoundTouch™ app:
 - If you are using a smartphone or tablet, see page 11.
 - If you are using a computer, open a browser and go to:
SoundTouch.com/app

How Presets work

You can personalize six Presets to your favorite streaming music services, stations, playlists, artists, albums or songs from your music library. You can access your music, at any time, with a simple touch of a button on the SoundTouch™ system or its remote control.

Tip: You can also access your Presets using the SoundTouch™ app on your computer, smartphone, or tablet.

What you need to know

- You can set Presets from the app, the button pad and the remote control.
- If the Preset source is your iTunes or Windows Media Player music library, ensure the computer storing your music library is on and connected to the same network as the SoundTouch™ system.
- You cannot set Presets to a *Bluetooth*® stream or audio device connected to the AUX IN connector.

Playing a Preset

Once you personalize your Presets using the app, press a Preset on the button pad or on the remote control to play it. If you have not set your Presets, launch the app and set your Presets. For help, refer to the in-app help.

If using the remote control, aim the remote toward the system while pressing a Preset on the remote.

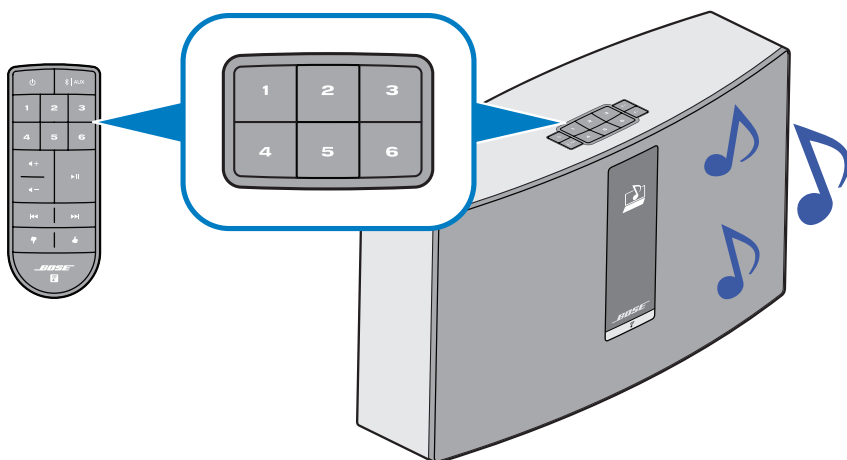

Music plays on the system. Information appears on the display, which may include an icon, song or station depending on the source. See page 13.

Note: If no music plays and a *Preset empty* message appears on the display, see “Setting a Preset” on page 18.

Personalizing your Presets

Setting a Preset

1. Stream music to the system using the app.
2. While the music is playing, press and hold a Preset on the button pad or remote control (about 2 seconds).

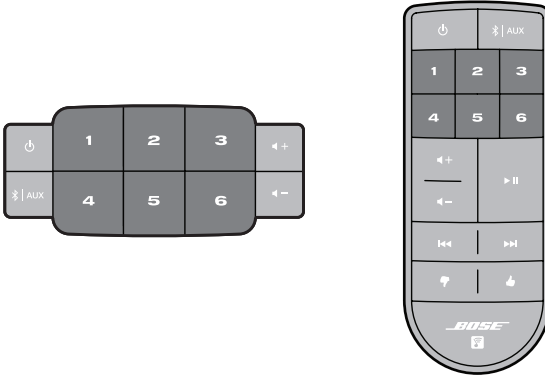

The system emits a tone when the Preset is set. A *New Preset assigned* message appears on the display.

Note: For information on using the SoundTouch™ app to set and change your Presets, refer to the in-app help.

Pairing a Bluetooth® enabled device

Bluetooth® wireless technology enables you to stream music from Bluetooth enabled smartphones, tablets, computers or other audio devices to your SoundTouch™ system. You can even stream music from Bluetooth enabled devices that are not part of your SoundTouch™ ecosystem, such as a guest's smartphone or tablet.

Before you can stream music from a Bluetooth enabled device, you must pair the device with your system.

1. On the system's button pad or remote control, press and release  | **AUX** until a Bluetooth pairing message appears on the display.

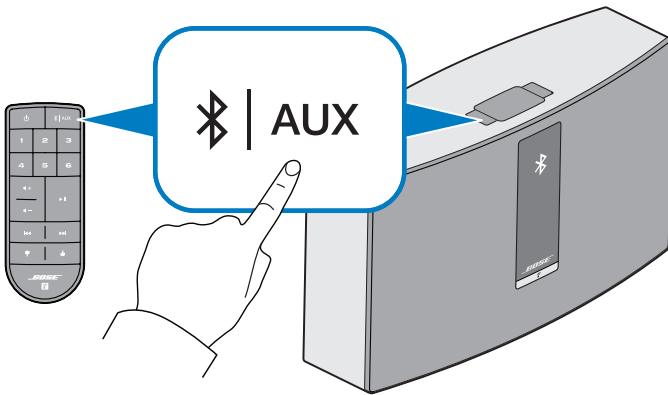

Note: Each time you press  | **AUX**, the system toggles between Bluetooth () and auxiliary (**AUX**) sources.

Tip: You can also press and hold  | **AUX** for two seconds to pair a device.

Make sure you see a Bluetooth message on the display before you pair your device.

Bluetooth®

2. On your *Bluetooth*® enabled device, turn on the *Bluetooth* feature.

Tip: The *Bluetooth* feature is usually found in Settings. A gear icon (⚙️) often represents Settings on the Home screen.

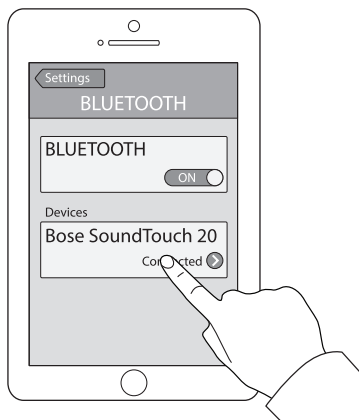

3. Select your SoundTouch™ system from the device list.

Once paired, your SoundTouch™ system's name appears connected in the device list.

4. On the *Bluetooth* enabled device, play music to stream to your system.

If you cannot pair your device

You may need to clear the system's *Bluetooth* pairing list (page 21). After you clear the list, try pairing again (page 19).

See "Troubleshooting" on page 25 for more information.

Connecting to a paired Bluetooth® enabled device

You can stream audio from a *Bluetooth*® enabled device to your system. There are two ways to stream audio from a paired device to your SoundTouch™ system.

If there are multiple devices stored in the system's pairing list, it may take a minute or two for the paired device to connect. Your system's display indicates connection status.

Using the | AUX button

1. On the system's button pad or remote control, press and release  | AUX until a *Bluetooth* connecting message appears on the display.

The system connects to the last device that streamed to your system.

2. On the device, play music.

Tip: If a paired device is connected, you do not need to press  | AUX.

If you cannot stream audio from a paired device

Your SoundTouch™ system may have lost connection to the device. Check the system's display. If the paired device is out of range of your system, move the device within range.

Using the *Bluetooth*® feature on the paired device

1. On the *Bluetooth* enabled device, turn on the *Bluetooth* feature.
2. Select your SoundTouch™ system from the device list.
3. Once connected, on the *Bluetooth* enabled device, play music to stream to your system.

Clearing the system's *Bluetooth*® pairing list

When you pair a *Bluetooth* enabled device to your system, the connection is stored in the system's pairing list. You may need to clear the pairing list if you cannot connect to a device. Once you clear the list, you need to pair previously-paired devices again.

On the button pad or remote control, press and hold  | AUX (about 10 seconds).

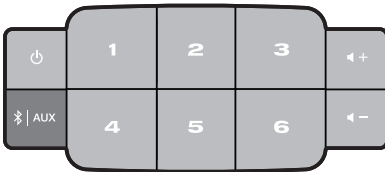

A message similar to *Pairing list cleared* appears on the display.

The system is ready to pair to a device (page 19).

Connecting a Device to the AUX IN Connector

Using a cable to connect an audio device

You can connect the audio output of a smartphone, tablet, computer or other type of audio device to your system's AUX IN connector. The AUX IN connector accepts a 3.5 mm stereo cable plug (not provided).

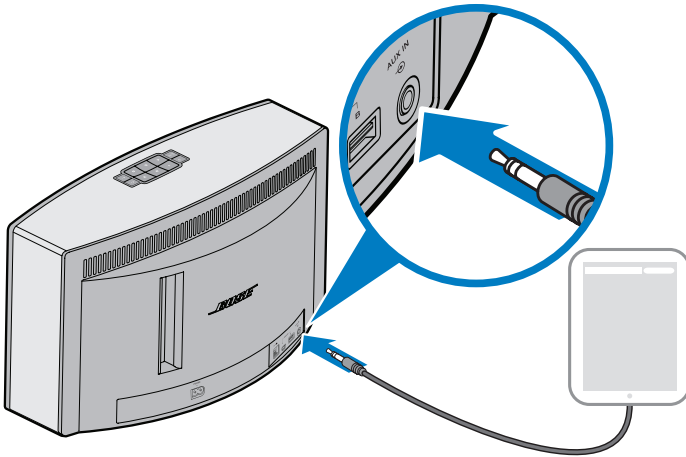

1. Using a stereo cable, connect your audio device to the **AUX IN** connector on the system.



2. On the system's button pad or remote control, press and release **⌘** | **AUX** until **AUX** appears on the display.
3. Start playing music on the audio device.

Updating system software

The app alerts you when a software update is available, at which time you can update the system within the app. However, you can also update system software using the button pad.

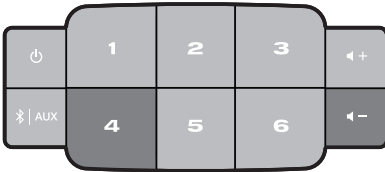

1. Press  to power the system on.
2. On the button pad, press and hold **4** and  (about 5 seconds).



The display shows a countdown from 5-1. A progress bar indicates status.
An update complete message appears on the display.

Disabling Wi-Fi® capability

The system has built-in Wi-Fi® capability that enables wireless connectivity.

1. Press  to power the system on.
2. On the button pad, press and hold **3** and  (about 5 seconds).

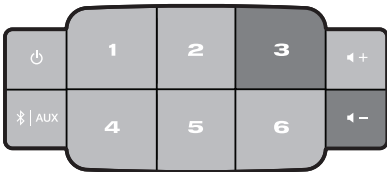

The display shows a countdown from 5 – 1 and a message similar to *Hold to disable networking* appears on the display.

The Wi-Fi indicator turns off when Wi-Fi is disabled.

Advanced Features

Re-enabling Wi-Fi® capability



While the system is on, press and hold **3** and  (about 5 seconds).

The display shows a countdown from 5 – 1 and a message similar to *Hold to enable networking* appears on the display.

The Wi-Fi® indicator illuminates when Wi-Fi is enabled.

Resetting the system

Factory reset clears all source, volume, and network settings from the system and returns it to original factory settings.

1. Press  to power the system on.
2. On the button pad, press and hold **1** and  (about 10 seconds).

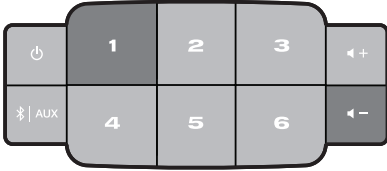

The display shows a countdown from 10 – 1 and a message similar to *Hold to restore factory settings* appears on the display.

The system restarts.

3. Launch the SoundTouch™ app on your computer and add the system to your network (see page 10).

Troubleshooting

For more troubleshooting information, refer to the in-app help.

Problem	What to do
Cannot complete network setup	<ul style="list-style-type: none"> • Connect the system to AC (mains) power. • Select correct network name and enter password. • Connect the device and SoundTouch™ system to the same Wi-Fi® network. • Place the wireless adapter within range of the router. • Enable Wi-Fi on the device (mobile or computer) you are using for setup. • If network name does not appear or is hidden, select Manually Connect to Another Network on the CONNECT TO HOME WI-FI NETWORK screen. • Close other open applications. • If using a computer for setup, check firewall settings to ensure that the SoundTouch™ app and SoundTouch™ Music Server are allowed programs. • Test your Internet connection by loading SoundTouch.com • Restart your mobile device, or computer, and router. • Uninstall the app, reset the system, and restart setup.
Cannot connect to network	<ul style="list-style-type: none"> • If your network information has changed or to connect your system to another network, refer to the in-app help. • Connect to the network using an Ethernet cable.
Intermittent or no audio	<ul style="list-style-type: none"> • Move system away from possible interference (microwaves, cordless phones, etc.). • Stop other audio or video streaming applications. • Move your mobile device closer to the speaker and away from any interference or obstructions. • Move system or audio device closer to wireless router or access point. • Ensure system volume is not muted or too low. • Unplug the power cord; reconnect after one minute.
Cannot play <i>Bluetooth</i> ® audio	<p>On your speaker:</p> <ul style="list-style-type: none"> • Pair a device (page 19). • Clear the speaker's pairing list (page 21). • Try pairing a different device. • Set up SoundTouch™ first, and perform all system updates. <p>On your mobile device:</p> <ul style="list-style-type: none"> • Disable and re-enable the <i>Bluetooth</i> feature. • Remove the speaker from the <i>Bluetooth</i> menu. Pair again. • Refer to your <i>Bluetooth</i> enabled device's documentation. • See Intermittent or no audio section.
Bass is too heavy or low	<ul style="list-style-type: none"> • Adjust the bass level of your system in the app. Refer to the in-app help.

Care and Maintenance

Getting diagnostic information

Get detailed information, such as MAC address and network information, serial number and software version.

1. On the button pad, press and hold **5** and  until system information appears on the display.

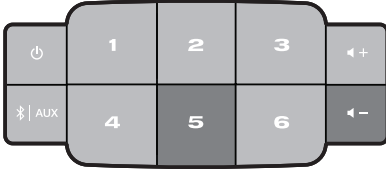

2. Press  or  to scroll through system information.

Cleaning

To clean your SoundTouch™ system, wipe the exterior using a soft, dry cloth. You can also lightly vacuum the grille on the system.

- DO NOT use solvents, chemicals, or sprays.
- DO NOT allow liquids to spill or objects to drop into any openings.

Replacing the remote control battery

WARNING: Keep new and used batteries away from children. Do not ingest battery, chemical burn hazard. The remote control supplied with this product contains a coin/button cell battery. If the coin/button cell battery is swallowed it can cause severe internal burns in just two hours and can lead to death. If the battery compartment does not close securely, stop using the product and keep it away from children. If you think the battery may have been swallowed or placed inside any part of the body, seek immediate medical attention. The coin/button cell battery may explode or cause a fire or chemical burn if incorrectly replaced or mis-handled. Do not recharge, disassemble, heat above 212°F (100°C), or incinerate. Replace only with an agency approved (ex. UL) CR2032 or DL2032 3-volt lithium battery. Dispose of used batteries promptly.

1. Use a coin to turn the battery cover slightly counterclockwise.

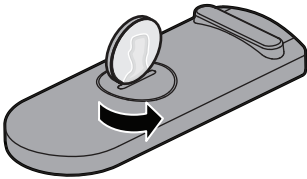

2. Remove the cover. Insert the new battery flat side up, with the + symbol in view.

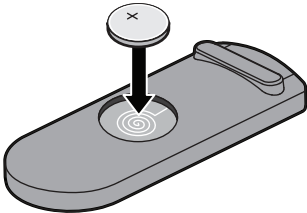

3. Reseat the cover and turn it clockwise to lock into place.

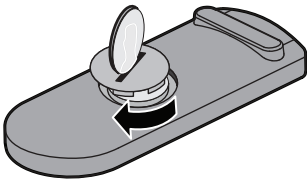

Care and Maintenance

Customer service

For additional help using the system:

- Visit SoundTouch.com
- Contact Bose® Customer Service. Refer to the quick start guide in the carton for contact information.

Limited warranty information

Your SoundTouch™ system is covered by a limited warranty. Details of the limited warranty are provided on the quick start guide in the carton. Please refer to the quick start guide for instructions on how to register. Failure to do so will not affect your limited warranty rights.

The warranty information provided with this product does not apply in Australia and New Zealand. See our website at www.bose.com.au/warranty or www.bose.co.nz/warranty for details of the Australia and New Zealand warranty.

SoundTouch™ 30 system

Size:	9.7"H x 17.1"W x 7.1"D (24.7 cm x 43.5 cm x 18.1 cm)
Weight:	18.5 lb (8.39 kg)
Input power rating:	U.S.A./Canada: 120V~ 50/60 Hz, 150W
	International: 220-240V~ 50/60 Hz, 150W
	Japan: 100V~ 50/60 Hz, 150W

SoundTouch™ 20 system

Size:	7.4"H x 12.4"W x 4.1"D (18.8 cm x 31.4 cm x 10.4 cm)
Weight:	7.0 lb (3.18 kg)
Input power rating:	USA/Canada/ International: 100-240V~ 50/60 Hz, 90W

Appendix: Using a Computer for Setup

Important setup information

- You can set up your system using a computer rather than a smartphone or tablet.
- Use a computer that is on your Wi-Fi® network.
- Use a computer where your music library is stored.
- You need the provided USB cable. *
- Do not connect the USB cable until the app instructs you to connect the cable.

* *The SETUP A USB connector on the back of the system is for computer setup only. The USB connectors are not designed to charge smartphones, tablets, or similar devices.*

Using a desktop computer for setup

If you are using a desktop computer, move the system near the computer to set up your system. During setup, the app prompts you to connect the USB cable from the computer to the system (temporarily).

After setup, disconnect the USB cable from your computer and from your system and move the system to its permanent location.

Setting up the system using a computer

1. Plug the power cord into an AC (mains) power outlet.
2. On your computer, open a browser and go to

SoundTouch.com/app

Tip: Use the computer where your music library is stored.

3. Download and run the SoundTouch™ app.

The app guides you through setup.



747473-0010

BOSE[®]
Better sound through research[®]

©2015 Bose Corporation, The Mountain,
Framingham, MA 01701-9168 USA
AM7747473 Rev. 00