

XXXXXXXXXXXX serie: xxx
.....
.....
Hergestellt für:
.....
.....

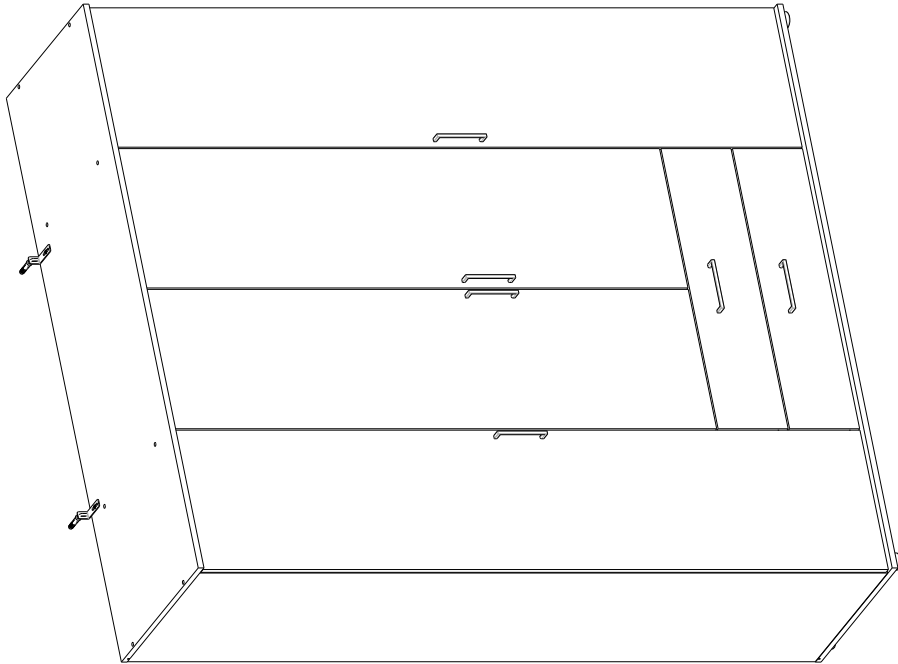

180 min

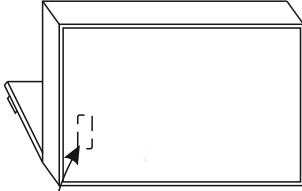
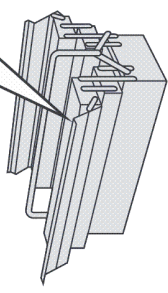
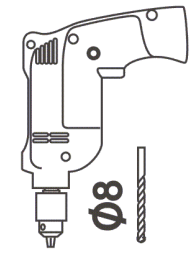
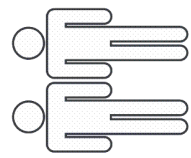
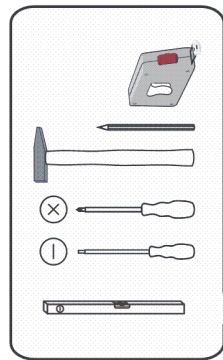
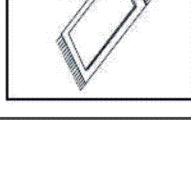
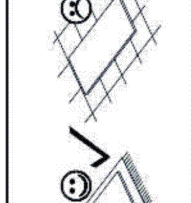
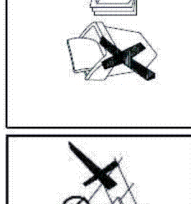
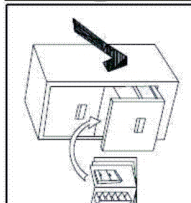
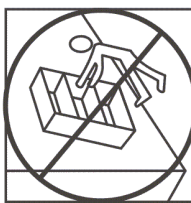
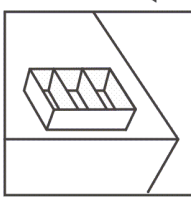
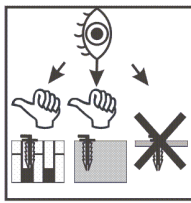
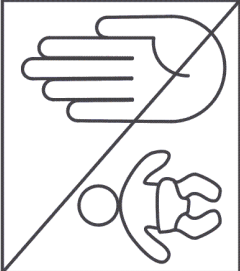
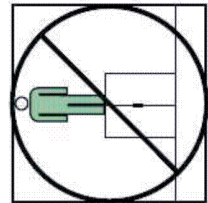
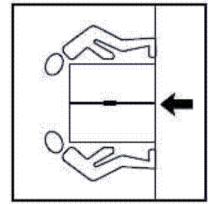
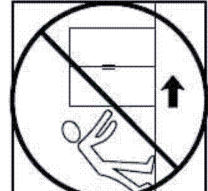
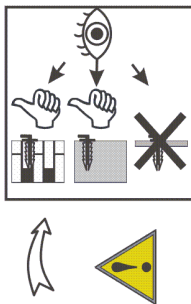
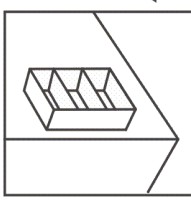
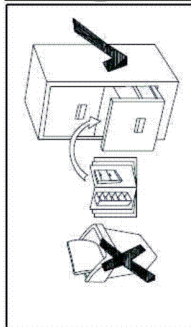
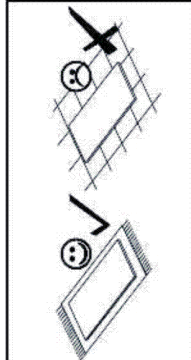

D



OPTION 'A'

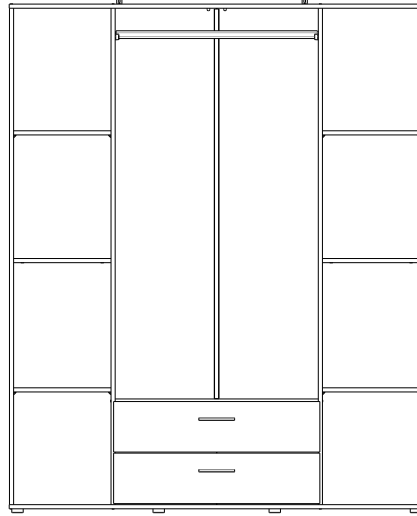

OPTION 'B'

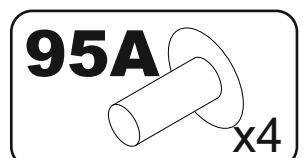
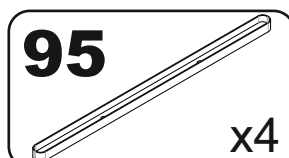
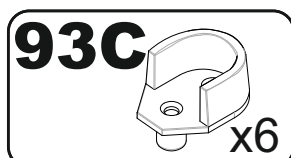
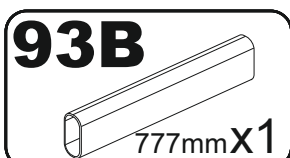
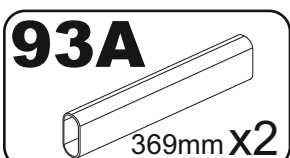
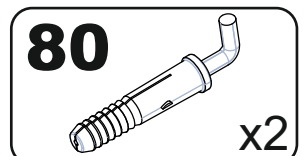
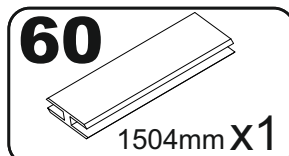
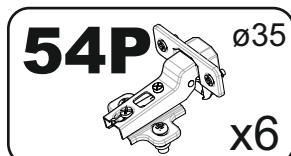
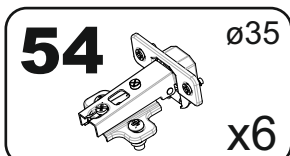
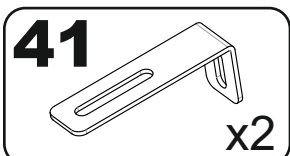
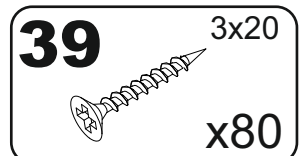
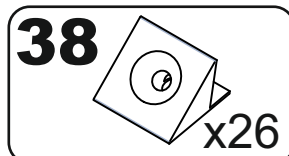
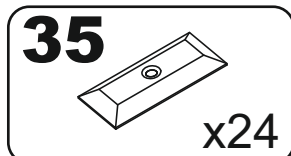
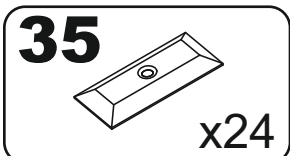
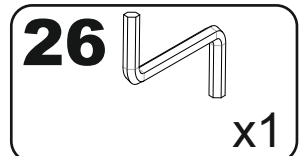
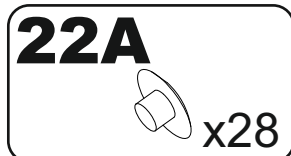
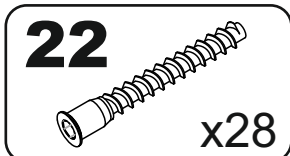
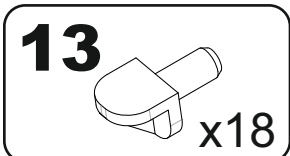
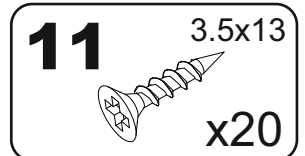
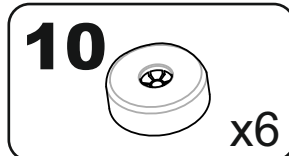
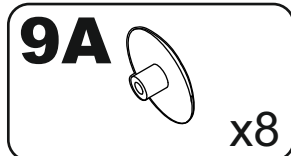
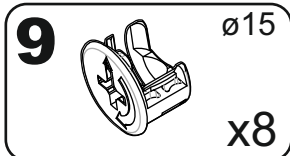
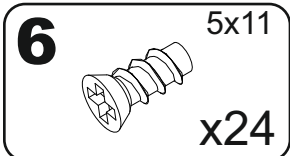
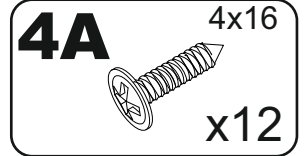
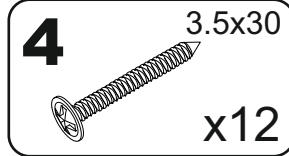
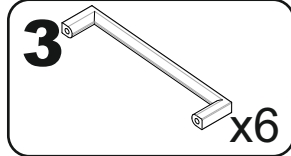
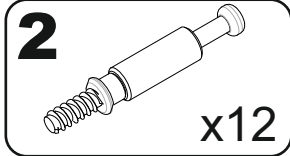
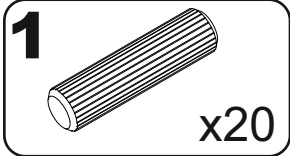
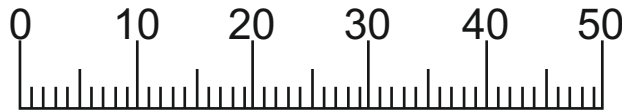
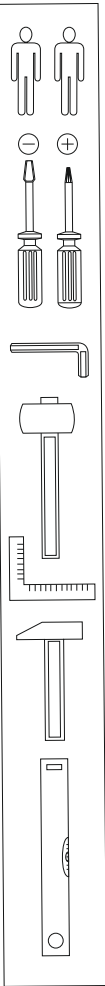
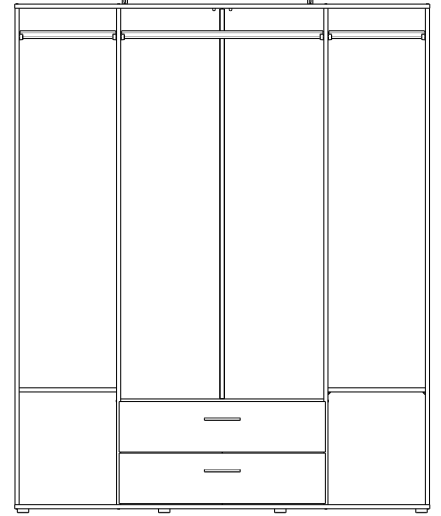

OPTION 'A'

D

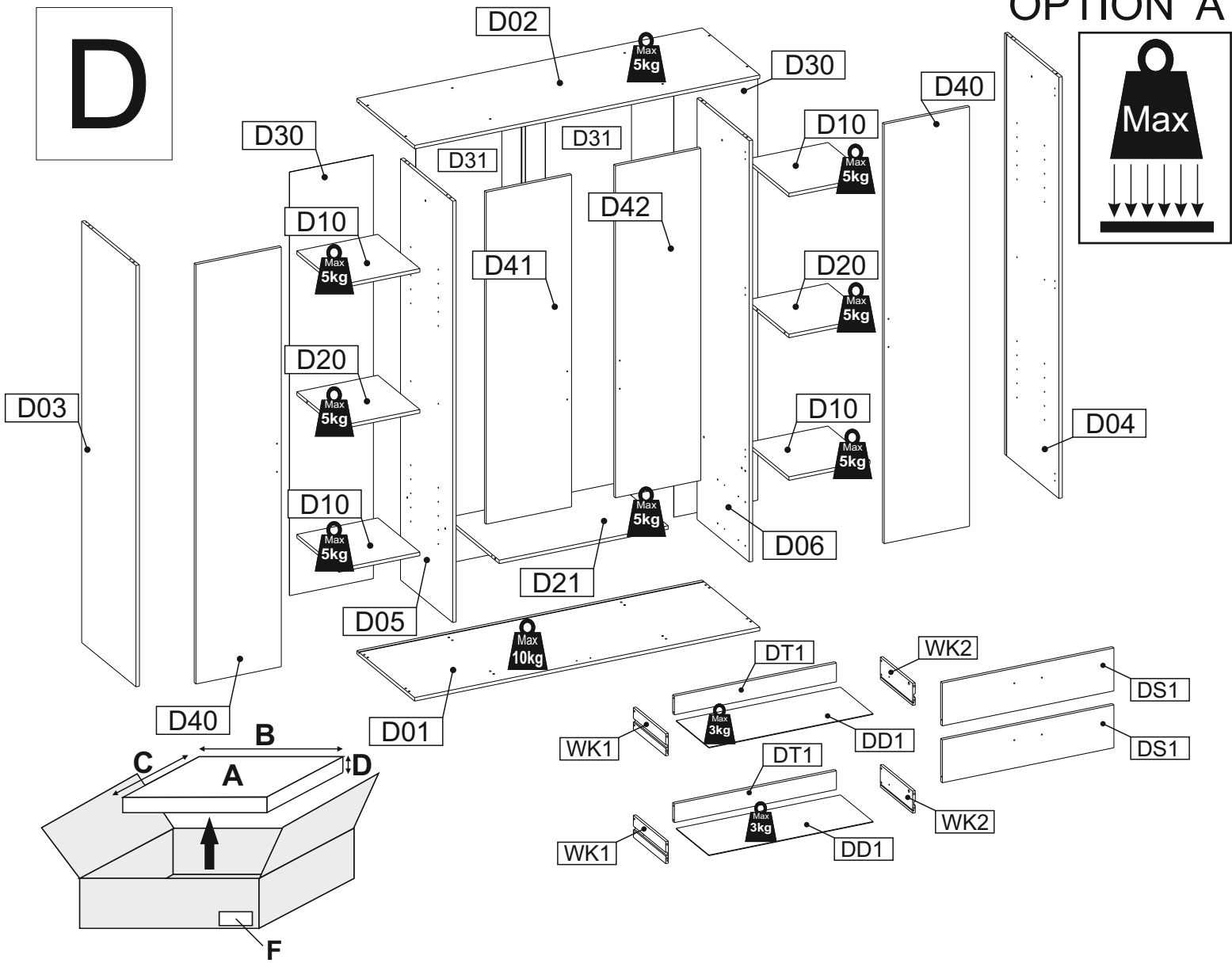

A	B (mm)	C (mm)	D (mm)	E	F
D01	1602	535	16	1	x/x
D02	1602	535	16	1	x/x
D03	1916	504	16	1	x/x
D04	1916	504	16	1	x/x
D05	1916	484	16	1	x/x
D06	1916	484	16	1	x/x
D10	376	390	16	4	x/x
D20	376	390	16	2	x/x
D21	784	484	16	1	x/x
D30	1926	389	3	2	x/x
D31	1926	399	3	2	x/x
D40	1908	396	16	2	x/x
D41	1510	396	16	1	x/x
D42	1510	396	16	1	x/x
DD1	762	303	3	2	x/x
DS1	796	195	16	2	x/x
DT1	752	85	16	2	x/x
WK1	300	100	12	2	x/x
WK2	300	100	12	2	x/x

1 OPTION 'B'

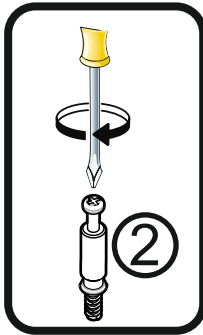
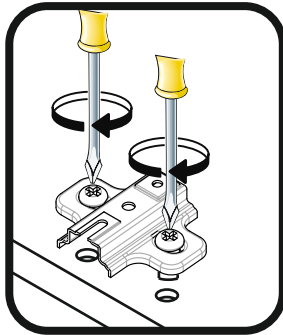
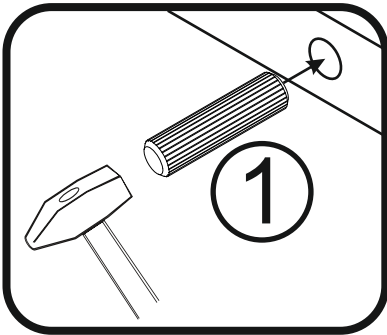
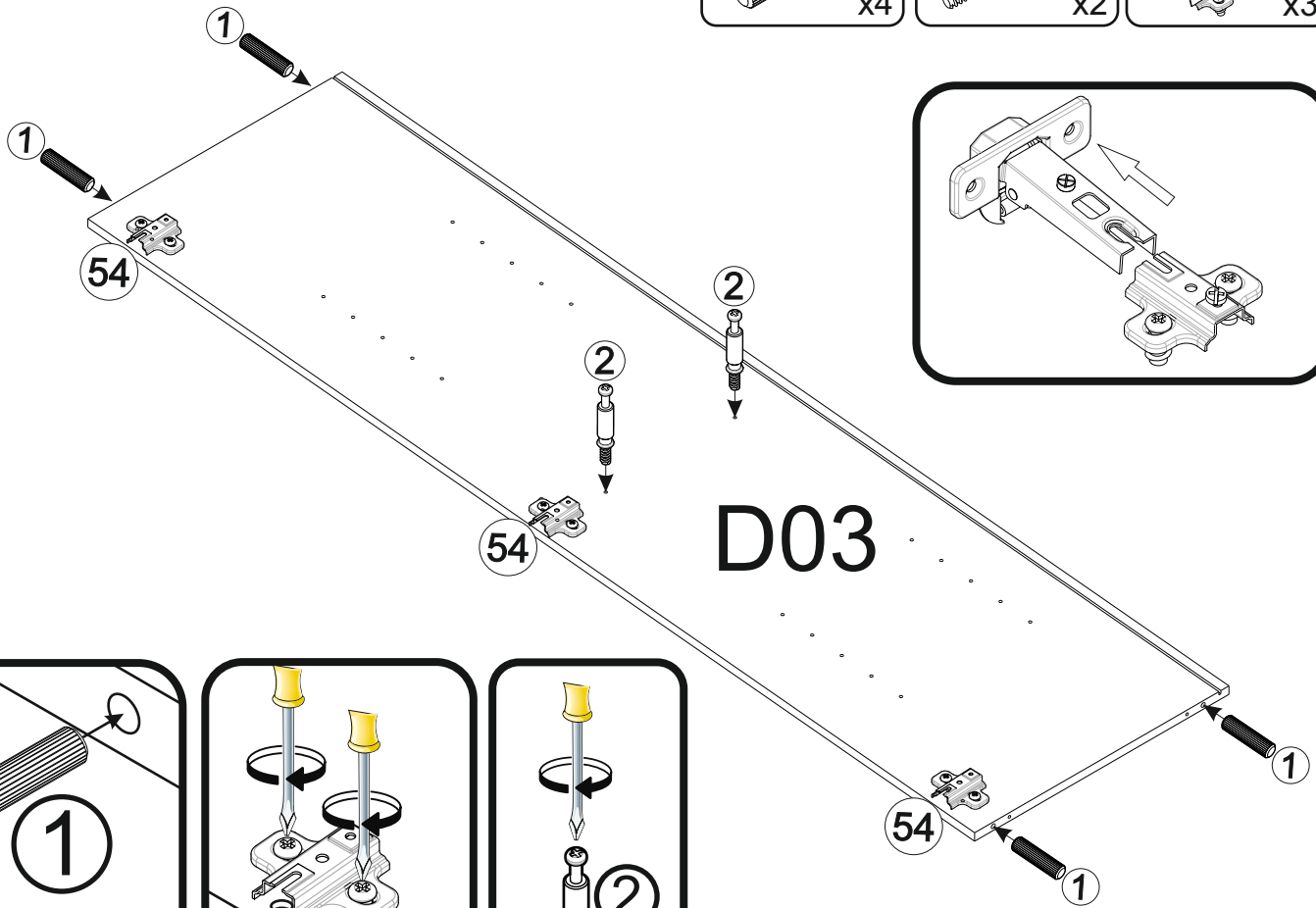
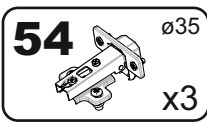
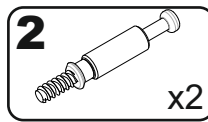
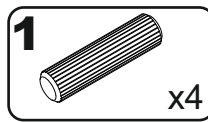

2

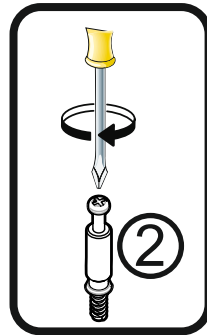
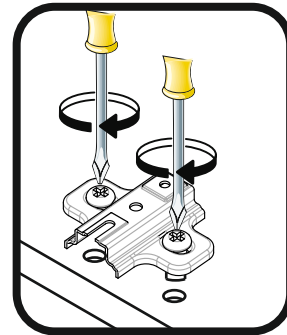
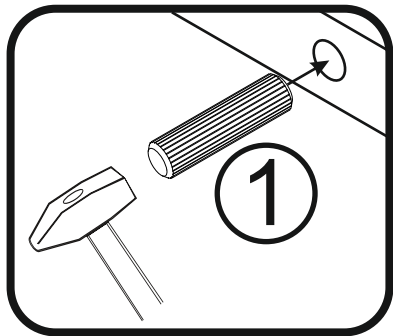
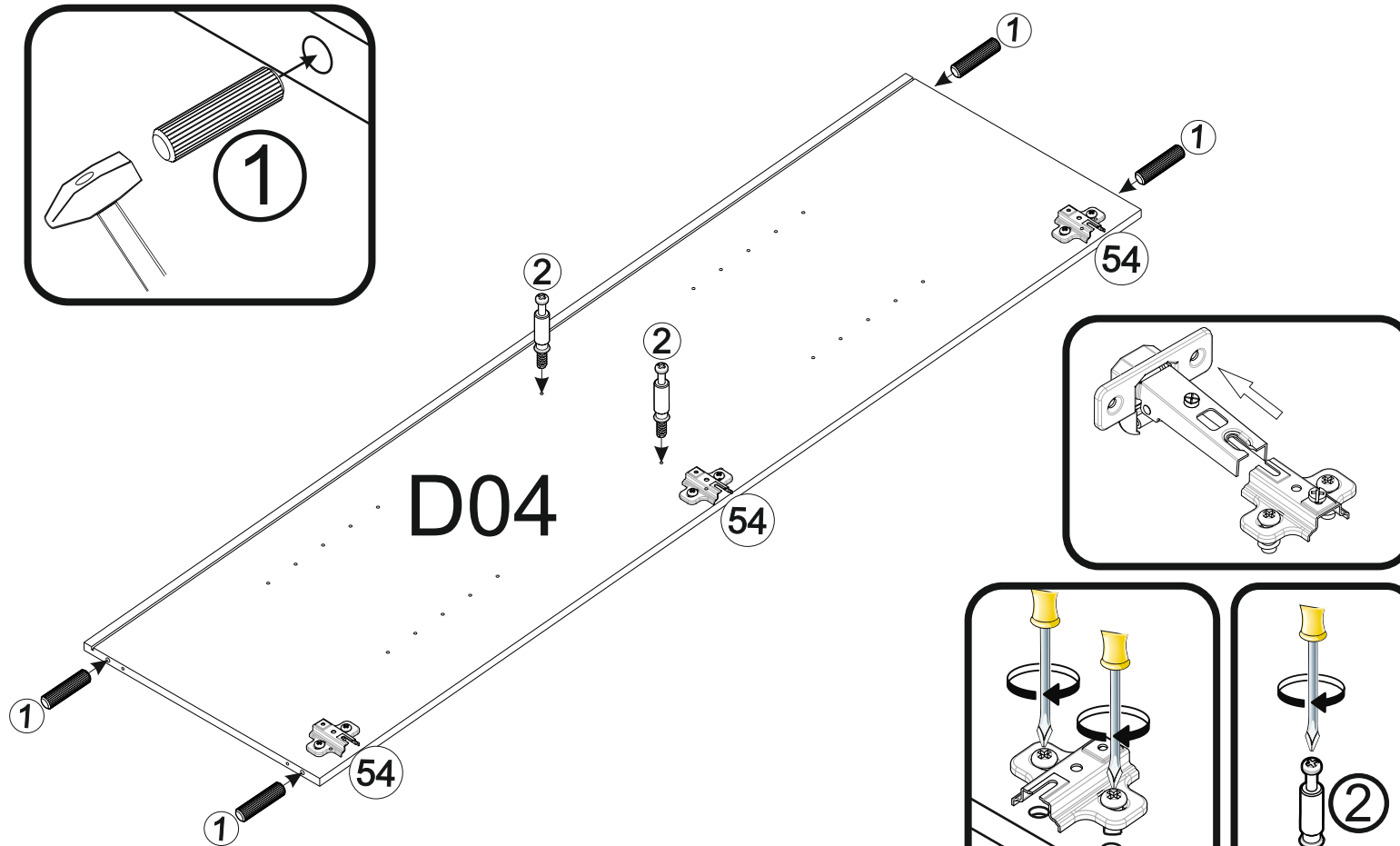
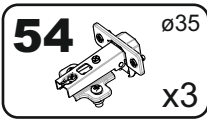
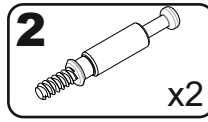
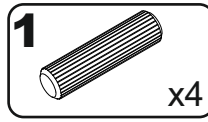





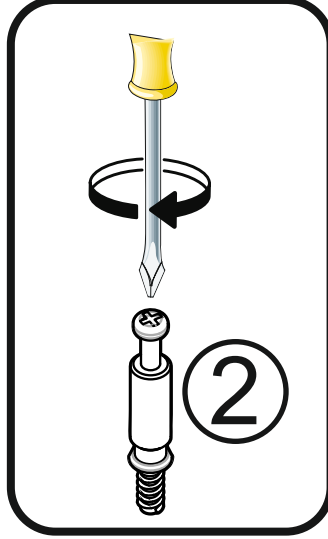
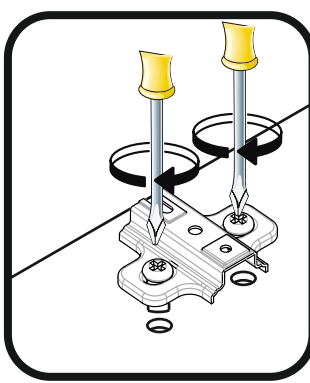
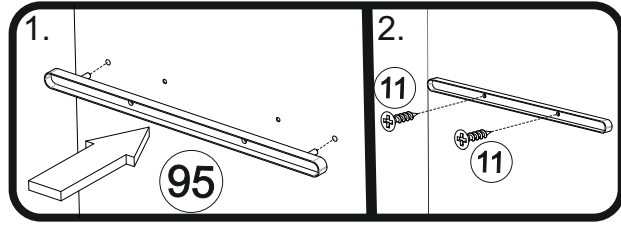
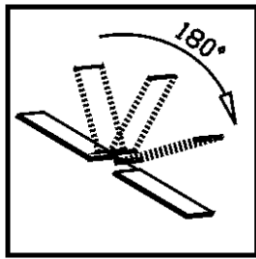
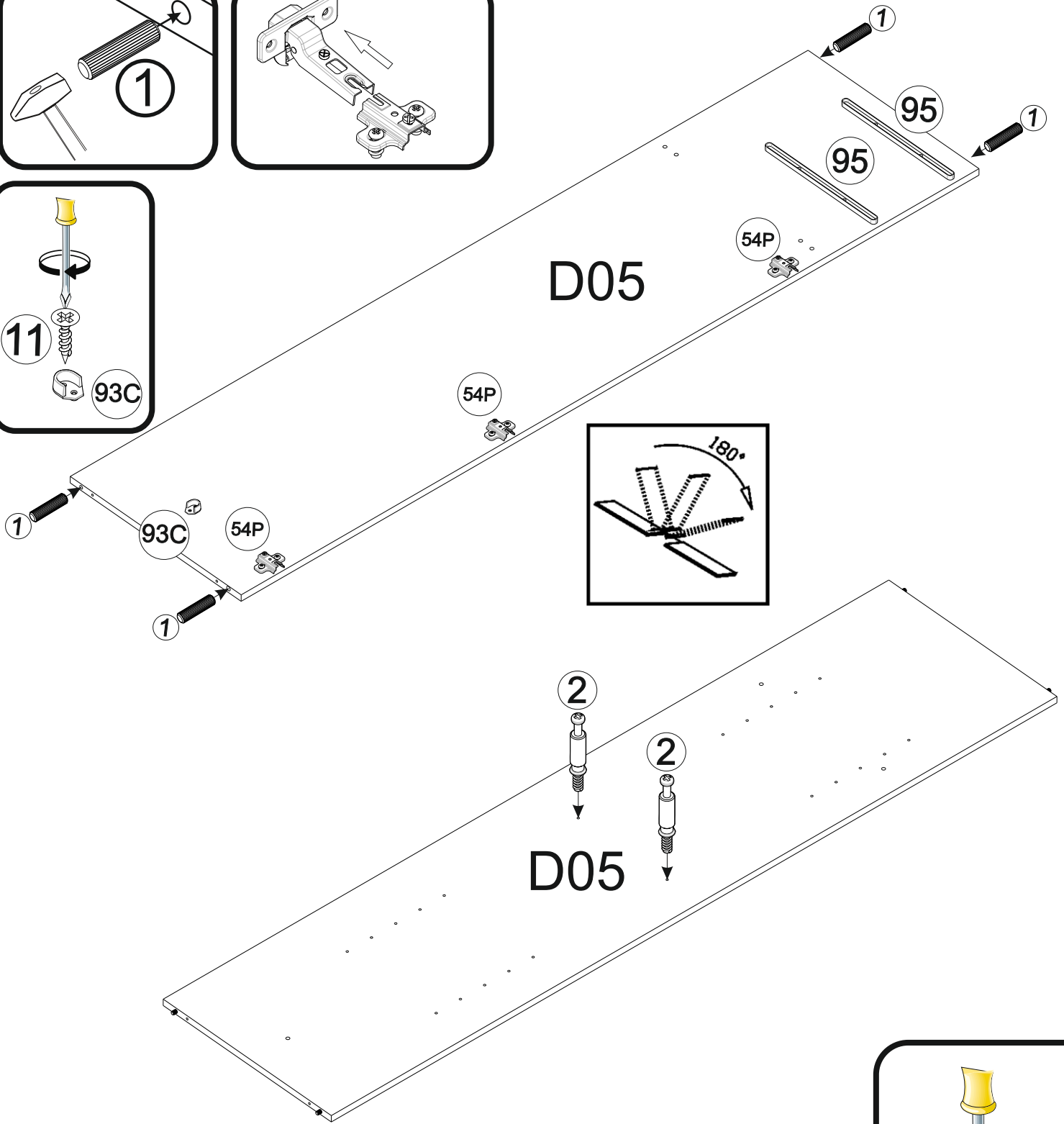
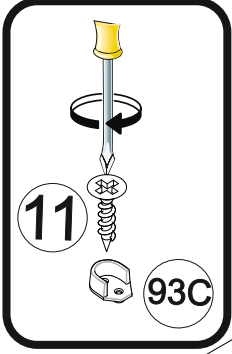
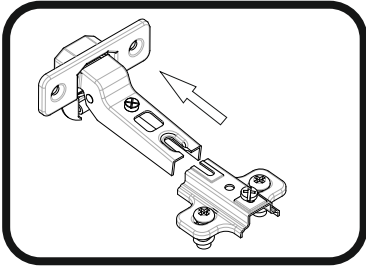
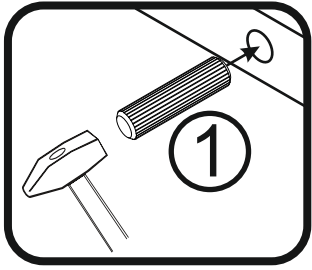
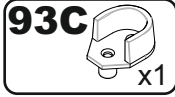
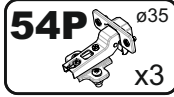
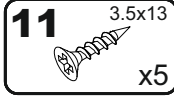
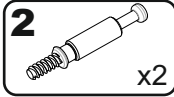
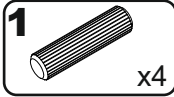

3

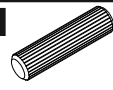
OPTION 'A'

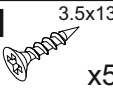

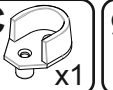
4 OPTION 'A'

- 1**  x4
- 2**  x2
- 11**  3.5x13 x5
- 54P**  $\varnothing 35$ x3
- 93C**  x1
- 95**  x2

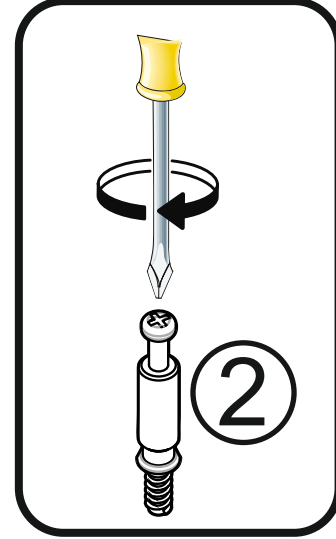
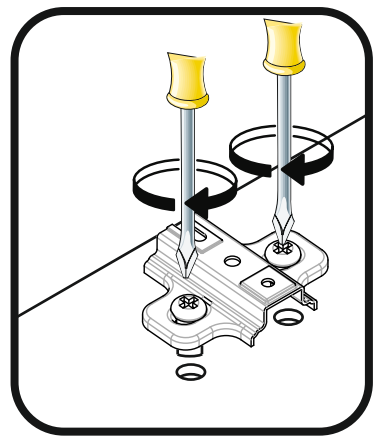
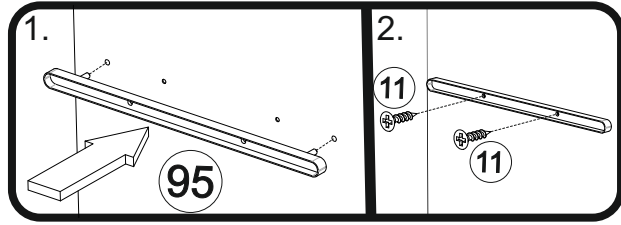
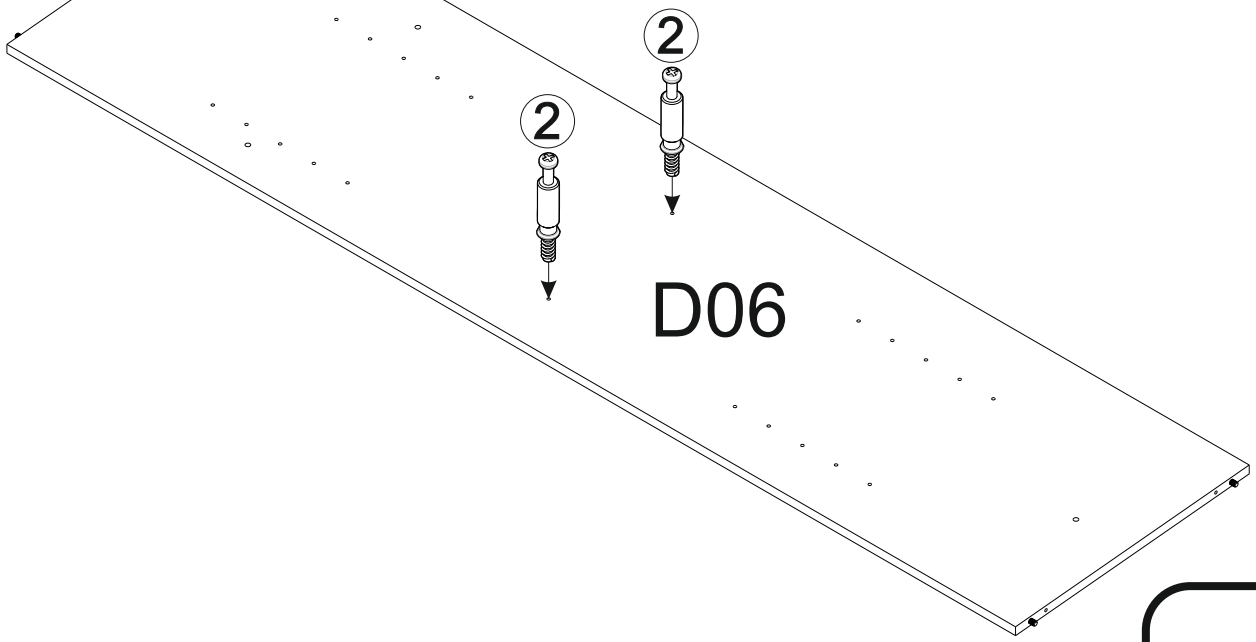
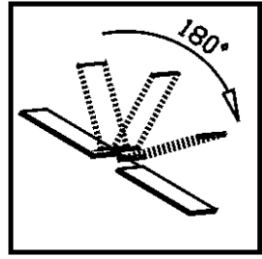
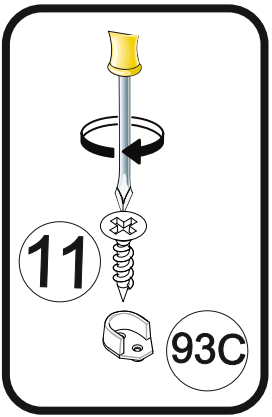
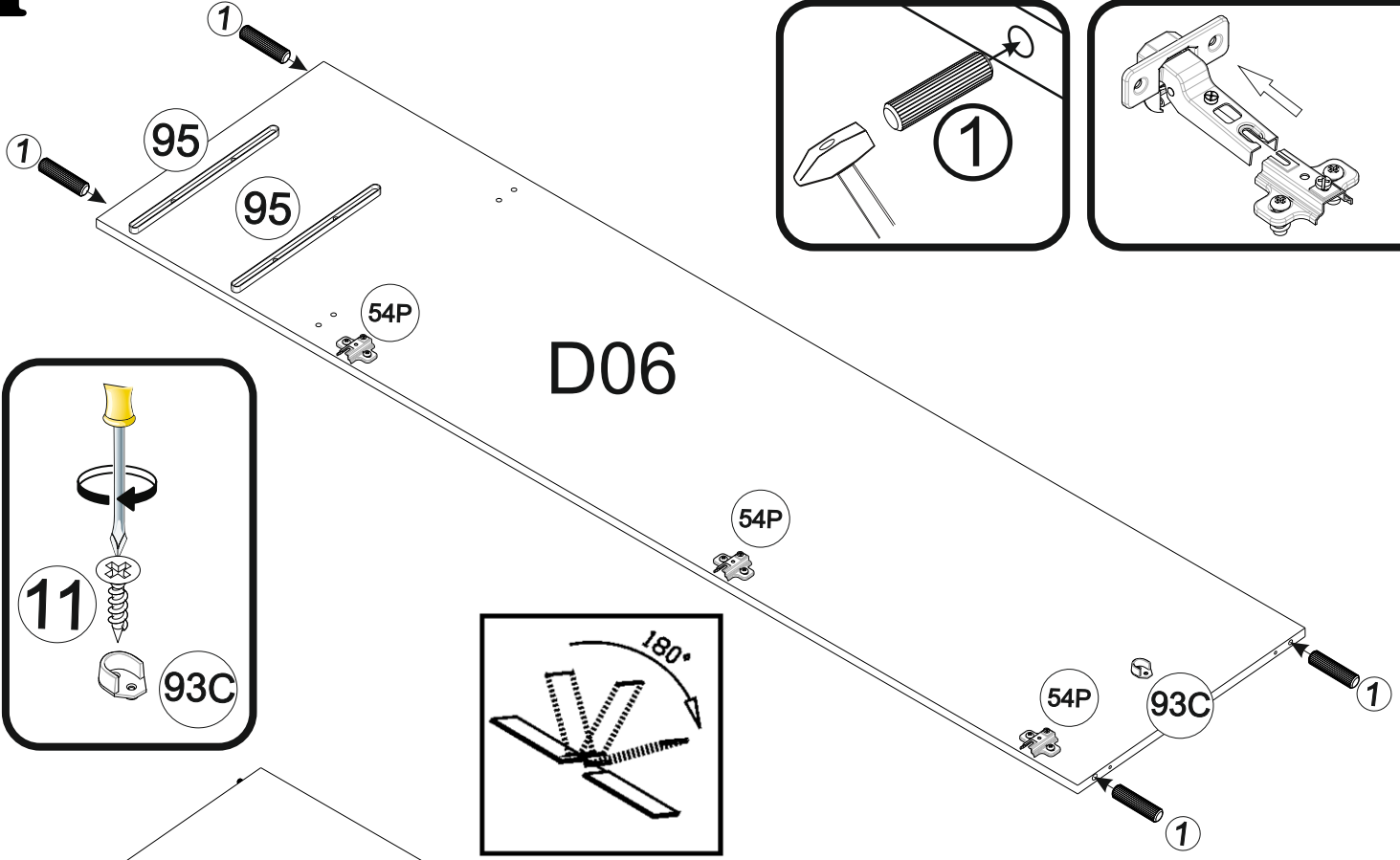

5 OPTION 'A'

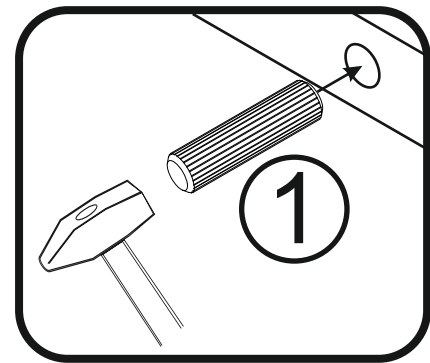
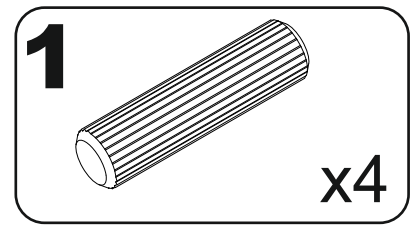
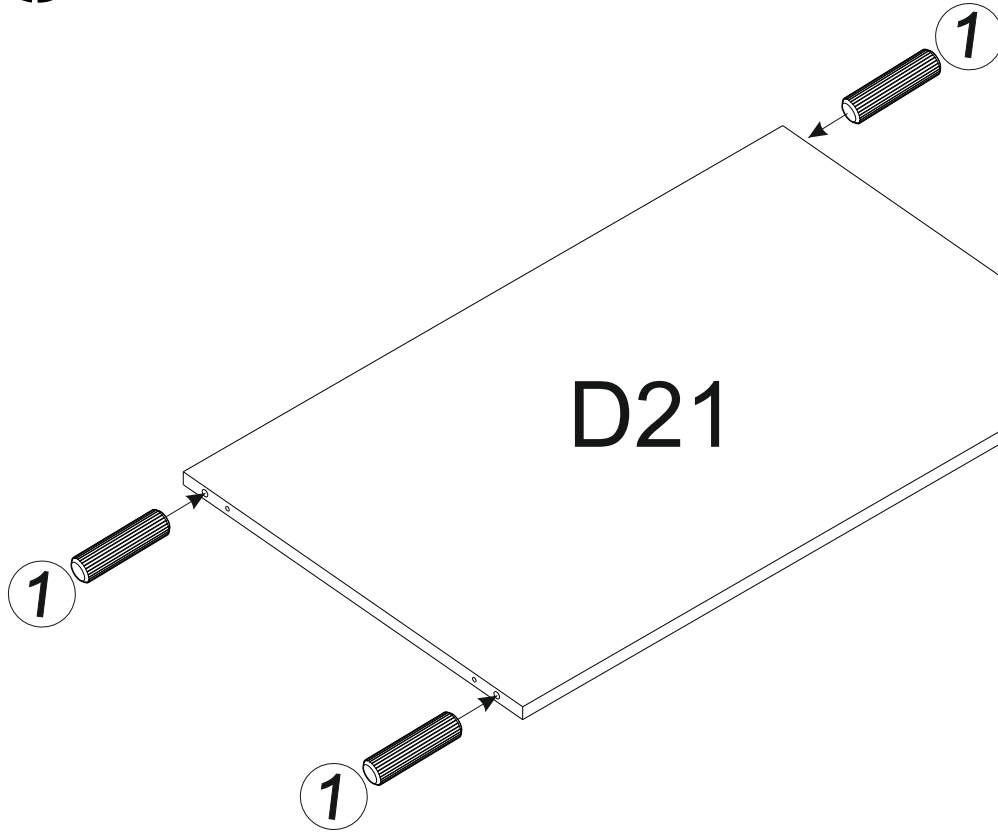

6

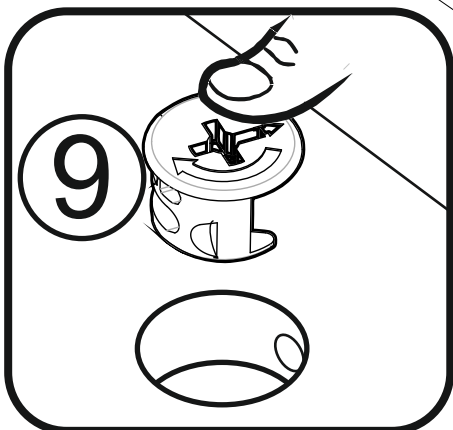
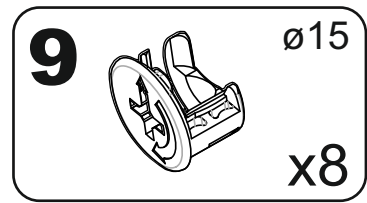
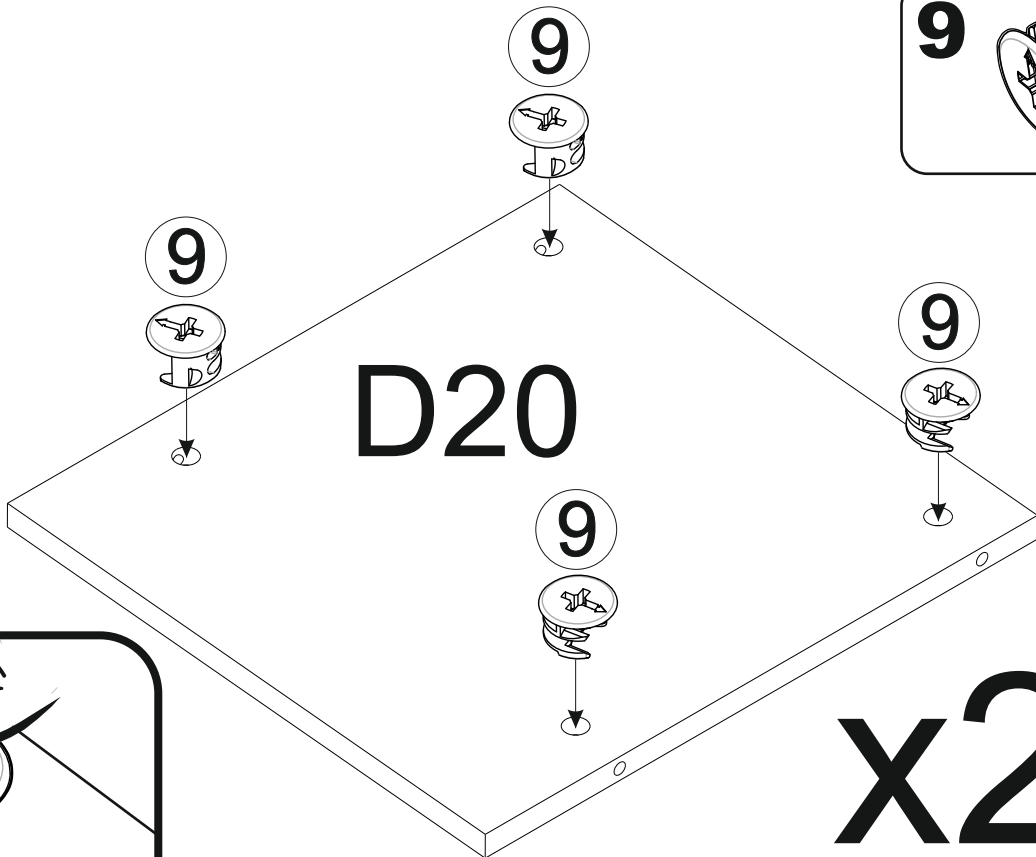

7 OPTION 'A'

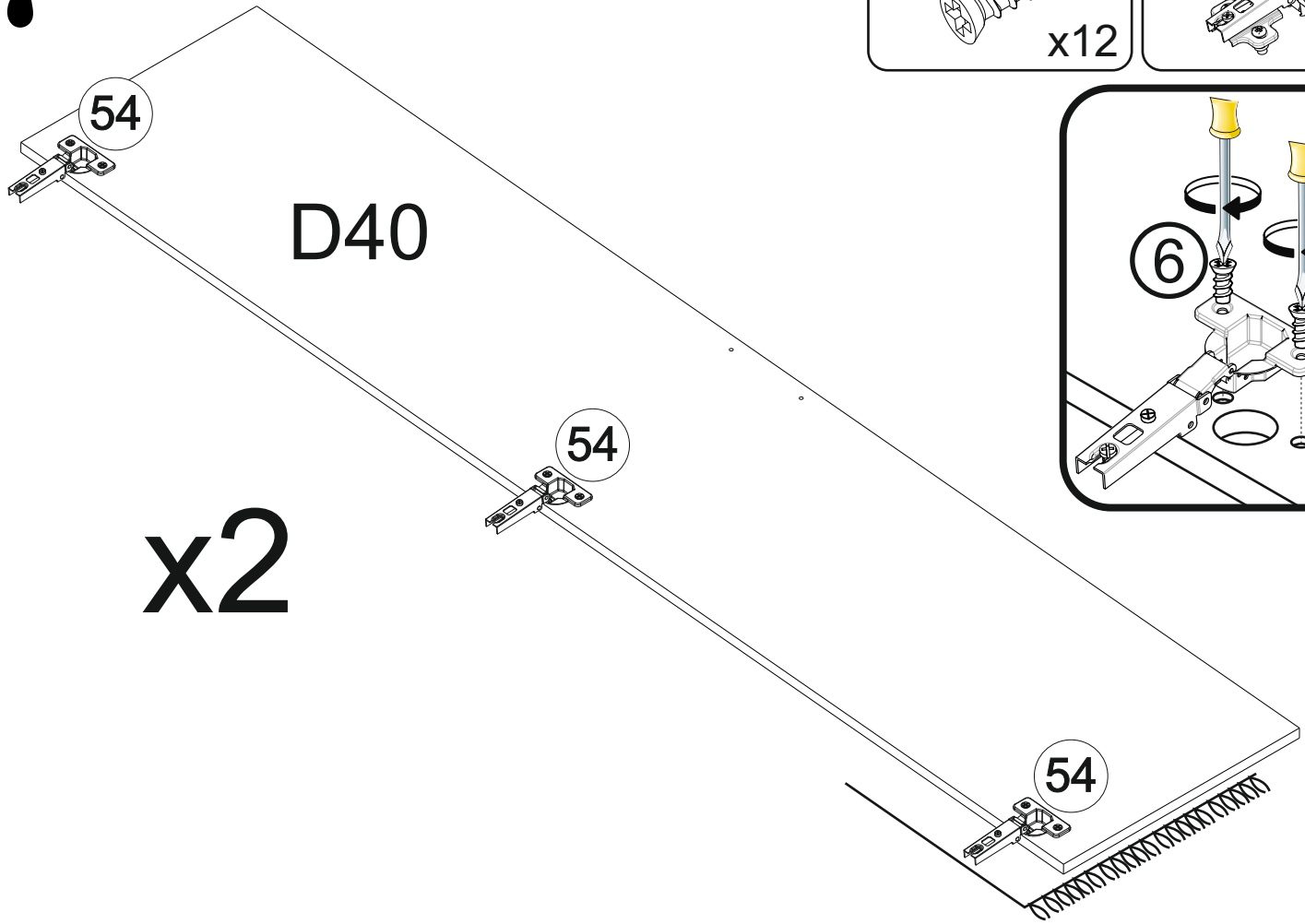

6 5x11
x12

54 ø35
x6

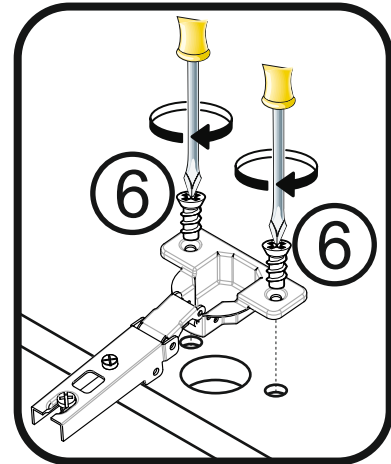

8

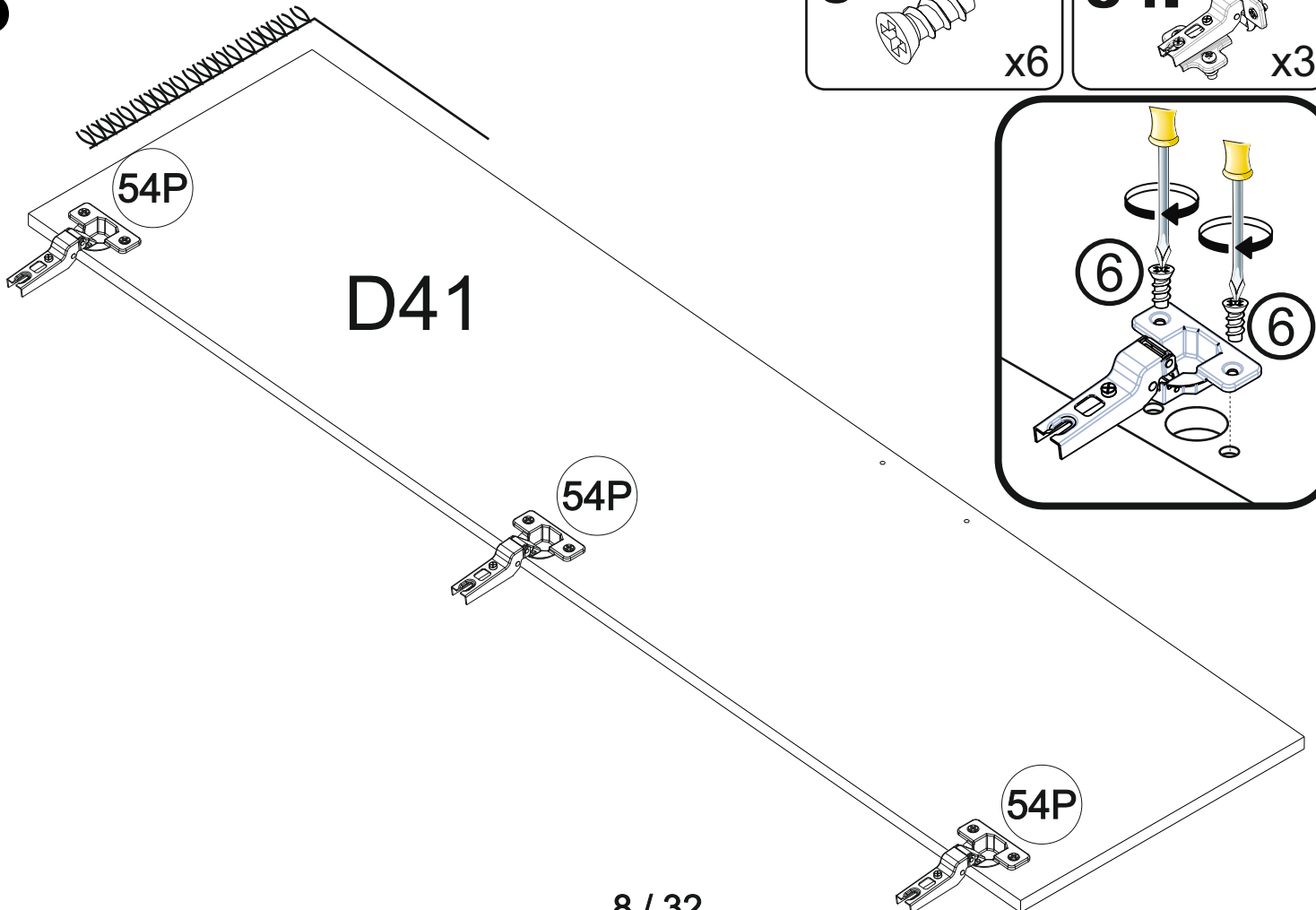

6 5x11
x6

54P ø35
x3

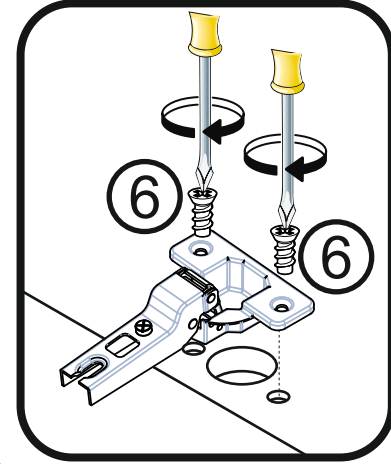

9 OPTION 'A'

6 5x11 x6

54P ø35 x3

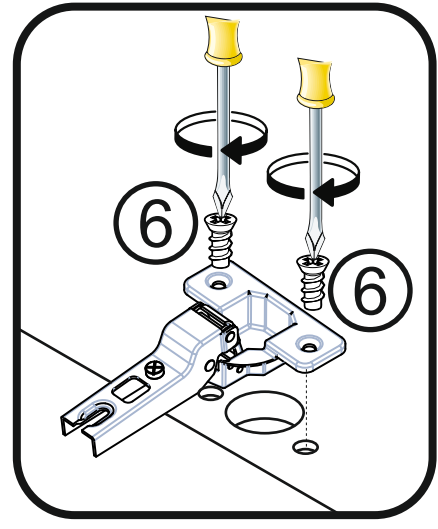
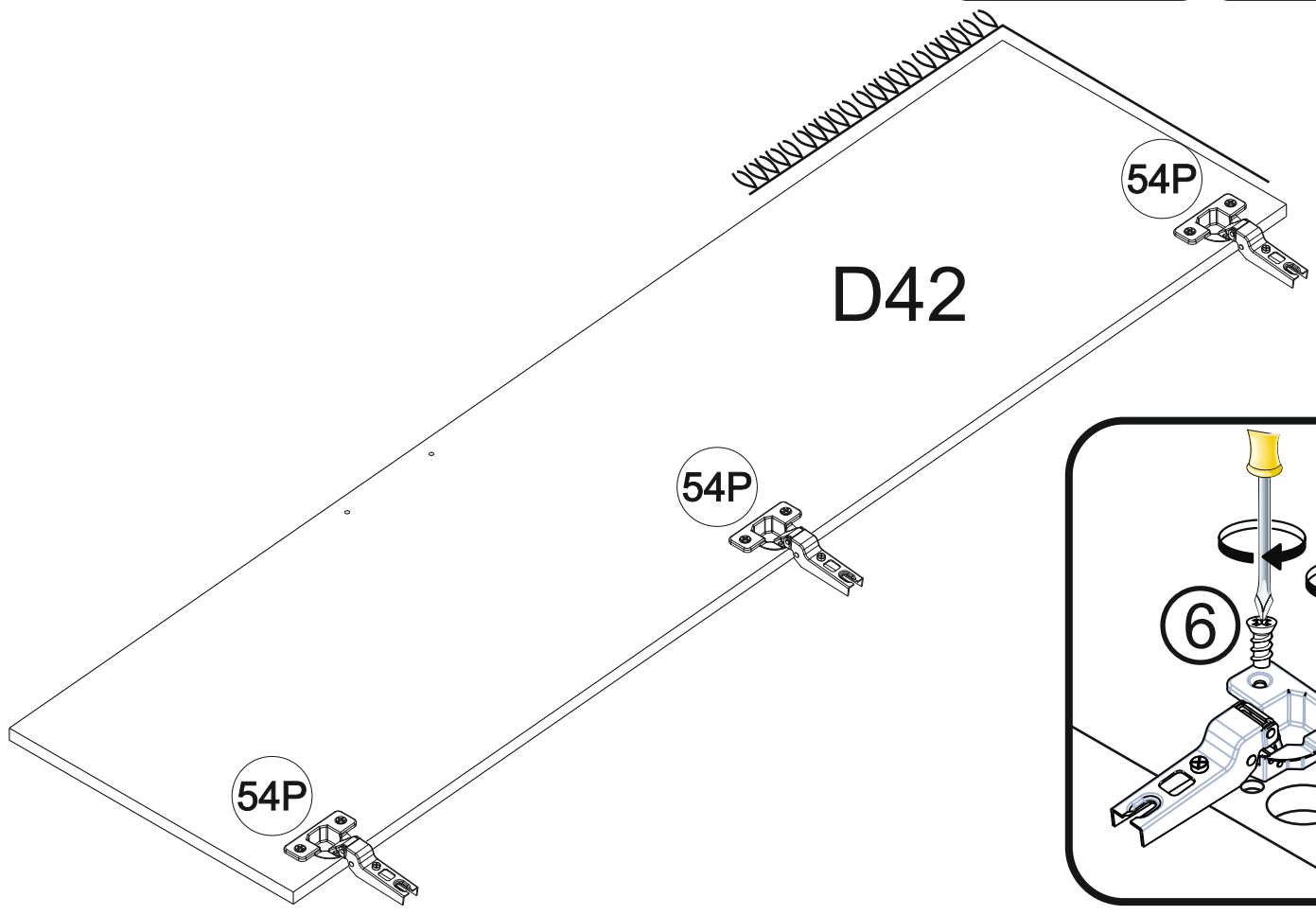
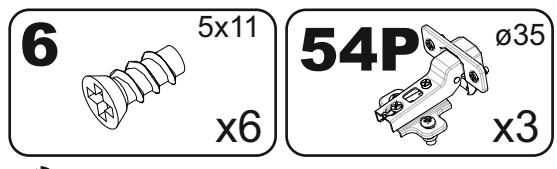

10

2 x4

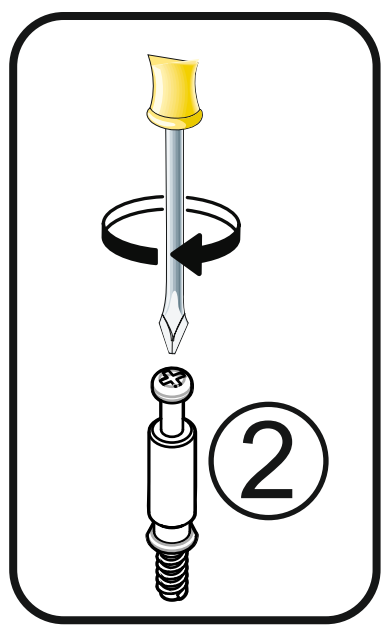
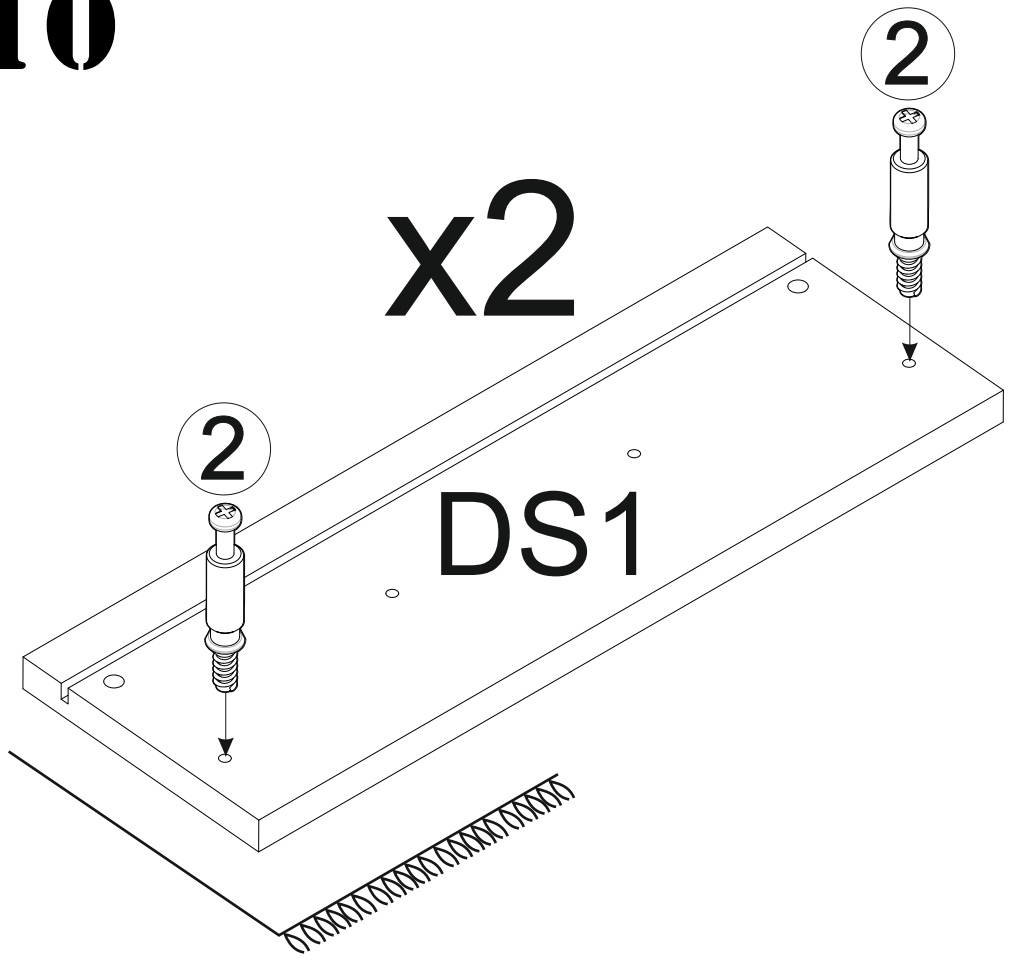
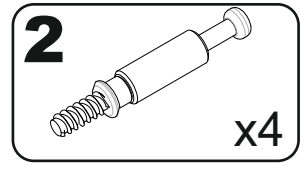

11 OPTION 'A'

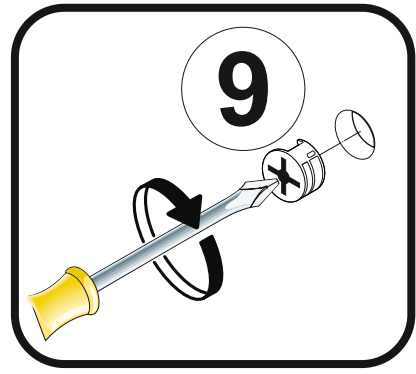
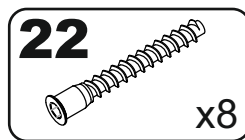
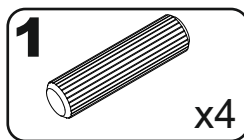

DT1

22

22

WK2 x2

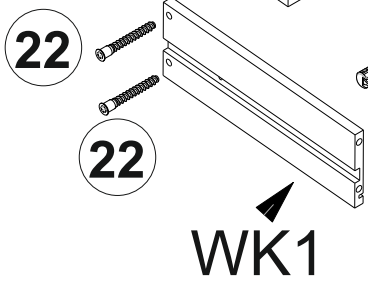

WK1

9

DS1

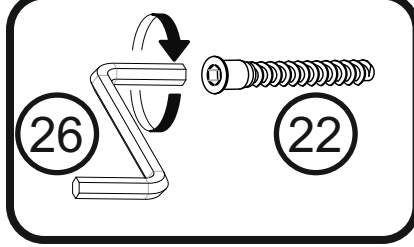
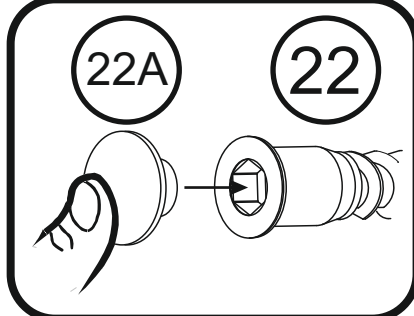

12

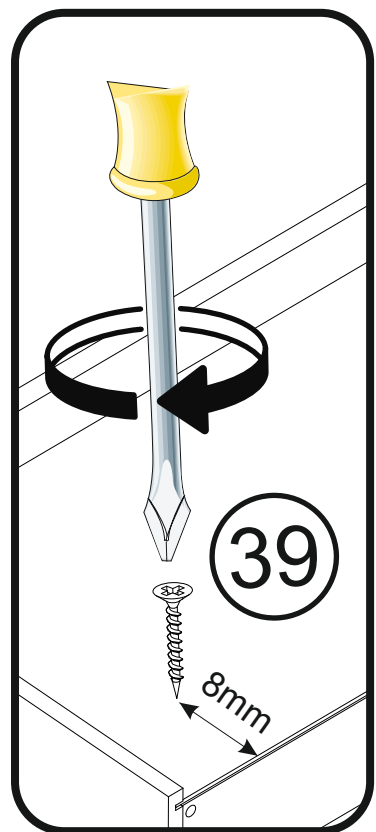
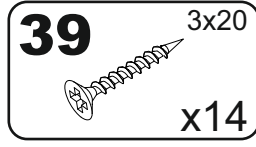

39

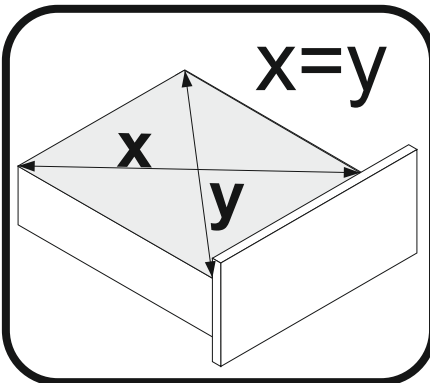

x=y

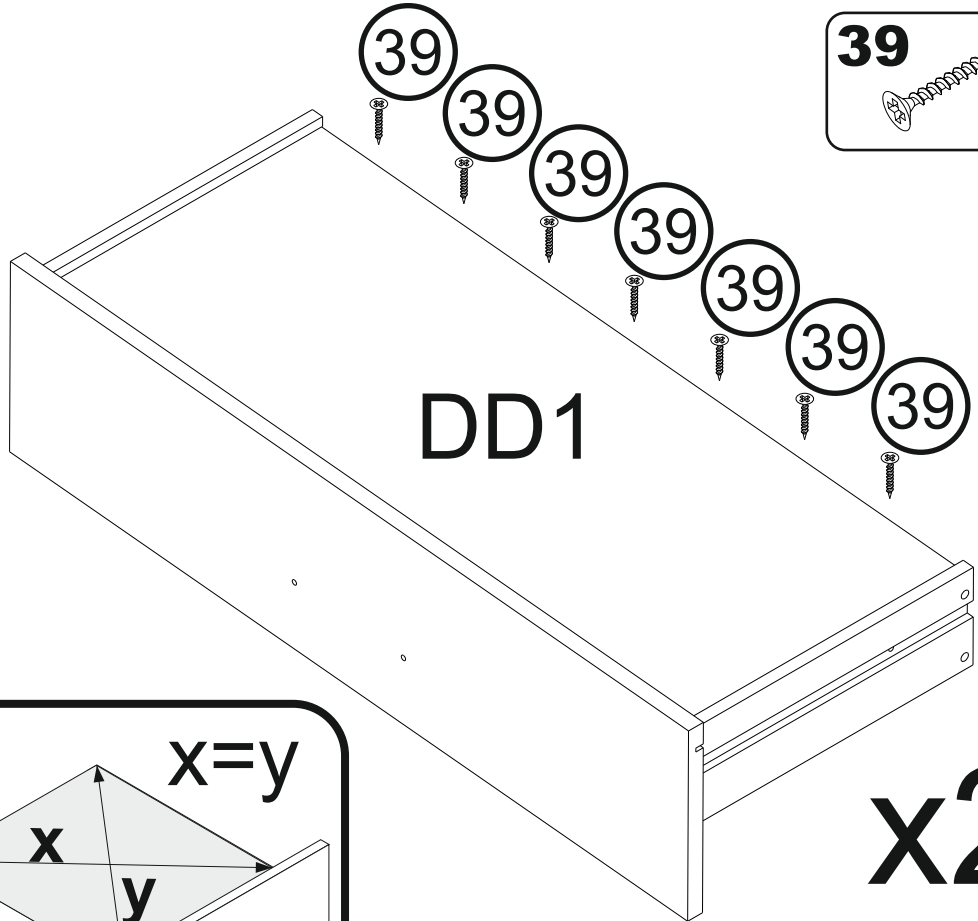

DD1

x2

13 OPTION 'A'

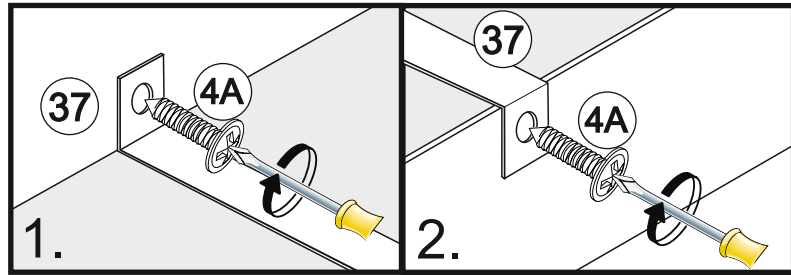
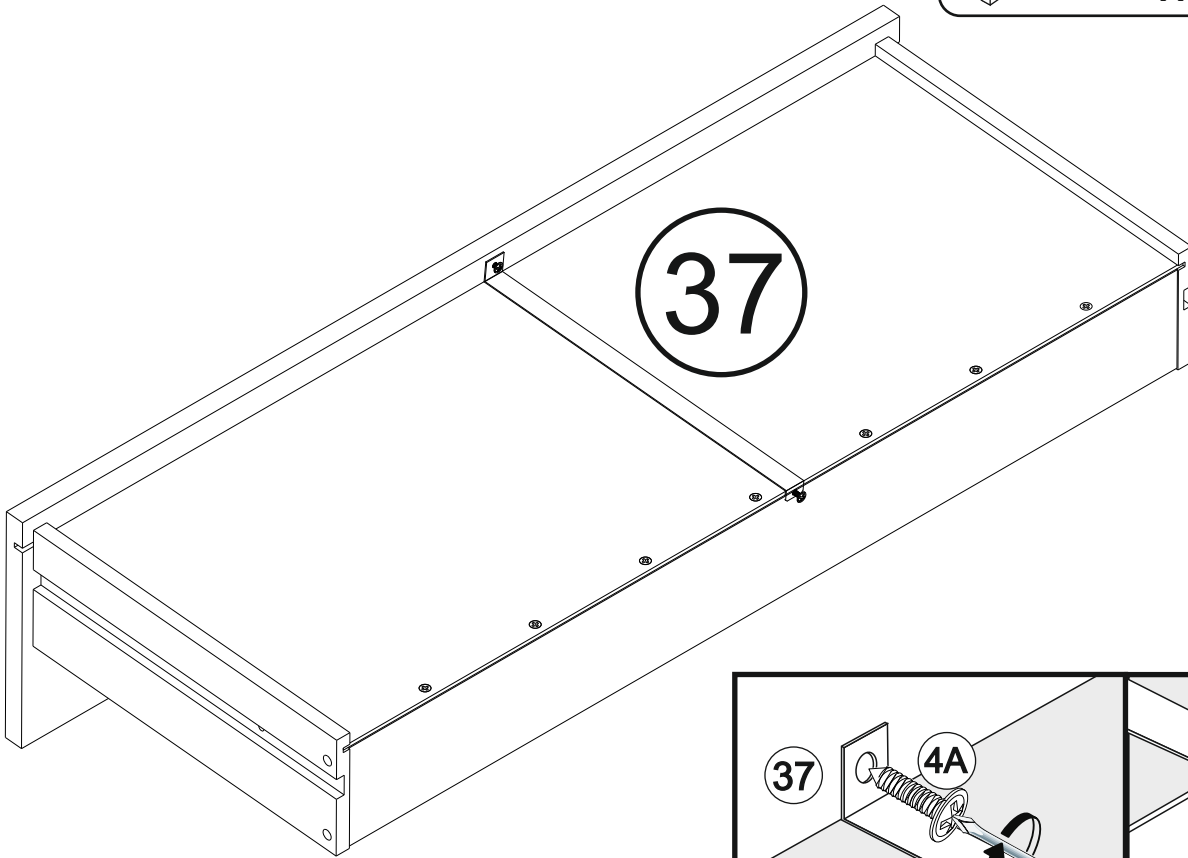
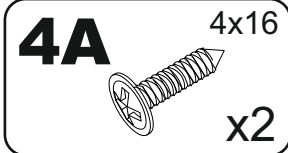
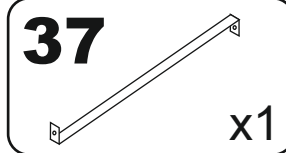

14

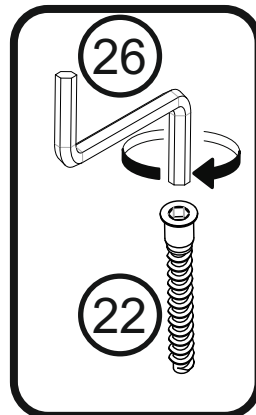
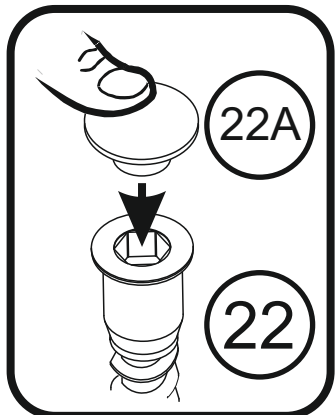
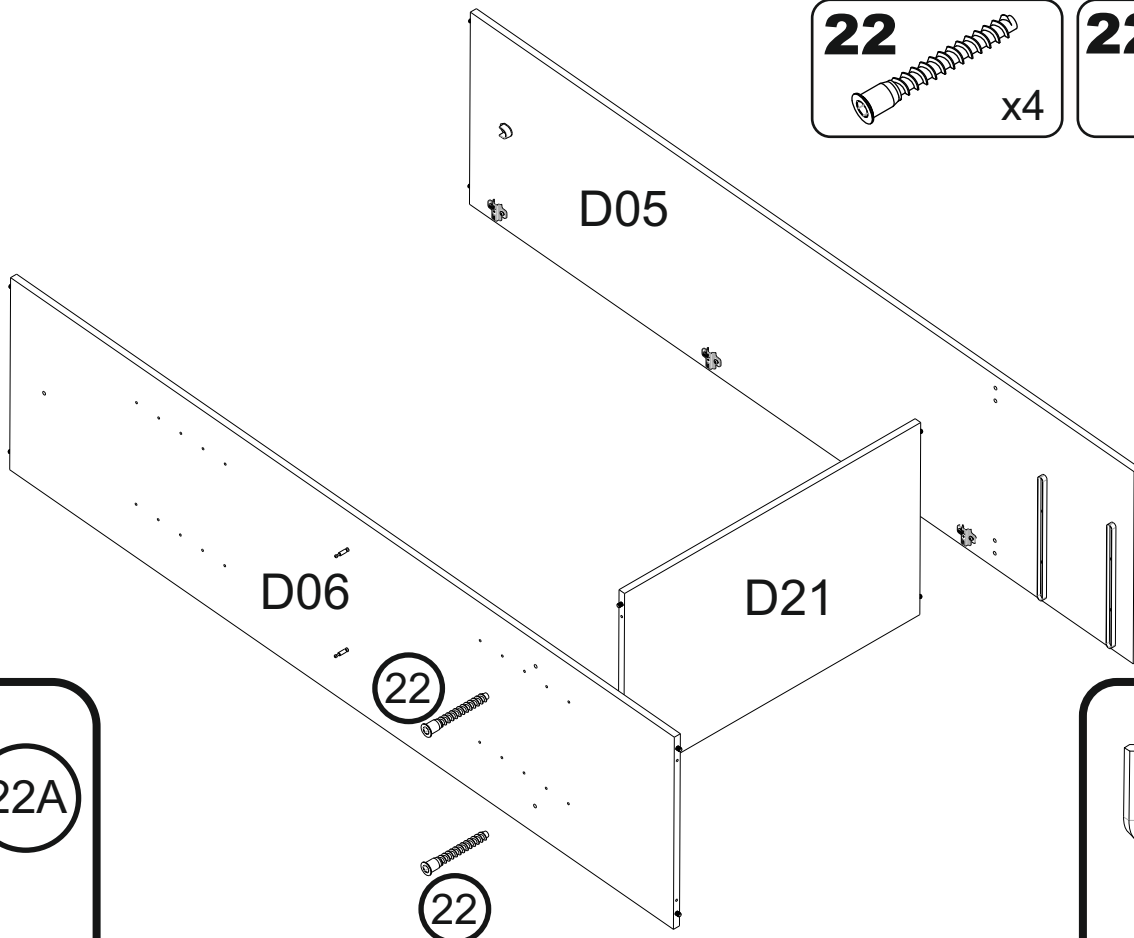
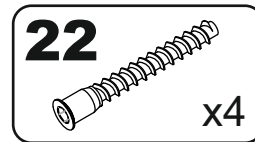

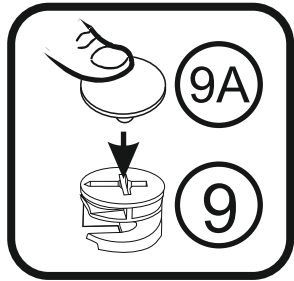
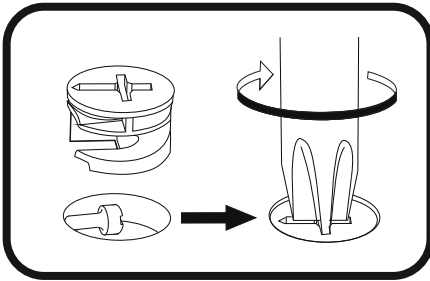
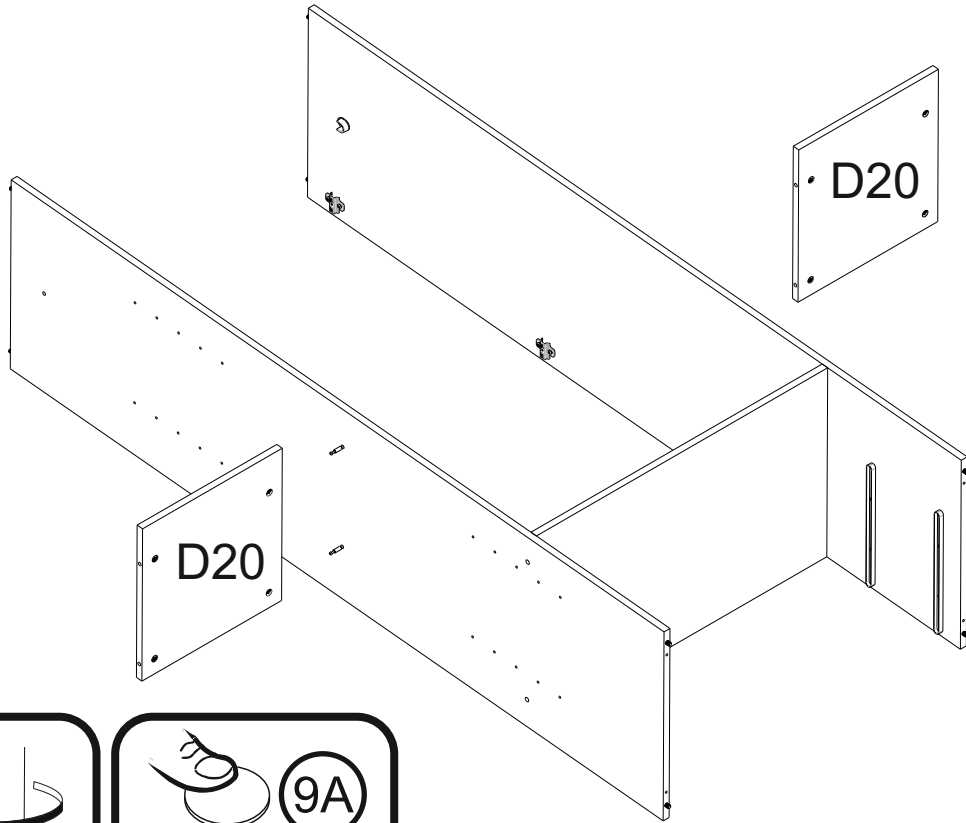

15 OPTION 'A'

9A  x4



16

9A  x4

22  x8

22A  x8

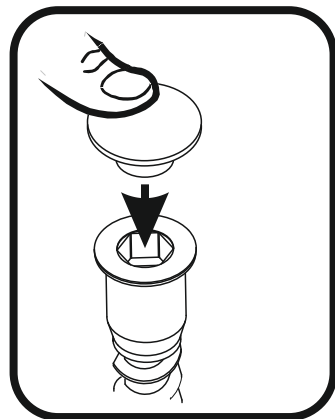
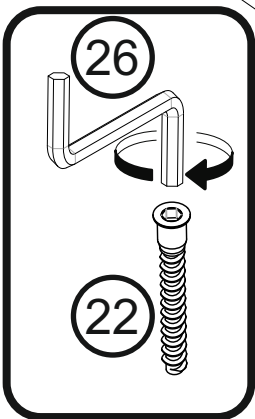
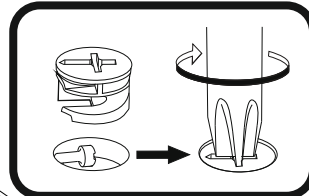
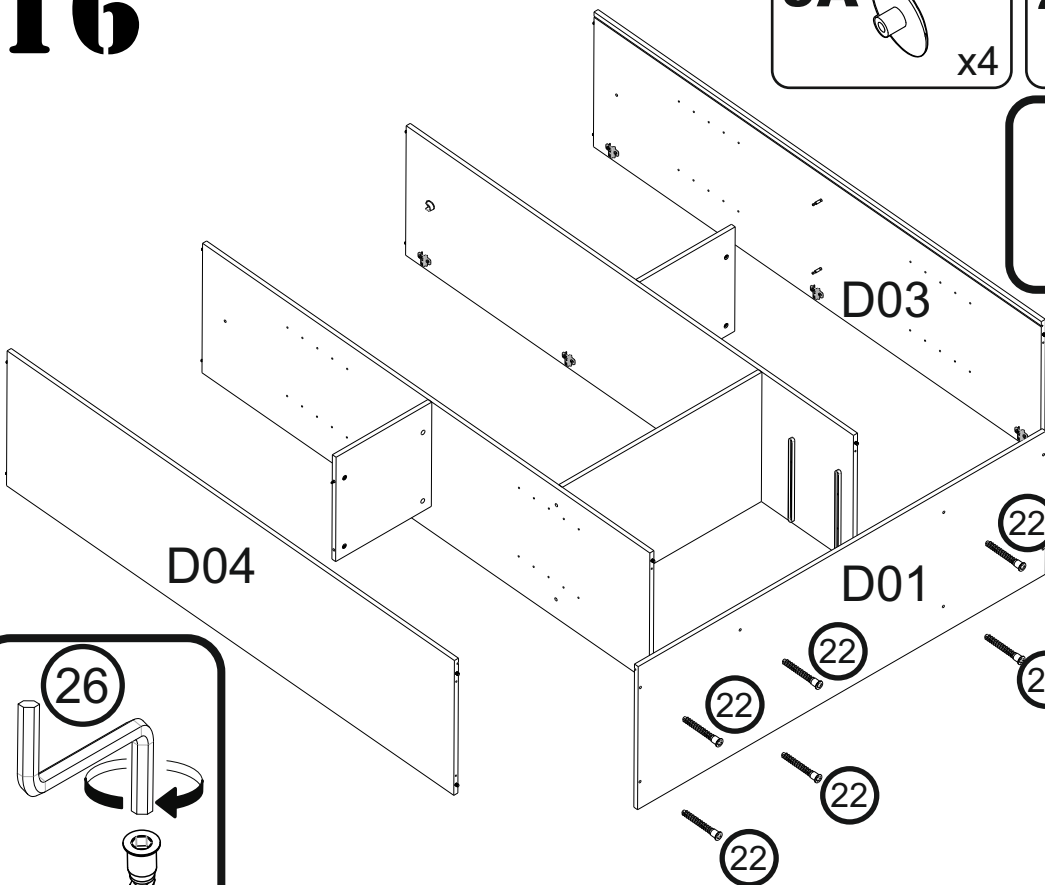

17 OPTION 'A'

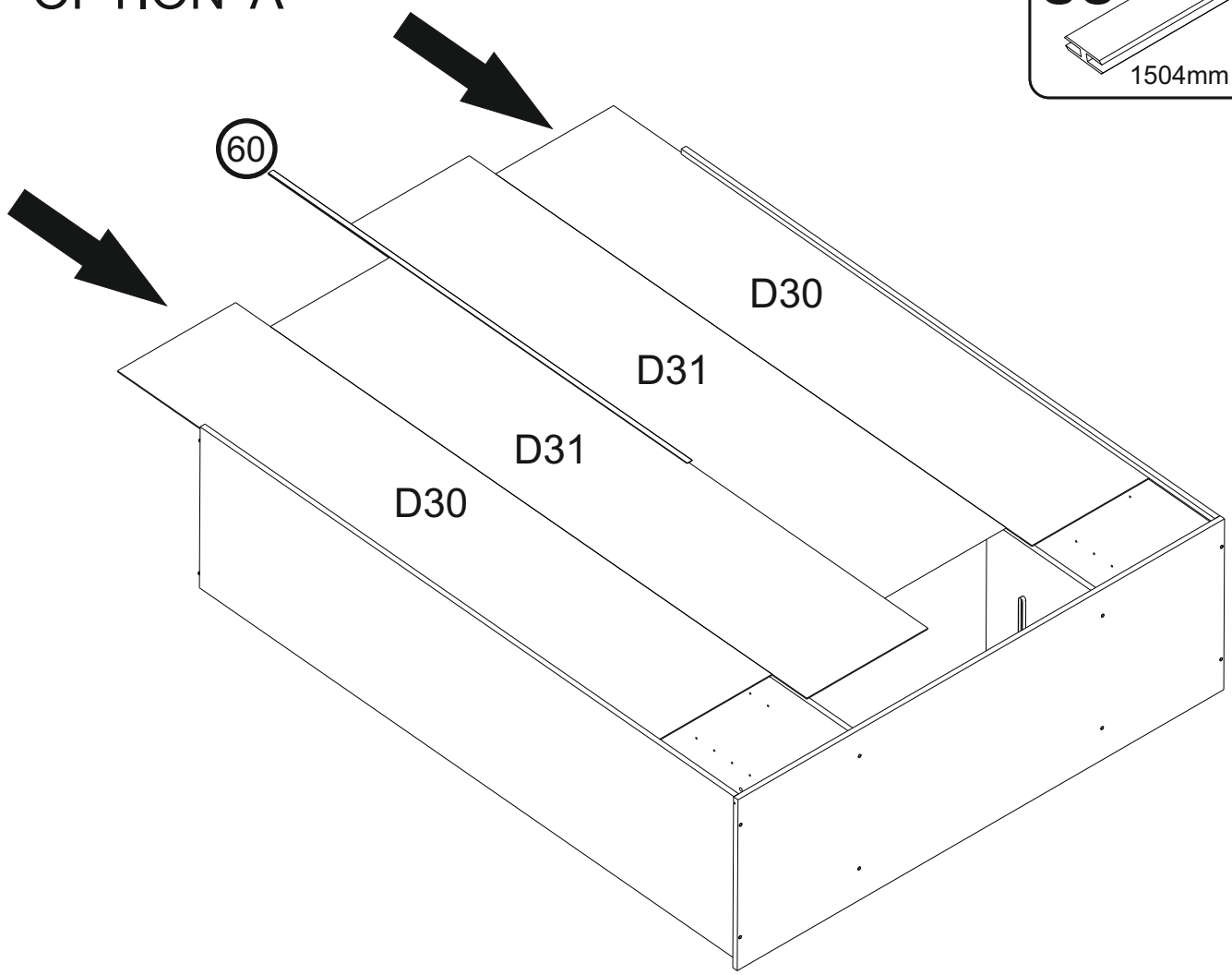
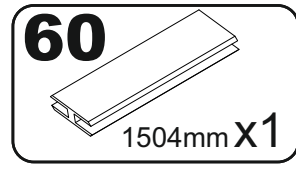

18

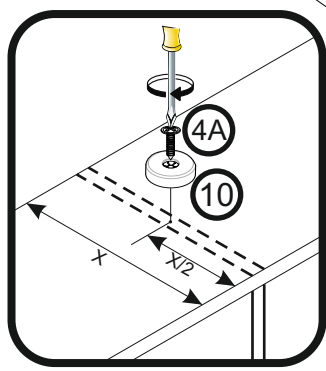
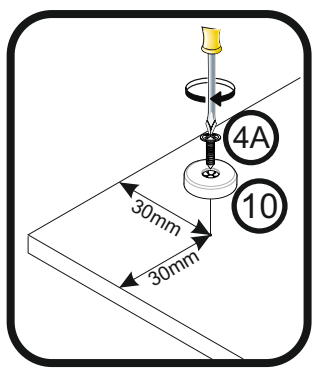
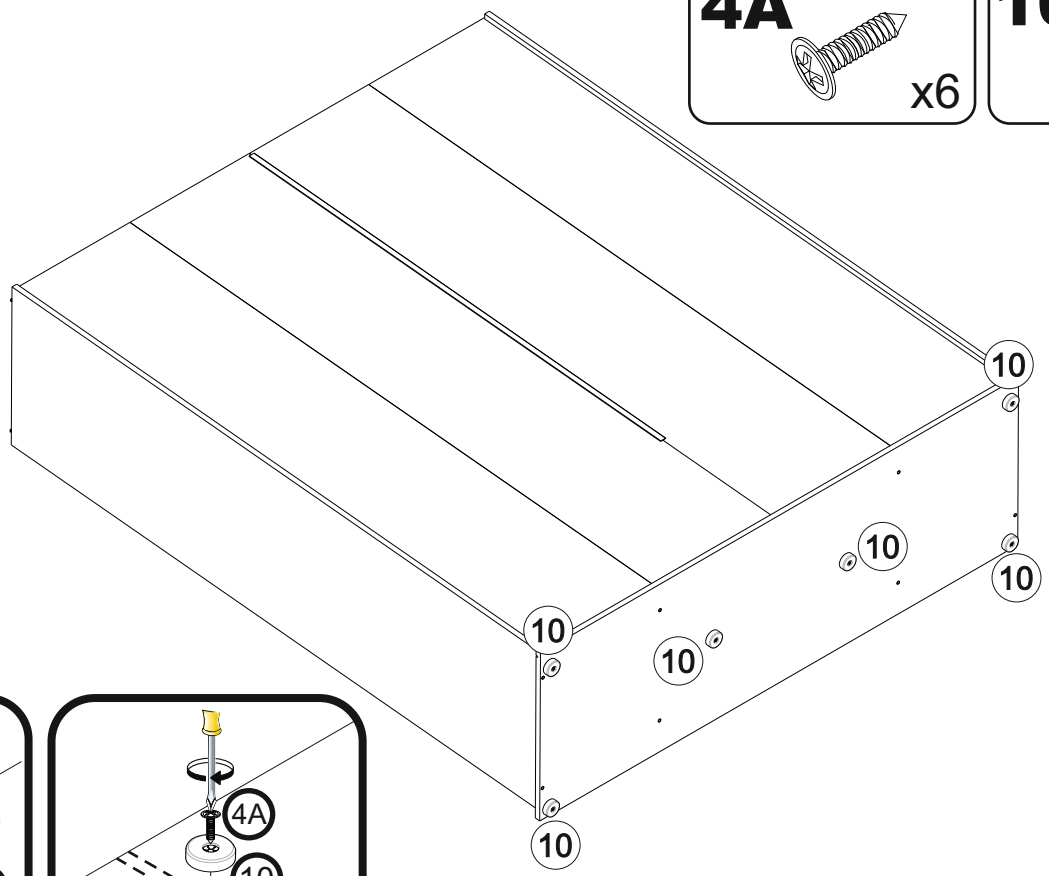
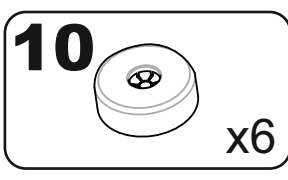
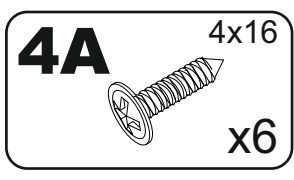

19 OPTION 'A'

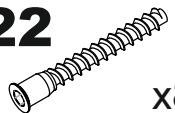
22  x8

22A  x8

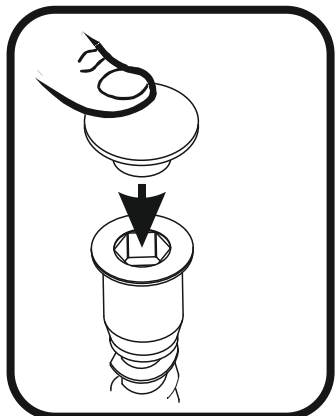
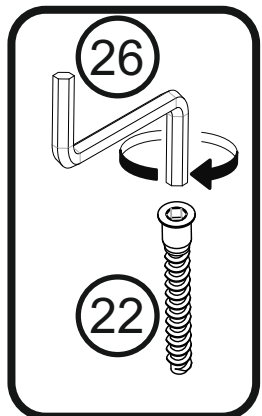
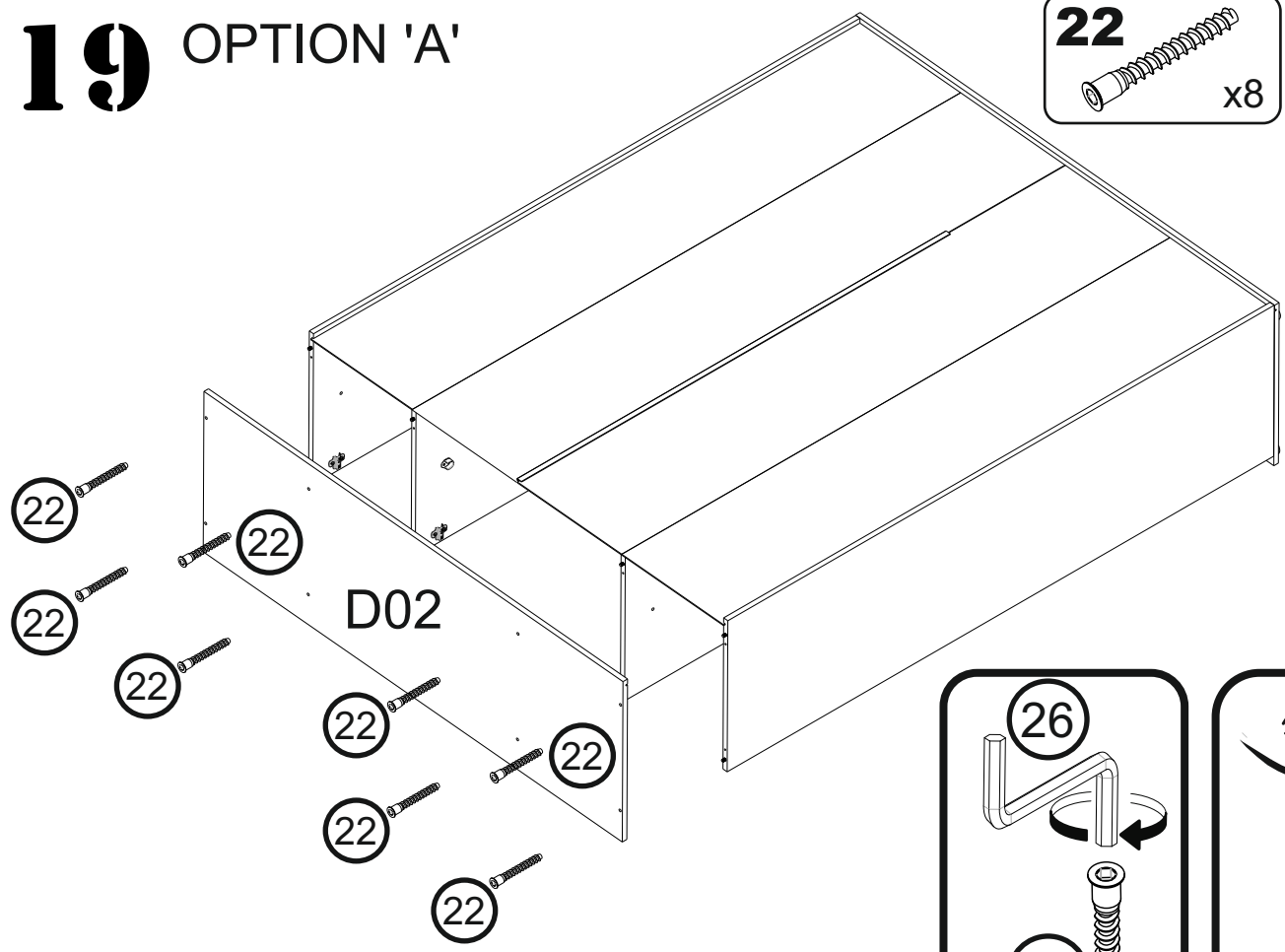

20 A=B

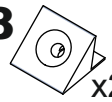
38  x24

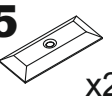
35  x24

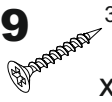
39  3x20
x64

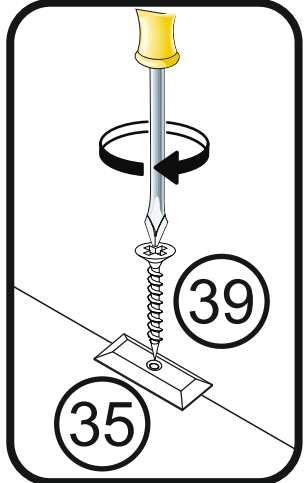
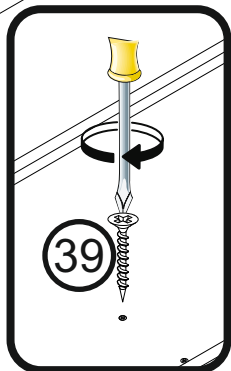
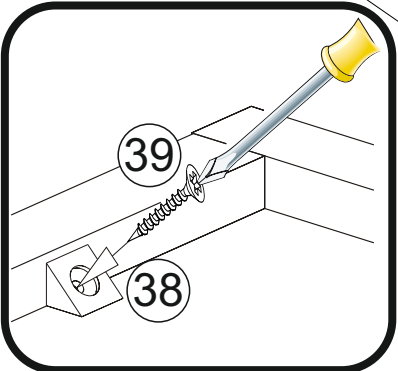
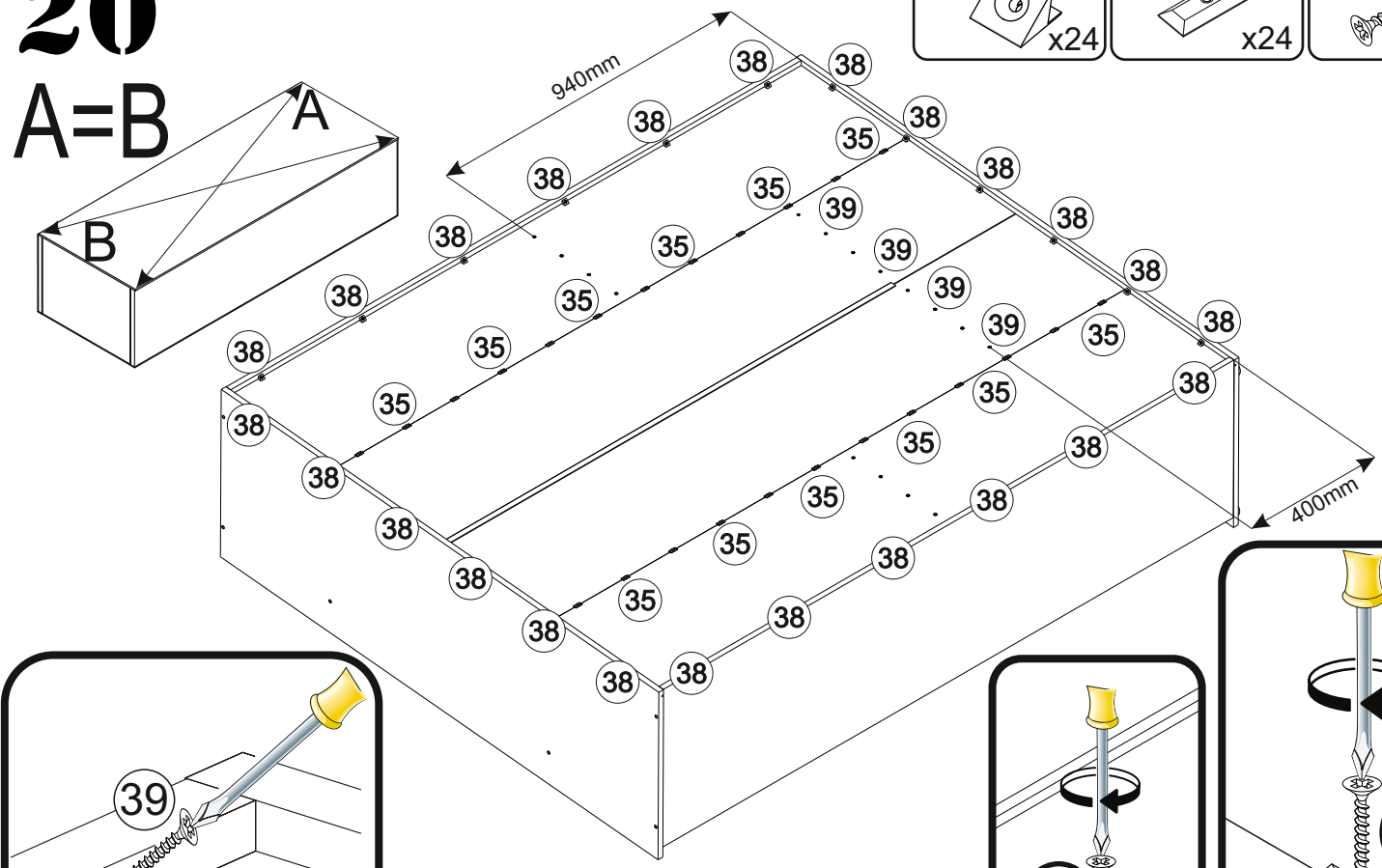

21 OPTION 'A'

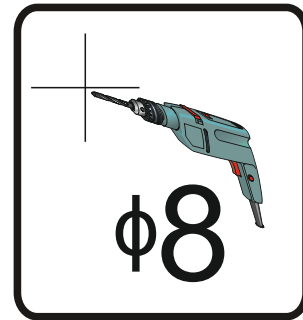
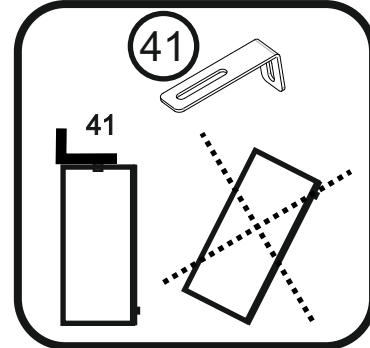
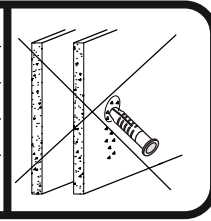
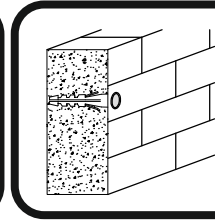
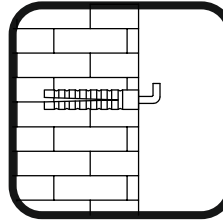
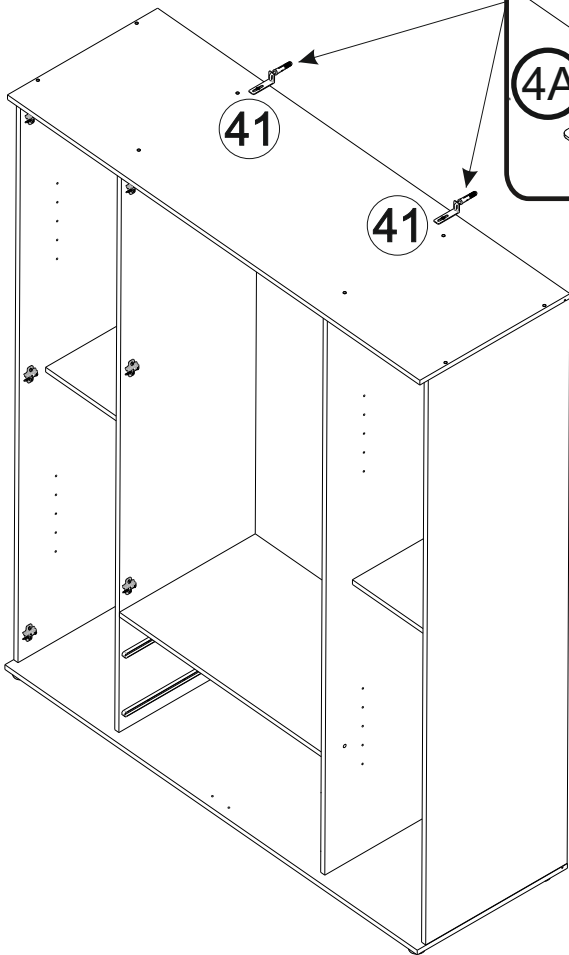
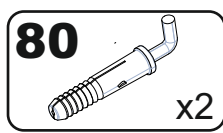
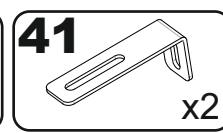
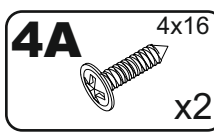
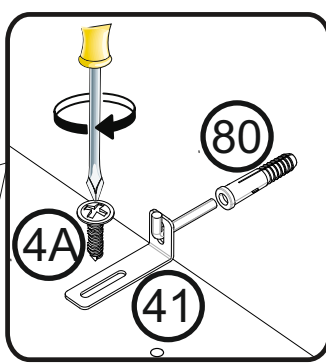

22

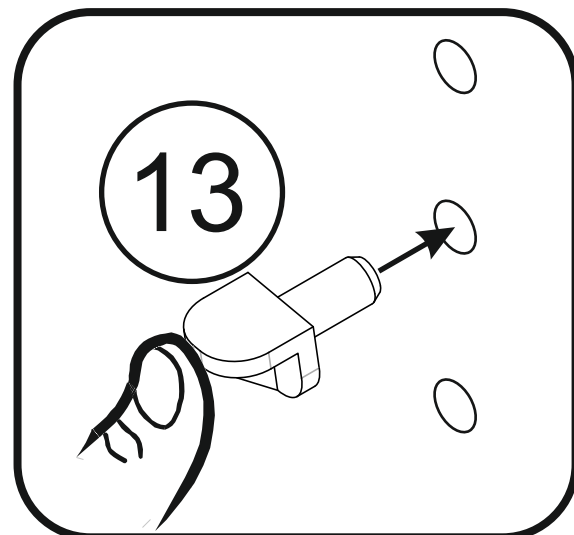
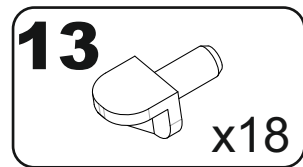
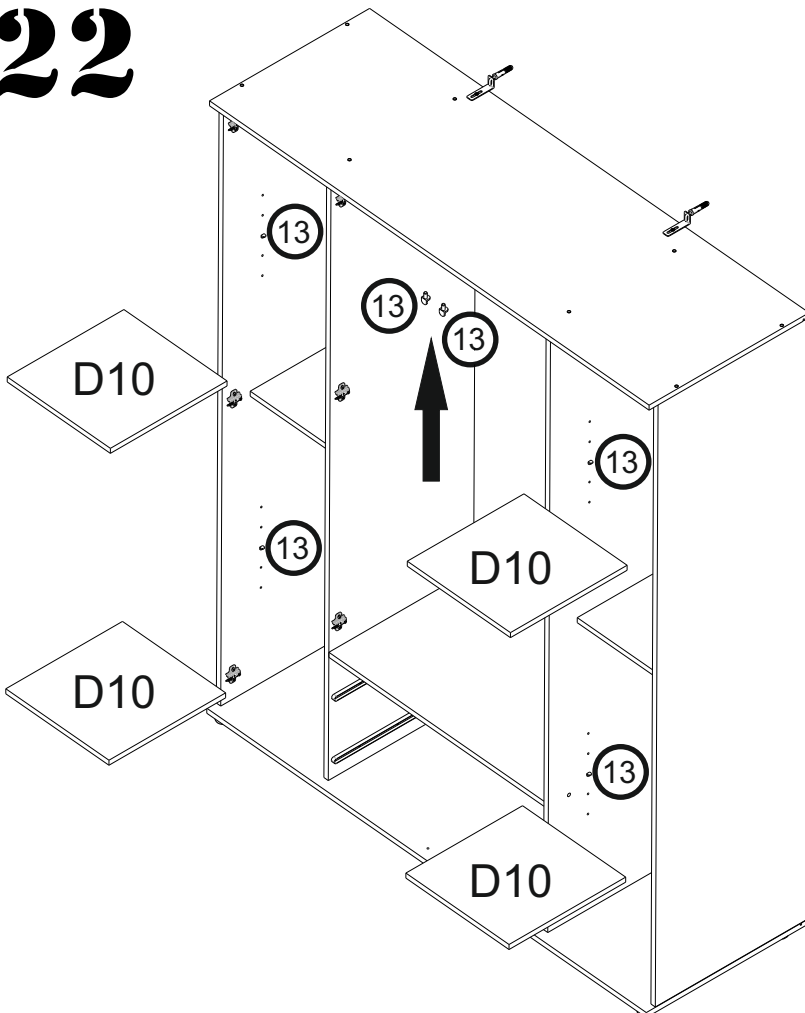

23 OPTION 'A'

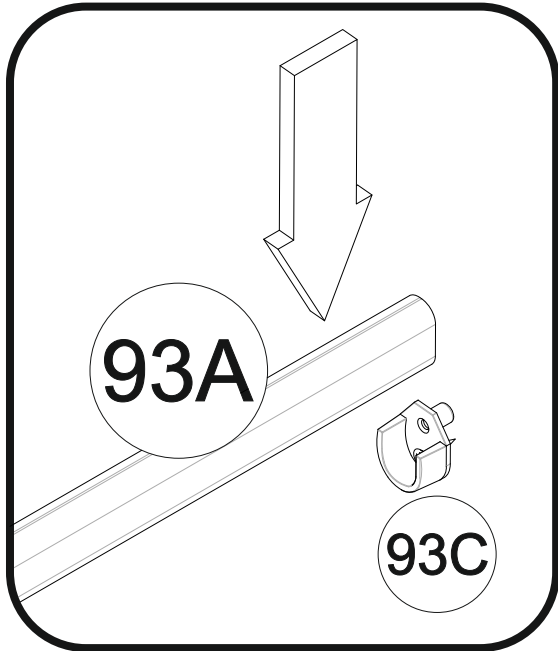
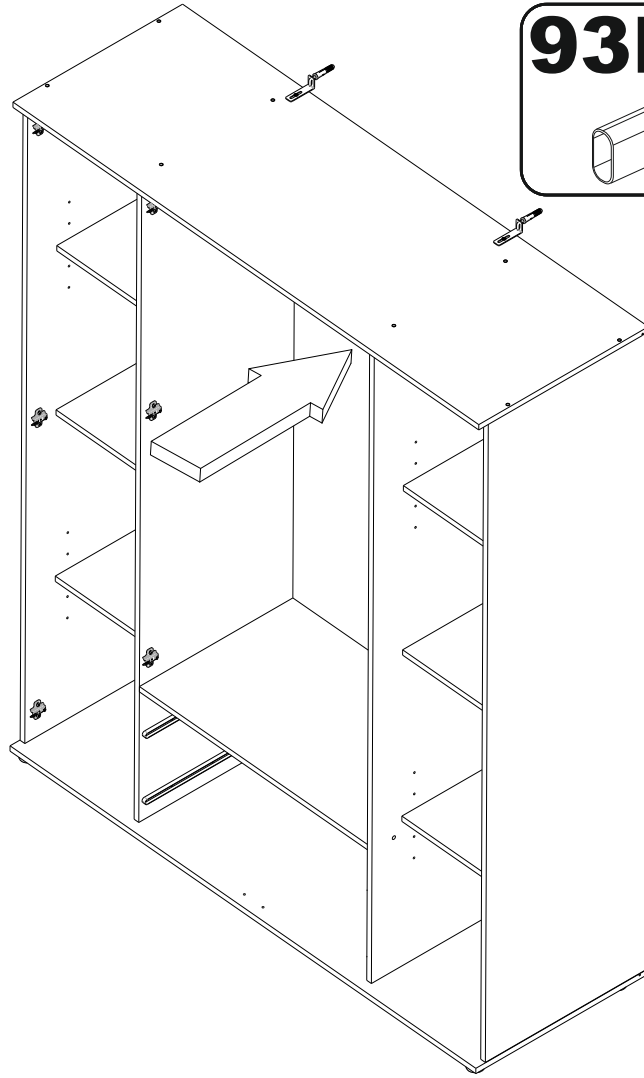
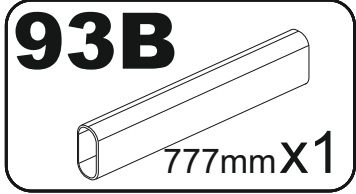

24

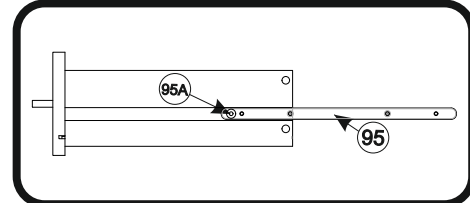
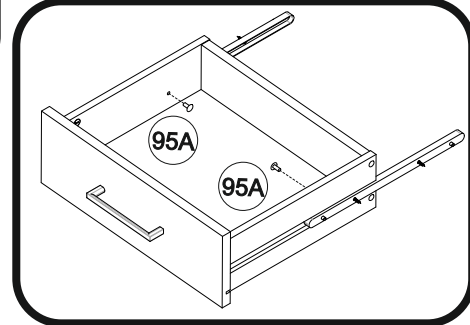
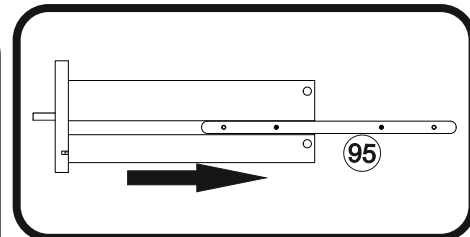
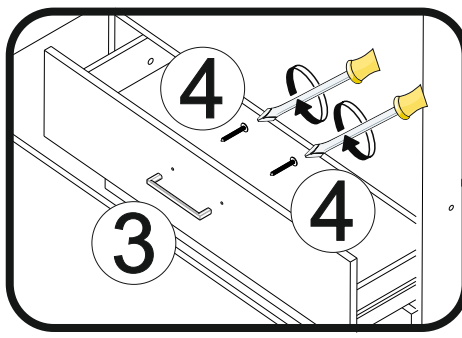
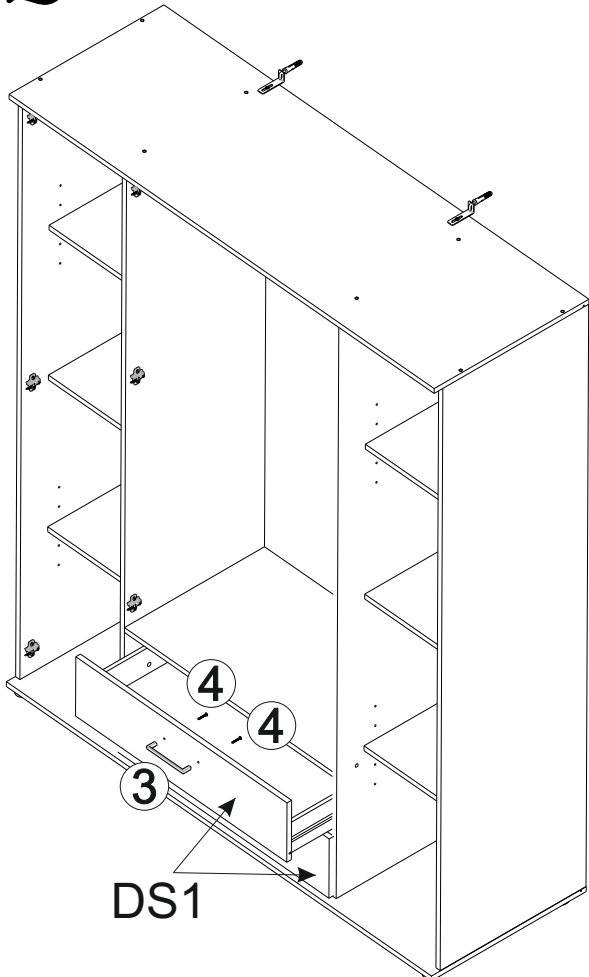
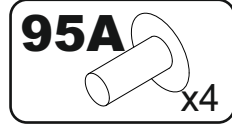
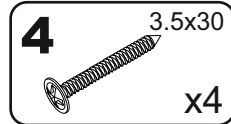
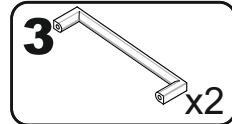

25 OPTION 'A'

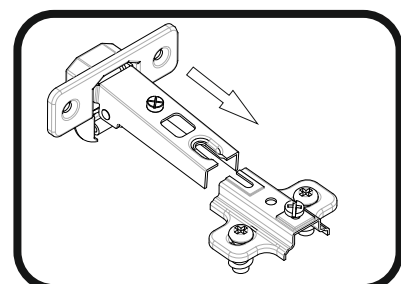
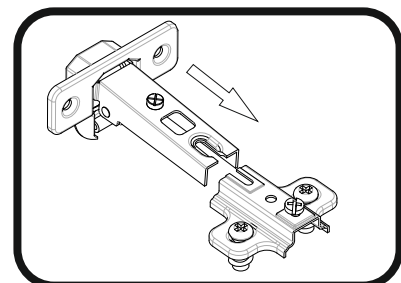
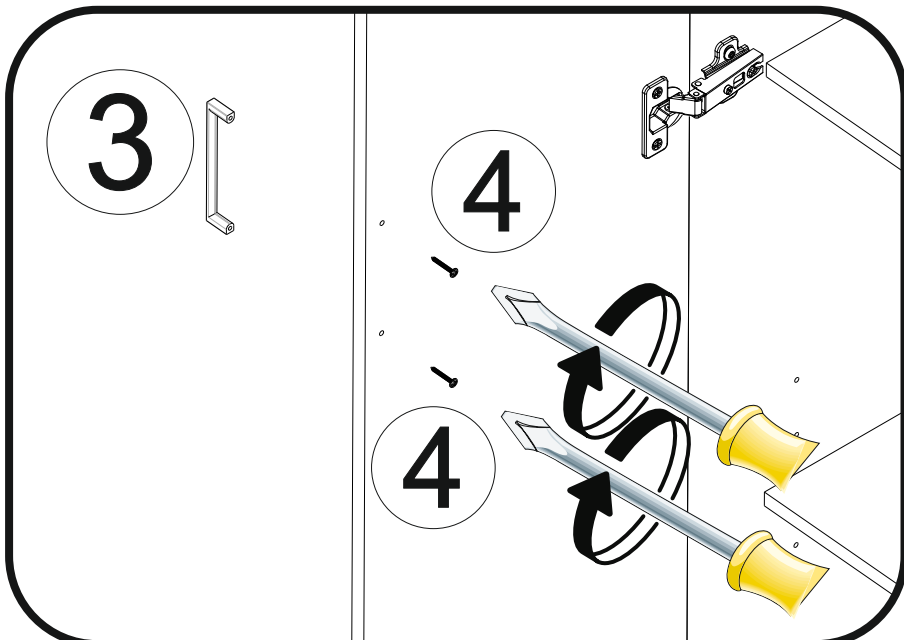
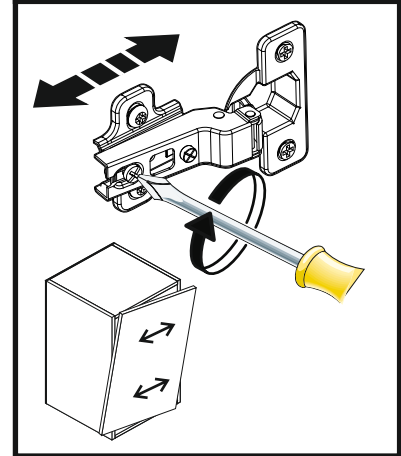
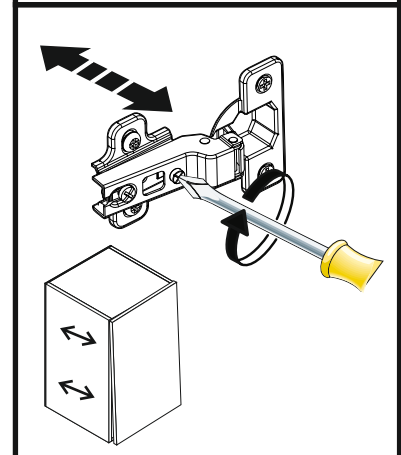
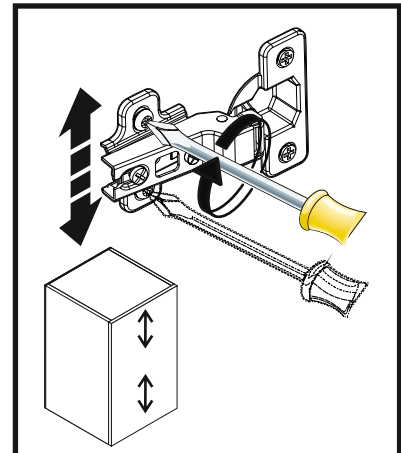
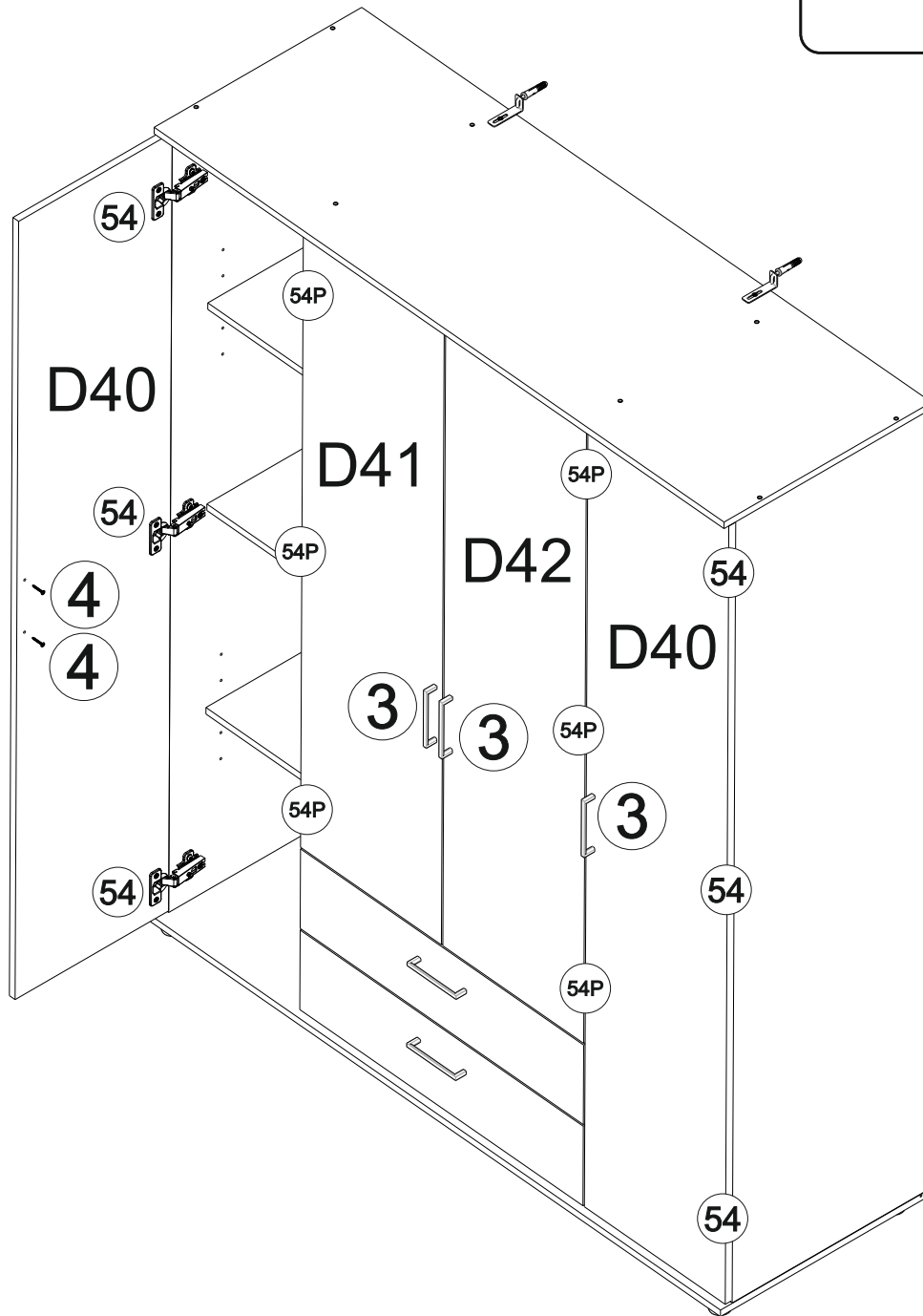
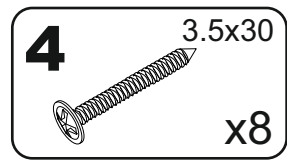
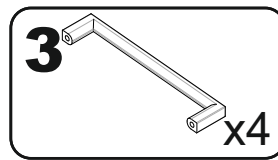

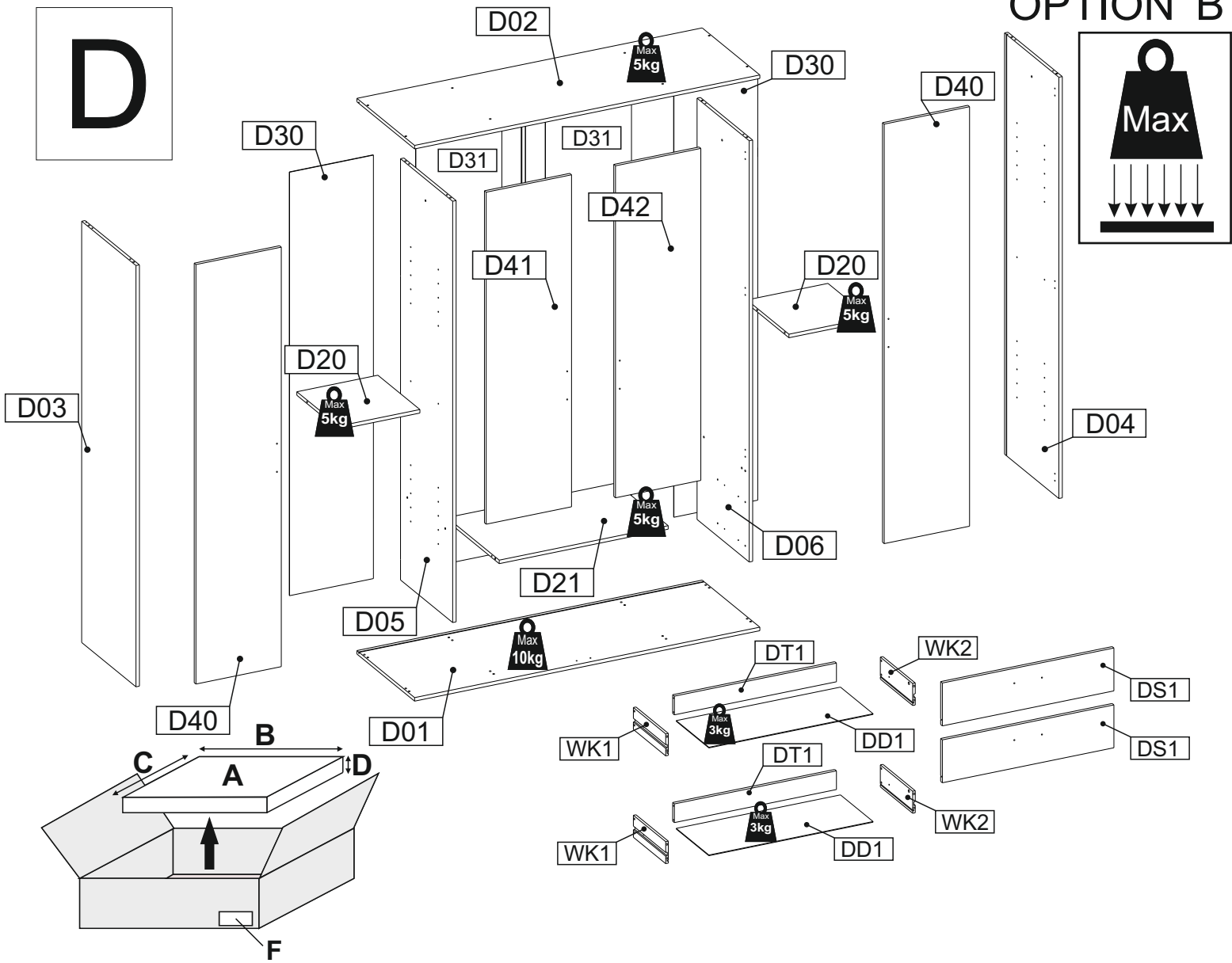

D

OPTION 'B'



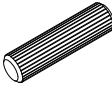
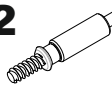
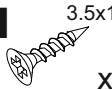

D01	1602	535	16	1	x/x
D02	1602	535	16	1	x/x
D03	1916	504	16	1	x/x
D04	1916	504	16	1	x/x
D05	1916	484	16	1	x/x
D06	1916	484	16	1	x/x
D20	376	390	16	2	x/x
D21	784	484	16	1	x/x
D30	1926	389	3	2	x/x
D31	1926	399	3	2	x/x
D40	1908	396	16	2	x/x
D41	1510	396	16	1	x/x
D42	1510	396	16	1	x/x
DD1	762	303	3	2	x/x
DS1	796	195	16	2	x/x
DT1	752	85	16	2	x/x
WK1	300	100	12	2	x/x
WK2	300	100	12	2	x/x

1 OPTION 'B'

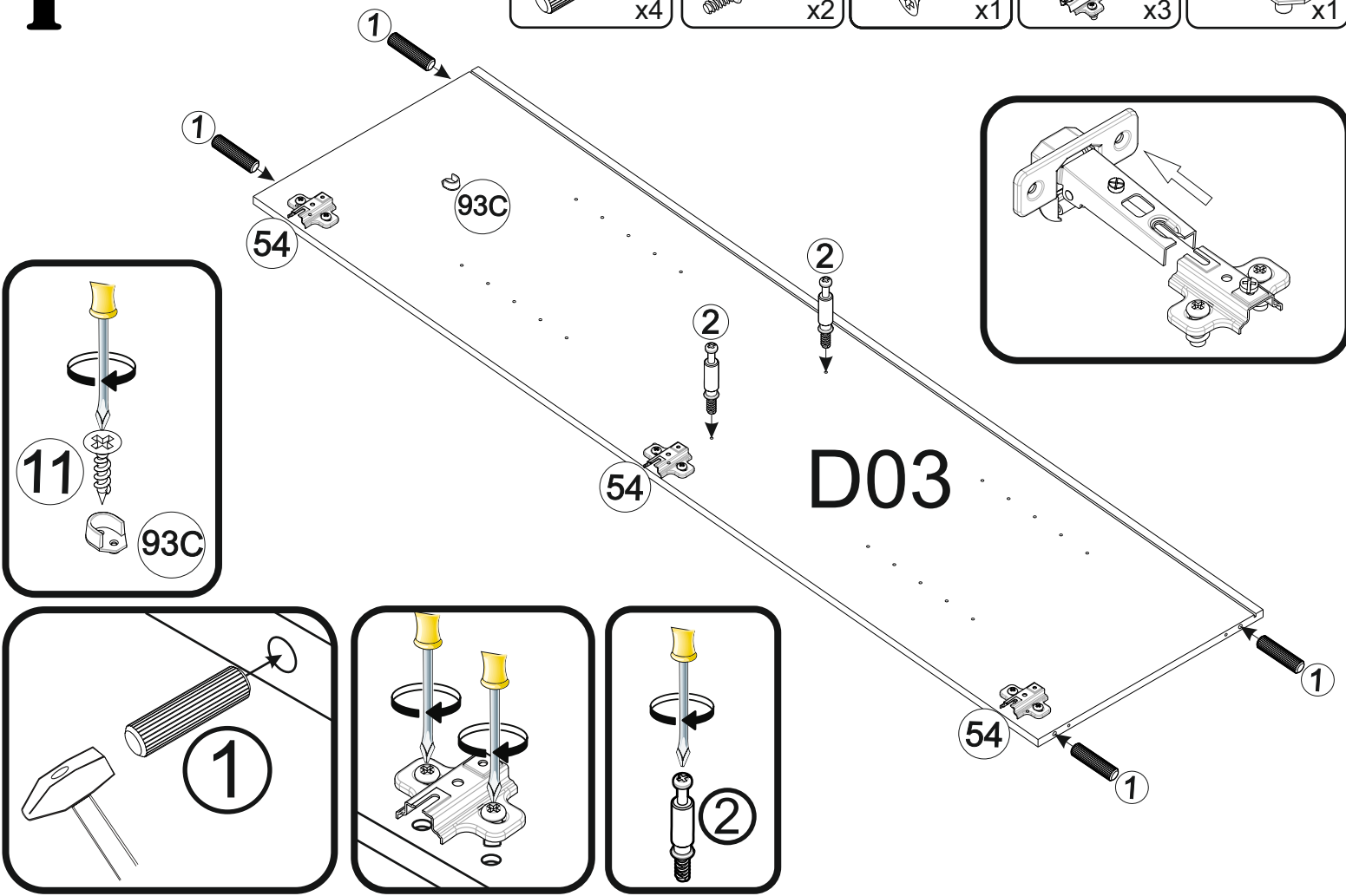
- 1**  x4
- 2**  x2
- 11**  3.5x13 x1
- 54**  $\varnothing 35$ x3
- 93C**  x1

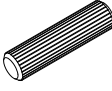
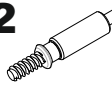
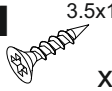

2

- 1**  x4
- 2**  x2
- 11**  3.5x13 x1
- 54**  $\varnothing 35$ x3
- 93C**  x1

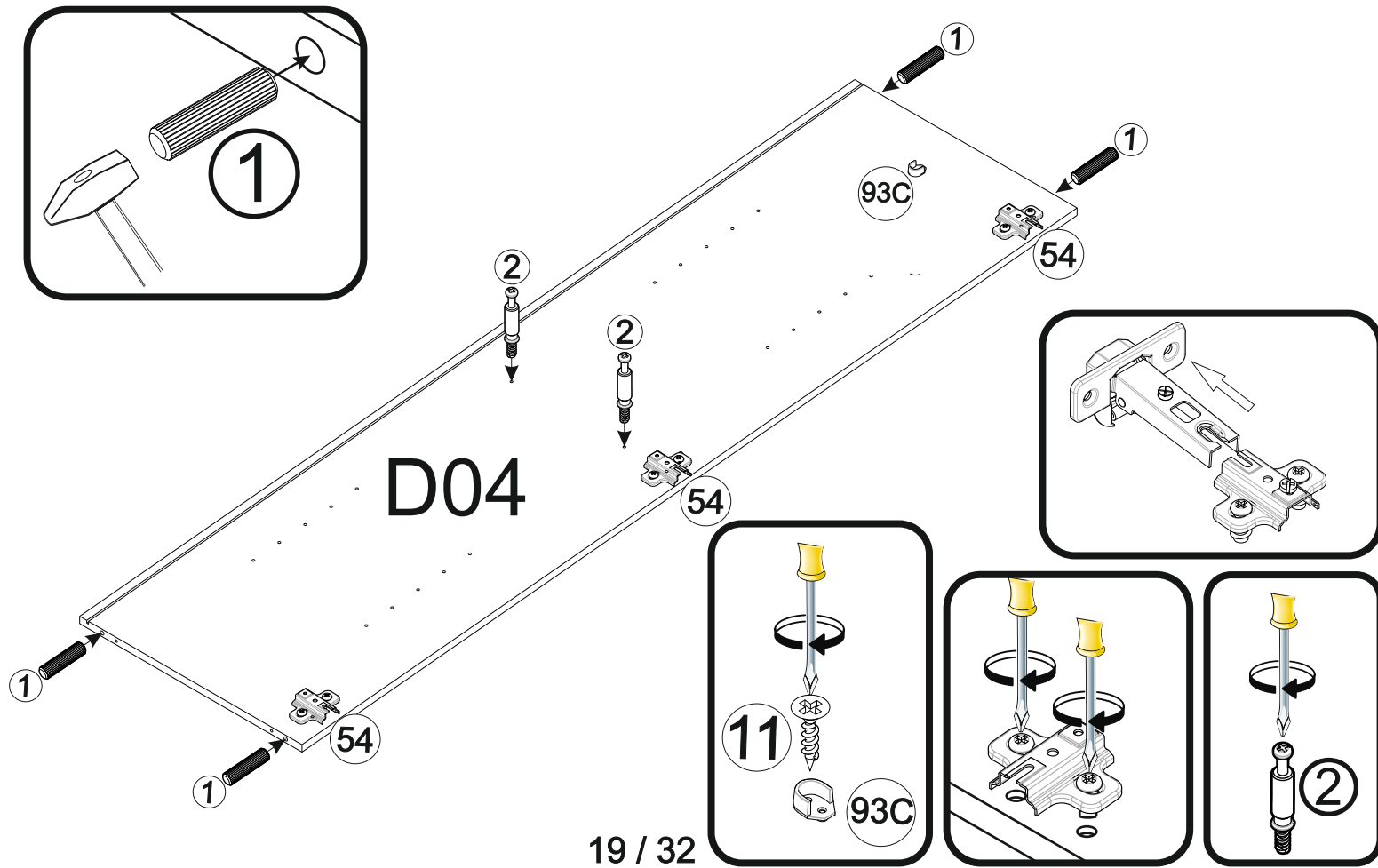





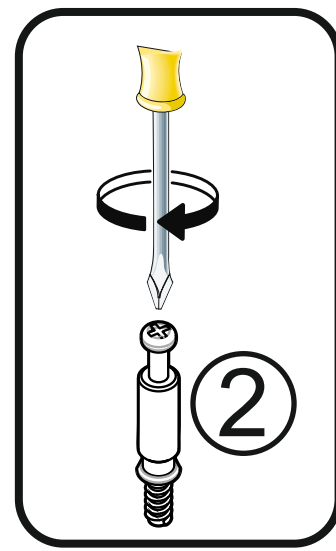
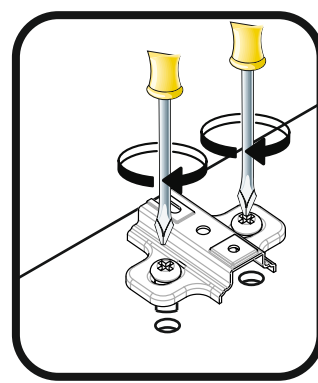
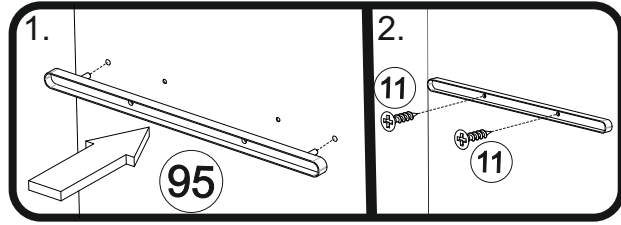
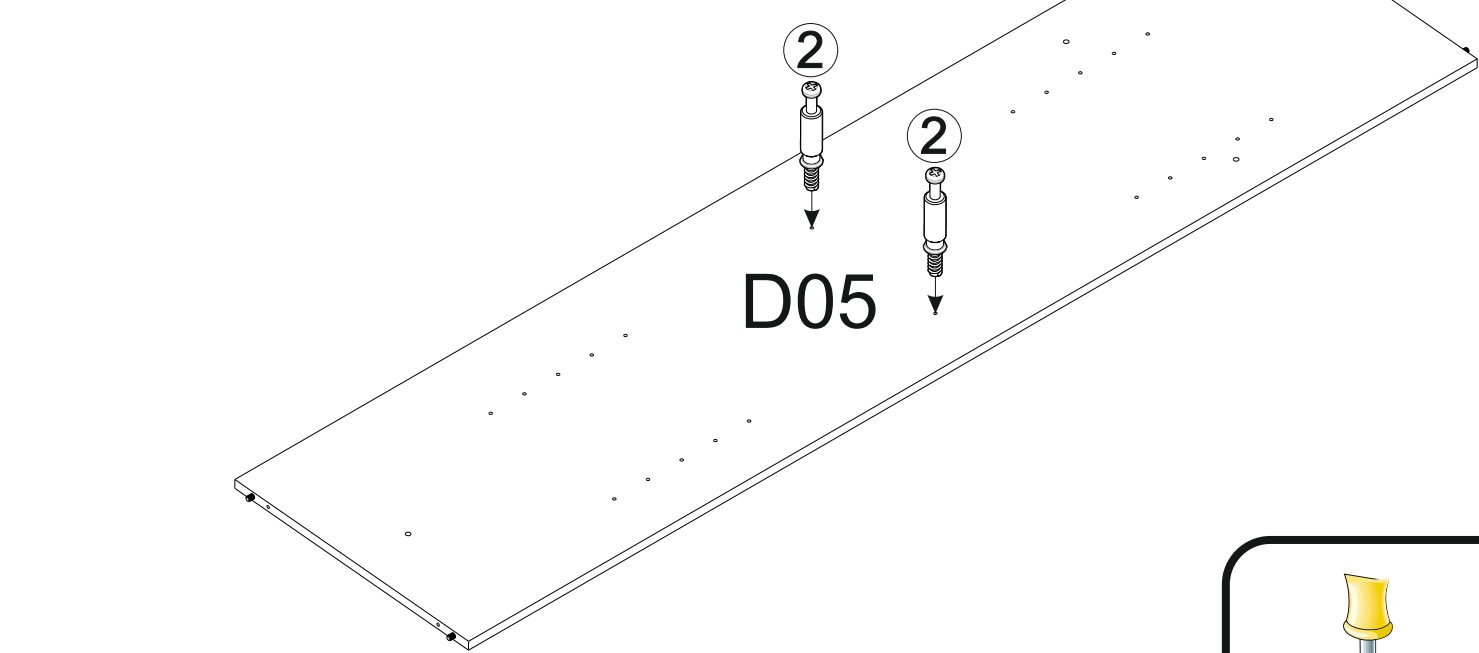
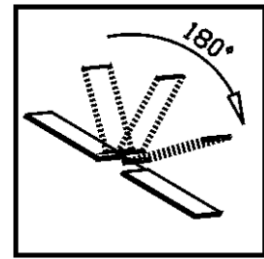
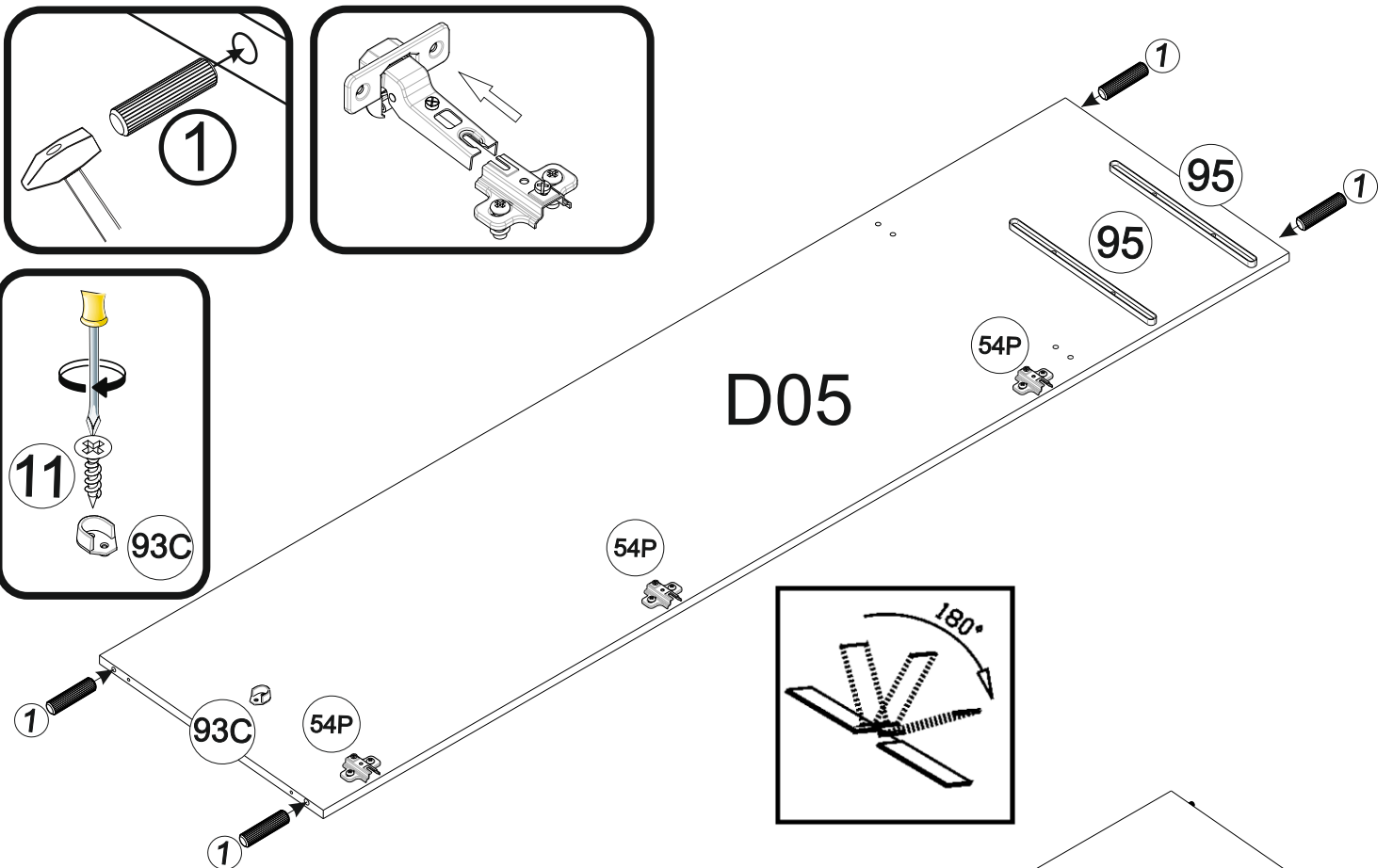
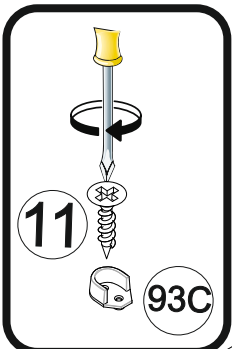
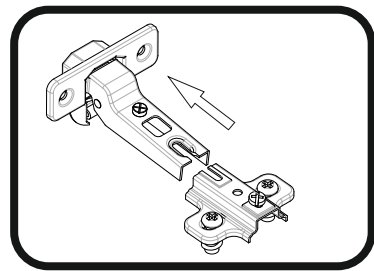
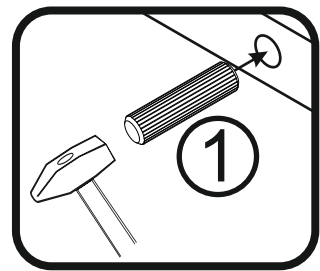
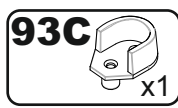
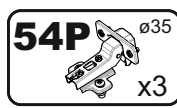
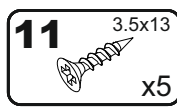
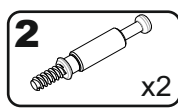
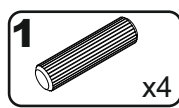

3

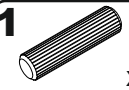
OPTION 'B'



4 OPTION 'B'

- 1**  x4
- 2**  x2
- 11**  3.5x13 x5
- 54P**  $\varnothing 35$ x3
- 93C**  x1
- 95**  x2

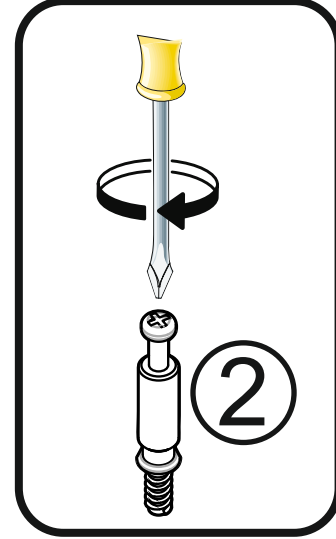
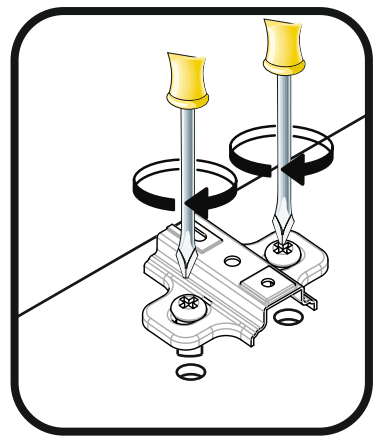
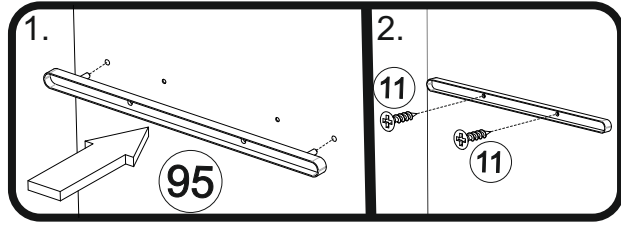
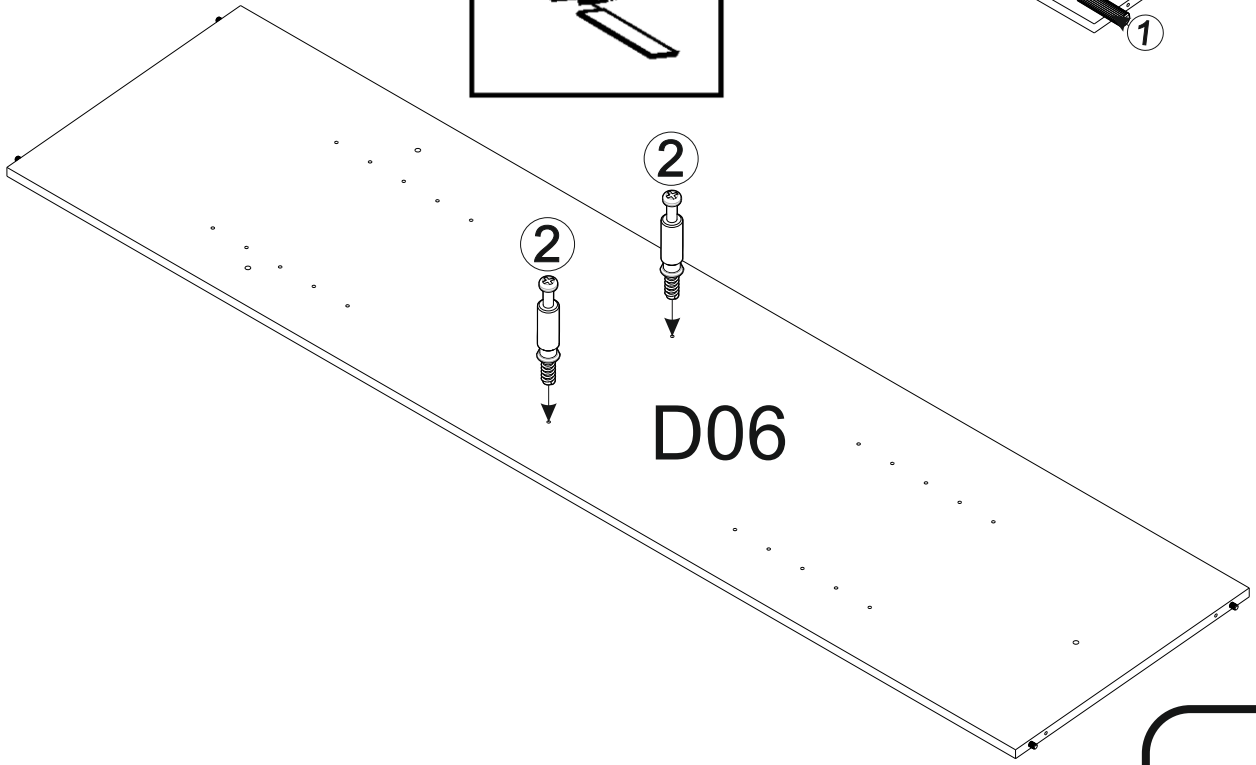
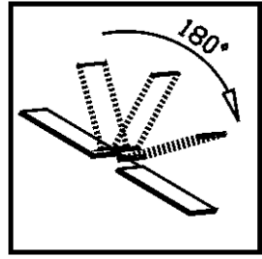
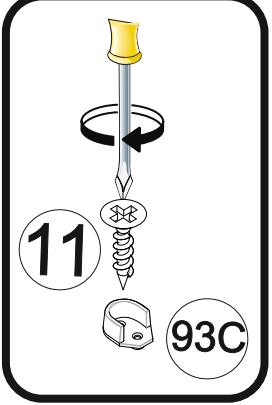
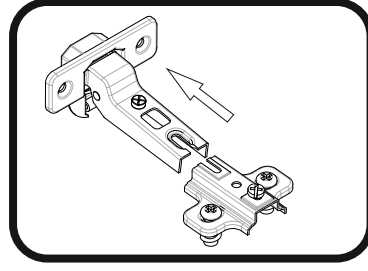
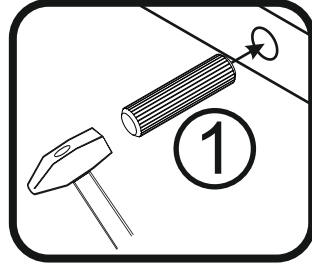
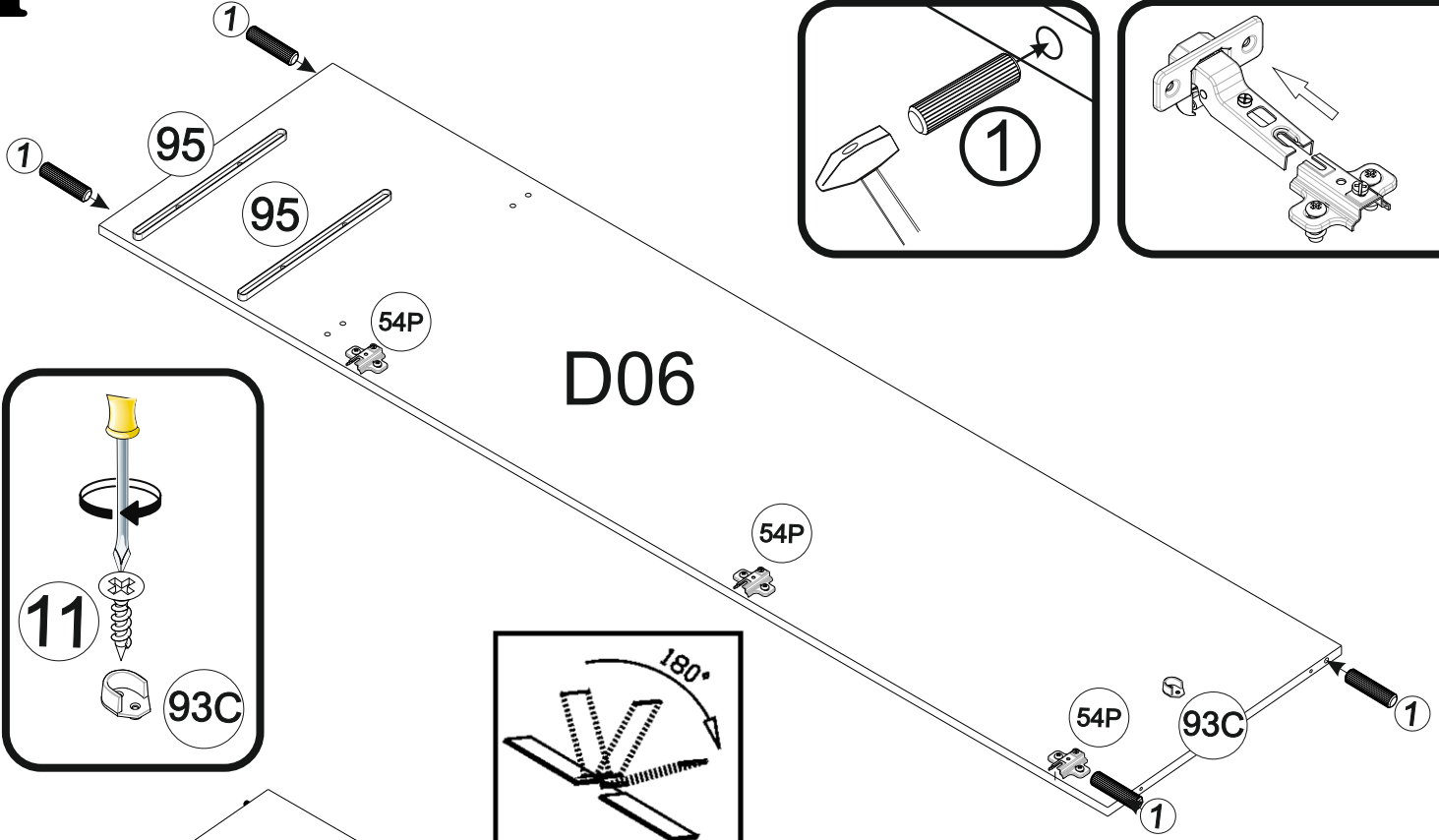

5 OPTION 'B'

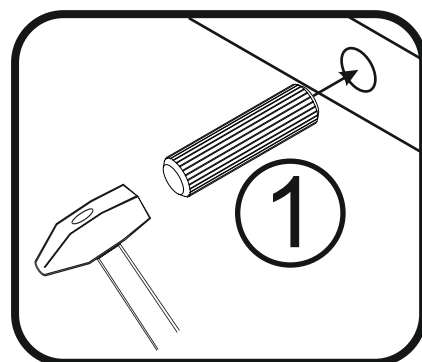
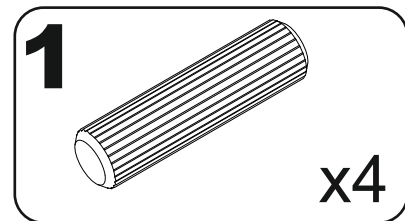
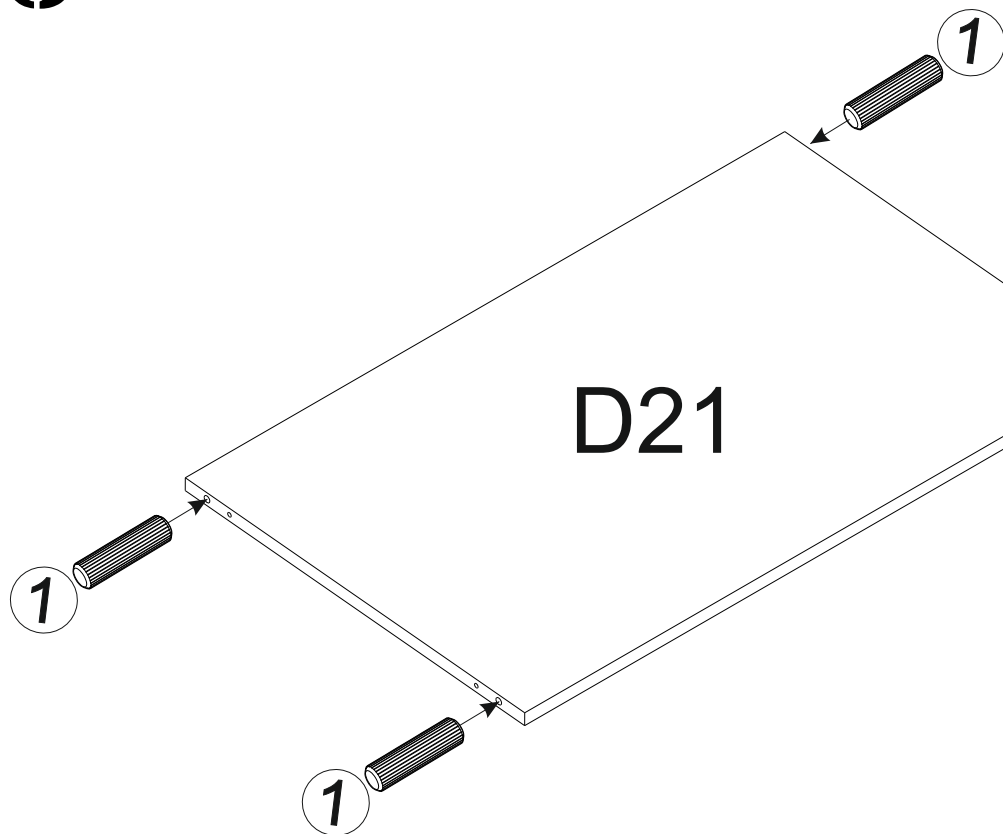

6

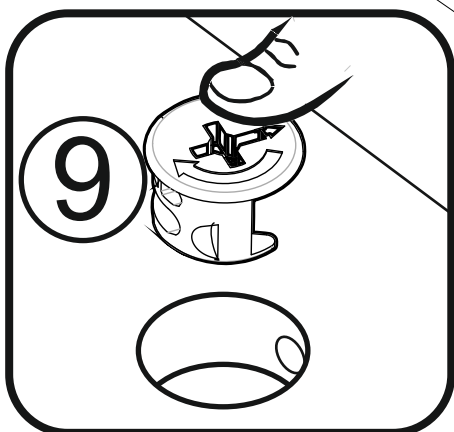
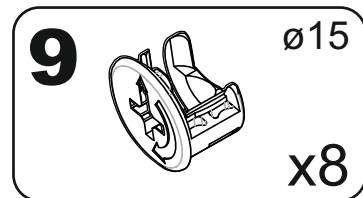
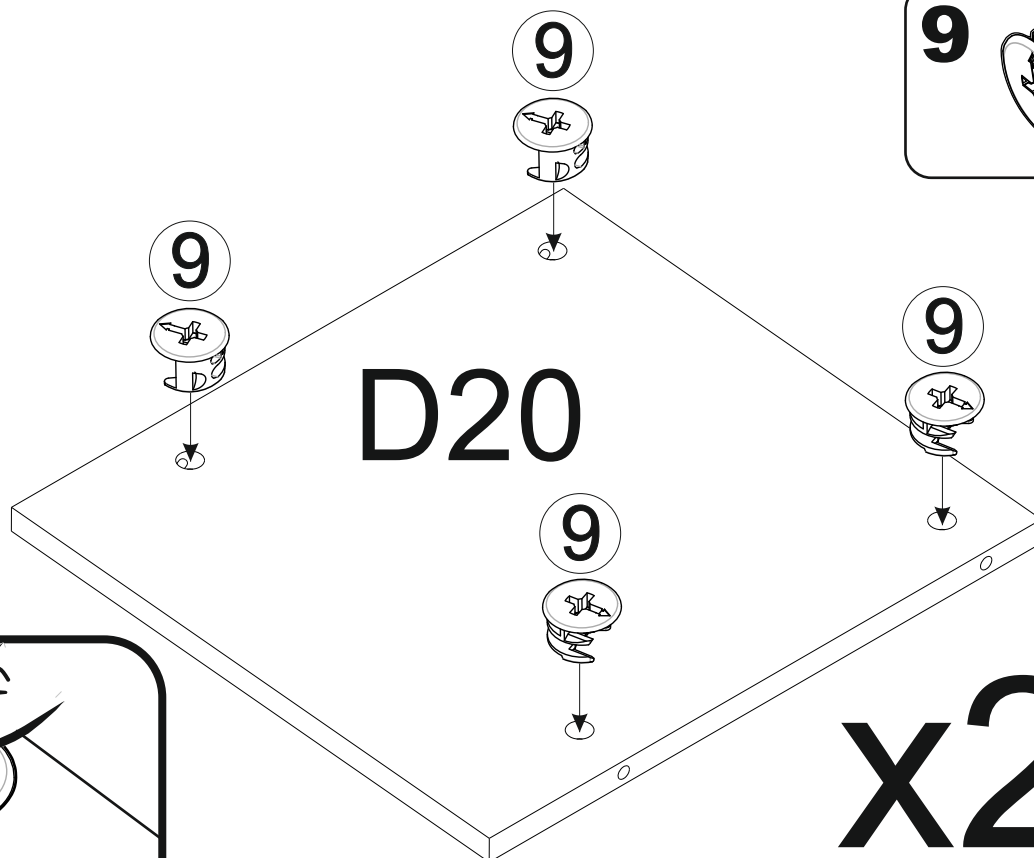

7 OPTION 'B'

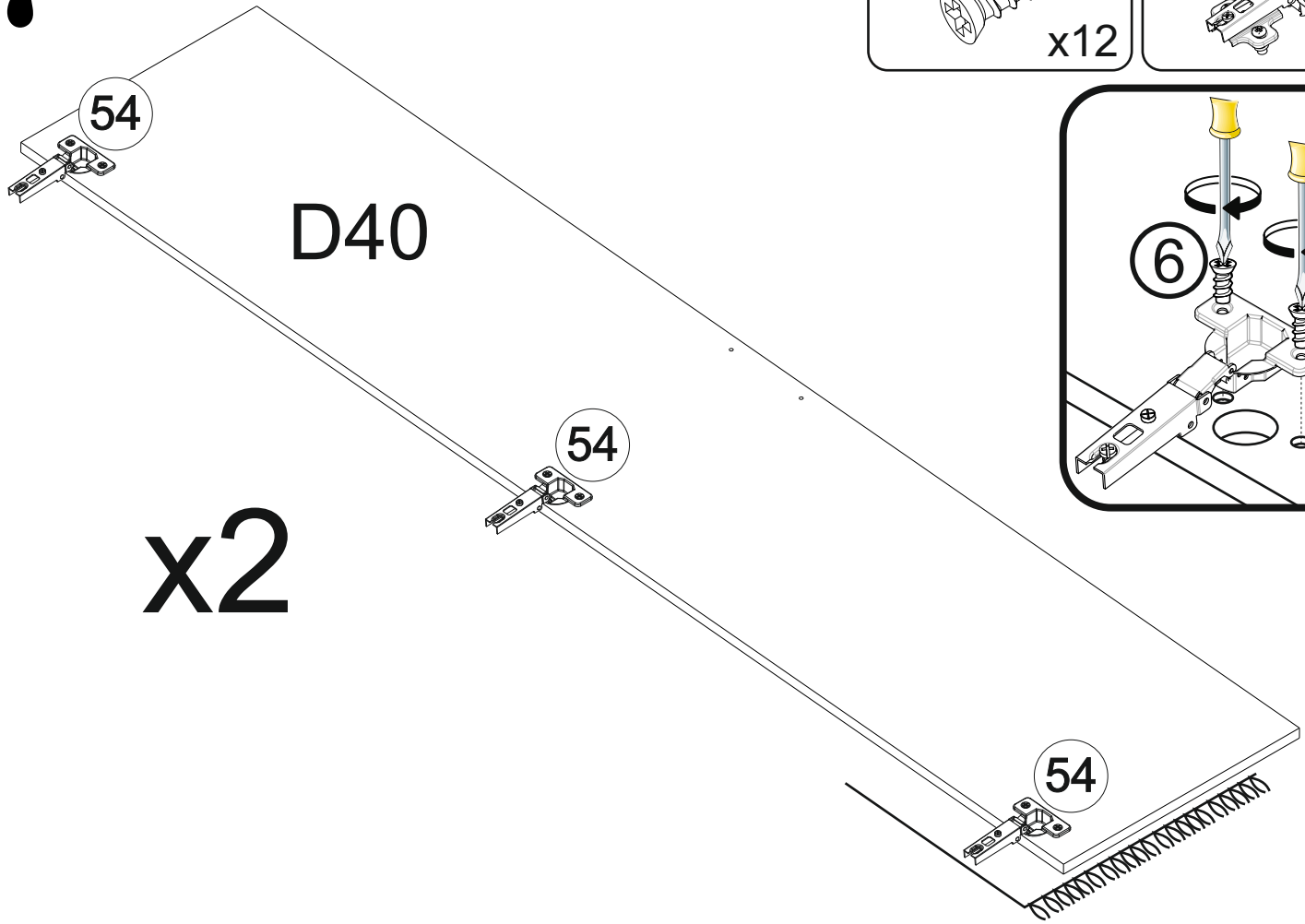

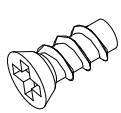
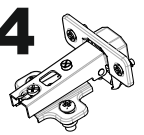
6	5x11	54	ø35
	x12		x6

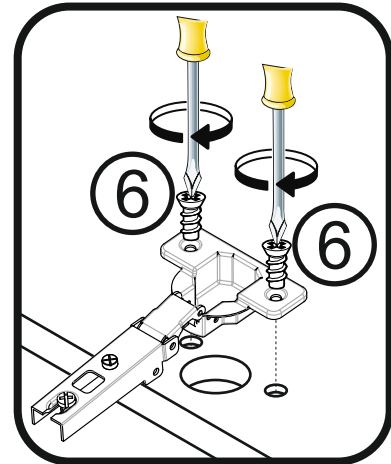

8

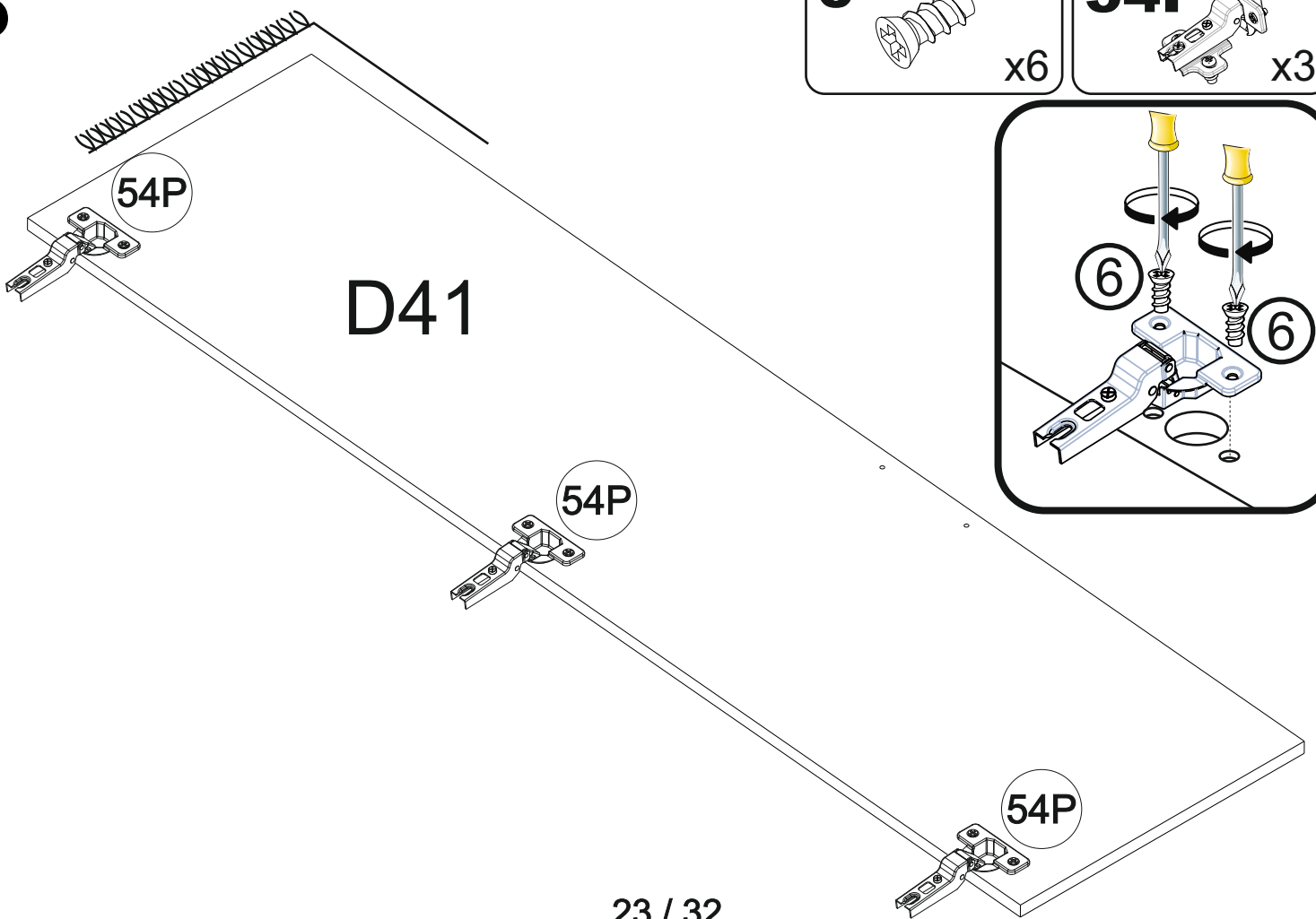

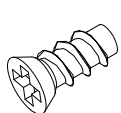
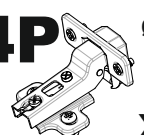
6	5x11	54P	ø35
	x6		x3

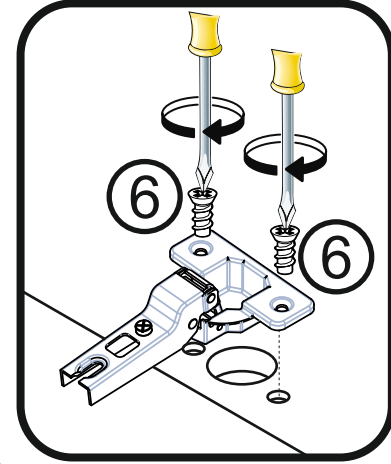

9 OPTION 'B'

6 5x11 x6

54P ø35 x3

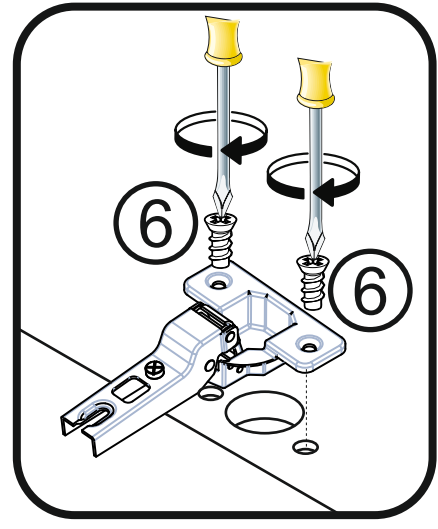
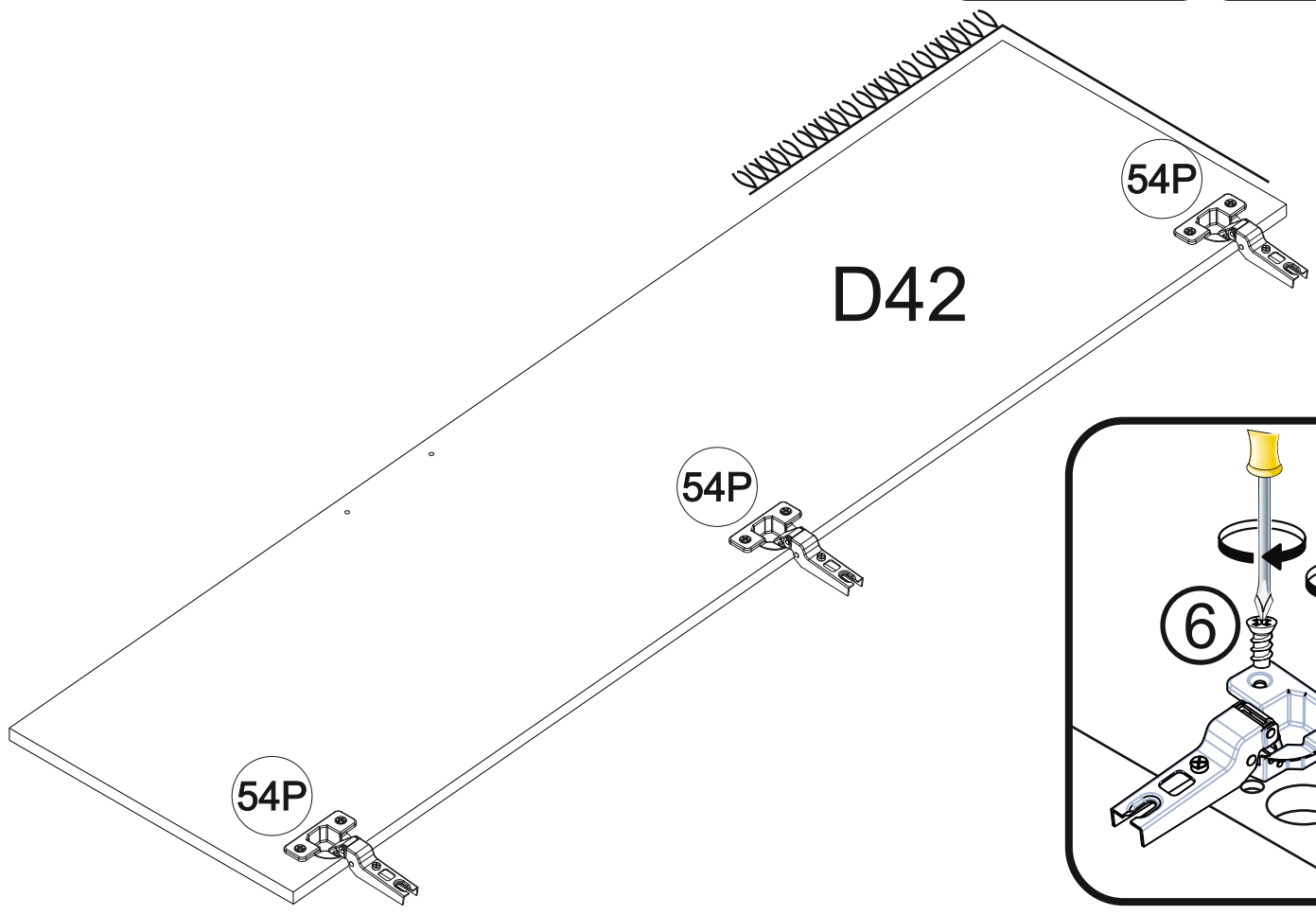
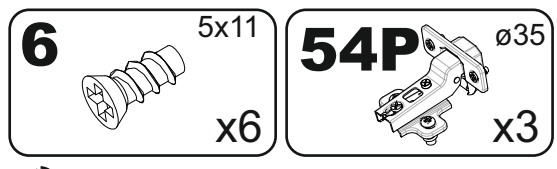

10

2 x4

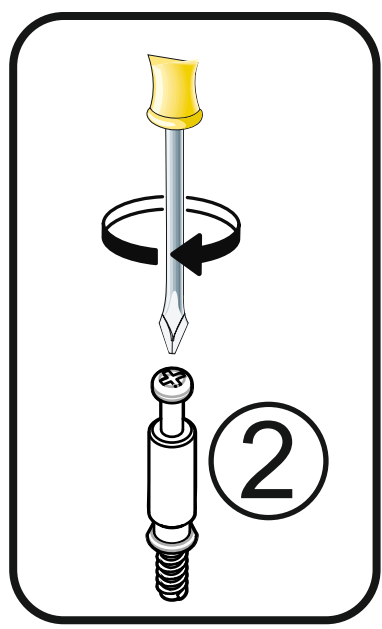
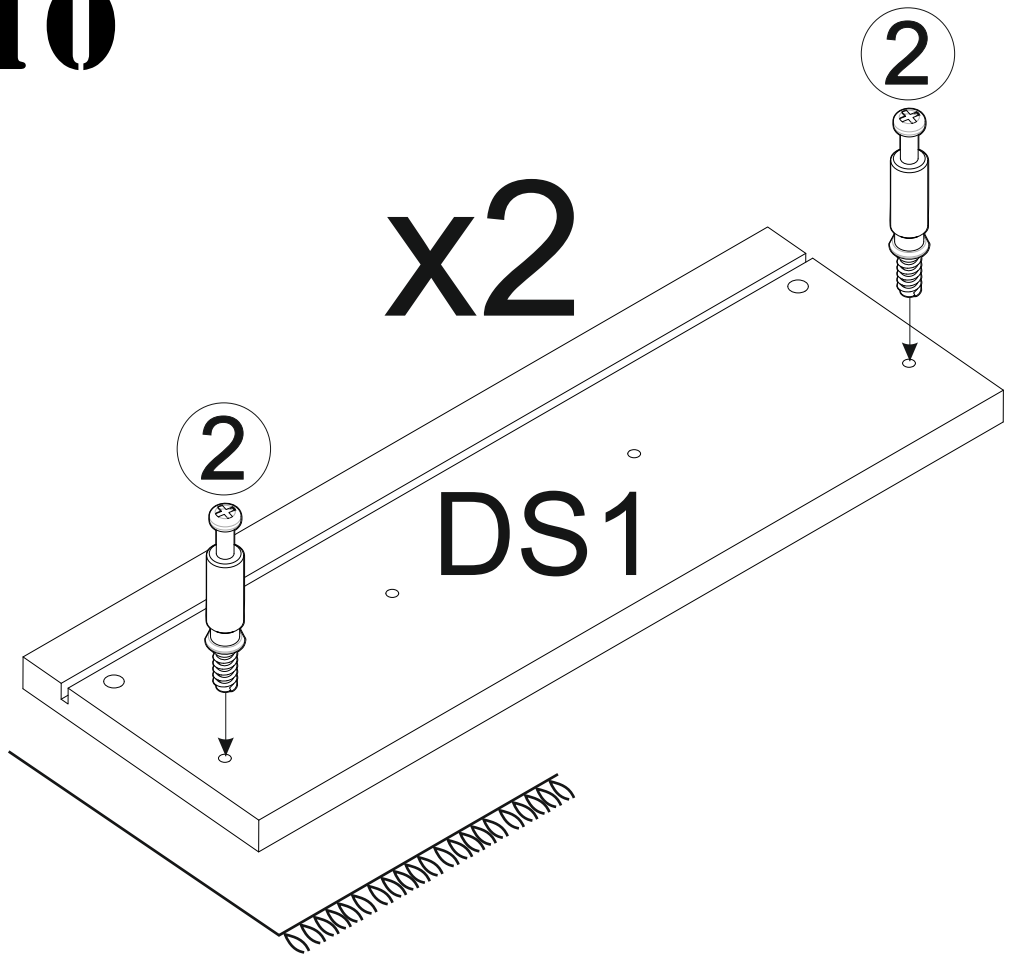
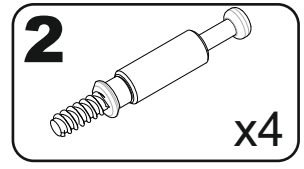

11 OPTION 'B'

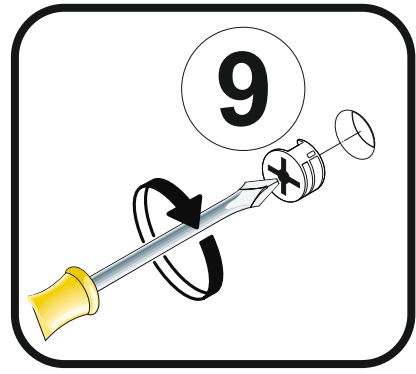
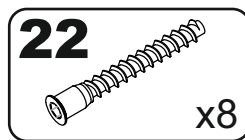
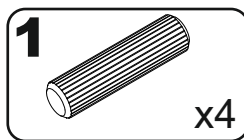

DT1

22

22

WK2 x2

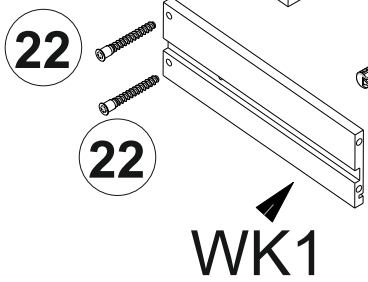

WK1

9

DS1

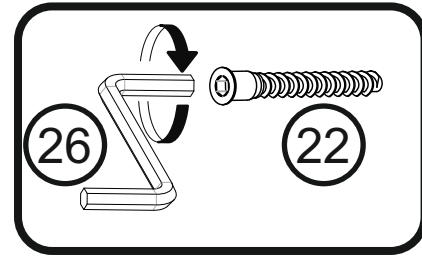
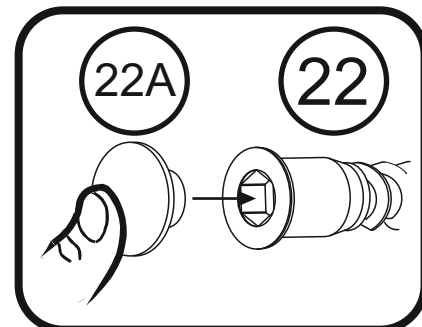

12

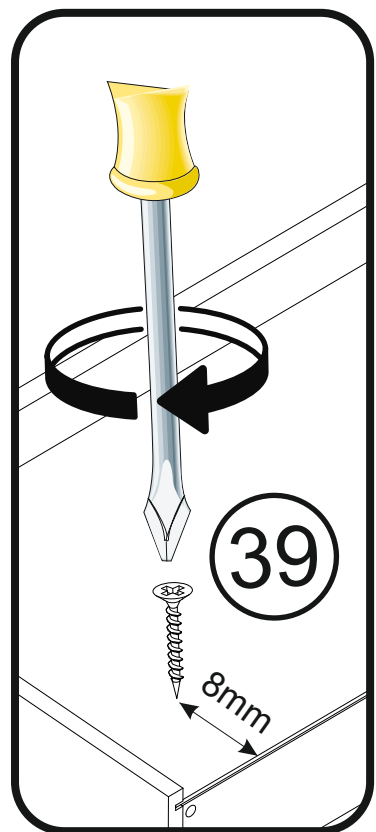
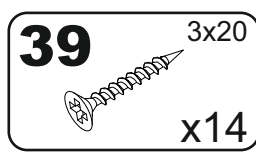

39

8mm

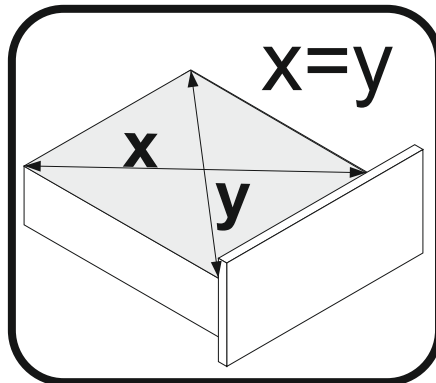

x=y

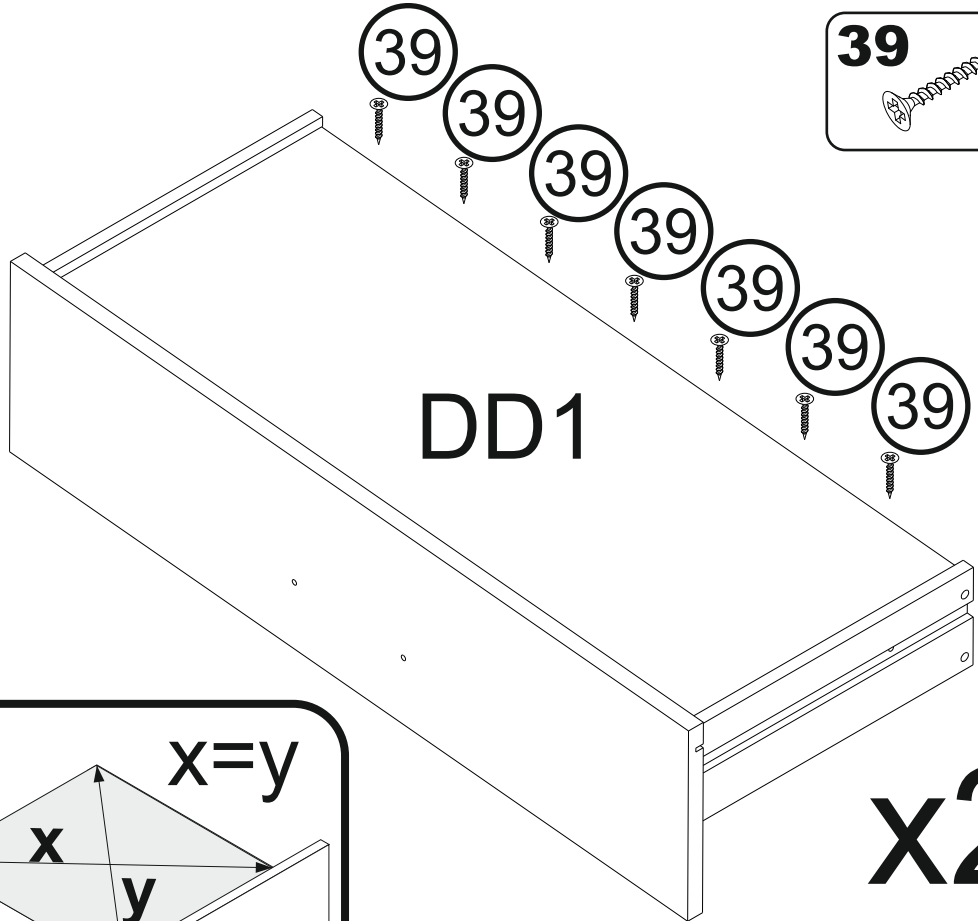

DD1

x2

13 OPTION 'B'

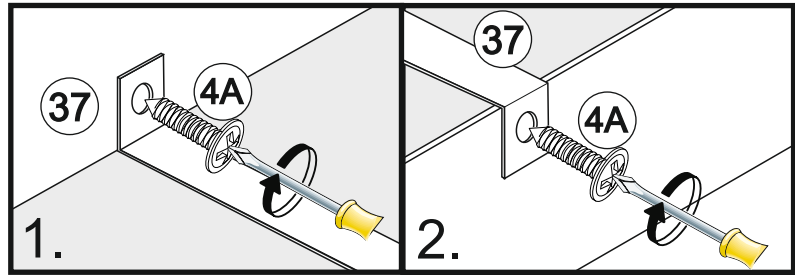
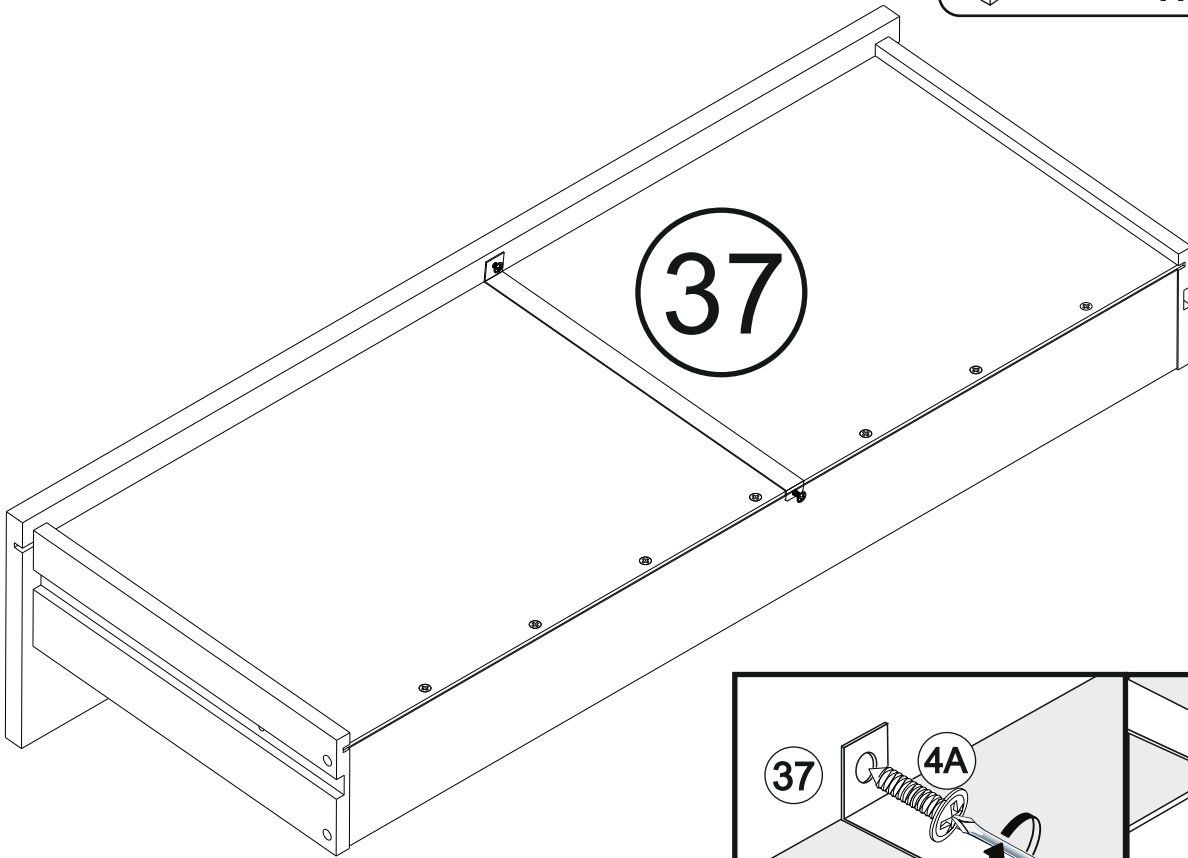
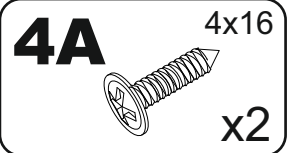

14

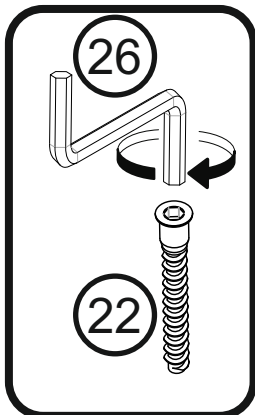
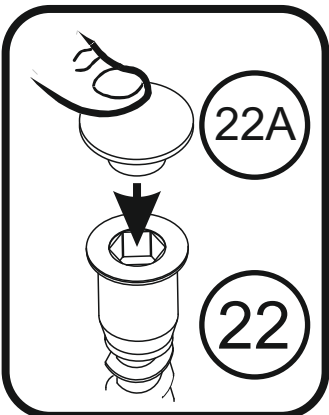
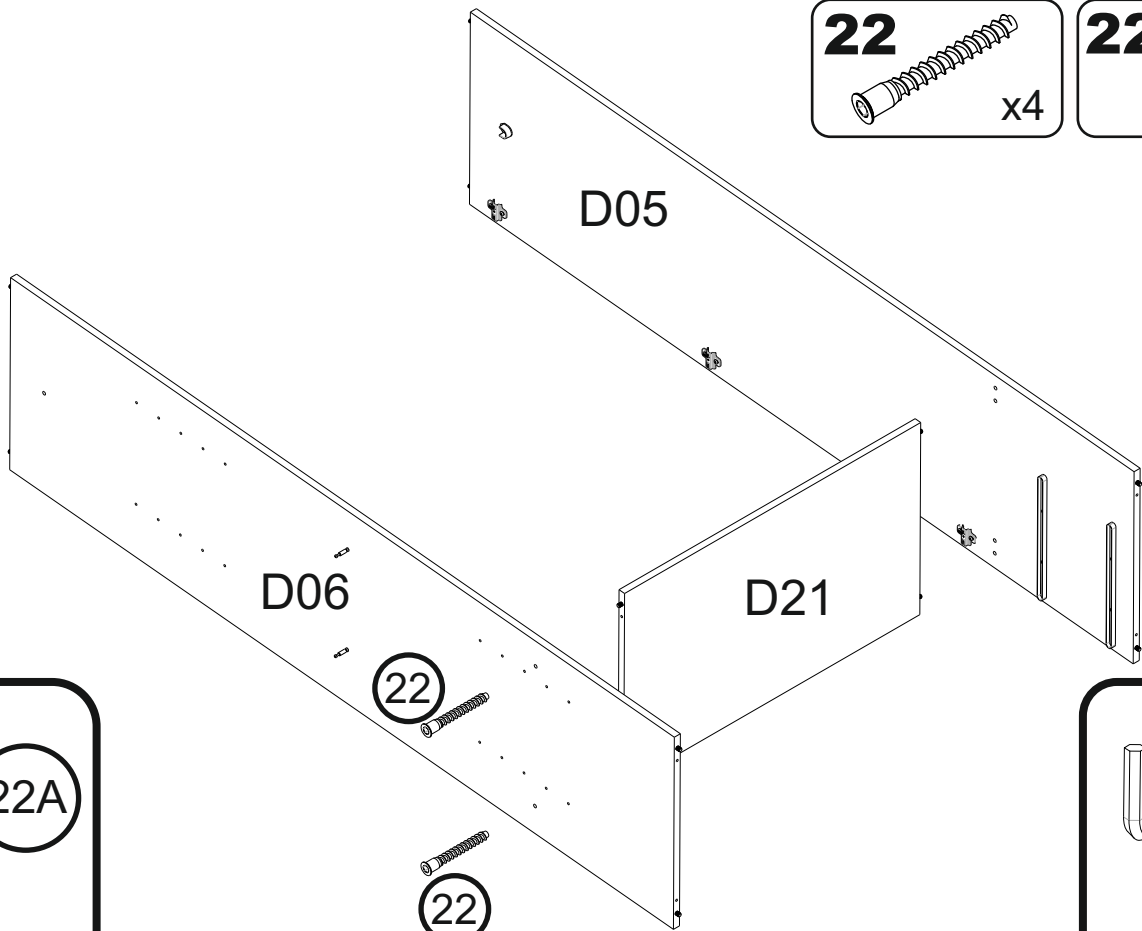
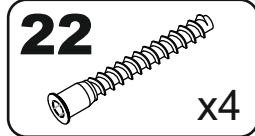

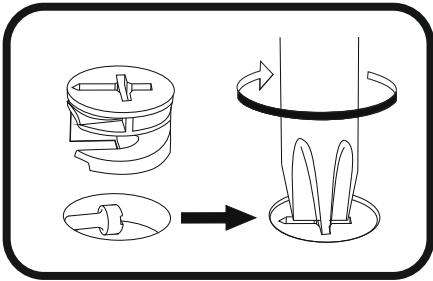
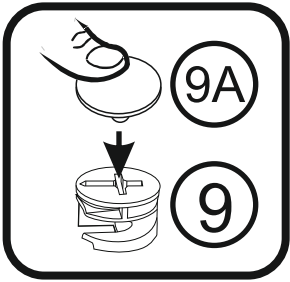
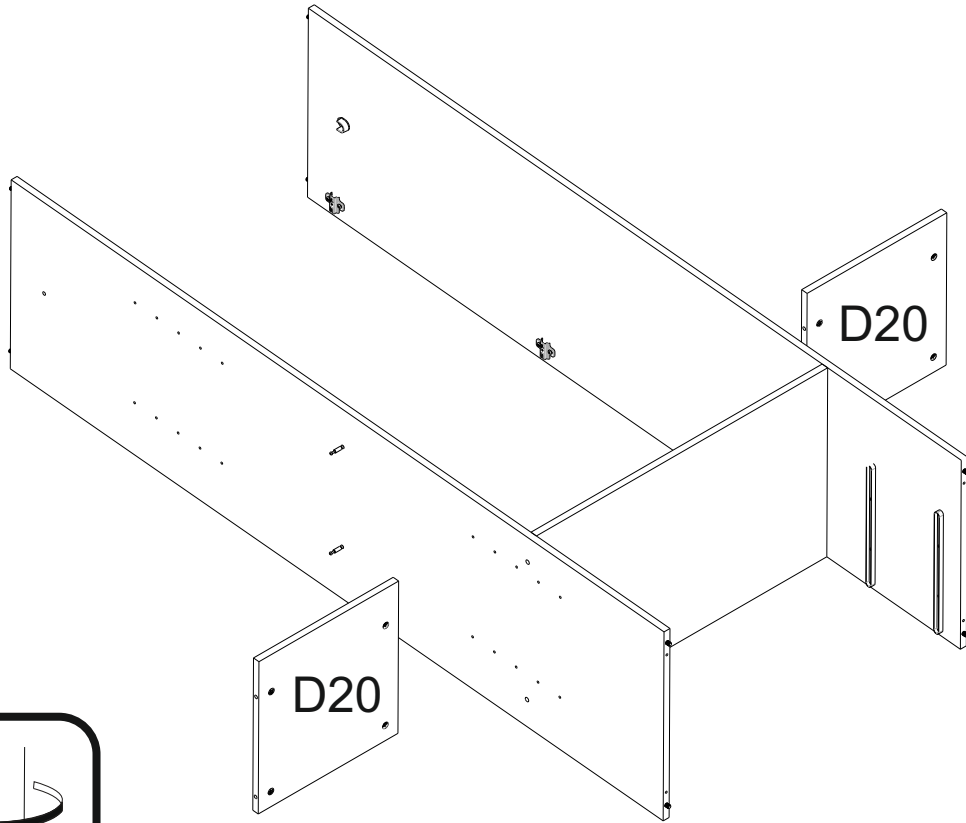

15 OPTION 'B'

9A  x4



16

9A  x4

22  x8

22A  x8

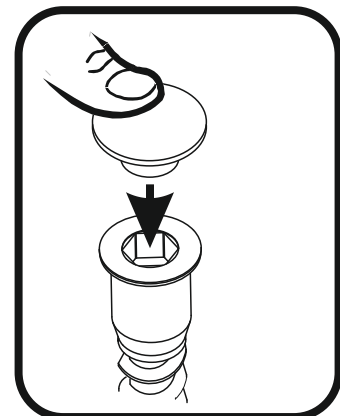
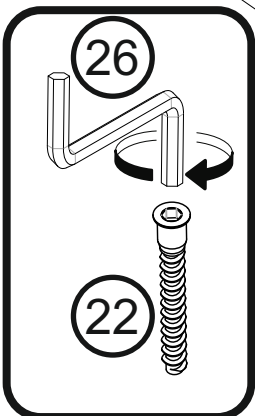
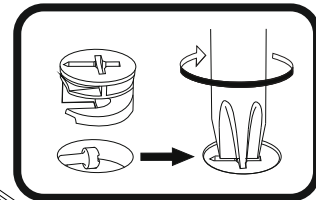
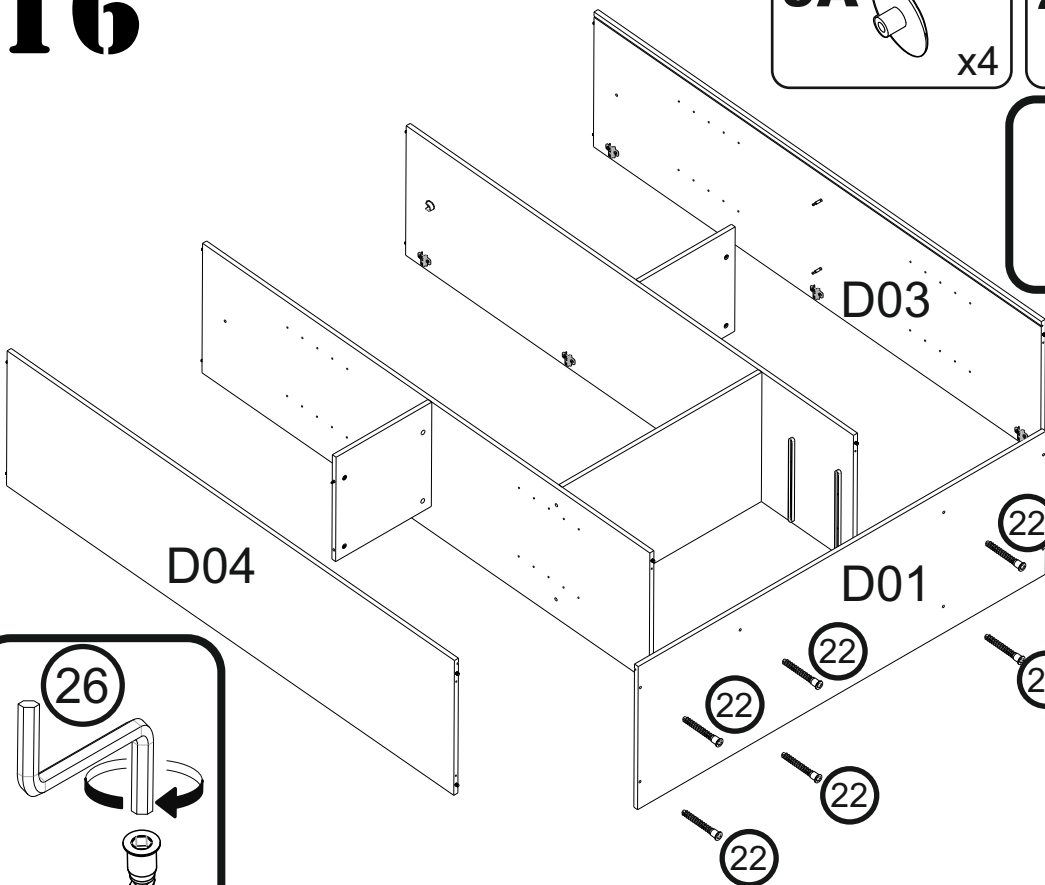

17 OPTION 'B'

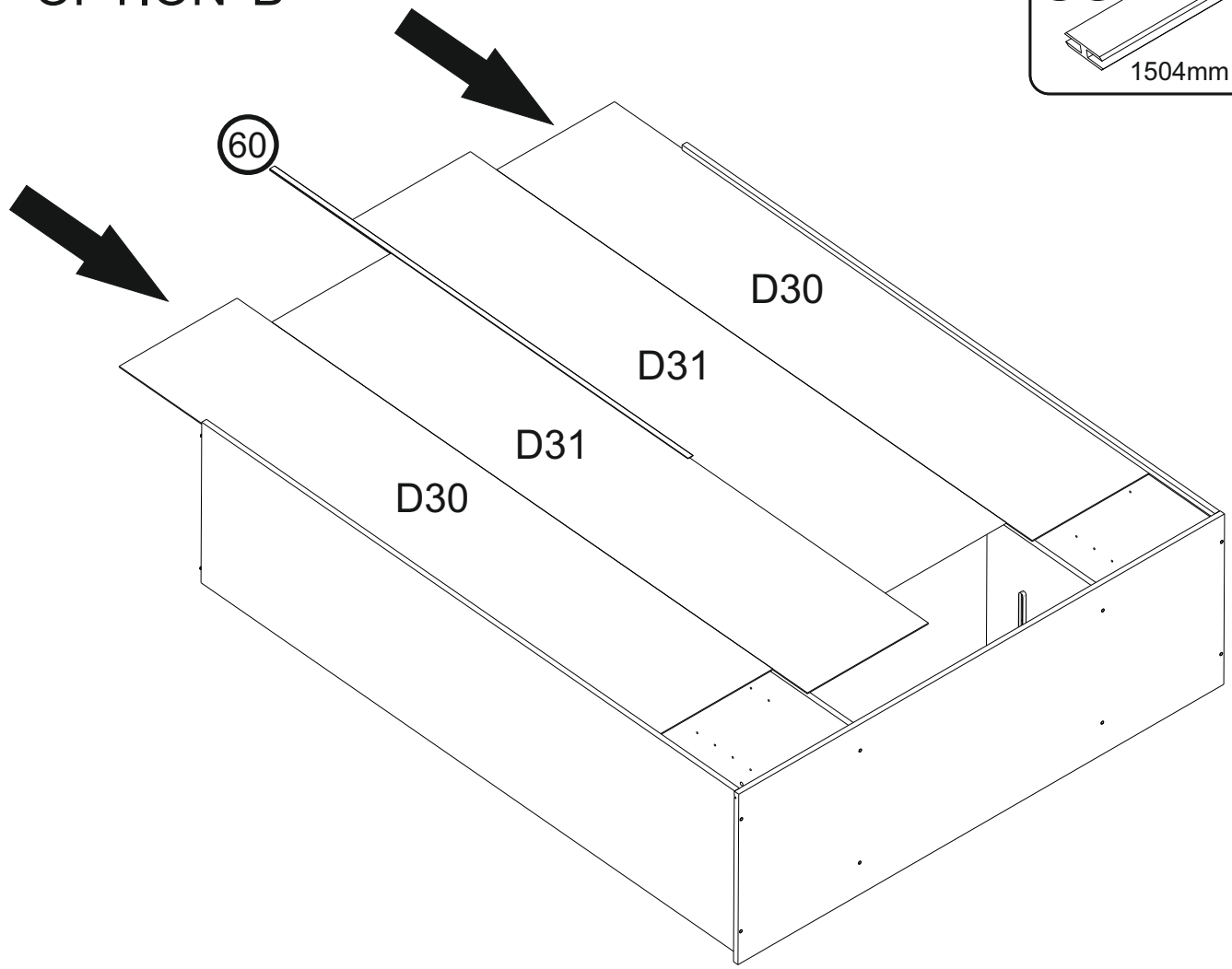
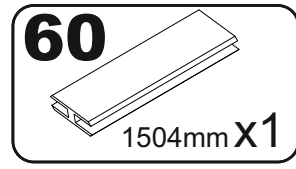

18

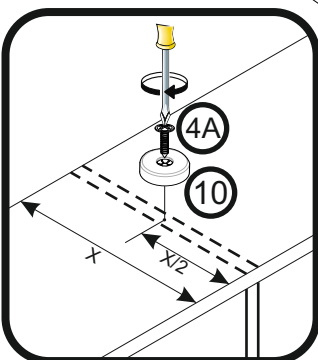
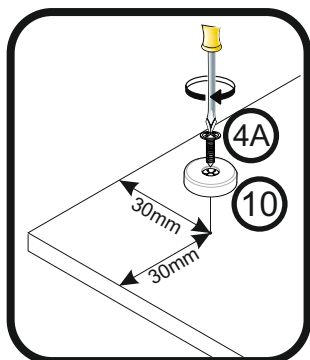
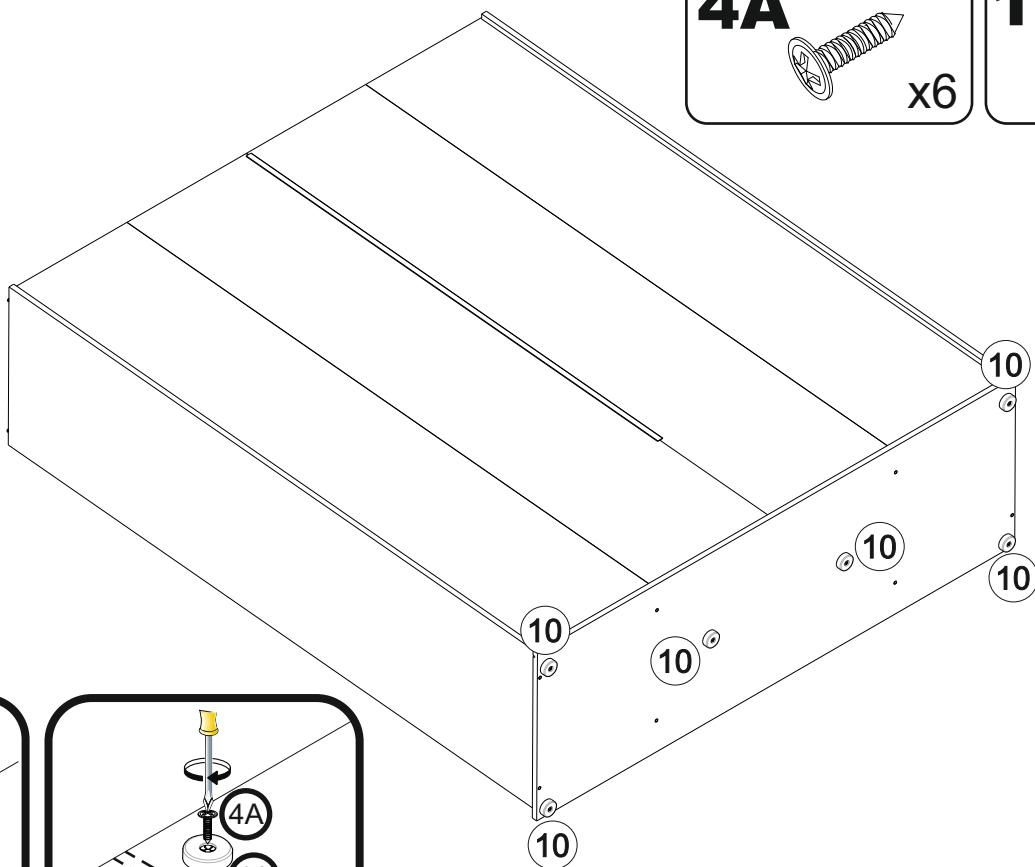
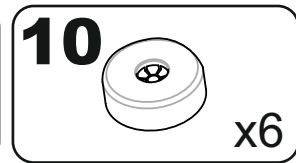
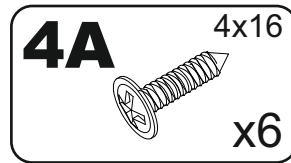

19 OPTION 'B'

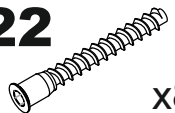
22  x8

22A  x8

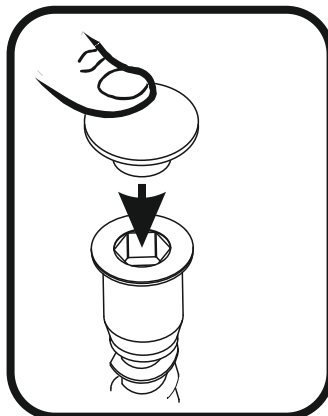
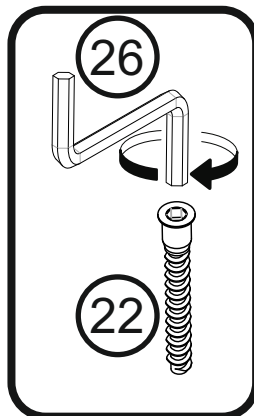
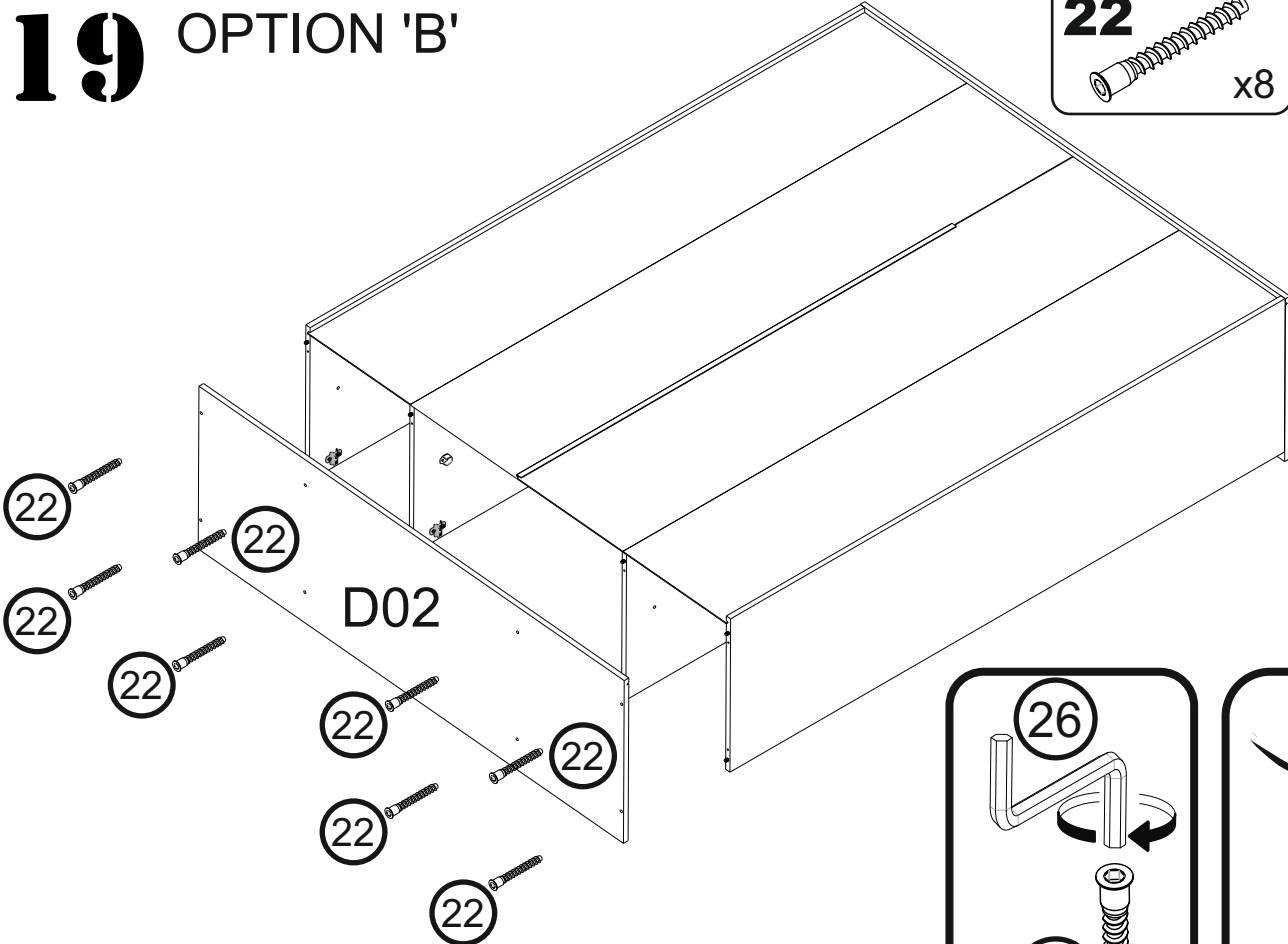

20

A=B

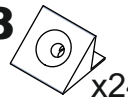
38  x24

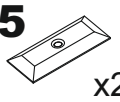
35  x24

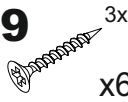
39  3x20 x64

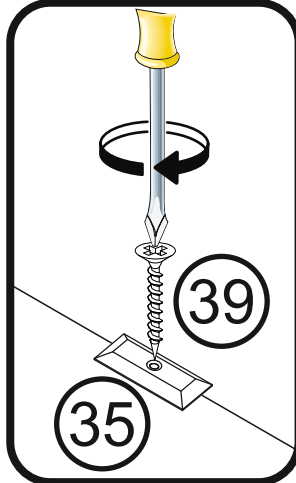
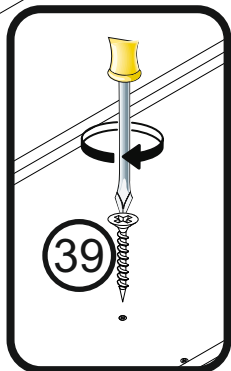
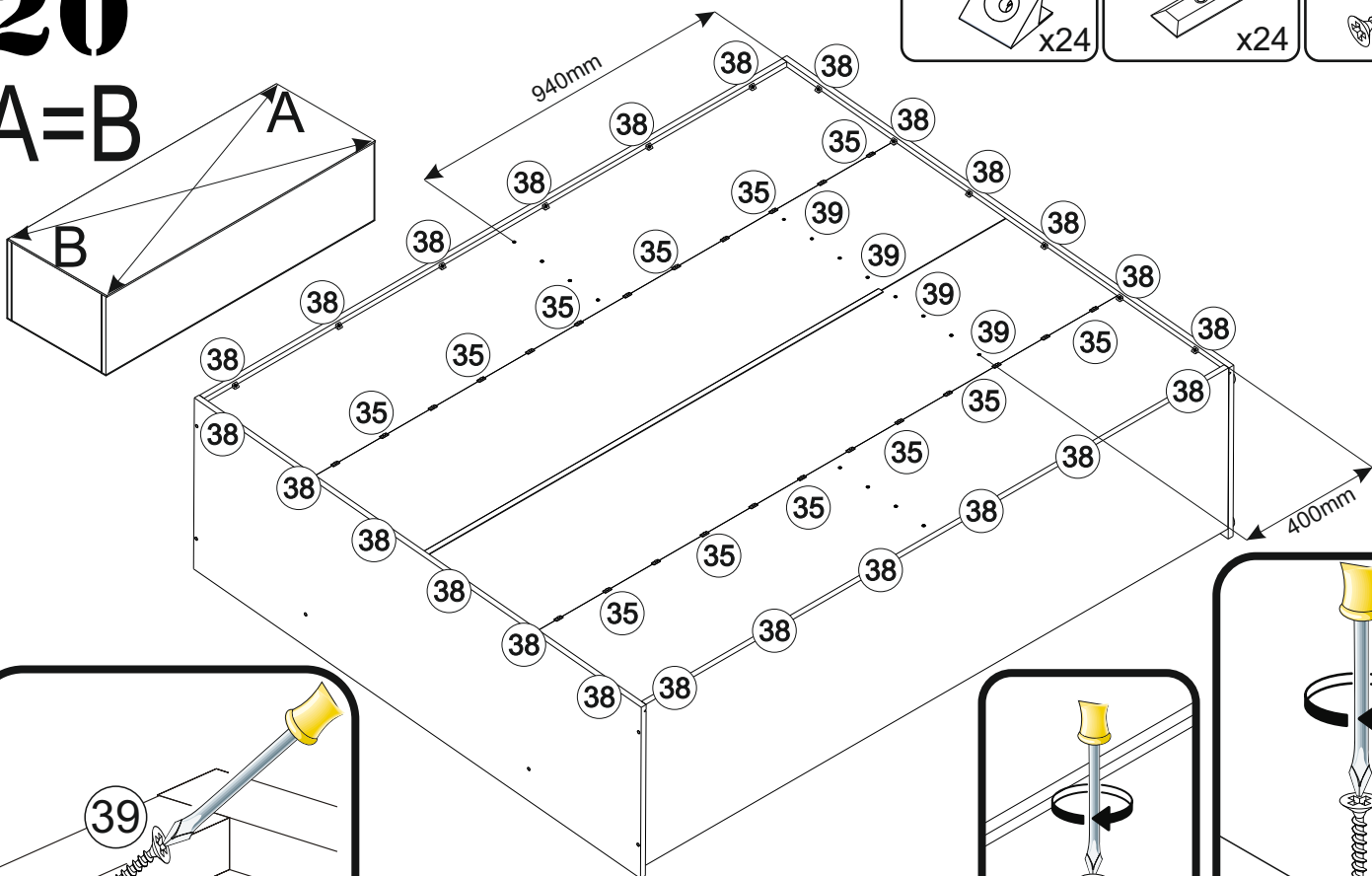

21 OPTION 'B'

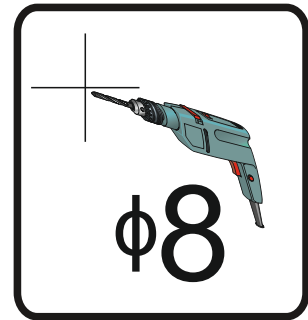
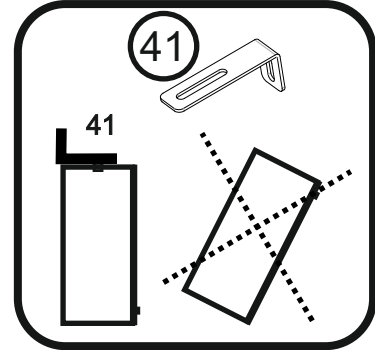
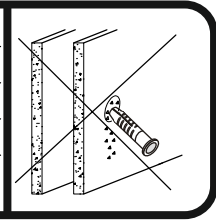
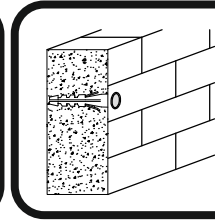
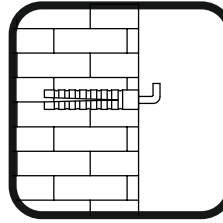
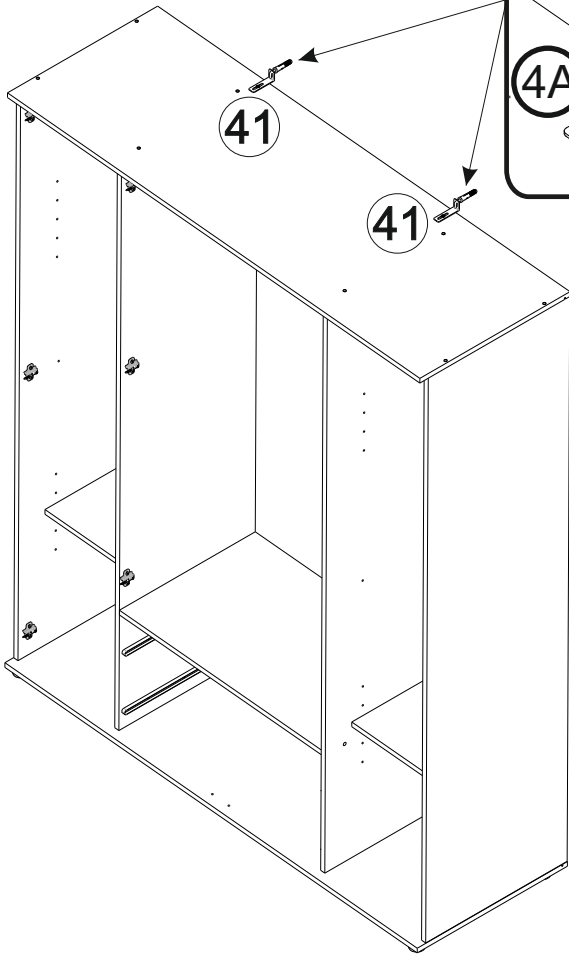
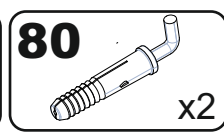
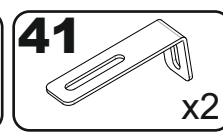
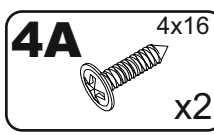
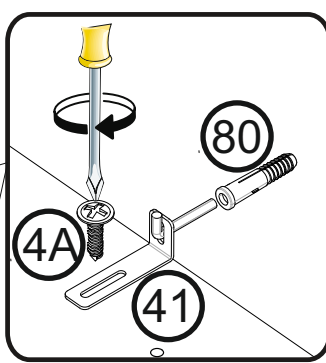

22

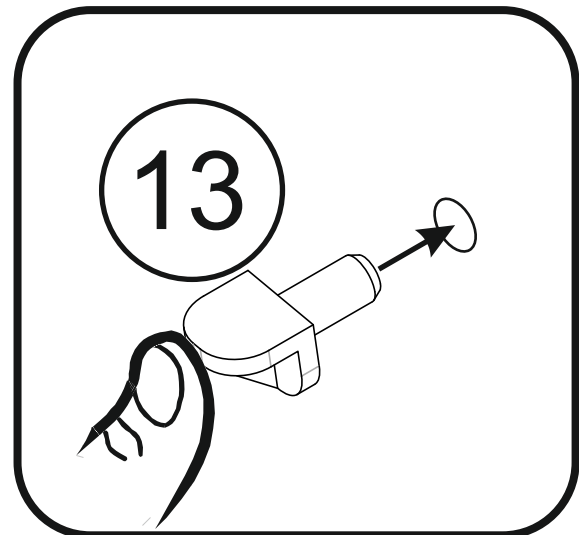
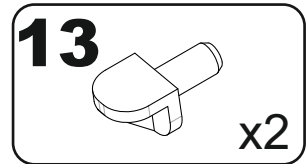
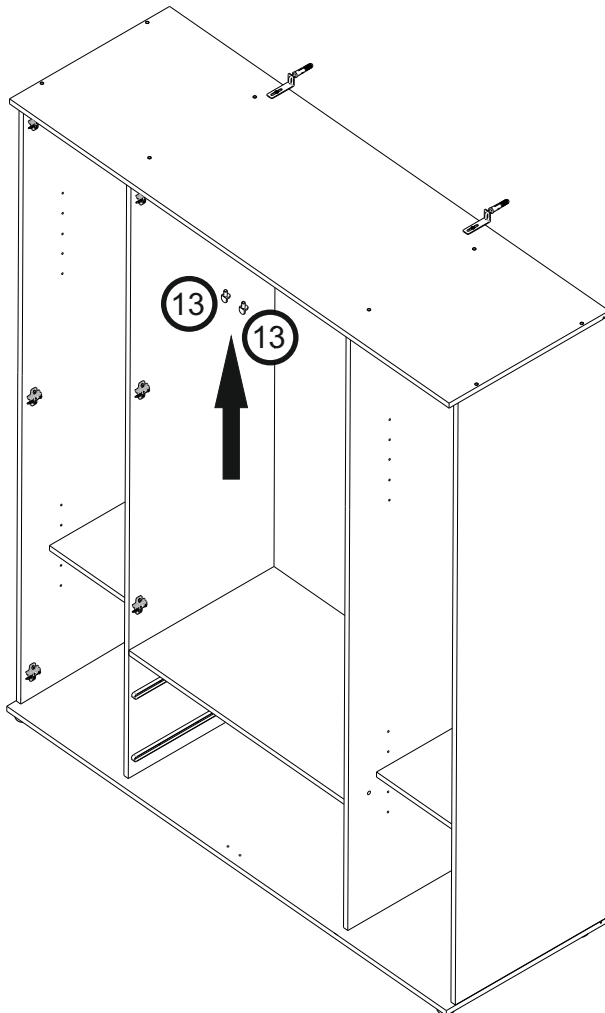

23 OPTION 'B'

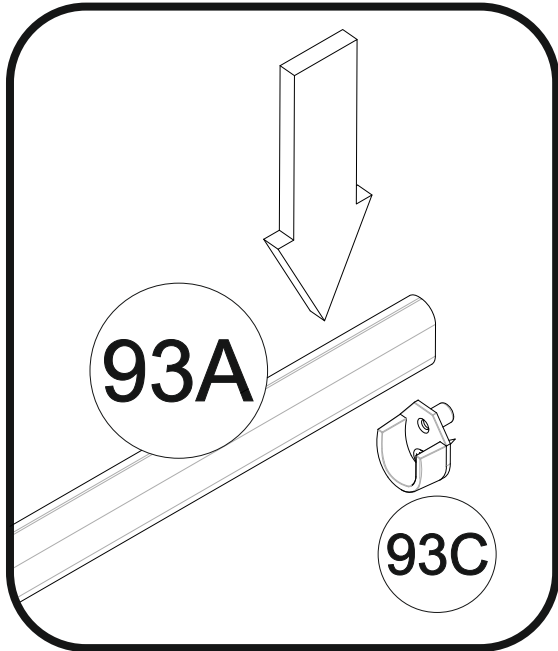
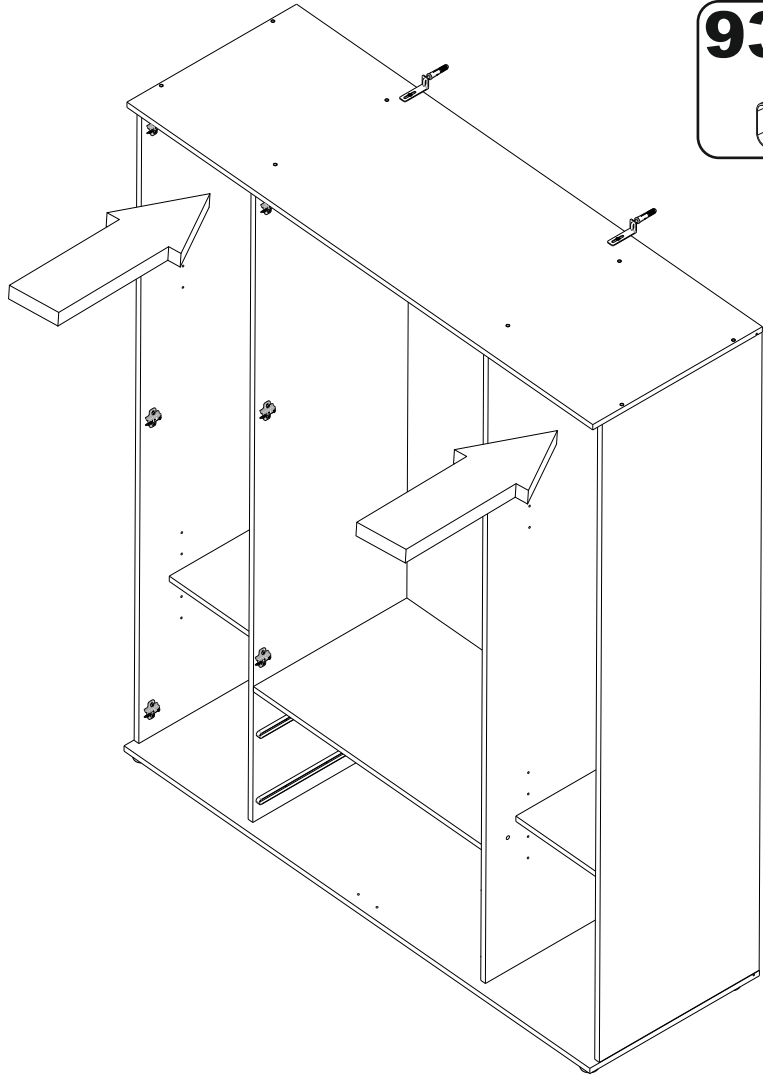
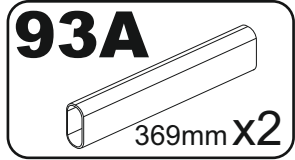

24

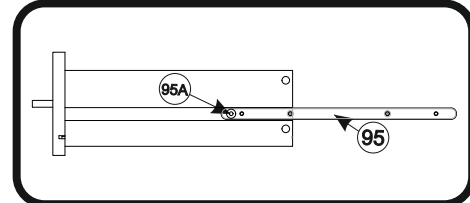
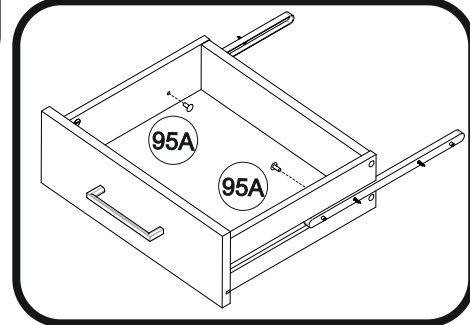
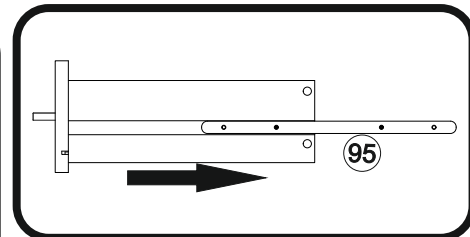
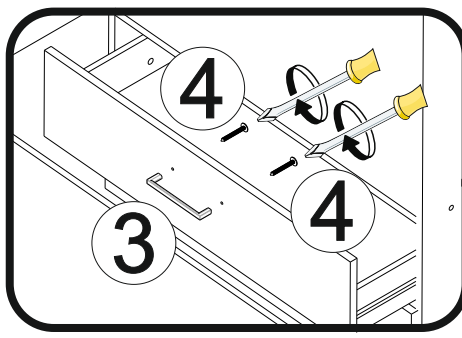
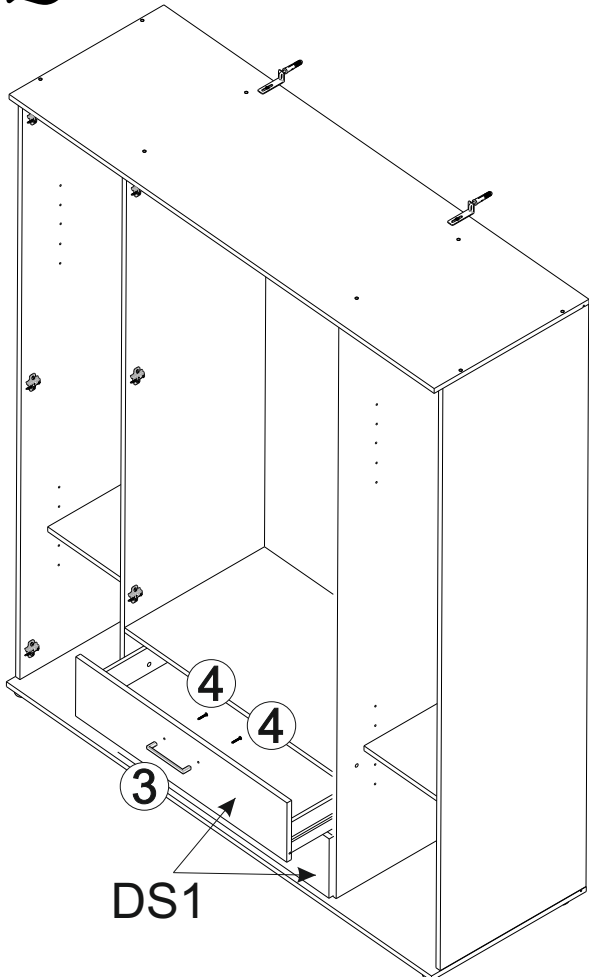
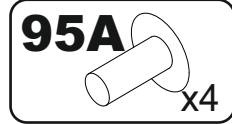
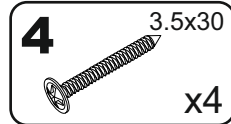
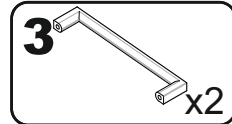

25 OPTION 'B'

