

little tikes

little tikes.com

- Cut, trim, sink
- Heavy duty
- 24" x 36" size
- 1 Year warranty
- Driveway & more
- Reposition 360°
- Strong handles
- Heavy duty
- 24" x 36" size
- 1 Year warranty
- Driveway & more
- Reposition 360°
- Strong handles



402K

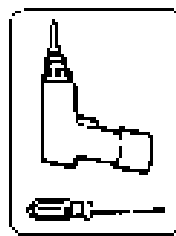

5-39

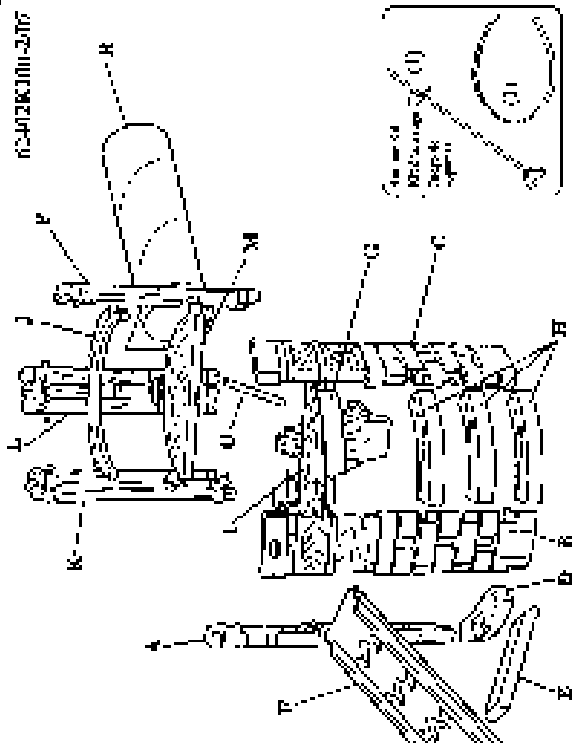

ENGLISH

SPIN & EXPLORE CULVER
ADULT ASSEMBLY INSTRUCTIONS

1. Lay out the front panel (A) and backrest (B) on a flat surface. Make sure the front panel (A) and backrest (B) are facing the same direction.
2. Insert the front panel (A) into the backrest (B) and secure the front panel (A) to the backrest (B) with the front panel (A) screws (C).
3. Insert the front panel (A) into the backrest (B) and secure the front panel (A) to the backrest (B) with the front panel (A) screws (C).
4. Insert the front panel (A) into the backrest (B) and secure the front panel (A) to the backrest (B) with the front panel (A) screws (C).
5. Insert the front panel (A) into the backrest (B) and secure the front panel (A) to the backrest (B) with the front panel (A) screws (C).
6. Insert the front panel (A) into the backrest (B) and secure the front panel (A) to the backrest (B) with the front panel (A) screws (C).
7. Insert the front panel (A) into the backrest (B) and secure the front panel (A) to the backrest (B) with the front panel (A) screws (C).
8. Insert the front panel (A) into the backrest (B) and secure the front panel (A) to the backrest (B) with the front panel (A) screws (C).
9. Insert the front panel (A) into the backrest (B) and secure the front panel (A) to the backrest (B) with the front panel (A) screws (C).
10. Insert the front panel (A) into the backrest (B) and secure the front panel (A) to the backrest (B) with the front panel (A) screws (C).

11. Insert the front panel (A) into the backrest (B) and secure the front panel (A) to the backrest (B) with the front panel (A) screws (C).
12. Insert the front panel (A) into the backrest (B) and secure the front panel (A) to the backrest (B) with the front panel (A) screws (C).
13. Insert the front panel (A) into the backrest (B) and secure the front panel (A) to the backrest (B) with the front panel (A) screws (C).
14. Insert the front panel (A) into the backrest (B) and secure the front panel (A) to the backrest (B) with the front panel (A) screws (C).
15. Insert the front panel (A) into the backrest (B) and secure the front panel (A) to the backrest (B) with the front panel (A) screws (C).
16. Insert the front panel (A) into the backrest (B) and secure the front panel (A) to the backrest (B) with the front panel (A) screws (C).
17. Insert the front panel (A) into the backrest (B) and secure the front panel (A) to the backrest (B) with the front panel (A) screws (C).
18. Insert the front panel (A) into the backrest (B) and secure the front panel (A) to the backrest (B) with the front panel (A) screws (C).
19. Insert the front panel (A) into the backrest (B) and secure the front panel (A) to the backrest (B) with the front panel (A) screws (C).
20. Insert the front panel (A) into the backrest (B) and secure the front panel (A) to the backrest (B) with the front panel (A) screws (C).

21. Insert the front panel (A) into the backrest (B) and secure the front panel (A) to the backrest (B) with the front panel (A) screws (C).
22. Insert the front panel (A) into the backrest (B) and secure the front panel (A) to the backrest (B) with the front panel (A) screws (C).
23. Insert the front panel (A) into the backrest (B) and secure the front panel (A) to the backrest (B) with the front panel (A) screws (C).
24. Insert the front panel (A) into the backrest (B) and secure the front panel (A) to the backrest (B) with the front panel (A) screws (C).
25. Insert the front panel (A) into the backrest (B) and secure the front panel (A) to the backrest (B) with the front panel (A) screws (C).
26. Insert the front panel (A) into the backrest (B) and secure the front panel (A) to the backrest (B) with the front panel (A) screws (C).
27. Insert the front panel (A) into the backrest (B) and secure the front panel (A) to the backrest (B) with the front panel (A) screws (C).
28. Insert the front panel (A) into the backrest (B) and secure the front panel (A) to the backrest (B) with the front panel (A) screws (C).
29. Insert the front panel (A) into the backrest (B) and secure the front panel (A) to the backrest (B) with the front panel (A) screws (C).
30. Insert the front panel (A) into the backrest (B) and secure the front panel (A) to the backrest (B) with the front panel (A) screws (C).

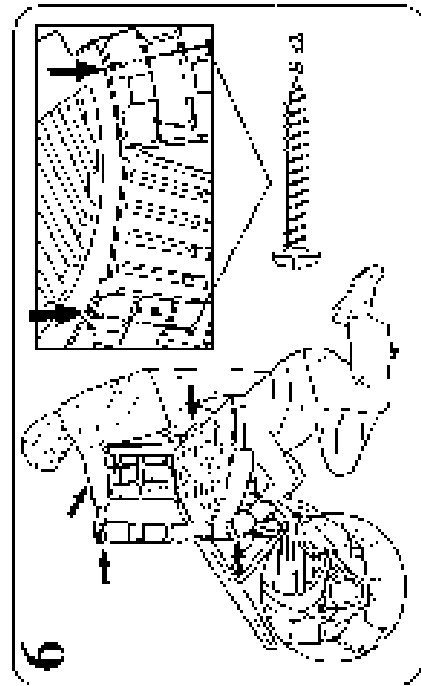
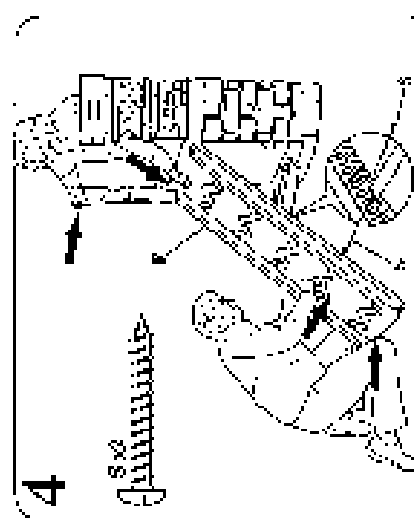
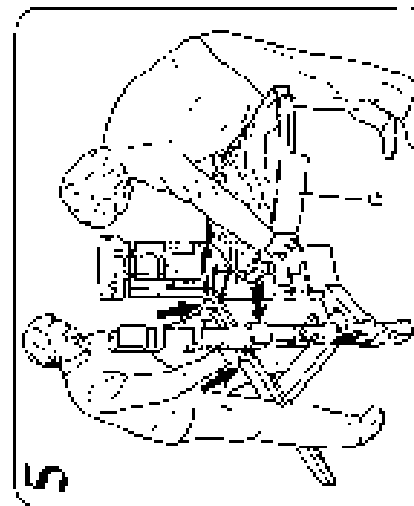
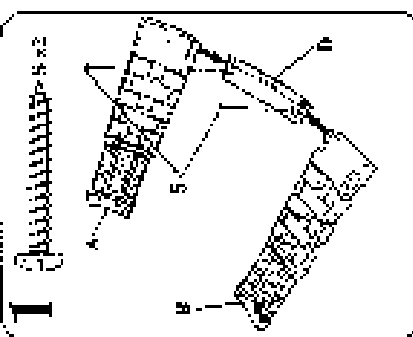
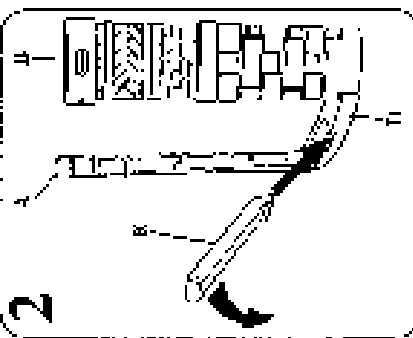
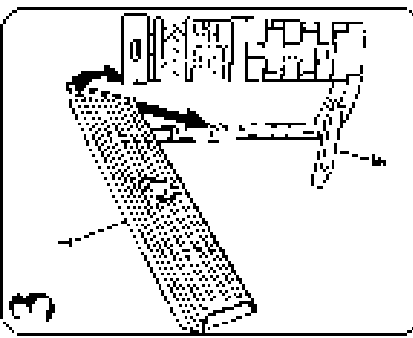

CE

LIMITED WARRANTY
This product is warranted against defects in materials and workmanship for a period of 1 year from the date of purchase. This warranty is void if the product is used for any purpose other than that intended. The manufacturer is not responsible for any damage to the product caused by misuse, neglect, or accidents. For more information, please contact the manufacturer at the address below.

