

**SAMSUNG**

SM-A310F  
SM-A310F/DS  
SM-A310Y

# User Manual

# Table of Contents

## Basics

- 4 Read me first
- 5 Package contents
- 6 Device layout
- 8 Battery
- 11 SIM or USIM card
- 16 Memory card
- 18 Turning the device on and off
- 19 Touchscreen
- 22 Home screen
- 28 Lock screen
- 29 Notification panel
- 31 Entering text
- 33 Screen capture
- 33 Opening apps
- 33 Transferring data from your previous device
- 35 Device and data management
- 38 Sharing files with contacts
- 39 Emergency mode

## Applications

- 40 Installing or uninstalling apps
- 41 Phone
- 46 Contacts
- 48 Messages
- 51 Internet

- 52 Email
- 53 Camera
- 61 Gallery
- 63 Smart Manager
- 65 S Planner
- 66 S Voice
- 68 Music
- 69 Video
- 70 Voice Recorder
- 71 My Files
- 72 Memo
- 72 Clock
- 74 Calculator
- 75 Radio
- 76 Google apps

## Settings

- 78 Introduction
- 78 Wi-Fi
- 80 Bluetooth
- 82 Flight mode
- 82 Mobile hotspot and tethering
- 83 Data usage
- 84 SIM card manager (dual SIM models)
- 85 Mobile networks
- 85 NFC and payment
- 88 More connection settings
- 90 Applications

91	Sounds and vibrations
91	Display
92	Advanced features
92	Wallpaper
93	Themes
93	Lock screen and security
94	Privacy and safety
95	Easy mode
96	Accessibility
97	Accounts
98	Backup and reset
98	Language and input
99	Battery
99	Storage
100	Date and time
100	User manual
100	About device

## Appendix

101	Troubleshooting
107	Removing the battery

# Basics

## Read me first

Please read this manual before using the device to ensure safe and proper use.

- Descriptions are based on the device's default settings.
- Some content may differ from your device depending on the region, service provider, model specifications, or device's software.
- Content (high quality content) that requires high CPU and RAM usage will affect the overall performance of the device. Apps related to the content may not work properly depending on the device's specifications and the environment that it is used in.
- Samsung is not liable for performance issues caused by apps supplied by providers other than Samsung.
- Samsung is not liable for performance issues or incompatibilities caused by edited registry settings or modified operating system software. Attempting to customise the operating system may cause the device or apps to work improperly.
- Software, sound sources, wallpapers, images, and other media provided with this device are licensed for limited use. Extracting and using these materials for commercial or other purposes is an infringement of copyright laws. Users are entirely responsible for illegal use of media.
- You may incur additional charges for data services, such as messaging, uploading and downloading, auto-syncing, or using location services depending on your data plan. For large data transfers, it is recommended to use the Wi-Fi feature.
- Default apps that come with the device are subject to updates and may no longer be supported without prior notice. If you have questions about an app provided with the device, contact a Samsung Service Centre. For user-installed apps, contact service providers.
- Modifying the device's operating system or installing softwares from unofficial sources may result in device malfunctions and data corruption or loss. These actions are violations of your Samsung licence agreement and will void your warranty.

- Depending on the region or model, some devices are required to receive approval from the Federal Communications Commission (FCC). If your device is approved by the FCC, you can view the FCC ID of the device. To view the FCC ID, tap **Apps** → **Settings** → **About device** → **Battery info**.
- Depending on the region, you can view the regulatory information on the device. To view the information, tap **Apps** → **Settings** → **About device** → **Regulatory information**.

## Instructional icons



**Warning:** situations that could cause injury to yourself or others



**Caution:** situations that could cause damage to your device or other equipment



**Notice:** notes, usage tips, or additional information

## Package contents

Check the product box for the following items:

- Device
- Quick start guide



- The items supplied with the device and any available accessories may vary depending on the region or service provider.
- The supplied items are designed only for this device and may not be compatible with other devices.
- Appearances and specifications are subject to change without prior notice.
- You can purchase additional accessories from your local Samsung retailer. Make sure they are compatible with the device before purchase.
- Use only Samsung-approved accessories. Using unapproved accessories may cause the performance problems and malfunctions that are not covered by the warranty.
- Availability of all accessories is subject to change depending entirely on manufacturing companies. For more information about available accessories, refer to the Samsung website.



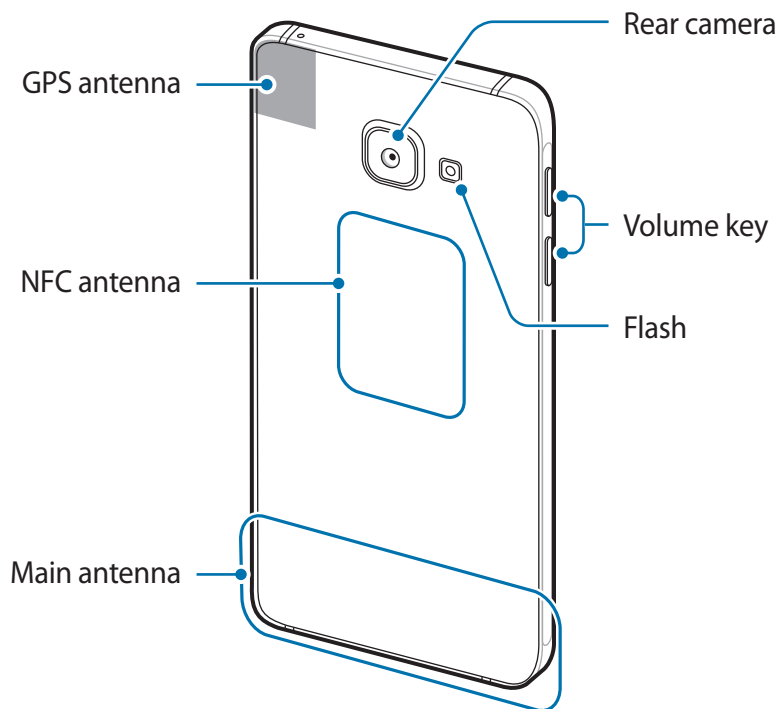
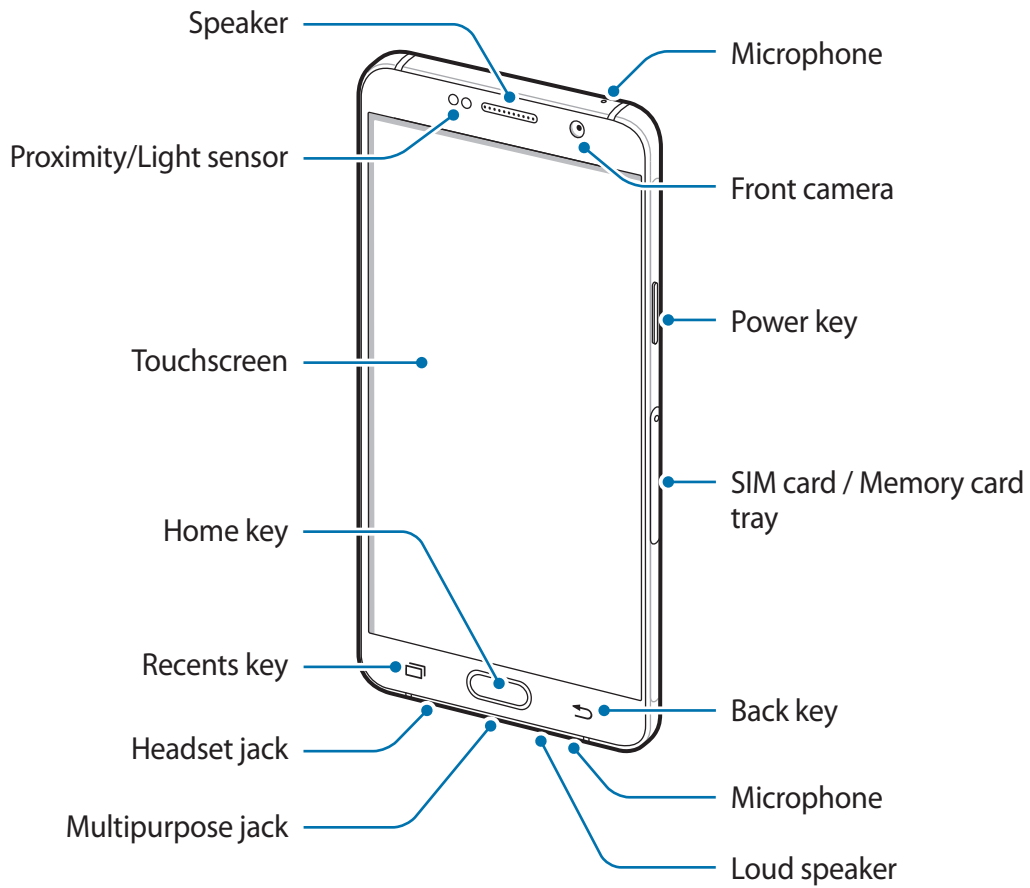

# Device layout





- Do not cover the antenna area with your hands or other objects. This may cause connectivity problems or drain the battery.
- Using a Samsung-approved screen protector is recommended. Unapproved screen protectors may cause the sensors to malfunction.
- Do not allow water to contact the touchscreen. The touchscreen may malfunction in humid conditions or when exposed to water.

## Keys

Key	Function
 <b>Power</b>	<ul style="list-style-type: none"> <li>• Press and hold to turn the device on or off.</li> <li>• Press to turn on or lock the screen.</li> </ul>
 <b>Recents</b>	<ul style="list-style-type: none"> <li>• Tap to open the list of recent apps.</li> </ul>
 <b>Home</b>	<ul style="list-style-type: none"> <li>• Press to turn on the screen while the screen is locked.</li> <li>• Press to return to the Home screen.</li> <li>• Press and hold to launch <b>Google</b>.</li> </ul>
 <b>Back</b>	<ul style="list-style-type: none"> <li>• Tap to return to the previous screen.</li> </ul>
 <b>Volume</b>	<ul style="list-style-type: none"> <li>• Press to adjust the device volume.</li> </ul>

# Battery

## Charging the battery

Charge the battery before using it for the first time or when it has been unused for extended periods.



Use only Samsung-approved chargers, batteries, and cables. Unapproved chargers or cables can cause the battery to explode or damage the device.

- 1 Connect the USB cable to the USB power adaptor, and then plug the end of the USB cable into the multipurpose jack.

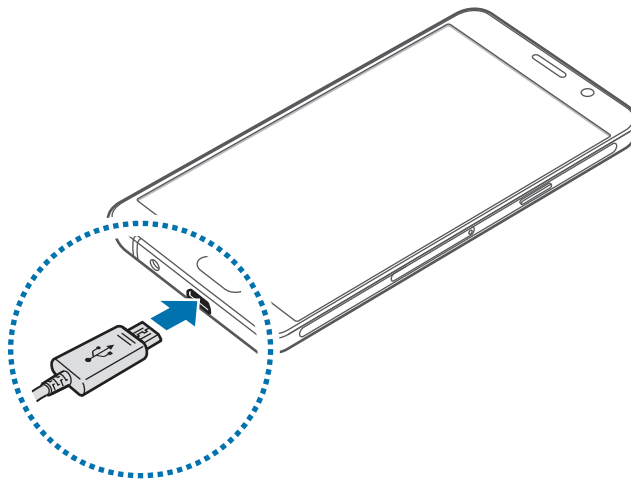

Connecting the charger improperly may cause serious damage to the device. Any damage caused by misuse is not covered by the warranty.

- 2 Plug the USB power adaptor into an electric socket.
- 3 After fully charging, disconnect the device from the charger. First unplug the charger from the device, and then unplug it from the electric socket.



To save energy, unplug the charger when not in use. The charger does not have a power switch, so you must unplug the charger from the electric socket when not in use to avoid wasting power. The charger should remain close to the electric socket and easily accessible while charging.



## Viewing the remaining charging time

While charging, open the Home screen and tap **Apps** → **Settings** → **Battery**.



The actual charging time may vary depending on the status of your device and the charging conditions. The remaining charging time may not be displayed when you charge the device in very cold or very hot conditions.

## Reducing the battery consumption

Your device provides various options that help you conserve battery power.

- Optimise the device using the Smart manager.
- When you are not using the device, switch to sleep mode by pressing the Power key.
- Activate power saving mode.
- Close unnecessary apps.
- Deactivate the Bluetooth feature when not in use.
- Deactivate the Wi-Fi feature when not in use.
- Deactivate auto-syncing of apps.
- Decrease the backlight time.
- Decrease the screen brightness.

## Battery charging tips and precautions

- When the battery power is low, the battery icon appears empty.
- If the battery is completely discharged, the device cannot be turned on immediately when the charger is connected. Allow a depleted battery to charge for a few minutes before turning on the device.
- If you use multiple apps at once, network apps, or apps that need a connection to another device, the battery will drain quickly. To avoid losing power during a data transfer, always use these apps after fully charging the battery.
- Using a power source other than the charger, such as a computer, may result in a slower charging speed due to a lower electric current.

- The device can be used while it is charging, but it may take longer to fully charge the battery.
- If the device receives an unstable power supply while charging, the touchscreen may not function. If this happens, unplug the charger from the device.
- While charging, the device and the charger may heat up. This is normal and should not affect the device's lifespan or performance. If the battery gets hotter than usual, the charger may stop charging.
- If the device is not charging properly, take the device and the charger to a Samsung Service Centre.

## Power saving mode

Save the battery power by limiting the device's functions.

On the Home screen, tap **Apps** → **Settings** → **Battery** → **Power saving mode**, and then tap the switch to activate it.

To automatically activate power saving mode when the remaining battery power reaches the preset level, tap **Start power saving** and select an option.

## Ultra power saving mode

Use this mode to extend the device's battery power. In ultra power saving mode, the device performs the following:

- Displays colours on the screen as grey tones.
- Restricts the available apps to essential and selected apps only.
- Deactivates the mobile data connection when the screen turns off.
- Deactivates the Wi-Fi and Bluetooth features.

On the Home screen, tap **Apps** → **Settings** → **Battery** → **Ultra power saving mode**, and then tap the switch to activate it.

To deactivate ultra power saving mode, tap **MORE** → **Disable Ultra power saving mode**.



The usage time left shows the time remaining before the battery power runs out. Usage time left may vary depending on your device settings and operating conditions.

## SIM or USIM card

### Installing the SIM or USIM card

Insert the SIM or USIM card provided by the mobile telephone service provider.



- Only nano-SIM cards work with the device.
- **Dual SIM models:** In some areas, data transfer speeds may be slower if two SIM cards are inserted in the device than when one SIM card is inserted.
- Some LTE services may not be available depending on the service provider. For more information about service availability, contact your service provider.

#### ► Single SIM models:

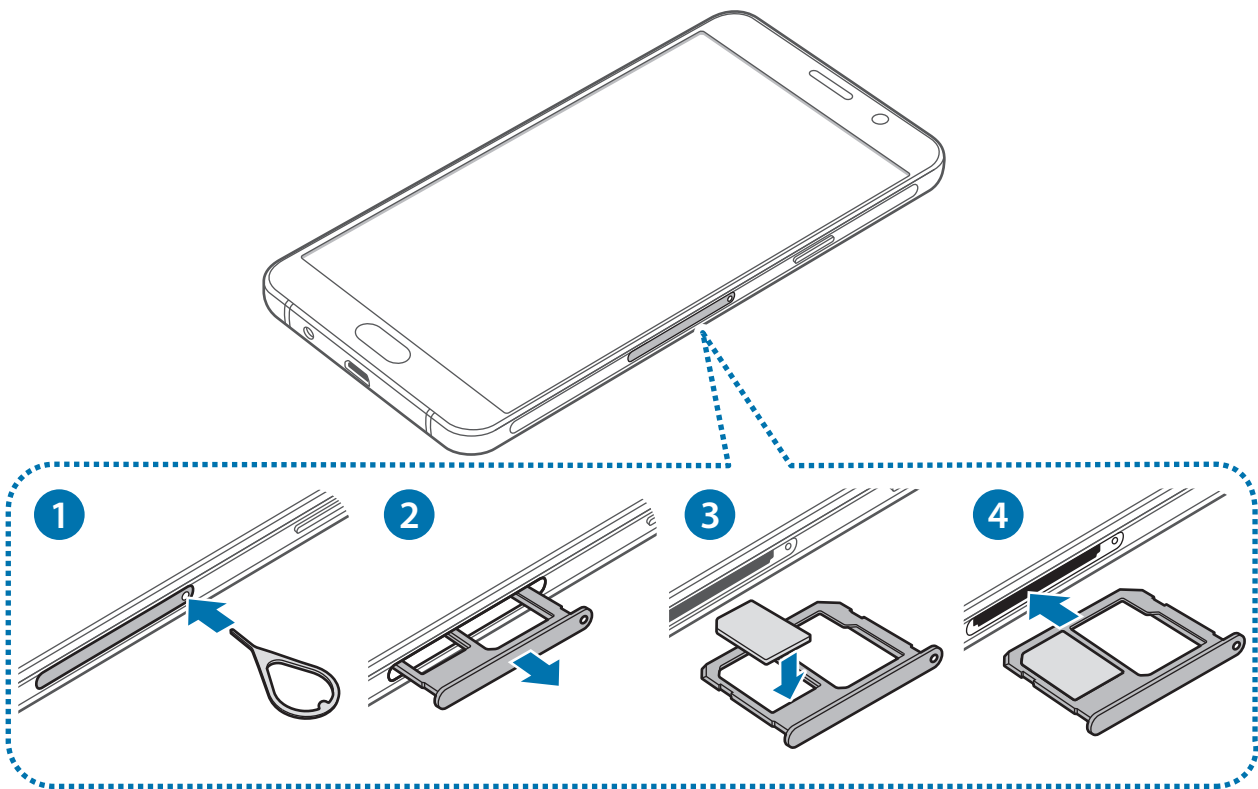

► Dual SIM models:

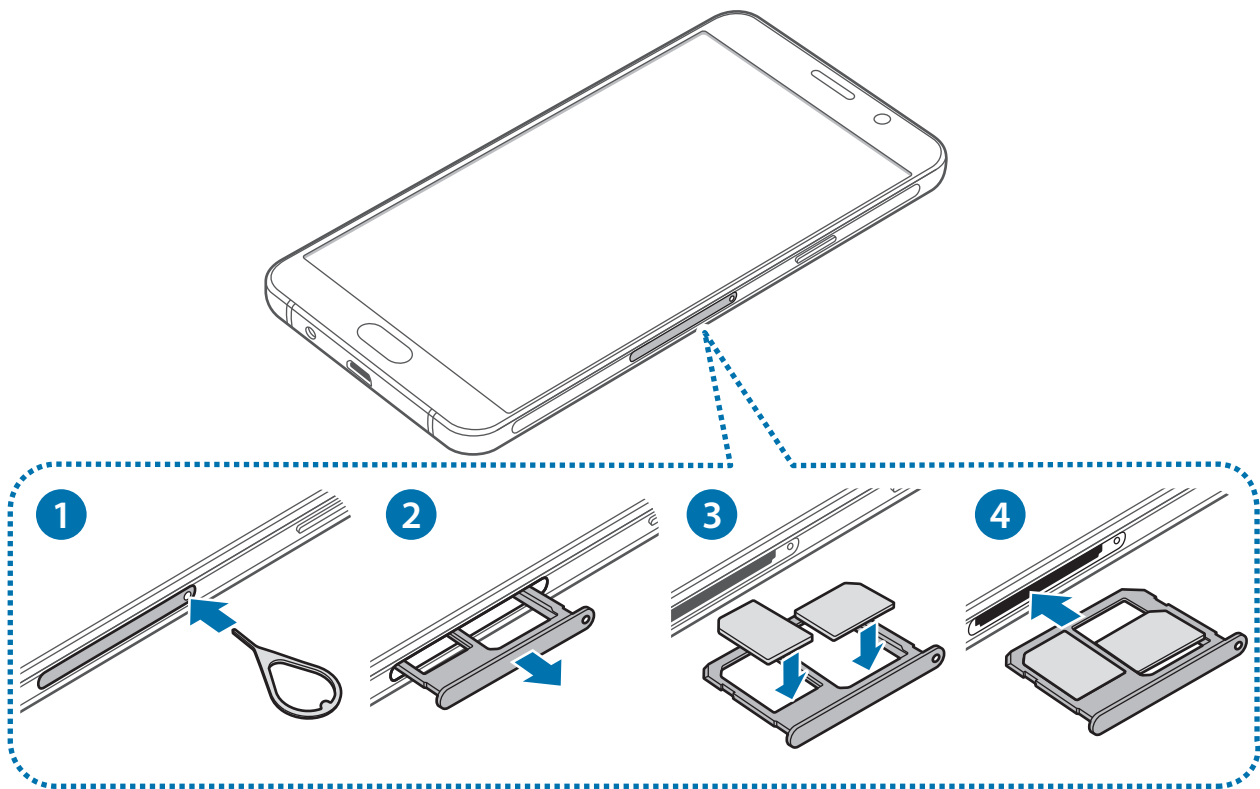

1 Insert the ejection pin into the hole on the SIM card tray to loosen the tray.

 Ensure that the ejection pin is perpendicular to the hole. Otherwise, the device may be damaged.

2 Pull out the SIM card tray gently from the SIM card tray slot.

**3** ▶ **Single SIM models:** Place the SIM or USIM card on the SIM card tray with the gold-coloured contacts facing downwards.

▶ **Dual SIM models:** Place the SIM or USIM card on the SIM card tray with the gold-coloured contacts facing downwards.

Place the primary SIM or USIM card on the SIM card tray 1 (1) and the secondary SIM or USIM card on the SIM card tray 2 (2).

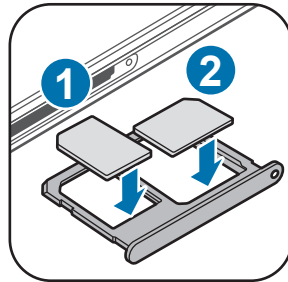

 Use caution not to lose or let others use the SIM or USIM card. Samsung is not responsible for any damages or inconveniences caused by lost or stolen cards.

 **Dual SIM models:** The SIM card tray 2 also serves as the memory card tray. However, you cannot place both the SIM or USIM card and the memory card at the same time.

**4** Insert the SIM card tray back into the SIM card tray slot.

 Carefully insert the SIM card tray to prevent the SIM cards from leaving or falling out of the tray.

## Removing the SIM or USIM card

- 1 Insert the ejection pin into the hole on the SIM card tray to loosen the tray.
- 2 Pull out the SIM card tray gently from the SIM card tray slot.
- 3 Remove the SIM or USIM card.

► **Single SIM models:**

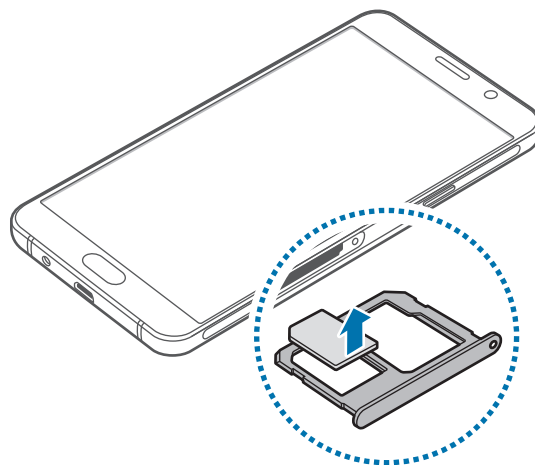

► **Dual SIM models:**

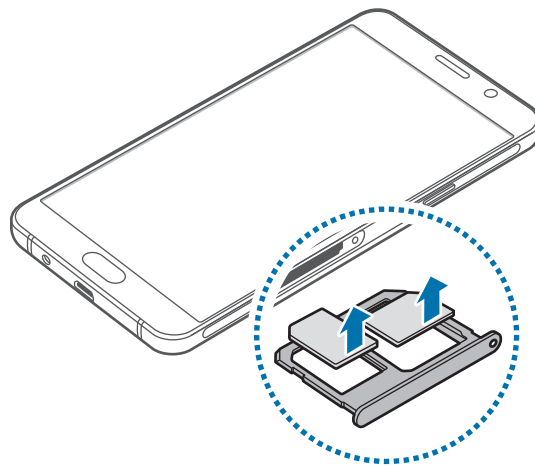

- 4 Insert the SIM card tray back into the SIM card tray slot.

## Using dual SIM or USIM cards (dual SIM models)

If you insert two SIM or USIM cards, you can have two phone numbers or service providers for a single device.

### Activating SIM or USIM cards

On the Home screen, tap **Apps** → **Settings** → **SIM card manager**. Select a SIM or USIM card and tap the switch to activate it.

### Changing the display name and icon of SIM or USIM cards

On the Home screen, tap **Apps** → **Settings** → **SIM card manager**. Select a SIM or USIM card, and tap **Name** or **Icon**. Set a display name and icon for each card.

### Setting preferred SIM or USIM cards

When two cards are activated, you can assign voice calls, messaging, and data services to specific cards.

On the Home screen, tap **Apps** → **Settings** → **SIM card manager** and set the feature preferences for your cards in **Preferred SIM card**.

# Memory card

## Installing a memory card

Your device accepts memory cards with maximum capacities of 128 GB. Depending on the memory card manufacturer and type, some memory cards may not be compatible with your device.



- Some memory cards may not be fully compatible with the device. Using an incompatible card may damage the device or the memory card, or corrupt the data stored in it.
- Use caution to insert the memory card right-side up.



- The device supports the FAT and the exFAT file systems for memory cards. When inserting a card formatted in a different file system, the device asks to reformat the memory card.
- Frequent writing and erasing of data shortens the lifespan of memory cards.
- When inserting a memory card into the device, the memory card's file directory appears in the **My Files** → **SD card** folder.

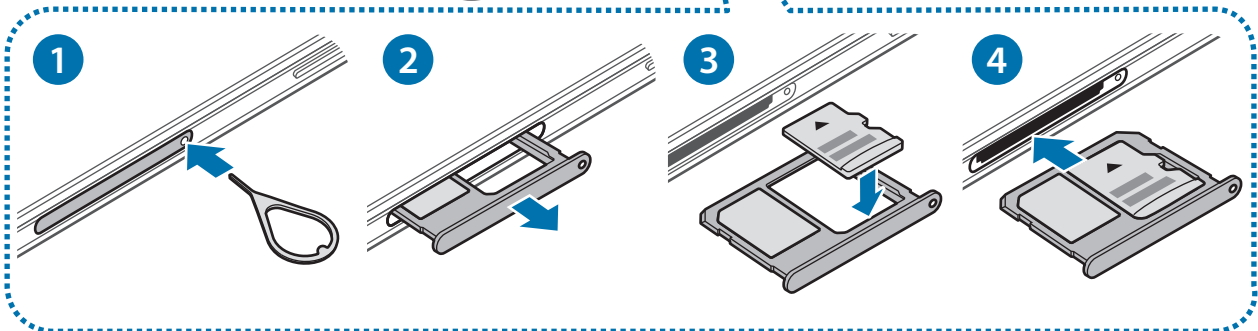
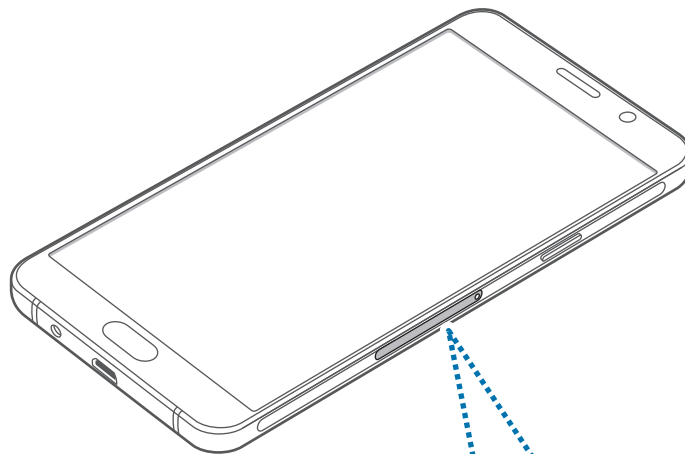



- 1 Insert the ejection pin into the hole on the memory card tray to loosen the tray.  
 Ensure that the ejection pin is perpendicular to the hole. Otherwise, the device may be damaged.
- 2 Pull out the memory card tray gently from the memory card tray slot.
- 3 Place a memory card on the memory card tray with the gold-coloured contacts facing downwards.
- 4 Insert the memory card tray back into the memory card tray slot.

## Removing the memory card

Before removing the memory card, first unmount it for safe removal.

On the Home screen, tap **Apps** → **Settings** → **Storage** → **SD card** → **Unmount**.

- 1 Insert the ejection pin into the hole on the memory card tray to loosen the tray.
  - 2 Pull out the memory card tray gently from the memory card tray slot.
  - 3 Remove the memory card.
  - 4 Insert the memory card tray back into the memory card tray slot.
-  Do not remove the memory card while the device is transferring or accessing information. Doing so can cause data to be lost or corrupted or damage to the memory card or device. Samsung is not responsible for losses that result from the misuse of damaged memory cards, including the loss of data.

## Formatting the memory card

A memory card formatted on a computer may not be compatible with the device. Format the memory card on the device.

On the Home screen, tap **Apps** → **Settings** → **Storage** → **SD card** → **Format** → **FORMAT**.



Before formatting the memory card, remember to make backup copies of all important data stored in the memory card. The manufacturer's warranty does not cover loss of data resulting from user actions.

## Turning the device on and off

Press and hold the Power key for a few seconds to turn on the device.

When you turn on your device for the first time or after performing a data reset, follow the on-screen instructions to set up your device.

To turn off the device, press and hold the Power key, and then tap **Power off**.



Follow all posted warnings and directions from authorised personnel in areas where the use of wireless devices is restricted, such as aeroplanes and hospitals.

## Restarting the device

If your device is frozen and unresponsive, press and hold the Power key and the Volume Down key simultaneously for more than 7 seconds to restart it.

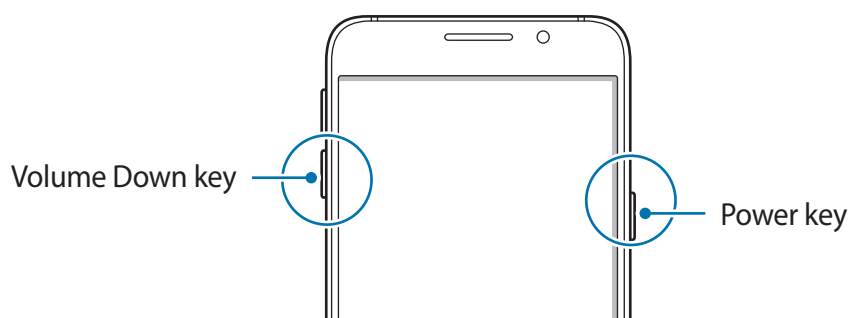

## Touchscreen



- Do not allow the touchscreen to come into contact with other electrical devices. Electrostatic discharges can cause the touchscreen to malfunction.
- To avoid damaging the touchscreen, do not tap it with anything sharp or apply excessive pressure to it with your fingertips.



- The device may not recognise touch inputs close to the edges of the screen, which are outside of the touch input area.
- Leaving the touchscreen idle for extended periods may result in afterimages (screen burn-in) or ghosting. Turn off the touchscreen when you do not use the device.
- It is recommended to use fingers when you use the touchscreen.

## Tapping

To open an app, to select a menu item, to press an on-screen button, or to enter a character using the keyboard on the screen, tap it with your finger.

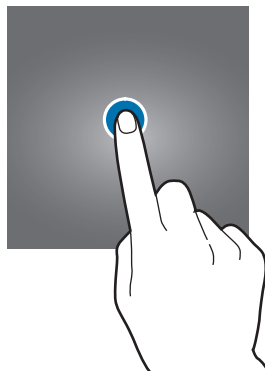

## Tapping and holding

Tap and hold an item or the screen for more than 2 seconds to access available options.

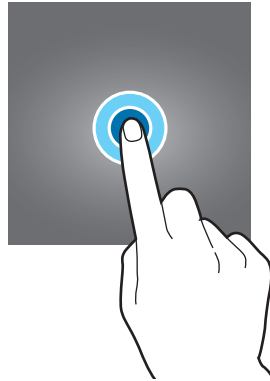

## Dragging

To move an item, tap and hold it and drag it to the target position.

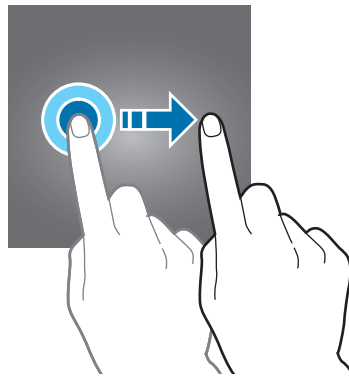

## Double-tapping

Double-tap on a webpage or image to zoom in. Double-tap again to return.

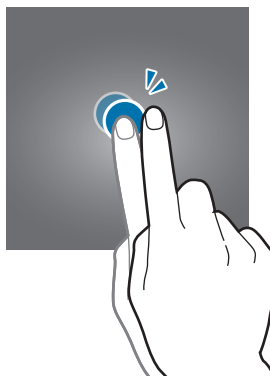

## Swiping

Swipe to the left or right on the Home screen or the Apps screen to view other panels. Swipe upwards or downwards to scroll through a webpage or a list of items, such as contacts.

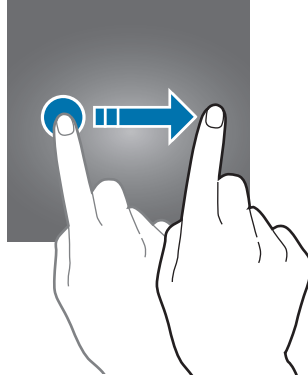

## Spreading and pinching

Spread two fingers apart on a webpage, map, or image to zoom in a part. Pinch to zoom out.

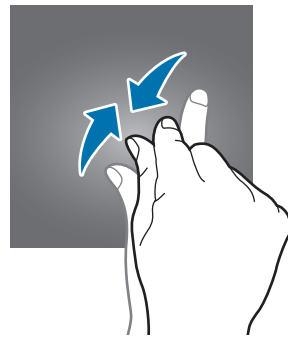
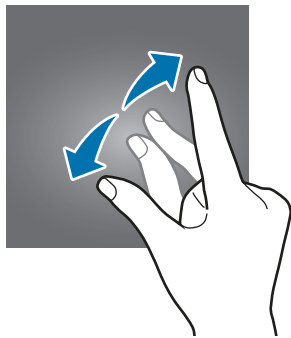

# Home screen

## Home screen

The Home screen is the starting point for accessing all of the device's features. It displays widgets, shortcuts to apps, and more.

To view other panels, swipe to the left or right.



The Home screen may appear differently depending on the region or service provider.

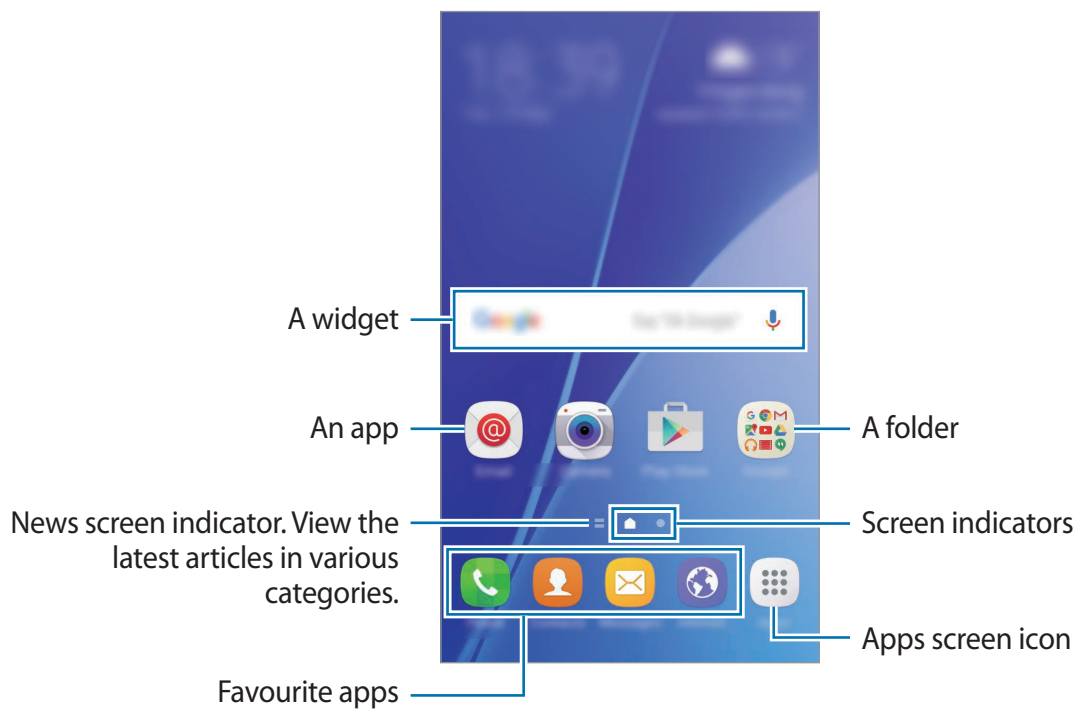

## Home screen options

On the Home screen, tap and hold an empty area, or pinch your fingers together to access the available options. Customise the Home screen by adding, deleting, or rearranging Home screen panels. You can also set the Home screen wallpaper, add widgets to the Home screen, and more.

- **Wallpapers:** Change the wallpaper settings for the Home screen and the locked screen.
- **Widgets:** Add widgets to the Home screen. Widgets are small apps that launch specific app functions to provide information and convenient access on your Home screen.
- **Themes:** Change the device's theme. Visual elements of interface, such as colours, icons, and wallpapers, will change depending on the selected theme.
- **Screen grid:** Change the size of the grid to display more or less items on the Home screen and the Apps screen.

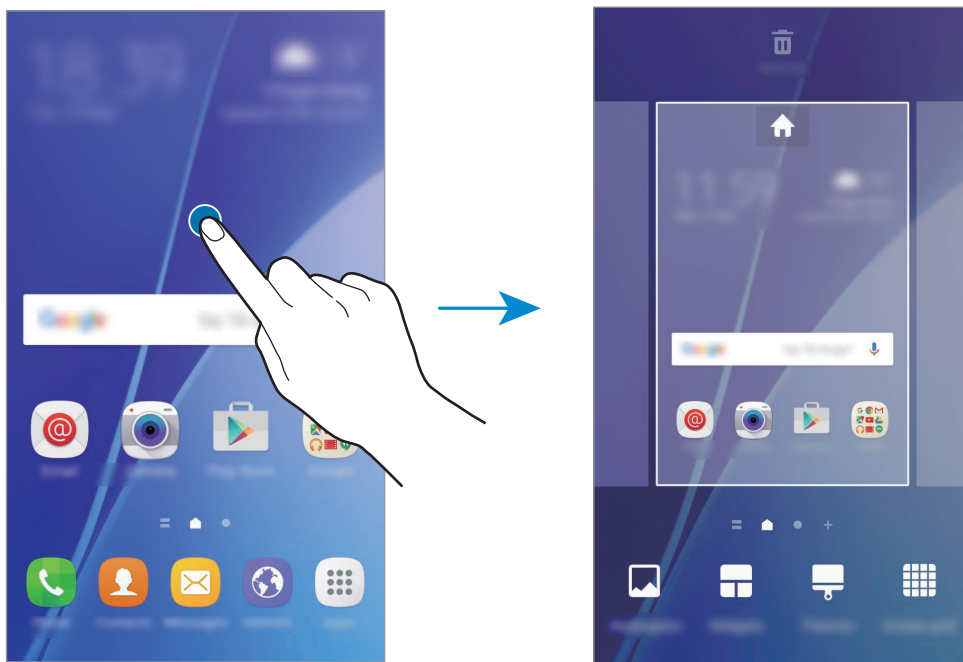

## Adding items

Tap and hold an app or a folder from the Apps screen, and then drag it to the Home screen. To add widgets, tap and hold an empty area on the Home screen, tap **Widgets**, tap and hold a widget, and then drag it to the Home screen.

## Moving and removing an item

Tap and hold an item on the Home screen, and then drag it to a new location.

To move the item to another panel, drag it to the side of the screen.

You can also move frequently used apps to the shortcuts area at the bottom of the Home screen.

To remove an item, tap and hold the item. Then, drag it to **Remove** at the top of the screen.

## Creating folders

1 On the Home screen, tap and hold an app, and then drag it over another app.

2 Drop the app when a folder frame appears around the apps.

A new folder containing the selected apps will be created.

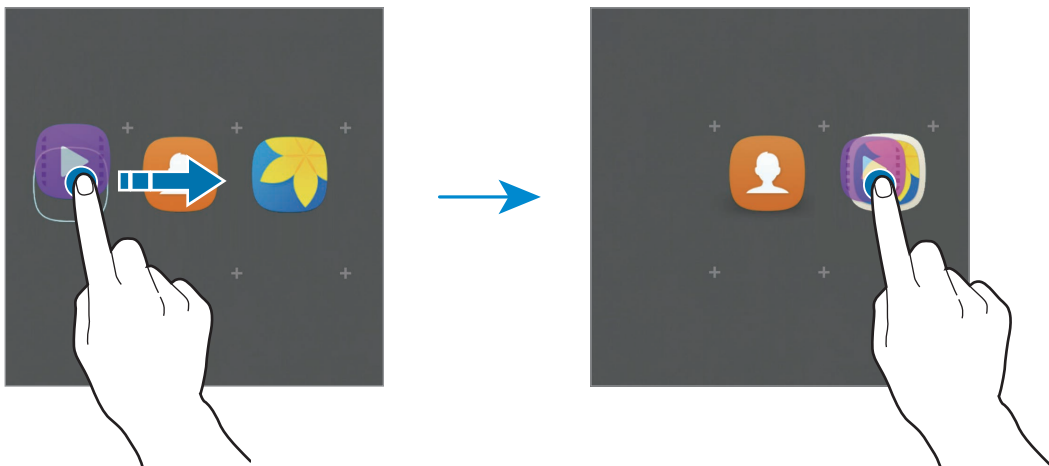

3 Tap **Enter folder name** and enter a folder name.

To change the folder colour, tap 🎨.

To add more apps to the folder, tap and hold another app, and then drag it to the folder.

To move apps from a folder to the Home screen, tap the folder, and then drag an app to the Home screen.

To delete apps in a folder, tap the folder, and then drag the app you want to delete to **Remove** at the top of the screen.



## Managing panels

On the Home screen, tap and hold an empty area to add, move, or remove a panel.

To add a panel, swipe to the left, and then tap **+**.

To move a panel, tap and hold a panel preview, and then drag it to a new location.

To remove a panel, tap and hold a panel preview, and then drag it to **Remove** at the top of the screen.

To set a panel as the main Home screen, tap .

## Apps screen

The Apps screen displays icons for all apps, including newly installed apps.

On the Home screen, tap **Apps** to open the Apps screen. To view other panels, swipe to the left or right.

## Moving items



This feature may not be available depending on the region or service provider.

On the Apps screen, tap **EDIT**. Tap and hold an item and drag it to a new location.

To move the item to another panel, drag it to the side of the screen.

## Creating folders



This feature may not be available depending on the region or service provider.

**1** On the Apps screen, tap **EDIT**.

**2** Tap and hold an app, and then drag it over another app.

- 3 Drop the app when a folder frame appears around the apps.  
A new folder containing the selected apps will be created.

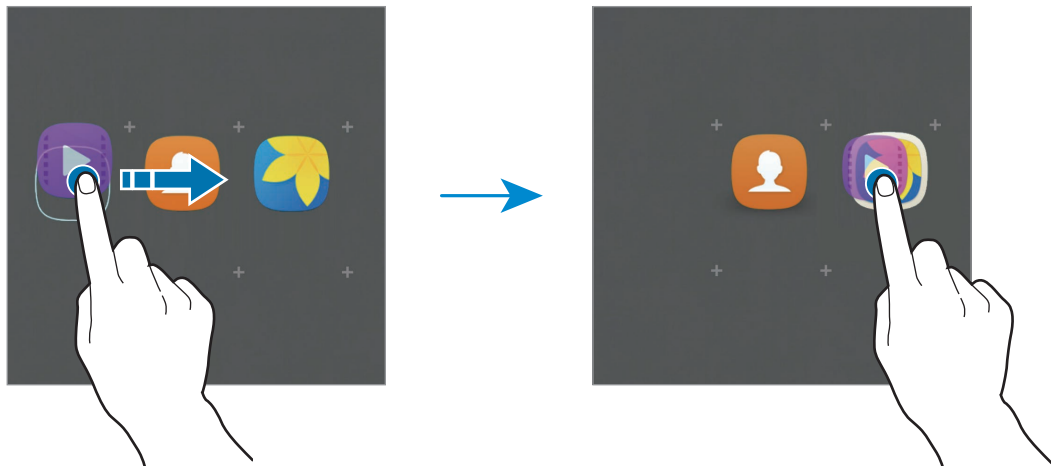

- 4 Tap **Enter folder name** and enter a folder name.  
To change the folder colour, tap 🎨.

To add more apps to the folder, tap and hold another app, and then drag it to the folder.

To delete a folder, select a folder with . Only the folder will be deleted. The folder's apps will be relocated to the Apps screen.

## Rearranging items

You can rearrange items in alphabetical order on the Apps screen.

On the Apps screen, tap **A-Z** → **SAVE**.

## Indicator icons

Indicator icons appear on the status bar at the top of the screen. The icons listed in the table below are most common.



The status bar may not appear at the top of the screen in some apps. To display the status bar, drag down from the top of the screen.

Icon	Meaning
	No signal
	Signal strength
	Currently accessing SIM or USIM card (dual SIM models)
	Roaming (outside of normal service area)
	GPRS network connected
	EDGE network connected
	UMTS network connected
	HSDPA network connected
	HSPA+ network connected
	LTE network connected (LTE-enabled models)
	Wi-Fi connected
	Bluetooth feature activated
	GPS activated
	Call in progress
	Missed call
	New text or multimedia message
	Alarm activated
	Mute mode activated
	Vibration mode activated
	Flight mode activated
	Error occurred or caution required
	Battery power level

## Lock screen

Pressing the Power key turns off the screen and locks it. Also, the screen turns off and automatically locks if the device is not used for a specified period.

To unlock the screen, press the Power key or the Home key and swipe in any direction.

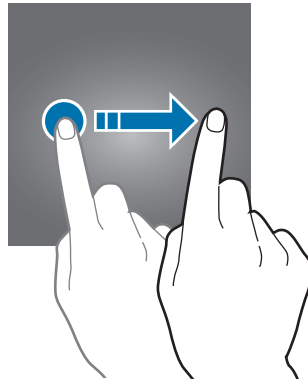

You can change the way that you lock the screen to prevent others from accessing your personal information.

On the Apps screen, tap **Settings** → **Lock screen and security** → **Screen lock type**, and then select a screen lock method. The device requires an unlock code whenever unlocking it.



If the unlock code is forgotten, take the device to a Samsung Service Centre to reset it.

### Pattern

Draw a pattern by connecting four dots or more, and then draw the pattern again to verify it. Set a backup PIN to unlock the screen when you forget the pattern.

### PIN

A PIN consists of numbers only. Enter at least four numbers, and then enter the password again to verify it.

### Password

A password consists of characters and numbers. Enter at least four characters including numbers and symbols, and then enter the password again to verify it.

# Notification panel

## Using the notification panel

When you receive new notifications, such as messages or missed calls, indicator icons appear on the status bar. To see more information about the icons, open the notification panel and view the details.

To open the notification panel, drag the status bar downwards. To close the notification panel, swipe upwards on the screen.

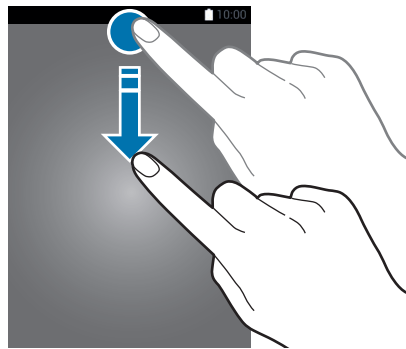

You can use the following functions on the notification panel.

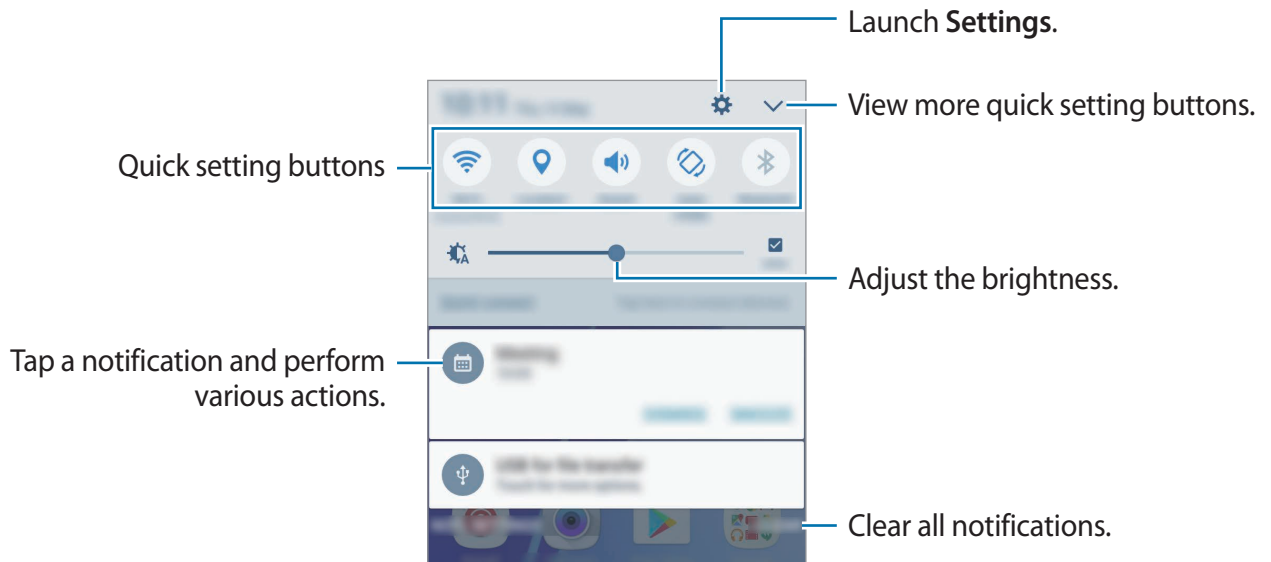

► **Single SIM models:**

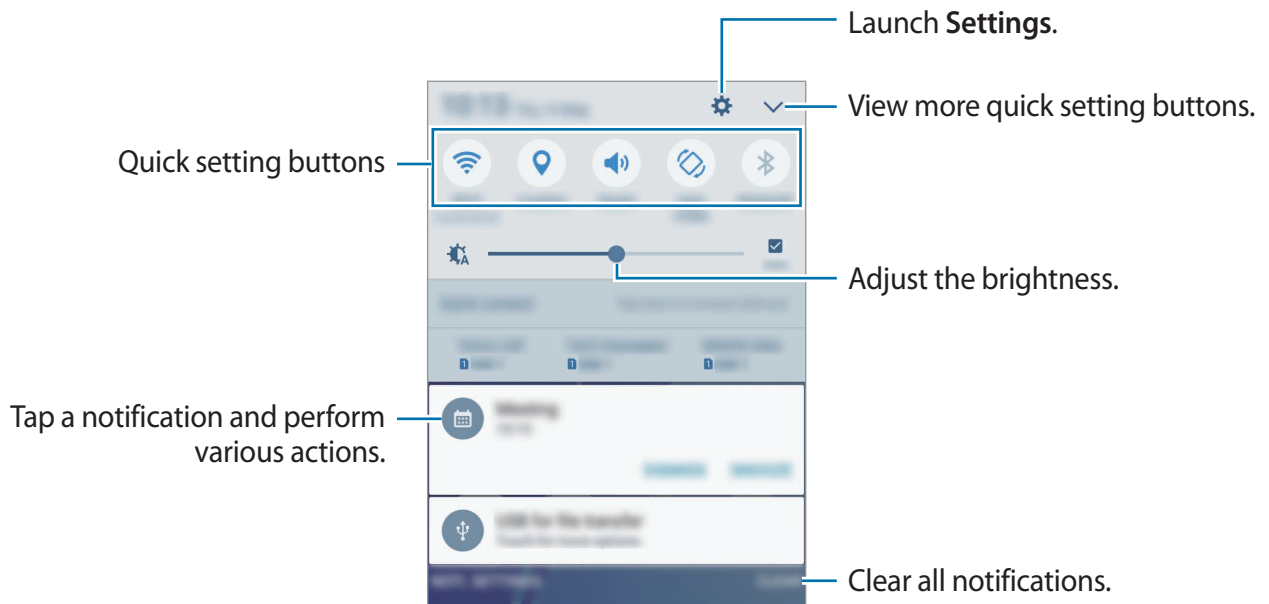

► **Dual SIM models:**



## Using quick setting buttons

Tap quick setting buttons to activate some features. Swipe to the left or right on the buttons area, or tap  to view more buttons. To view more detailed settings, tap and hold a button. To rearrange buttons, tap  → **EDIT**, tap and hold a button, and then drag it to another location.

## Entering text

### Keyboard layout

A keyboard appears automatically when you enter text to send messages, create memos, and more.



Text entry is not supported in some languages. To enter text, you must change the input language to one of the supported languages.

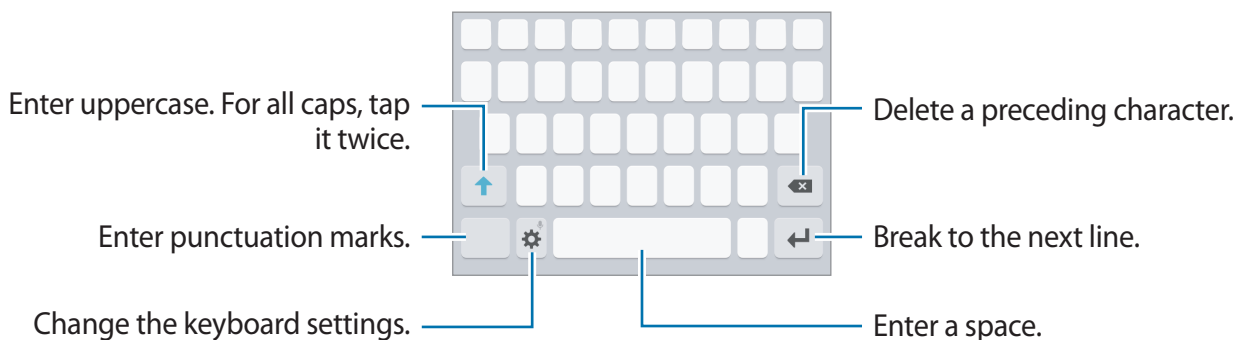

### Changing the input language

Tap  → **Add input languages**, and then select the languages to use. When you select two or more languages, you can switch between the input languages by swiping to the left or right on the space key.



### Changing the keyboard layout

Tap , select a language under **Languages and types**, and then select a keyboard layout to use.



On **3x4 keyboard**, a key has three or four characters. To enter a character, tap the corresponding key repeatedly until the desired character appears.



## Additional keyboard functions

Tap and hold  to use various functions. Other icons may appear instead of the  icon depending on the last function that was used.

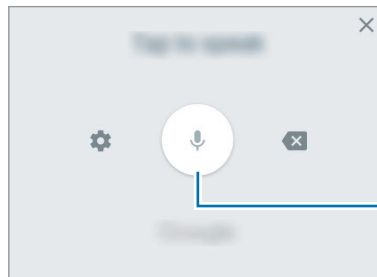

-  : Enter text by voice.



Start or pause entering text by voice.

-  : Add an item from the clipboard.
-  : Enter emoticons.
-  : Change the keyboard settings.

## Copying and pasting

- 1 Tap and hold over text.
- 2 Drag  or  to select the desired text, or tap **Select all** to select all text.
- 3 Tap **Copy** or **Cut**.  
The selected text is copied to the clipboard.
- 4 Tap and hold where the text is to be inserted and tap **Paste**.  
To paste text that you have previously copied, tap **Clipboard** and select the text.



## Screen capture

Capture a screenshot while using the device.

Press and hold the Home key and the Power key simultaneously. You can view captured images in **Gallery**.



It is not possible to capture a screenshot while using some apps and features.

## Opening apps

On the Home screen or the Apps screen, select an app icon to open it.

To open an app from the list of recently used apps, tap  and select a recent app window.

### Closing an app

Tap  and drag a recent app window to the left or right to close it. To close all running apps, tap **CLOSE ALL**.

## Transferring data from your previous device

You can transfer data from a previous device to your new device via Samsung Smart Switch.

The following versions of Samsung Smart Switch are available.

- Mobile version: Transfer data between mobile devices. You can download the app from **Galaxy Apps** or **Play Store**.
- Computer version: Transfer data between your device and a computer. You can download the app from [www.samsung.com/smartswitch](http://www.samsung.com/smartswitch).



- Samsung Smart Switch is not supported on some devices or computers.
- Limitations apply. Visit [www.samsung.com/smartswitch](http://www.samsung.com/smartswitch) for details. Samsung takes copyright seriously. Only transfer content that you own or have the right to transfer.

## Transferring data from a mobile device

Transfer data from your previous device to your new device.



- 1 On both devices, download and install Smart Switch from **Galaxy Apps** or **Play Store**.
- 2 Place the devices near each other.
- 3 Launch **Smart Switch** on both devices.
- 4 On your new device, select the previous device type from the list and tap **START**.
- 5 Follow the on-screen instructions to transfer data from your previous device.

## Transferring backup data from a computer

Back up data from your previous device to a computer and import the data to your new device.

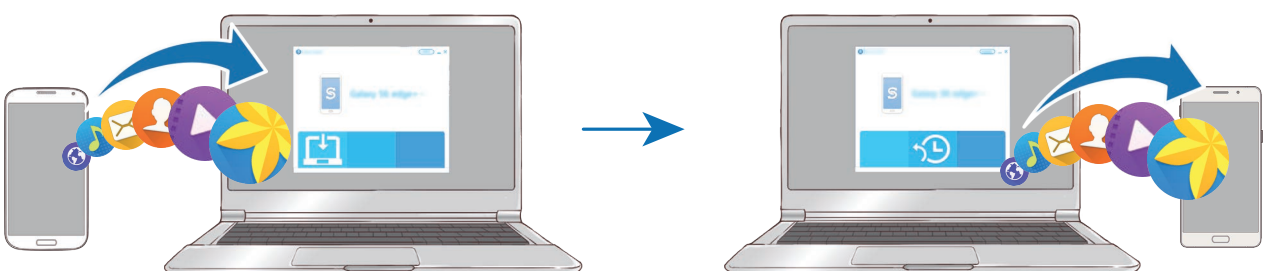



- 1 On the computer, visit [www.samsung.com/smartswitch](http://www.samsung.com/smartswitch) to download Smart Switch.
- 2 On the computer, launch Smart Switch.  
 If your previous device is not a Samsung device, back up data to a computer using a program provided by the device's manufacturer. Then, skip to the fifth step.
- 3 Connect your previous device to the computer using the USB cable.
- 4 On the computer, follow the on-screen instructions to back up data from the device. Then, disconnect your previous device from the computer.
- 5 Connect your new device to the computer using the USB cable.
- 6 On the computer, follow the on-screen instructions to transfer data to your new device.

## Device and data management

### Using the device as a removable disk for data transfer

Move audio, video, image, or other types of files from the device to the computer, or vice versa.

-  Do not disconnect the USB cable from the device when you are transferring files. Doing so may cause data loss or device damage.
-  The devices may not connect properly if they are connected via a USB hub. Directly connect the device to the computer's USB port.

- 1 Connect the device to the computer using the USB cable.
- 2 Open the notification panel, and then tap **USB for file transfer** → **Transferring media files**.

If the computer cannot recognise your device, tap **Transferring images**.

- 3 Tap **ALLOW** to permit the computer to access your device's data.  
When the computer recognises your device, the device will appear in My PC.
- 4 Transfer files between your device and the computer.

## Updating the device

The device can be updated to the latest software.

### Updating over the air

The device can be directly updated to the latest software by the firmware over-the-air (FOTA) service.

On the Apps screen, tap **Settings** → **About device** → **Download updates manually**.



When you tap the **Download update automatically** switch to activate it, updates will be downloaded when the device is connected to a Wi-Fi network.

### Updating with Smart Switch

Connect the device to a computer and update the device to the latest software.

- 1 On the computer, visit [www.samsung.com/smartswitch](http://www.samsung.com/smartswitch) to download and install Smart Switch.
- 2 On the computer, launch Smart Switch.
- 3 Connect the device to the computer using a USB cable.
- 4 If a software update is available, follow the on-screen instructions to update the device.



- Do not turn off the computer or disconnect the USB cable while the device is updating.
- While updating the device, do not connect other media devices to the computer. Doing so may interfere with the update process. Before updating, disconnect all other media devices from the computer.

## Backing up and restoring data

Keep your personal information, app data, and settings safe on your device. You can back up your sensitive information to a backup account and access it later. You must sign in to your Google or Samsung account to back up or restore data. Refer to [Accounts](#) for more information.

### Using a Samsung account

On the Apps screen, tap **Settings** → **Backup and reset** → **Back up my data** for the Samsung account, tap the switches next to the items you want to back up to activate them, and then tap **BACK UP NOW**.

To set the device to automatically back up data, tap the **Auto back up** switch to activate it.

To restore data using a Samsung account, tap **Restore**. Current data will be deleted from the device to restore the selected items.

### Using a Google account

On the Apps screen, tap **Settings** → **Backup and reset** → **Back up my data** for the Google account, and then tap the switch to activate it.

To restore data using a Google account, tap the **Automatic restore** switch to activate it. When you reinstall apps, backed up settings and data will be restored.

## Performing a data reset

Delete all settings and data on the device. Before performing a factory data reset, ensure you back up all important data stored on the device. Refer to [Backing up and restoring data](#) for more information.

On the Apps screen, tap **Settings** → **Backup and reset** → **Factory data reset** → **RESET DEVICE** → **ERASE EVERYTHING**. The device automatically restarts.

## Sharing files with contacts

Share files with your contacts using the simple sharing feature. The following actions are an example of sharing images.



This feature may not be available depending on the region or service provider.

1 Tap **Gallery** on the Apps screen.

2 Select an image.

3 Tap **Share** → **Simple sharing**.

To use this feature, your phone number must be verified.

4 Select recipients and tap **DONE**.

When the image is sent to the recipients' device, a notification will appear on their devices. Tap the notification to view or download the image.



- If the recipients have not verified their phone numbers, or if their devices do not support the simple sharing feature, a link to the files will be sent to them via text message. The link will expire after a certain period.
- You may incur additional charges when sharing files via the mobile network.

## Emergency mode

Emergency mode changes the screen to grey tones to reduce battery consumption. Some apps and functions will be restricted. In emergency mode, you can make an emergency call, send your current location information to others, sound an emergency alarm, and more.

Press and hold the Power key, and then tap **Emergency mode**.

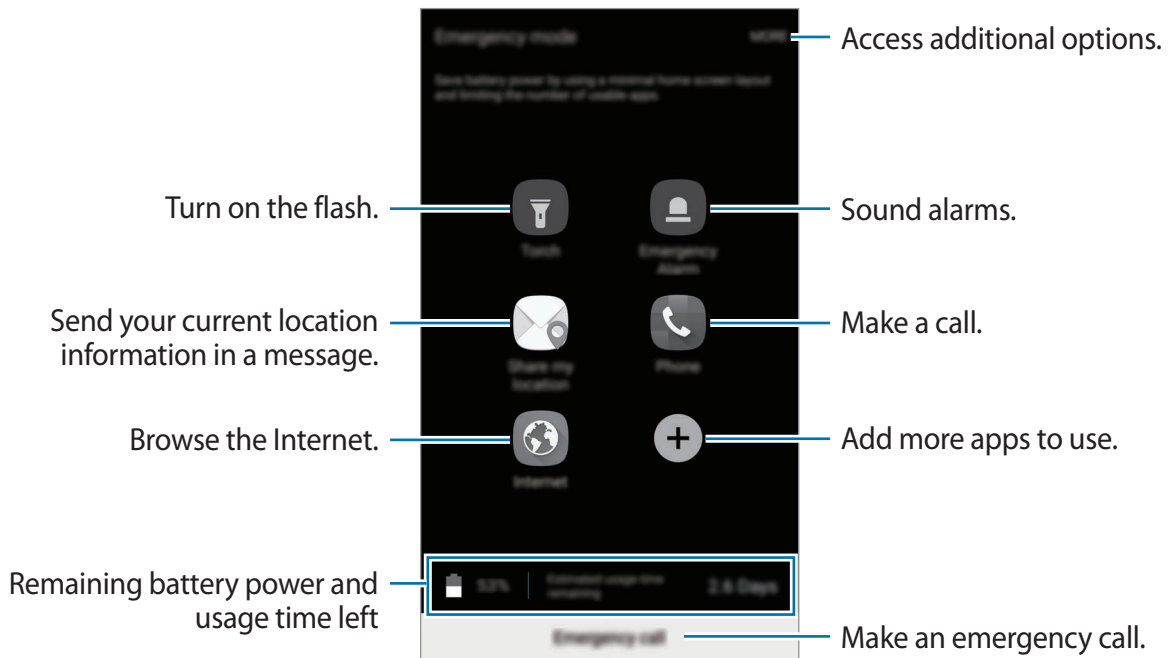

The usage time left shows the time remaining before the battery power runs out. Usage time left may vary depending on your device settings and operating conditions.

## Deactivating emergency mode

To deactivate emergency mode, tap **MORE** → **Disable Emergency mode**. Alternatively, press and hold the Power key, and then tap **Emergency mode**.

# Applications

## Installing or uninstalling apps

### Galaxy Apps

Purchase and download apps. You can download apps that are specialised for Samsung Galaxy devices.

Tap **Galaxy Apps** on the Apps screen.



This app may not be available depending on the region or service provider.

### Installing apps

Browse apps by category or tap **SEARCH** to search for a keyword.

Select an app to view information about it. To download free apps, tap **INSTALL**. To purchase and download apps where charges apply, tap the price and follow the on-screen instructions.



To change the auto update settings, tap **MORE** → **Settings** → **Auto update apps**, and then select an option.

### Play Store

Purchase and download apps.

Tap **Play Store** on the Apps screen.

### Installing apps

Browse apps by category or search for apps by keyword.

Select an app to view information about it. To download free apps, tap **INSTALL**. To purchase and download apps where charges apply, tap the price and follow the on-screen instructions.



To change the auto update settings, tap **≡** → **Settings** → **Auto-update apps**, and then select an option.



## Managing apps

### Uninstalling or disabling apps

On the Apps screen, tap **EDIT**. The  icon appears on the apps that you can disable or uninstall. Select an app and tap **DISABLE** or **OK**. Alternatively, on the Apps screen, tap **Settings** → **Applications** → **Application manager**, select an app, and then tap **DISABLE** or **UNINSTALL**.

- **DISABLE**: Disable selected default apps that cannot be uninstalled from the device.
- **UNINSTALL**: Uninstall downloaded apps.

### Enabling apps

On the Apps screen, tap **Settings** → **Applications** → **Application manager** →  → **Disabled**, select an app, and then tap **ENABLE**.

## Phone

### Introduction

Make or answer voice and video calls.

### Making calls



1 Tap **Phone** on the Apps screen.

2 Enter a phone number.

If the keypad does not appear on the screen, tap  to open the keypad.

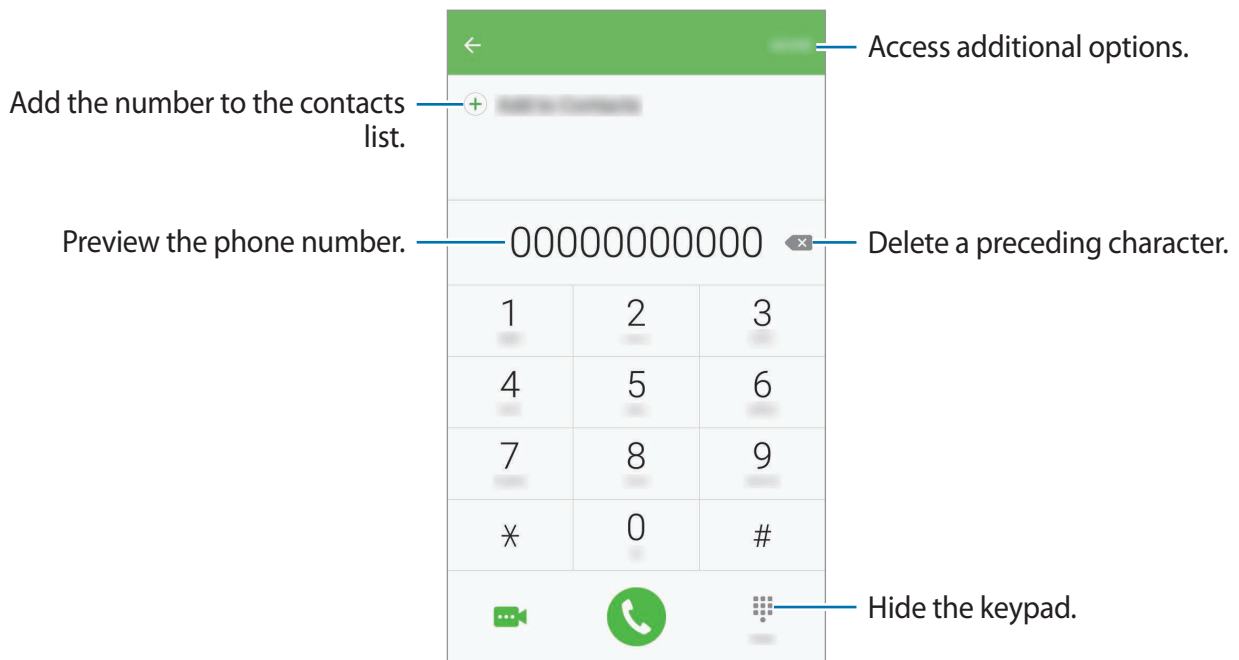
3 ► **Single SIM models:** Tap  to make a voice call, or tap  to make a video call.



► **Dual SIM models:** Tap  or  to make a voice call, or tap  to make a video call.

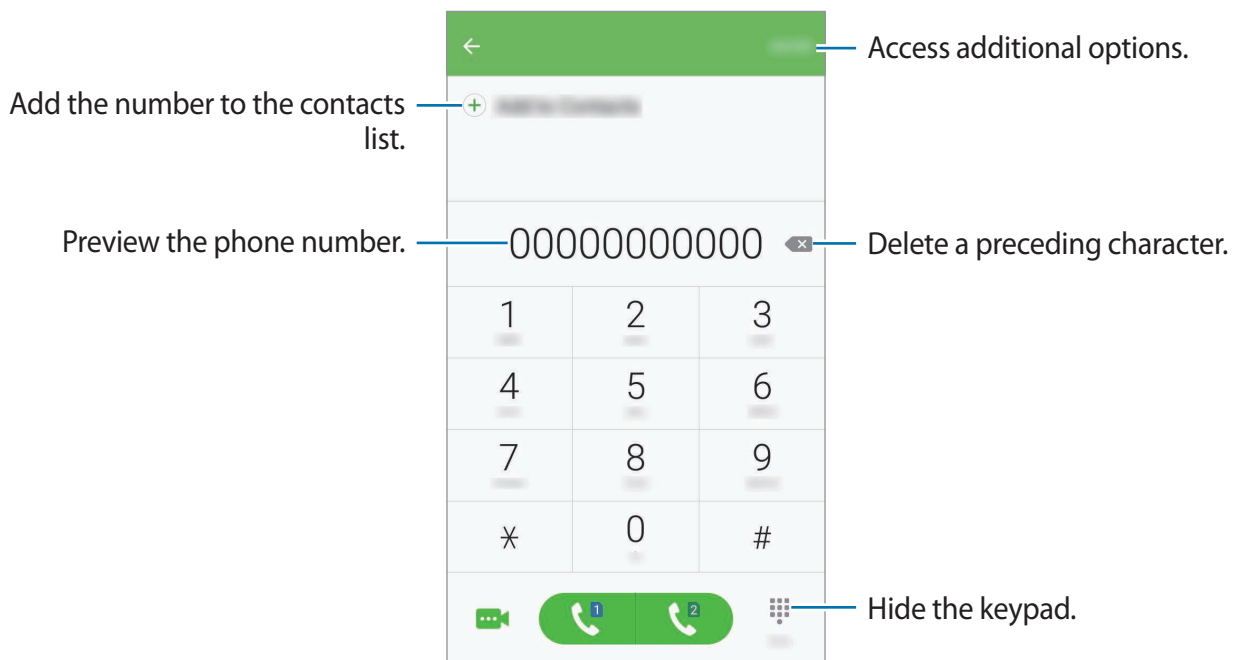

## Using speed dial

Set speed dial numbers to quickly make calls.

To set a number to speed dial, tap **MORE** → **Speed dial**, select a speed dial number, and then select a contact.

To make a call, tap and hold a speed dial number on the keypad. For speed dial numbers 10 and up, tap the first digit(s) of the number, and then tap and hold the last digit.

For example, if you set the number **123** as a speed dial number, tap **1**, tap **2**, and then tap and hold **3**.





## Making calls from the locked screen

On the locked screen, drag  outside the large circle.

## Making calls from call logs or contacts list

Tap **LOG** or **CONTACTS**, and then swipe to the right on a contact or a phone number to make a call.

## Making an international call

- 1 Tap  to open the keypad if the keypad does not appear on the screen.
- 2 Tap and hold **0** until the + sign appears.
- 3
  - ▶ **Single SIM models:** Enter the country code, area code, and phone number, and then tap .
  - ▶ **Dual SIM models:** Enter the country code, area code, and phone number, and then tap  or .

## Receiving calls

### Answering a call

When a call comes in, drag  outside the large circle.

### Rejecting a call

When a call comes in, drag  outside the large circle.

To send a message when rejecting an incoming call, drag the reject message bar upwards.

To create various rejection messages, open the Apps screen and tap **Phone** → **MORE** → **Settings** → **Quick decline messages**, enter a message, and then tap .

### Blocking phone numbers

Reject calls from specific numbers added to your block list.

1 On the Apps screen, tap **Phone** → **MORE** → **Settings** → **Block list**.

2 Tap **LOG** or **CONTACTS** to select contacts and tap .

To manually enter a number, tap **Enter phone number**, and then enter a phone number.

When blocked numbers try to contact you, you will not receive notifications. The calls will be logged in the call log.



You can also reject any phone number that is not saved as a contact. Tap the **Block anonymous calls** switch to activate the feature.

### Missed calls

If a call is missed, the  icon appears on the status bar. Open the notification panel to view the list of missed calls. Alternatively, on the Apps screen, tap **Phone** → **LOG** to view missed calls.

## Options during calls

### During a voice call

The following actions are available:

- **Add call:** Dial a second call.
- **Extra volume:** Increase the volume.
- **Bluetooth:** Switch to a Bluetooth headset if it is connected to the device.
- **Speaker:** Activate or deactivate the speakerphone. When using the speakerphone, speak into the microphone at the bottom of the device and keep the device away from your ears.
- **Keypad / Hide:** Open or close the keypad.
- **Mute:** Turn off the microphone so that the other party cannot hear you.
- **Email:** Send an email.
- **Message:** Send a message.
- **Internet:** Browse webpages.
- **Contacts:** Open the contacts list.
- **S Planner:** Open the calendar.
- **Memo:** Create a memo.
- : End the current call.

### During a video call

Tap the screen to use the following options:

- **Switch:** Switch between the front and rear cameras.
- : End the current call.
- **Mute:** Turn off the microphone so that the other party cannot hear you.





# Contacts

## Introduction

Create new contacts or manage contacts on the device.

## Adding contacts

### Creating contacts manually

- 1 Tap **Contacts** on the Apps screen.
- 2 Tap  and select a storage location.
- 3 Enter contact information.
  -  : Add an image.
  -  /  : Add or delete a contact field.
- 4 Tap **SAVE**.

To add a phone number to the contacts list from the keypad, open the Apps screen and tap **Phone**. If the keypad does not appear on the screen, tap  to open the keypad. Enter the number and tap **Add to Contacts**.

To add a phone number to the contacts list from received calls, open the Apps screen and tap **Phone** → **LOG** → a contact.

### Importing contacts

Import contacts from storage services to your device.

On the Apps screen, tap **Contacts** → **MORE** → **Settings** → **Import/Export contacts** → **IMPORT** and select an import option.





## Searching for contacts

On the Apps screen, tap **Contacts**.

Use one of the following search methods:

- Scroll up or down the contacts list.
- Drag a finger along the index at the right side of the contacts list to scroll through it quickly.
- Tap the search field at the top of the contacts list and enter search criteria.

Once a contact is selected, take one of the following actions:

-  : Add to favourite contacts.
-  /  : Make a voice or video call.
-  : Compose a message.
-  : Compose an email.

## Sharing profile

Share your profile information, such as your photo and status message, with others using the profile sharing feature.



- This feature may not be available depending on the region or service provider.
- This feature is only available for contacts who have activated the profile sharing feature on their device.

On the Apps screen, tap **Contacts** → your profile → **Profile sharing**, and then tap the switch to activate it. To use this feature, your phone number must be verified. You can view your contacts' updated profile information in **Contacts**.

To set additional items to share, tap **Shared profile info** and select items.

To set a contact group to share your profile with, tap **Share with** and select an option.

## Sharing contacts

You can share contacts with others by using various sharing options.

- 1 Tap **Contacts** on the Apps screen.
- 2 Tap **MORE** → **Share**.
- 3 Tick contacts and tap **SHARE**.
- 4 Select a sharing method.

## Messages

### Introduction

Send and view messages by conversation.

### Sending messages



You may incur additional charges for sending messages when you are roaming.

- 1 Tap **Messages** on the Apps screen.
- 2 Tap .



### 3 Add recipients and enter a message.

#### ► Single SIM models:

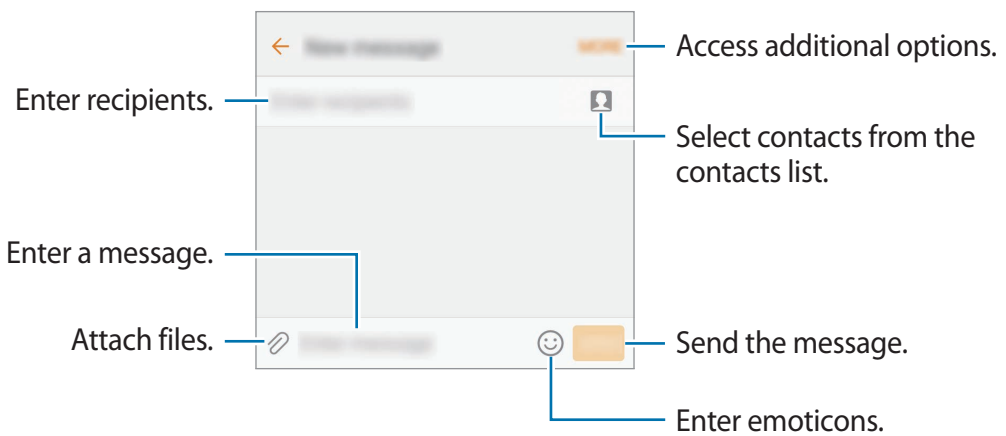

#### ► Dual SIM models:

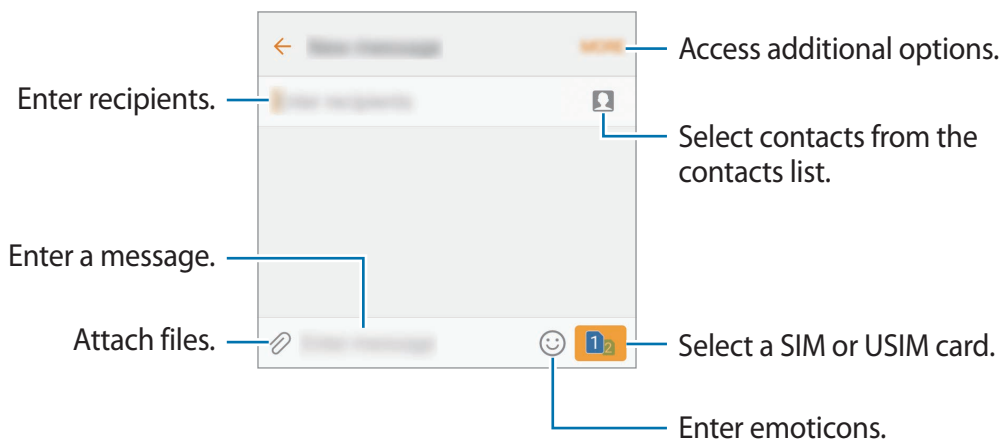

### 4 ► Single SIM models: Tap **SEND** to send the message.

#### ► Dual SIM models: Tap or to send the message.

## Viewing messages

Messages are grouped into message threads by contact.



You may incur additional charges for receiving messages when you are roaming.

- 1 Tap **Messages** on the Apps screen.
- 2 On the messages list, select a contact.
- 3 View your conversation.

## Blocking unwanted messages

Block messages from specific numbers or messages that contain phrases added to your block list.

- 1 Tap **Messages** on the Apps screen.
- 2 Tap **MORE** → **Settings** → **Block messages**.
- 3 Tap **Block list**.  
To add phrases to block, tap **Blocked phrases**.
- 4 Tap **INBOX** or **CONTACTS** to select contacts and tap .

To manually enter a number, tap **Enter number**, and then enter a phone number.

When you receive messages from the blocked numbers or messages including blocked phrases, you will not be notified. To view blocked messages, tap **MORE** → **Settings** → **Block messages** → **Blocked messages**.

## Setting the message notification

You can change notification sound, display options, and more.

- 1 Tap **Messages** on the Apps screen.
- 2 Tap **MORE** → **Settings** → **Notifications**, and then tap the switch to activate it.
- 3 Change the notification settings.
  - **Notification sound:** Change the notification sound.
  - **Vibrate:** Set the device to vibrate when you receive messages.
  - **Pop-up display:** Set the device to display messages in pop-up windows.
  - **Preview message:** Set the device to display message content on the locked screen and in pop-up windows.

You can set an alert at an interval to let you know that you have unchecked notifications. On the Apps screen, tap **Settings** → **Accessibility** → **Notification reminder**, and then tap the switch to activate it. Then, tap the **Messages** switch to activate it.

## Internet

Browse the Internet to search for information and bookmark your favourite webpages to access them conveniently.

- 1 Tap **Internet** on the Apps screen.
- 2 Tap the address field.
- 3 Enter the web address or a keyword, and then tap **Go**.

To view the toolbars, drag your finger downwards slightly on the screen.



## Email

### Setting up email accounts

Set up an email account when opening **Email** for the first time.

- 1 Tap **Email** on the Apps screen.
- 2 Enter the email address and password, and then tap **SIGN IN**.  
To manually register a company email account, tap **MANUAL SETUP**.
- 3 Follow the on-screen instructions to complete the setup.

To set up another email account, tap **MORE** → **Settings** → **Add account**.

If you have more than one email account, you can set one as the default account. Tap **MORE** → **Settings** → **MORE** → **Set default account**.

## Sending emails

- 1 Tap  to compose an email.
- 2 Add recipients and enter an email text.
- 3 Tap **SEND** to send the mail.

## Reading emails

When **Email** is open, the device will automatically retrieve new emails. To manually retrieve emails, swipe downwards on the screen.

Tap an email on the screen to read it.



If email syncing is disabled, new emails cannot be retrieved. To enable email syncing, tap **MORE** → **Settings** → your account name, and then tap the **Sync account** switch to activate it.

# Camera

## Introduction

Take photos and record videos using various modes and settings.

## Basic shooting





You can take photos or record videos. View your photos and videos in **Gallery**.

Tap **Camera** on the Apps screen.

### Camera etiquette

- Do not take photos or record videos of other people without their permission.
- Do not take photos or record videos where legally prohibited.
- Do not take photos or record videos in places where you may violate other people's privacy.

## Taking photos or recording videos

- 1 Tap the image on the preview screen where the camera should focus.
- 2 Tap  to take a photo or tap  to record a video.
  - Spread two fingers apart on the screen to zoom in, and pinch to zoom out.
  - To adjust the brightness of photos or videos, tap the screen. When the adjustment bar appears, tap and hold  and drag it on the adjustment bar.
  - To capture an image from the video while recording, tap **Capture**.
  - To change the focus while recording a video, tap where you want to focus. To focus on the centre of the screen, tap .

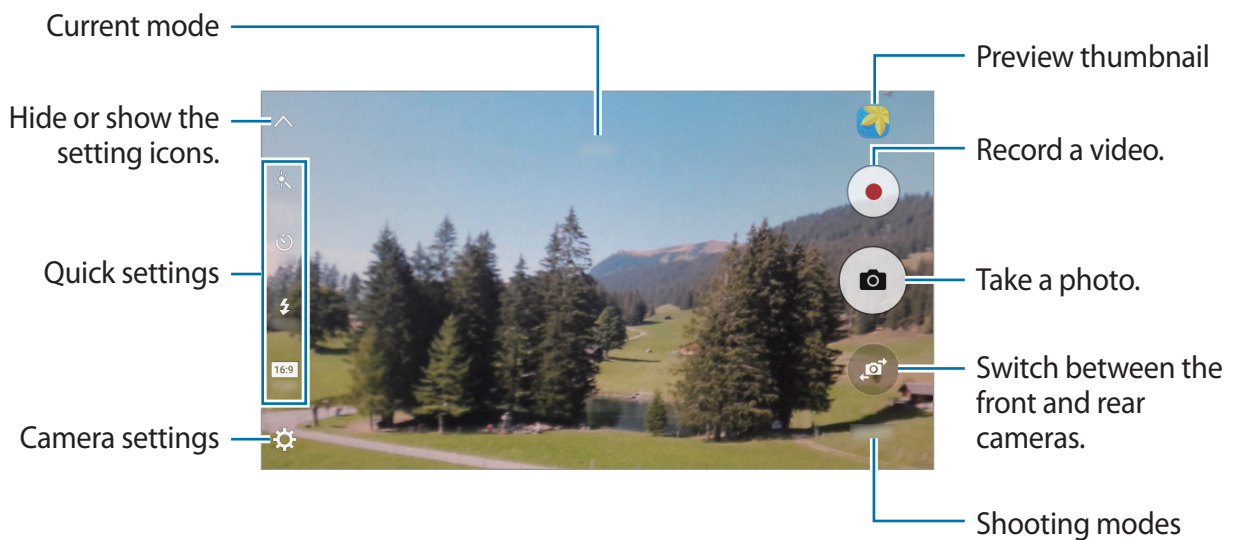

On the preview screen, swipe to the right to access the list of shooting modes. Or, swipe to the left to view photos and videos you have captured.



- The preview screen may vary depending on the shooting mode and which camera is being used.
- The camera automatically shuts off when unused.
- Make sure that the lens is clean. Otherwise, the device may not work properly in some modes that require high resolutions.
- The front camera features a wide-angle lens. Minor distortion may occur in wide-angle photos and does not indicate device performance problems.

## Launching Camera on the locked screen

To quickly take photos, launch **Camera** on the locked screen.

On the locked screen, drag  outside the large circle.



- This feature may not be available depending on the region or service provider.
- Some camera features are not available when you launch **Camera** from the locked screen while the security features are activated.

## Launching Camera quickly

Press the Home key twice quickly to launch **Camera**.



Some camera features are not available when you launch **Camera** from the locked screen or when the screen is turned off while the security features are activated.

## Locking the focus and exposure

Strong light/dark contrast and the subject being outside the auto focus area may make it difficult to achieve an appropriate exposure. Lock the focus or exposure and then take a photo. Tap and hold the area to focus, the AF/AE frame will appear on the area and the focus and exposure setting will be locked. The setting remains locked even after you take a photo.



This feature is only available in some shooting modes.

## Auto mode

Auto mode allows the camera to evaluate the surroundings and determine the ideal mode for the photo.

On the preview screen, tap **MODE** → **Auto**.

## Pro mode

Take photos while manually adjusting various shooting options, such as exposure value and ISO value.

On the preview screen, tap **MODE** → **Pro**. Select options and customise the settings, and then tap  to take a photo.

- **WB**: Select an appropriate white balance, so images have a true-to-life colour range.
- **ISO**: Select an ISO value. This controls camera light sensitivity. Low values are for stationary or brightly lit objects. Higher values are for fast-moving or poorly lit objects. However, higher ISO settings can result in noise in photos.
- : Change the exposure value. This determines how much light the camera's sensor receives. For low-light situations, use a higher exposure.

## Panorama

Take a series of photos horizontally or vertically and then stitch them together to create a wide scene.

On the preview screen, tap **MODE** → **Panorama**.



To get the best shots using panorama mode, follow these tips:

- Move the camera slowly in one direction.
- Keep the image within the frame on the camera's viewfinder.
- Avoid taking photos of indistinct backgrounds, such as an empty sky or a plain wall.

## Continuous shot

Take a series of photos of moving subjects.

On the preview screen, tap **MODE** → **Continuous shot**.

Tap and hold  to take several photos continuously.



## HDR (Rich tone)

Take photos with rich colours and reproduce details even in bright and dark areas.

On the preview screen, tap **MODE** → **HDR (Rich tone)**.



Without effect



With effect



## Night

Take a photo in low-light conditions, without using the flash.

On the preview screen, tap **MODE** → **Night**.



## Selfie

Take self-portraits with the front camera.

- 1 On the preview screen, tap  to switch to the front camera for self-portraits.
- 2 Tap **MODE** → **Selfie**.
- 3 Face the front camera lens.
- 4 When the device detects your face, tap the screen to take a photo of yourself.  
To take a photo using your palm, tap  and tap the **Gesture control** switch to activate it. Show your palm to the front camera. After recognising your palm, the device will take a photo after a few seconds.

## Wide selfie

Take a wide self-portrait to include more people in the photo and avoid leaving people out.

- 1 On the preview screen, tap  to switch to the front camera for self-portraits.
- 2 Tap **MODE** → **Wide selfie**.
- 3 Face the front camera lens.
- 4 When the device detects your face, tap the screen to take a photo of yourself.  
To take a photo using your palm, tap  and tap the **Gesture control** switch to activate it. Show your palm to the front camera. After recognising your palm, the device will take a photo after a few seconds.
- 5 Slowly swivel the device left and then right or vice versa to take a wide self-portrait.  
The device will take additional photos when the white frame moves to each end of the viewfinder window.

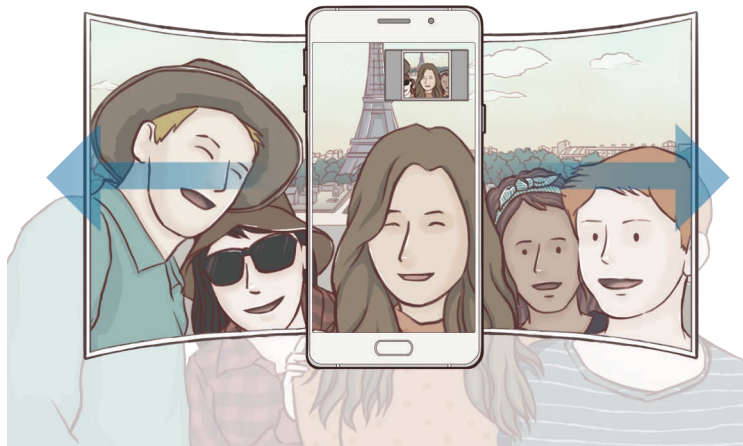

- Make sure to keep the white frame inside the viewfinder window.
- The subjects should remain still while taking wide self-portraits.
- The top and bottom parts of the image displayed on the preview screen may be cut out of the photo depending on the shooting conditions.

## Downloading modes

Download more shooting modes from **Galaxy Apps**.

On the preview screen, tap **MODE** → **Download**.



Some downloaded shooting modes do not have access to every feature. Swiping right to view the modes list and swiping left to view captured images and videos may not be available.





## Camera settings

### Quick settings

On the preview screen, use the following quick settings.



The available options may vary depending on the shooting mode and which camera is being used.

-  : Select a filter effect to use when taking photos or recording videos.
-  : Select a metering method. This determines how light values are calculated. **Centre-weighted** uses the light in the centre portion of the shot to calculate the exposure of the shot. **Spot** uses the light in a concentrated centre area of the shot to calculate the exposure of the shot. **Matrix** averages the entire scene.
-  : Select the length of the delay before the camera automatically takes a photo.
-  : Activate or deactivate the flash.
-  : Adjust the slide bar to take a photo with lightened faces for gentler images.
- **16:9** / **4:3** : Select a resolution for photos. Using a higher resolution will result in higher quality photos, but they will take up more memory.



The resolution of a photo may be affected by lighting conditions.

## Camera settings

On the preview screen, tap .



The available options may vary depending on the shooting mode and which camera is being used.

- **Video size (rear) / Video size (front):** Select a resolution for videos. Using a higher resolution will result in higher quality videos, but they will take up more memory.
- **Gesture control:** Set the device to detect your palm, so you can use it to take self-portraits.
- **Save pictures as previewed:** Invert the image to create a mirror-image of the original scene, when taking photos with the front camera.
- **Grid lines:** Display viewfinder guides to help composition when selecting subjects.
- **Location tags:** Attach a GPS location tag to the photo.



- GPS signal strength may decrease in locations where the signal is obstructed, such as between buildings or in low-lying areas, or in poor weather conditions.
- Your location may appear on your photos when you upload them to the Internet. To avoid this, deactivate the location tag setting.

- **Review pictures:** Set the device to show photos after capturing them.
- **Quick launch:** Set the device to launch the camera by pressing the Home key twice quickly.
- **Voice control:** Set the device to take photos or record videos with voice commands. You can say "Smile", "Cheese", "Capture", or "Shoot" to take a photo. To record a video, say "Record video."
- **Storage location:** Select the memory location for storage.
- **Volume keys function:** Set the device to use the Volume key to control the shutter or zoom function.
- **Reset settings:** Reset the camera settings.

# Gallery

## Introduction

View and manage photos and videos stored in the device.

## Viewing images or videos

1 Tap **Gallery** on the Apps screen.

2 Select an image or a video.

Video files show the  icon on the preview thumbnail. To play a video, tap .

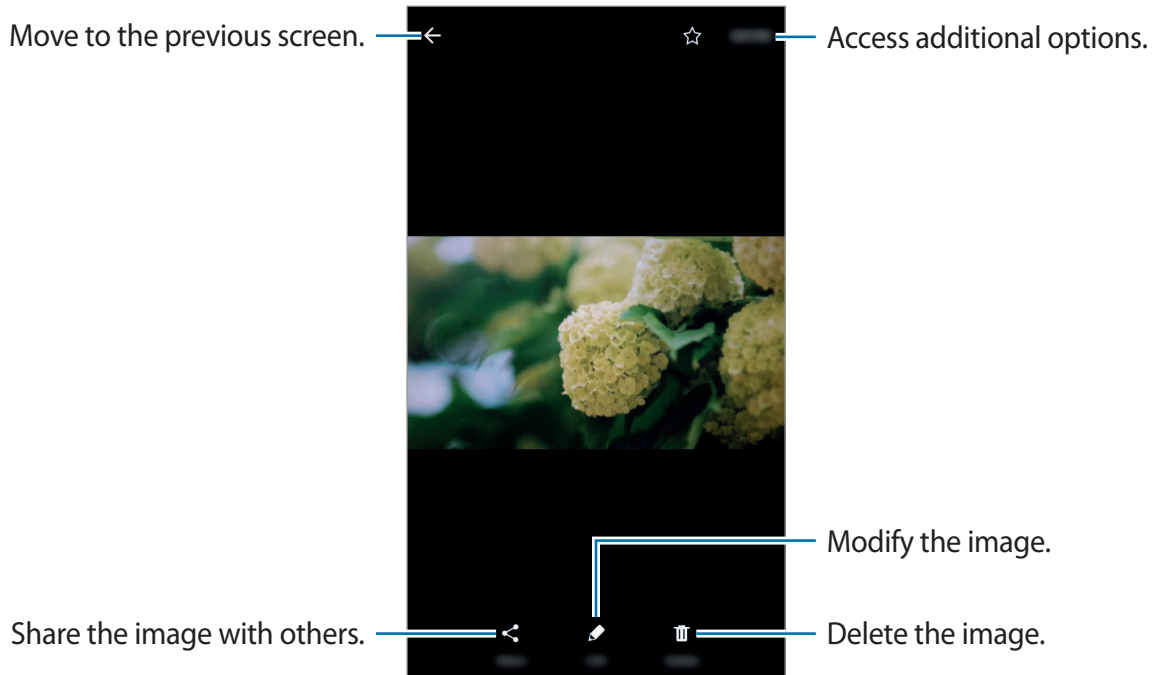

To hide or show the menus, tap the screen.

## Deleting images or videos

### Deleting an image or a video

Select an image or a video and tap **Delete** at the bottom of the screen.

### Deleting multiple images and videos

- 1 On the Gallery main screen, tap and hold an image or a video to delete.
- 2 Tick the images or videos to delete.
- 3 Tap **DELETE**.

## Sharing images or videos

Select an image or a video, tap **Share** at the bottom of the screen, and then select a sharing method.

# Smart Manager

## Introduction

The Smart manager provides an overview of the status of your device's battery, storage, RAM, and system security. You can also automatically optimise the device with one tap of your finger.

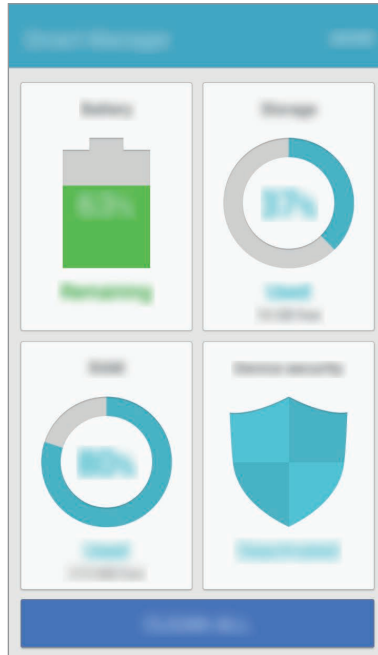

Some features of this app may not be available depending on the region or service provider.

## Using the quick optimisation feature

On the Apps screen, tap **Smart Manager** → **CLEAN ALL**.

The quick optimisation feature improves device performance through the following actions.

- Identifying apps that use excessive battery power and clearing some memory.
- Deleting unnecessary files and closing apps running in the background.
- Scanning for malware.

## Managing device performance

On the Apps screen, tap **Smart Manager** and select a feature.

### Battery

Check the remaining battery power and time to use the device. For devices with low battery levels, conserve battery power by activating power saving features and closing apps that are consuming an excessive amount of battery power.



The usage time left shows the time remaining before the battery power runs out. Usage time left may vary depending on your device settings and operating conditions.

### Storage

Check the status of used and available memory capacity. You can delete unused and residual files or uninstall apps that you do not use any more.

### RAM

Check the amount of available RAM. You can close background apps and reduce the amount of RAM you are using to speed up your device.

### Device security

Check the device's security status. This feature scans your device for malware.



# S Planner

## Introduction

Manage your schedule by entering upcoming events or tasks in your planner.

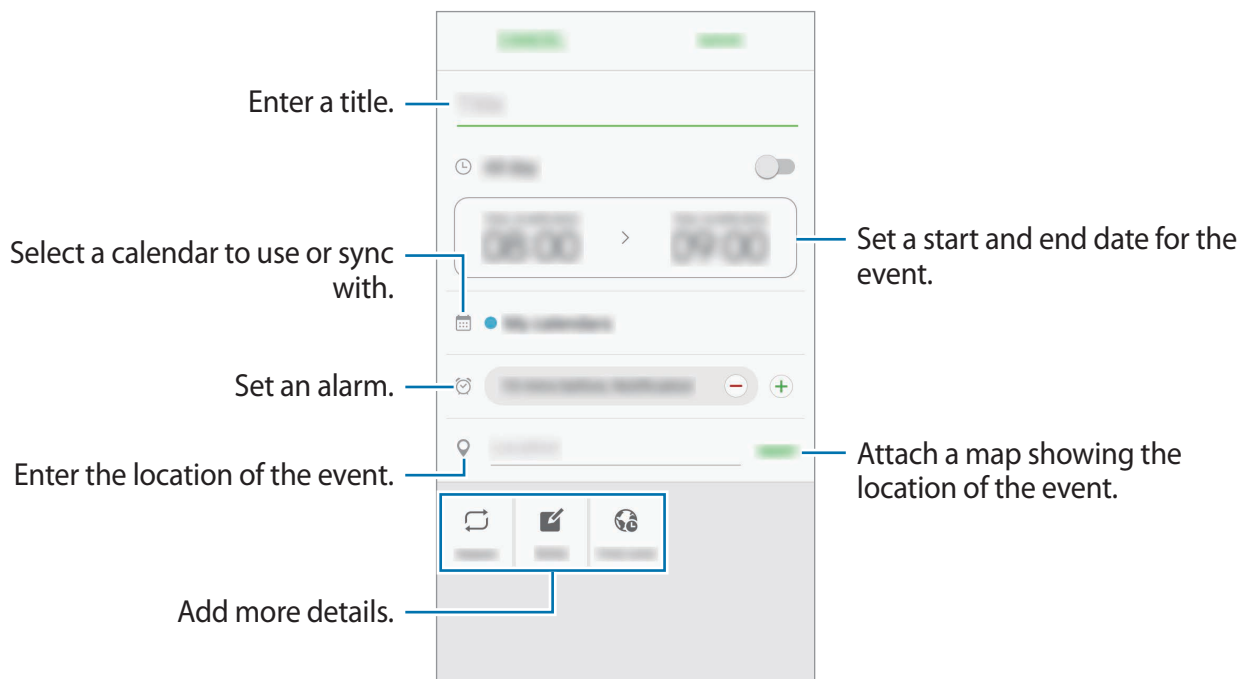

## Creating events

- 1 Tap **S Planner** on the Apps screen.
- 2 Tap **+** or double-tap a date.  
If the date already has saved events or tasks in it, tap the date and tap **+**.
- 3 Enter event details.



- 4 Tap **SAVE** to save the event.

## Creating tasks

- 1 Tap **S Planner** on the Apps screen.
- 2 Tap  → **Tasks**.
- 3 Enter task details and tap **TODAY** or **TOMORROW** to set a due date.  
To add more details, tap .
- 4 Tap **SAVE** to save the task.

## Syncing events and tasks with your accounts

On the Apps screen, tap **Settings** → **Accounts**, select an account service, and then tap the **Sync Calendar** switch to sync events and tasks with the account.

To add accounts to sync with, open the Apps screen and tap **S Planner** → **MORE** → **Manage calendars** → **Add account**. Then, select an account to sync with and sign in. When an account is added, a blue circle is displayed next to the account name.

## S Voice

### Introduction

Perform various tasks simply by speaking.

### Setting a wake-up command

You can launch **S Voice** using your own wake-up command.

When launching **S Voice** for the first time, tap **START** and set your own wake-up command.

To change the wake-up command, open the Apps screen and tap **S Voice**. Then, tap  → **Voice wake-up** → **Change wake-up command** → **START**, and then follow the on-screen instructions.

To set the device to launch **S Voice** using the wake-up command while the device is locked, tap  and tap the **Wake up in secured lock** switch to activate it.

## Using S Voice

1 On the Apps screen, tap **S Voice**.

When **S Voice** is launched, the device begins voice recognition.



This app may not be available depending on the region or service provider.



2 Say a voice command.

If the device recognises the command, the device will perform the corresponding action.

To repeat a voice command or say a different command, tap .



This app will close automatically if the device is not used for a specified period.

### Tips for better voice recognition

- Speak clearly.
- Speak in quiet places.
- Do not use offensive or slang words.
- Avoid speaking in dialectal accents.

The device may not recognise your commands or may perform unwanted commands depending on your surroundings or how you speak.

## Setting the language

On the Apps screen, tap **S Voice** →  → **Language**, and then select a language.



The selected language is applied to **S Voice** only, not to the language displayed on the device.

## Music

Listen to music sorted by category and customise playback settings.

Tap **Music** on the Apps screen.

Select a category, and then select a song to play.

Tap the album image at the bottom of the screen to open the music player screen.

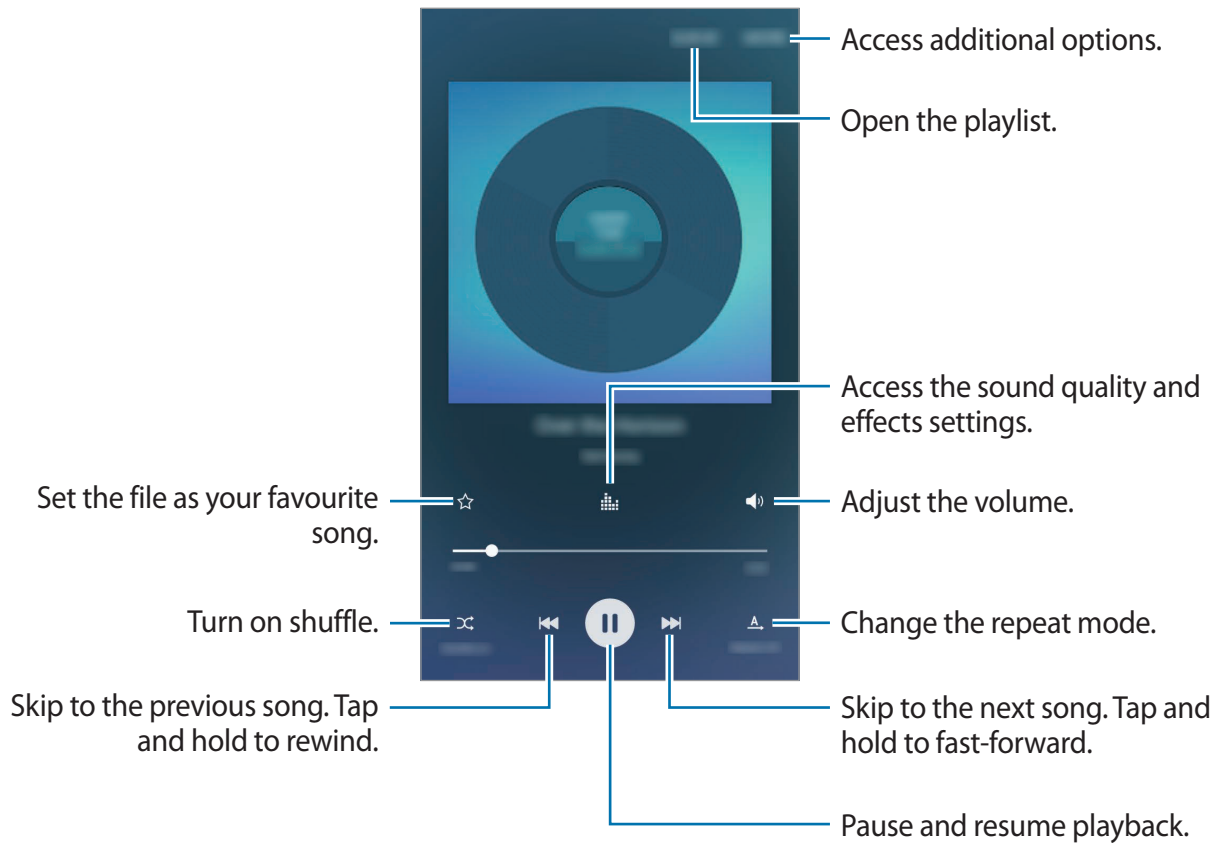

## Video

Watch videos stored in the device and customise playback settings.

Tap **Video** on the Apps screen.

Select a video to play.

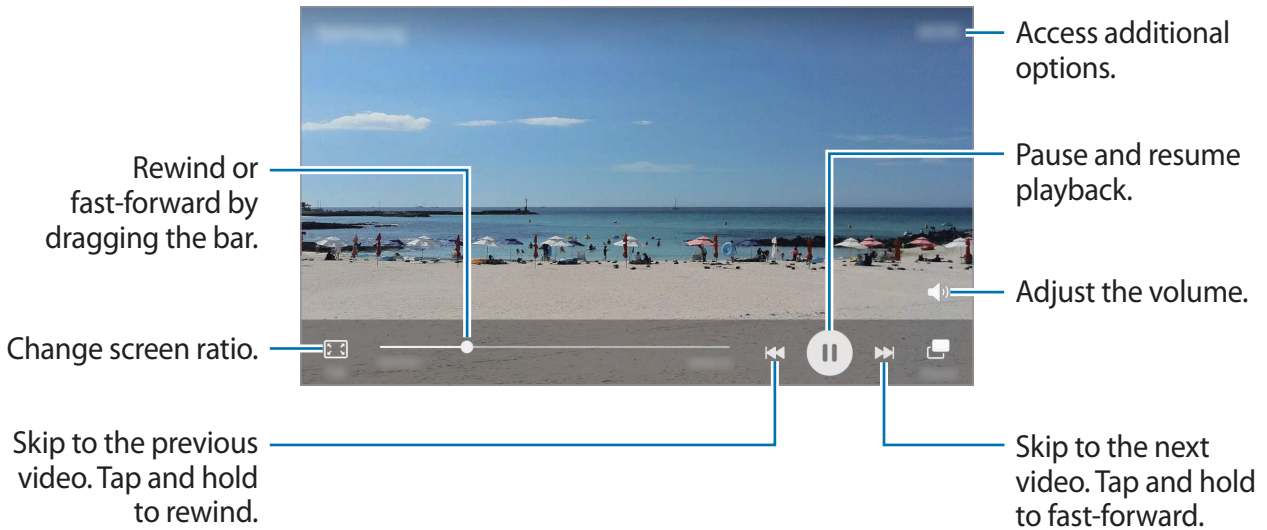

Drag your finger up or down on the left side of the playback screen to adjust the brightness, or drag your finger up or down on the right side of the playback screen to adjust the volume.



To rewind or fast-forward, swipe to the left or right on the playback screen.

# Voice Recorder

## Introduction

Use different recording modes for various situations. The device can convert your voice to text.

## Recording voice memos

- 1 On the Apps screen, tap **Tools** → **Voice Recorder**.
- 2 Tap  to start recording. Speak into the microphone.  
Tap  to pause recording.  
While recording a voice memo, tap **BOOKMARK** to insert a bookmark.

Change the recording mode.

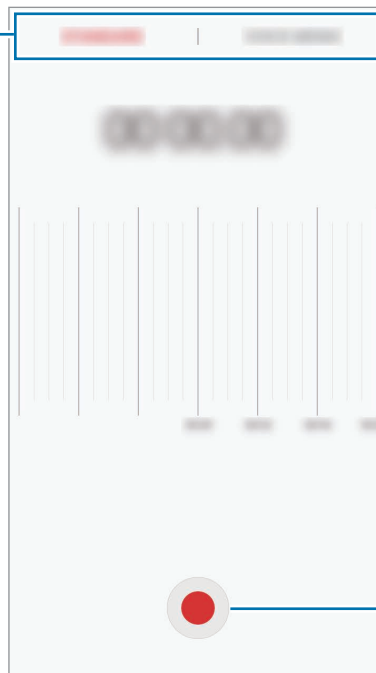

Start recording.

- 3 Tap **SAVE** to finish recording.

## Changing the recording mode

On the Apps screen, tap **Tools** → **Voice Recorder**.

Select a mode from the top of the voice recorder screen.

- **STANDARD**: This is the normal recording mode.
- **VOICE MEMO**: The device records your voice and simultaneously converts it to on-screen text. For best results, keep the device near your mouth and speak loudly and clearly in a quiet place.



If the voice memo system language does not match the language you are speaking, the device will not recognise your voice. Before using this feature, tap the current language to set the voice memo system language.

## My Files

Access and manage various files stored in the device.

On the Apps screen, tap **Tools** → **My Files**.

View files by category or view files stored in the device.

To check the status of used and available memory, tap **STORAGE USAGE**.

To search for files or folders, tap **SEARCH**.

## Memo

Create memos and organise them by category.

On the Apps screen, tap **Tools** → **Memo**.

### Composing memos

Tap  on the memos list and enter a memo. While composing a memo, use the following options:

- **Category:** Create or set a category.
- **Tasks:** Add tick boxes at the beginning of each row to create a list of tasks.
- **Image:** Insert images.
- **Drawing:** Write or draw memos to insert. You can select pen thickness and colour.
- **Voice:** Make a voice recording to insert.

To save the memo, tap **SAVE**.

To edit a memo, tap a memo, and then tap the content of the memo.

### Searching for memos

Tap **SEARCH** on the memos list and enter a keyword to search for memos that include the keyword.

## Clock

### Introduction

Set alarms, check the current time in many cities around the world, time an event, or set a specific duration.



## Alarm

On the Apps screen, tap **Clock** → **Alarm**.

### Setting alarms

Tap **ADD** in the alarms list, set an alarm time, select the days on which the alarm will repeat, set other various alarm options, and then tap **SAVE**.

To open the keypad to enter an alarm time, tap the time input field.

To activate or deactivate alarms, tap the clock icon next to the alarm in the alarms list.

### Stopping alarms

Tap **DISMISS** to stop an alarm. If you have previously enabled the snooze option, tap **SNOOZE** to repeat the alarm after a specified length of time.

### Deleting alarms

Tap ✕ on an alarm in the list of alarms.

## World clock

On the Apps screen, tap **Clock** → **World clock**.

### Creating clocks

Tap **ADD** and enter a city name or select a city from the cities list.

### Deleting clocks

Tap ✕ on a clock.

## Stopwatch

- 1 On the Apps screen, tap **Clock** → **Stopwatch**.
- 2 Tap **START** to time an event.  
To record lap times while timing an event, tap **LAP**.
- 3 Tap **STOP** to stop timing.  
To restart the timing, tap **RESUME**.  
To clear lap times, tap **RESET**.

## Timer

- 1 On the Apps screen, tap **Clock** → **Timer**.
- 2 Set the duration, and then tap **START**.  
To open the keypad to enter the duration, tap the duration input field.
- 3 Tap **DISMISS** when the timer goes off.

## Calculator

Perform simple or complex calculations.

Tap **Calculator** on the Apps screen.

Rotate the device to landscape orientation to display the scientific calculator. If **Auto rotate** is disabled, tap  to display the scientific calculator.

To see the calculation history, tap **HISTORY**. To close the calculation history panel, tap **KEYPAD**.

To clear the history, tap **HISTORY** → **CLEAR HISTORY**.

# Radio

## Listening to the FM radio

Tap **Radio** on the Apps screen.

Before you use this app, you must connect a headset, which serves as the radio antenna.



The FM radio scans and saves available stations automatically when running for the first time.

Tap  to turn on the FM radio. Select the radio station you want from the stations list.

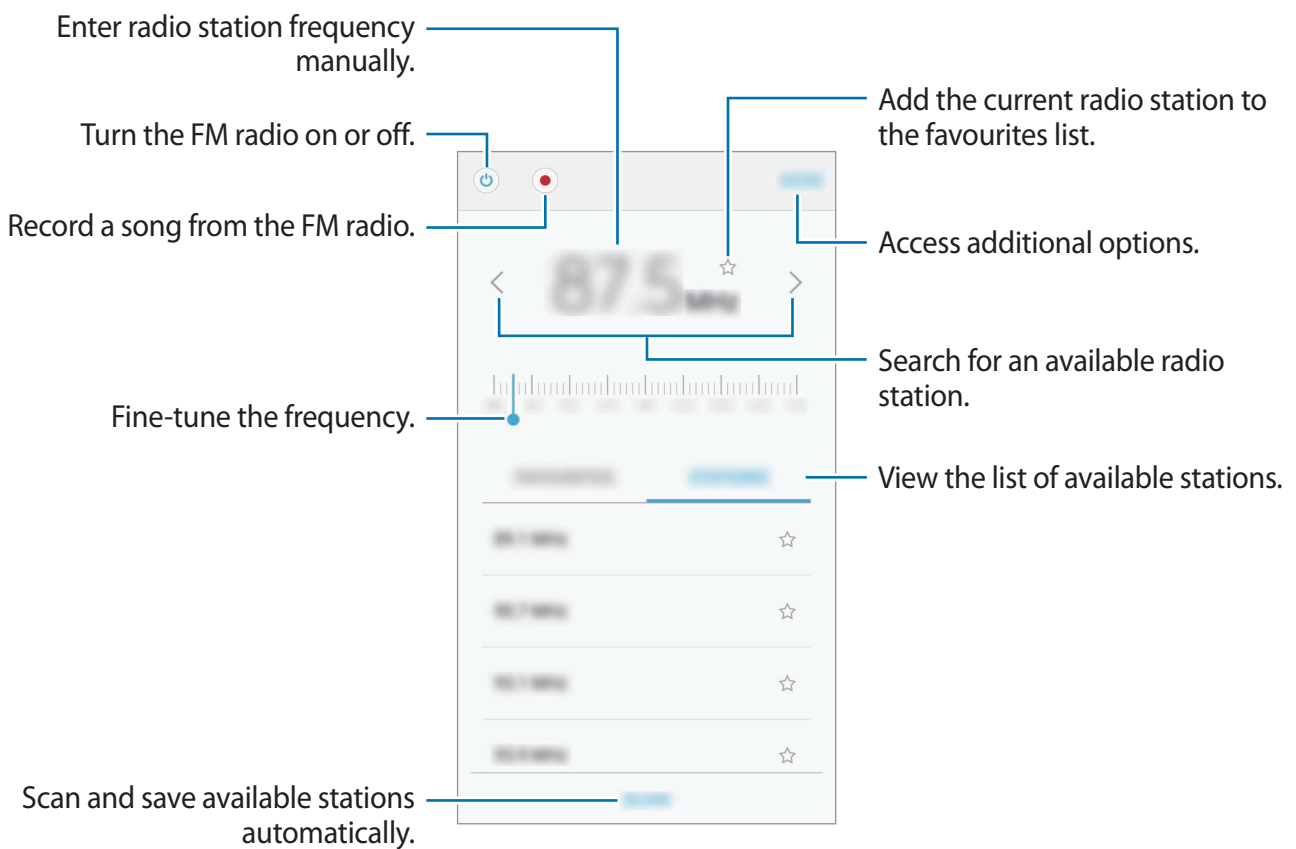

## Scanning radio stations

Tap **Radio** on the Apps screen.

Tap **SCAN**, and then select a scan option. The FM radio scans and saves available stations automatically.

Select the radio station you want from the stations list.

## Google apps

Google provides entertainment, social network, and business apps. You may require a Google account to access some apps. Refer to [Accounts](#) for more information.

To view more app information, access each app's help menu.



Some apps may not be available or may be labelled differently depending on the region or service provider.

### Chrome

Search for information and browse webpages.

### Gmail

Send or receive emails via the Google Mail service.

### Maps

Find your location on the map, search for locations, and view location information for various places.

### Play Music

Discover, listen to, and share music on your device.

## **Play Movies & TV**

Download videos to watch from **Play Store**.

## **Drive**

Store your content on the cloud, access it from anywhere, and share it with others.

## **YouTube**

Watch or create videos and share them with others.

## **Photos**

Search for, manage, and edit all your photos and videos from various sources in one place.

## **Hangouts**

Chat with your friends individually or in groups and use images, emoticons, and video calls while you are chatting.

## **Google**

Search quickly for items on the Internet or your device.

# Settings

## Introduction

Customise settings for functions and apps. You can make your device more personalised by configuring various setting options.

On the Apps screen, tap **Settings**.

To search for settings by entering keywords, tap **SEARCH**.

To edit the list of frequently used settings, tap **EDIT**. Then, tick items to add or deselect items to remove.

## Wi-Fi

### Connecting to a Wi-Fi network

Activate the Wi-Fi feature to connect to a Wi-Fi network and access the Internet or other network devices.



Turn off Wi-Fi to save the battery when not in use.

- 1 On the Settings screen, tap **Wi-Fi**, and then tap the switch to activate it.
- 2 Select a network from the Wi-Fi networks list.  
Networks that require a password appear with a lock icon.

### 3 Tap **CONNECT**.



- Once the device connects to a Wi-Fi network, the device will reconnect to that network each time it is available without requiring a password. To prevent the device connecting to the network automatically, select it from the list of networks and tap **FORGET**.
- If you cannot connect to a Wi-Fi network properly, restart your device's Wi-Fi feature or the wireless router.

## Wi-Fi Direct

Wi-Fi Direct connects devices directly via a Wi-Fi network without requiring an access point.

1 On the Settings screen, tap **Wi-Fi**, and then tap the switch to activate it.

2 Tap **Wi-Fi Direct**.

The detected devices are listed.

If the device you want to connect to is not in the list, request that the device turns on its Wi-Fi Direct feature.

3 Select a device to connect to.

The devices will be connected when the other device accepts the Wi-Fi Direct connection request.

## Sending and receiving data

You can share data, such as contacts or media files, with other devices. The following actions are an example of sending an image to another device.

1 Tap **Gallery** on the Apps screen.

2 Select an image.

3 Tap **Share** → **Wi-Fi Direct** and select a device to transfer the image to.

4 Accept the Wi-Fi Direct connection request on the other device.

If the devices are already connected, the image will be sent to the other device without the connection request procedure.

## Ending the device connection

1 Tap **Wi-Fi** on the Settings screen.

2 Tap **Wi-Fi Direct**.

The device displays the connected devices in the list.

3 Tap the device name to disconnect the devices.

# Bluetooth

## Introduction

Use Bluetooth to exchange data or media files with other Bluetooth-enabled devices.



- Samsung is not responsible for the loss, interception, or misuse of data sent or received via Bluetooth.
- Always ensure that you share and receive data with devices that are trusted and properly secured. If there are obstacles between the devices, the operating distance may be reduced.
- Some devices, especially those that are not tested or approved by the Bluetooth SIG, may be incompatible with your device.
- Do not use the Bluetooth feature for illegal purposes (for example, pirating copies of files or illegally tapping communications for commercial purposes).

Samsung is not responsible for the repercussion of illegal use of the Bluetooth feature.



## Pairing with other Bluetooth devices

1 On the Settings screen, tap **Bluetooth**, and then tap the switch to activate it.  
The detected devices are listed.

2 Select a device to pair with.

If the device you want to pair with is not in the list, request that the device turns on its visibility option. Refer to the other device's user manuals.



Your device is visible to other devices while the Bluetooth settings screen is open.

3 Accept the Bluetooth connection request on your device to confirm.

The devices will be connected when the other device accepts the Bluetooth connection request.

## Sending and receiving data

Many apps support data transfer via Bluetooth. You can share data, such as contacts or media files, with other Bluetooth devices. The following actions are an example of sending an image to another device.

1 Tap **Gallery** on the Apps screen.

2 Select an image.

3 Tap **Share** → **Bluetooth**, and then select a device to transfer the image to.

If your device has paired with the device before, tap the device name without confirming the auto-generated passkey.

If the device you want to pair with is not in the list, request that the device turns on its visibility option.

4 Accept the Bluetooth connection request on the other device.

## Unpairing Bluetooth devices

- 1 Tap **Bluetooth** on the Settings screen.  
The device displays the paired devices in the list.
- 2 Tap  next to the device name to unpair.
- 3 Tap **Unpair**.

## Flight mode

This disables all wireless functions on your device. You can use only non-network services. On the Settings screen, tap **Flight mode**.



Make sure the device is turned off during takeoff and landing. After takeoff, you can use the device in flight mode if allowed by aircraft personnel.

## Mobile hotspot and tethering

Use the device as a mobile hotspot to share the device's mobile data connection with other devices when the network connection is not available. Connections can be made via Wi-Fi, USB, or Bluetooth.

On the Settings screen, tap **Mobile hotspot and tethering**.



You may incur additional charges when using this feature.

- **Mobile hotspot:** Use the mobile hotspot to share the device's mobile data connection with computers or other devices.
- **Bluetooth tethering:** Use Bluetooth tethering to share the device's mobile data connection with computers or other devices via Bluetooth.
- **USB tethering:** Use USB tethering to share the device's mobile data connection with a computer via USB. When connected to a computer, the device is used as a wireless modem for the computer.

## Using the mobile hotspot

Use your device as a mobile hotspot to share your device's mobile data connection with other devices.

- 1 On the Settings screen, tap **Mobile hotspot and tethering** → **Mobile hotspot**.
- 2 Tap the switch to activate it.  
The  icon appears on the status bar. Other devices can find your device in the Wi-Fi networks list.  
To set a password for the mobile hotspot, tap **MORE** → **Configure Mobile hotspot** and select the level of security. Then, enter a password and tap **SAVE**.
- 3 On the other device's screen, search for and select your device from the Wi-Fi networks list.
- 4 On the connected device, use the device's mobile data connection to access the Internet.

## Data usage

Keep track of your data usage amount and customise the settings for the limitation.

On the Settings screen, tap **Data usage**.

- **Mobile data:** Set the device to use data connections on any mobile network.
- **Background data:** Prevent apps that are running in the background from using a mobile data connection.
- **Set mobile data limit:** Set a limit for mobile data usage.

To change the monthly reset date for the monitoring period, tap  → **Change cycle**.

## Limiting data usage

- 1 On the Settings screen, tap **Data usage** and tap the **Set mobile data limit** switch to activate it.
- 2 Drag the limit adjustment bar upwards or downwards to set the limit.
- 3 Drag the warning adjustment bar upwards or downwards to set a data usage alert level. The device will alert you when the warning level is reached.

## SIM card manager (dual SIM models)

Activate your SIM or USIM cards and customise the SIM card settings. Refer to [Using dual SIM or USIM cards \(dual SIM models\)](#) for more information.

On the Settings screen, tap **SIM card manager**.

- **Calls:** Select a SIM or USIM card for voice calls.
- **Text messages:** Select a SIM or USIM card for messaging.
- **Mobile data:** Select a SIM or USIM card for data service.
- **Dual SIM always on:** Set the device to allow incoming calls from the other SIM or USIM card during a call.



When this feature is enabled, you may incur additional charges for call forwarding depending on the region or service provider.

## Mobile networks

Configure your mobile network settings.

On the Settings screen, tap **Mobile networks**.

- **Data roaming:** Set the device to use data connections when you are roaming.
- **Network mode** (single SIM models): Select a network type.  
**Network mode SIM 1 / Network mode SIM 2** (dual SIM models): Select a network type.
- **Access Point Names:** Set up access point names (APNs).
- **Network operators:** Search for available networks and manually register a network.

## NFC and payment

### Introduction

Your device allows you to read near field communication (NFC) tags that contain information about products. You can also use this feature to make payments and buy tickets for transportation or events after downloading the required apps.



The device contains a built-in NFC antenna. Handle the device carefully to avoid damaging the NFC antenna.

### Using the NFC feature

Use the NFC feature to send images or contacts to other devices, and read product information from NFC tags.

- 1 On the Settings screen, tap **NFC and payment**, and then tap the switch to activate it.
- 2 Place the NFC antenna area on the back of your device near an NFC tag.  
The information from the tag appears.

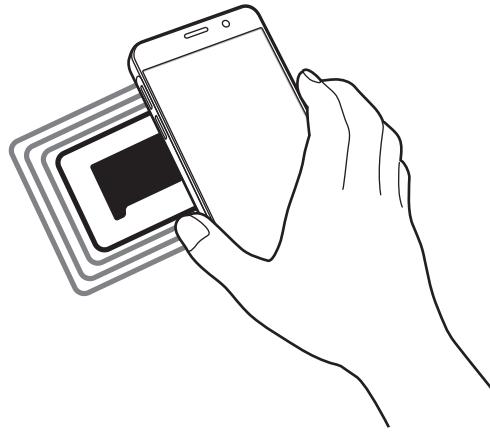

Ensure that the device's screen is unlocked. Otherwise, the device will not read NFC tags or receive data.

## Making payments with the NFC feature

Before you can use the NFC feature to make payments, you must register for the mobile payment service. To register or get more information about the service, contact your service provider.

- 1 On the Settings screen, tap **NFC and payment**, and then tap the switch to activate it.
- 2 Touch the NFC antenna area on the back of your device to the NFC card reader.

To set the default payment app, open the settings screen and tap **NFC and payment** → **Tap and pay**, and then select an app.



The payment services list may not include all available payment apps.

## Sending data

Allow data exchange when your device's NFC antenna touches the other device's NFC antenna.

- 1 On the Settings screen, tap **NFC and payment**, and then tap the switch to activate it.
- 2 Tap **Android Beam** and tap the switch to activate it.
- 3 Select an item and touch the other device's NFC antenna to your device's NFC antenna.
- 4 When **Touch to beam.** appears on the screen, tap your device's screen to send the item.



If both devices try to send data simultaneously, the file transfer may fail.

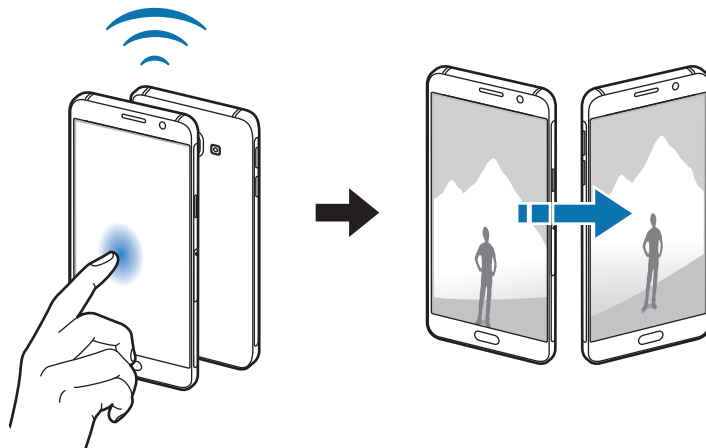

## More connection settings

### Options

Customise settings to control other features.

On the Settings screen, tap **More connection settings**.

- **Nearby device scanning:** Set the device to scan for nearby devices to connect to.
- **Printing:** Configure settings for printer plug-ins installed on the device. You can search for available printers or add one manually to print files. Refer to [Printing](#) for more information.
- **MirrorLink:** Use the MirrorLink feature to control your device's MirrorLink apps on the vehicle's head unit monitor. Refer to [MirrorLink](#) for more information.
- **Download booster:** Set the device to download files larger than 30 MB, faster via Wi-Fi and mobile networks simultaneously. Refer to [Download booster](#) for more information.
- **VPN:** Set up and connect to virtual private networks (VPNs).

### Printing

Configure settings for printer plug-ins installed on the device. You can connect the device to a printer via Wi-Fi or Wi-Fi Direct, and print images or documents.



Some printers may not be compatible with the device.

### Adding printer plug-ins

Add printer plug-ins for printers you want to connect the device to.

- 1 On the Settings screen, tap **More connection settings** → **Printing** → **Download plug-in**.
- 2 Search for a printer plug-in in **Play Store**.
- 3 Select a printer plug-in and install it.



4 Select the printer plug-in and tap the switch to activate it.

The device searches for printers that are connected to the same Wi-Fi network as your device.

To add printers manually, tap **MORE** → **Add printer** → **ADD PRINTER**.

To change print settings, tap **MORE** → **Printing settings**.

## Printing content

While viewing content, such as images or documents, tap **Share** → **Print** → ▼ → **All printers**, and then select a printer.

## MirrorLink

Connect your device to a vehicle to control your device's MirrorLink apps on the vehicle's head unit monitor.

On the Settings screen, tap **More connection settings** → **MirrorLink**.



Your device is compatible with vehicles that support MirrorLink version 1.1 or higher.

## Connecting your device to a vehicle via MirrorLink

When using this feature for the first time, connect the device to a Wi-Fi or mobile network.

1 Pair your device with a vehicle via Bluetooth.

Refer to [Pairing with other Bluetooth devices](#) for more information.

2 Connect your device to the vehicle using a USB cable.

When they are connected, access your device's MirrorLink apps on the head unit monitor.

## Ending the MirrorLink connection

Unplug the USB cable from your device and the vehicle.

## Download booster

Set the device to download files larger than 30 MB, faster via Wi-Fi and mobile networks simultaneously. A stronger Wi-Fi signal will provide a faster download speed.

On the Settings screen, tap **More connection settings** → **Download booster**.



- This feature may not be supported by some devices.
- You may incur additional charges when downloading files via the mobile network.
- When you download large files, the device may heat up. If the device exceeds a set temperature, the feature will turn off.
- If network signals are unstable, the speed and performance of this feature may be affected.
- If the Wi-Fi and mobile network connections have significantly different data transfer speeds, the device may use only the fastest connection.
- This feature supports Hypertext Transmission Protocol (HTTP) 1.1 and Hypertext Transmission Protocol Secure (HTTPS). The feature cannot be used with other protocols, such as FTP.

## Applications

Manage the device's apps and change their settings.

On the Settings screen, tap **Applications**.

- **Application manager:** View and manage the apps on your device.
- **Default applications:** Select a default setting for using apps.
- **Application settings:** Customise the settings for each app.

## Sounds and vibrations

Change settings for various sounds on the device.

On the Settings screen, tap **Sounds and vibrations**.

- **Sound mode:** Set the device to use sound mode or silent mode.
- **Vibrate while ringing:** Set the device to vibrate and play a ringtone for incoming calls.
- **Volume:** Adjust the volume level for call ringtones, music and videos, system sounds, and notifications.
- **Ringtone:** Change the ringtone settings.
- **Vibration pattern:** Select a vibration pattern.
- **Notification sounds:** Select a default notification sound. You can also change the notification settings for each app.
- **Touch sounds:** Set the device to sound when you select an app or option on the touchscreen.
- **Screen lock sounds:** Set the device to sound when you lock or unlock the touchscreen.
- **Charging sounds:** Set the device to sound when it is connected to a charger.
- **Dialling keypad tones:** Set the device to sound when you tap the buttons on the keypad.
- **Keyboard sound:** Set the device to sound when a key is touched.
- **Sound quality and effects:** Configure additional sound settings.

## Display

Change the display settings.

On the Settings screen, tap **Display**.

- **Brightness:** Adjust the brightness of the display.
- **Font:** Change the font size and type.
- **Icon backgrounds:** Set whether to display shaded backgrounds to make icons stand out.
- **Screen timeout:** Set the length of time the device waits before turning off the display's backlight.

- **Smart stay:** Set the device to prevent the display backlight from turning off while you are looking at the display.
- **Screen mode:** Change the screen mode to adjust the display's colour and contrast.
- **Screensaver:** Set the device to launch a screensaver when the device is charging.

## Advanced features

Activate advanced features and change the settings that control them.

On the Settings screen, tap **Advanced features**.



Excessive shaking or impact on the device may result in unintended inputs. Control motions properly.

- **Quick launch Camera:** Set the device to launch the camera by pressing the Home key twice quickly.
- **Smart capture:** Set the device to capture content that continues across multiple screens, and crop and share the screenshot immediately.
- **Smart alert:** Set the device to alert you if you have missed calls or new messages when you pick up the device.



This feature may not work if the screen is turned on or the device is not on a flat surface.

- **Easy mute:** Set the device to mute incoming calls or alarms by using palm motions or facing the device's screen downwards.

## Wallpaper

Change the wallpaper settings for the Home screen and the locked screen.

On the Settings screen, tap **Wallpaper**.

## Themes

Apply various themes to the device to change the visual elements of the Home screen, locked screen, and icons.

On the Settings screen, tap **Themes**.

To download more themes, tap **MORE THEMES**.

## Lock screen and security

Change the settings for securing the device and the SIM or USIM card.

On the Settings screen, tap **Lock screen and security**.



The available options may vary depending on the screen lock method selected.

- **Screen lock type:** Change the screen lock method.
- **Info and app shortcuts:** Change settings for the items displayed on the locked screen.
- **Notifications on lock screen:** Set whether or not to show notification content on the locked screen and select which notifications to display.
- **Find My Mobile:** Activate or deactivate the Find My Mobile feature. Access the Find my mobile website ([findmymobile.samsung.com](https://findmymobile.samsung.com)) to track and control your lost or stolen device.
- **Unknown sources:** Set the device to allow the installation of apps from unknown sources.
- **Encrypt device:** Encrypt your device's data to prevent others from accessing it if the device is lost or stolen. To use your encrypted device, you must decrypt the device's data every time you turn on the device. You can set whether your device's data will be decrypted automatically or whether an unlock code is required. It is not possible to back up or restore data when it is encrypted. If you enter the unlock code incorrectly several times in a row and reach the attempt limit, your device will perform a factory data reset.

- **Encrypt SD card:** Set the device to encrypt files on a memory card.



If you reset your device to the factory defaults with this setting enabled, the device will not be able to read your encrypted files. Disable this setting before resetting the device.

- **Other security settings:** Configure additional security settings.

## Privacy and safety

### Options

Change the settings for maintaining your privacy and safety.

On the Settings screen, tap **Privacy and safety**.

- **Location:** Change settings for location information permissions.
- **App permissions:** View the list of features and apps that have permission to use them. You can also edit the permission settings.
- **Report diagnostic info:** Set the device to automatically send the device's diagnostic and usage information to Samsung.
- **Send SOS messages:** Set the device to send help messages by pressing the Power key three times. You can also send sound recordings along with the message to the recipients. Refer to [Send SOS messages](#) for more information.

### Send SOS messages

In an emergency situation, quickly press the Power key three times. The device sends messages to your primary contacts. The messages include your location information.

- 1 On the Settings screen, tap **Privacy and safety** → **Send SOS messages**, and then tap the switch to activate it.
- 2 Follow the on-screen instructions to add primary contacts if you have not already done so.

To send help messages with audio recordings or photos, tap the **Attach audio recording** or **Attach pictures** switch to activate it.



The **Attach pictures** option may not be available depending on the region or service provider.

### Adding primary contacts

On the Settings screen, tap **Privacy and safety** → **Send SOS messages** → **Send messages to** → **ADD**. Tap **Create contact** and enter contact information or tap **Select from contacts** to add an existing contact as a primary contact.

## Easy mode

Easy mode provides an easier user experience by using a simpler layout and bigger icons on the Home screen.



Some app features may not be available in easy mode.

### Switching to easy mode

- 1 On the Settings screen, tap **Easy mode** → **Easy mode**.
- 2 Select apps under **Easy applications** to apply a simpler layout.
- 3 Tap **DONE**.

### Returning to standard mode

Swipe to the left on the Home screen and tap **Settings** → **Easy mode** → **Standard mode** → **DONE**.

## Managing shortcuts

To add a shortcut to an app to the Home screen, swipe to the left, tap , and then select an app.

To add a shortcut to a contact on the Home screen, swipe to the right and tap .

To delete a shortcut from the Home screen, tap **EDIT** and select an app or contact with .

## Accessibility

Configure various settings to improve accessibility to the device.

On the Settings screen, tap **Accessibility**.

- **Vision:** Customise the settings to improve accessibility for visually impaired users.
- **Hearing:** Customise the settings to improve accessibility for users with hearing impairment.
- **Dexterity and interaction:** Customise the settings to improve accessibility for users who have reduced dexterity.
- **Direction lock:** Change the directional combination settings for unlocking the screen.
- **Direct access:** Set the device to open selected accessibility menus when you press the Home key three times quickly.
- **Notification reminder:** Set the device to alert you to notifications that you have not checked at the interval.
- **Answering and ending calls:** Change the method of answering or ending calls.
- **Single tap mode:** Set the device to control incoming calls or notifications by tapping the button instead of dragging it.
- **Manage accessibility:** Export or import the accessibility settings to share them with other devices.
- **Services:** View accessibility services installed on the device.



## Accounts

Add your Samsung and Google accounts, or other accounts, to sync with.

### Adding accounts

Some apps used on your device require a registered account. Create accounts to have the best experience with your device.

- 1 On the Settings screen, tap **Accounts** → **Add account**.
- 2 Select an account service.
- 3 Follow the on-screen instructions to complete the account setup.

To sync content with your accounts, select an account and select items to sync.

### Registering Samsung accounts

You need a Samsung account when using some Samsung apps. You can back up or restore data saved in the device to your Samsung account. Register your Samsung account to the device to conveniently use Samsung services.

- 1 On the Settings screen, tap **Accounts** → **Add account**.
- 2 Tap **Samsung account**.
- 3 Follow the on-screen instructions to complete the account setup.

Once your Samsung account has been registered, you can use apps requiring your Samsung account without the sign in procedure.

### Removing accounts

On the Settings screen, tap **Accounts**, select an account name, select the account to remove, and then tap **MORE** → **Remove account**.

## Backup and reset

Change the settings for managing settings and data.

On the Settings screen, tap **Backup and reset**.

- **Back up my data:** Back up your personal information and app data to the Samsung server. You can also set the device to automatically back up data.
- **Restore:** Restore previously backed up personal information and app data from your Samsung account.
- **Back up my data:** Set the device to back up settings and app data to the Google server.
- **Backup account:** Set up or edit your Google backup account.
- **Automatic restore:** Set the device to automatically restore settings and app data from the Google server when apps are reinstalled.
- **Auto restart:** Set the device to automatically optimise and restart itself at preset times for optimal performance.
- **Reset settings:** Return the device's settings to the factory default settings without deleting data.
- **Reset network settings:** Return the network connection settings to the factory default settings.
- **Factory data reset:** Reset settings to the factory default values and delete all data.

## Language and input

Select device languages and change settings, such as keyboards and voice input types. Some options may not be available depending on the selected language.

On the Settings screen, tap **Language and input**.

- **Language:** Select a display language for all menus and apps.
- **Default keyboard:** Select a default keyboard type for text input.
- **Samsung keyboard:** Change the Samsung keyboard settings.
- **Google voice typing:** Change the voice input settings.
- **Text-to-speech:** Change the text-to-speech settings.
- **Pointer speed:** Adjust the pointer speed for the mouse or trackpad connected to your device.

## Battery

View battery power information and change power saving options.

On the Settings screen, tap **Battery**.



The usage time left shows the time remaining before the battery power runs out. Usage time left may vary depending on your device settings and operating conditions.

- **BATTERY USAGE:** View the amount of battery power consumed by your device.
- **Power saving mode:** Activate power-saving mode and change the settings for power-saving mode. Refer to [Power saving mode](#) for more information.
- **Ultra power saving mode:** Extend standby time and reduce battery consumption by displaying a simpler layout and allowing limited access to an app. Refer to [Ultra power saving mode](#) for more information.
- **App power saving:** Save battery power by managing your apps. You can also view a list of apps that are consuming an excessive amount of battery power.
- **Percentage on status bar:** Set the device to display the remaining battery life.

## Storage

View memory information for your device.

On the Settings screen, tap **Storage**.



The actual available capacity of the internal memory is less than the specified capacity because the operating system and default apps occupy part of the memory. The available capacity may change when you update the device.

## Date and time

Access and alter the following settings to control how the device displays the time and date.

On the Settings screen, tap **Date and time**.



If the battery remains fully discharged or removed from the device, the time and date is reset.

- **Automatic date and time:** Automatically update the time and date when moving across time zones. When this feature is deactivated, you can manually set the date, time, and time zone.
- **Use 24-hour format:** Display time in 24-hour format.

## User manual

View help information to learn how to use the device and apps or configure important settings.

On the Settings screen, tap **User manual**.

## About device

Access device information, edit the device name, or update device software.

On the Settings screen, tap **About device**.

# Appendix

## Troubleshooting

Before contacting a Samsung Service Centre, please attempt the following solutions. Some situations may not apply to your device.

### When you turn on your device or while you are using the device, it prompts you to enter one of the following codes:

- **Password:** When the device lock feature is enabled, you must enter the password you set for the device.
- **PIN:** When using the device for the first time or when the PIN requirement is enabled, you must enter the PIN supplied with the SIM or USIM card. You can disable this feature by using the Lock SIM card menu.
- **PUK:** Your SIM or USIM card is blocked, usually as a result of entering your PIN incorrectly several times. You must enter the PUK supplied by your service provider.
- **PIN2:** When you access a menu requiring the PIN2, you must enter the PIN2 supplied with the SIM or USIM card. For more information, contact your service provider.

### Your device displays network or service error messages

- When you are in areas with weak signals or poor reception, you may lose reception. Move to another area and try again. While moving, error messages may appear repeatedly.
- You cannot access some options without a subscription. For more information, contact your service provider.

### Your device does not turn on

When the battery is completely discharged, your device will not turn on. Fully charge the battery before turning on the device.

## The touchscreen responds slowly or improperly

- If you attach a screen protector or optional accessories to the touchscreen, the touchscreen may not function properly.
- If you are wearing gloves, if your hands are not clean while touching the touchscreen, or if you tap the screen with sharp objects or your fingertips, the touchscreen may malfunction.
- The touchscreen may malfunction in humid conditions or when exposed to water.
- Restart your device to clear any temporary software bugs.
- Ensure that your device software is updated to the latest version.
- If the touchscreen is scratched or damaged, visit a Samsung Service Centre.

## Your device freezes or encounters a fatal error

Try the following solutions. If the problem is still not resolved, contact a Samsung Service Centre.

### Restarting the device

If your device freezes or hangs, you may need to close apps or turn off the device and turn it on again.

### Forcing restart

If your device is frozen and unresponsive, press and hold the Power key and the Volume Down key simultaneously for more than 7 seconds to restart it.

### Resetting the device

If the methods above do not solve your problem, perform a factory data reset.

On the Apps screen, tap **Settings** → **Backup and reset** → **Factory data reset** → **RESET DEVICE** → **ERASE EVERYTHING**. Before performing the factory data reset, remember to make backup copies of all important data stored in the device.

## **Calls are not connected**

- Ensure that you have accessed the right cellular network.
- Ensure that you have not set call barring for the phone number you are dialling.
- Ensure that you have not set call barring for the incoming phone number.

## **Others cannot hear you speaking on a call**

- Ensure that you are not covering the built-in microphone.
- Ensure that the microphone is close to your mouth.
- If using a headset, ensure that it is properly connected.

## **Sound echoes during a call**

Adjust the volume by pressing the Volume key or move to another area.

## **A cellular network or the Internet is often disconnected or audio quality is poor**

- Ensure that you are not blocking the device's internal antenna.
- When you are in areas with weak signals or poor reception, you may lose reception. You may have connectivity problems due to issues with the service provider's base station. Move to another area and try again.
- When using the device while moving, wireless network services may be disabled due to issues with the service provider's network.

## **The battery icon is empty**

Your battery is low. Charge the battery.

## **The battery does not charge properly (For Samsung-approved chargers)**

- Ensure that the charger is connected properly.
- Visit a Samsung Service Centre and have the battery replaced.

## The battery depletes faster than when first purchased

- When you expose the device or the battery to very cold or very hot temperatures, the useful charge may be reduced.
- Battery consumption increases when you use messaging features or some apps, such as games or the Internet.
- The battery is consumable and the useful charge will get shorter over time.

## Your device is hot to the touch

When you use apps that require more power or use apps on your device for an extended period of time, your device may feel hot to the touch. This is normal and should not affect your device's lifespan or performance.

If the device overheats or feels hot for a prolonged period, do not use it for a while. If the device continues to overheat, contact a Samsung Service Centre.

## Error messages appear when launching the camera

Your device must have sufficient available memory and battery power to operate the camera app. If you receive error messages when launching the camera, try the following:

- Charge the battery.
- Free some memory by transferring files to a computer or deleting files from your device.
- Restart the device. If you are still having trouble with the camera app after trying these tips, contact a Samsung Service Centre.

## Photo quality is poorer than the preview

- The quality of your photos may vary, depending on the surroundings and the photography techniques you use.
- If you take photos in dark areas, at night, or indoors, image noise may occur or images may be out of focus.



## Error messages appear when opening multimedia files

If you receive error messages or multimedia files do not play when you open them on your device, try the following:

- Free some memory by transferring files to a computer or deleting files from your device.
- Ensure that the music file is not Digital Rights Management (DRM)-protected. If the file is DRM-protected, ensure that you have the appropriate licence or key to play the file.
- Ensure that the file formats are supported by the device. If a file format is not supported, such as DivX or AC3, install an app that supports it. To confirm the file formats that your device supports, visit [www.samsung.com](http://www.samsung.com).
- Your device supports photos and videos captured with the device. Photos and videos captured by other devices may not work properly.
- Your device supports multimedia files that are authorised by your network service provider or providers of additional services. Some content circulated on the Internet, such as ringtones, videos, or wallpapers, may not work properly.

## Another Bluetooth device is not located

- Ensure that the Bluetooth wireless feature is activated on your device.
- Ensure that the Bluetooth wireless feature is activated on the device you wish to connect to.
- Ensure that your device and the other Bluetooth device are within the maximum Bluetooth range (10 m).

If the tips above do not solve the problem, contact a Samsung Service Centre.

## A connection is not established when you connect the device to a computer

- Ensure that the USB cable you are using is compatible with your device.
- Ensure that you have the proper driver installed and updated on your computer.
- If you are a Windows XP user, ensure that you have Windows XP Service Pack 3 or higher installed on your computer.

## **Your device cannot find your current location**

GPS signals may be obstructed in some locations, such as indoors. Set the device to use Wi-Fi or a mobile network to find your current location in these situations.

## **Data stored in the device has been lost**

Always make backup copies of all important data stored in the device. Otherwise, you cannot restore data if it is corrupted or lost. Samsung is not responsible for the loss of data stored in the device.

## **A small gap appears around the outside of the device case**

- This gap is a necessary manufacturing feature and some minor rocking or vibration of parts may occur.
- Over time, friction between parts may cause this gap to expand slightly.

## Removing the battery

- To remove the battery, you **must** visit an authorised service centre with the provided instructions.
- For your safety, you **must not attempt to remove** the battery. If the battery is not properly removed, it may lead to damage to the battery and device, cause personal injury, and/or result in the device being unsafe.
- Samsung does not accept liability for any damage or loss (whether in contract or tort, including negligence) which may arise from failure to precisely follow these warnings and instructions, other than death or personal injury caused by Samsung's negligence.

- 1 Remove the SIM card tray from the device.
- 2 To soften the adhesive that holds the back cover to the main device, the device must be warmed to a controlled level using a dedicated temperature controlled chamber.  
Attach a suction pad removal tool to the lower end of the rear case and while holding the device firmly, pull the back cover away from the bottom upwards.
- 3 Loosen and remove the screws at the location points and remove the chassis.
- 4 Disconnect the battery connector and gently lever the battery away from the main body of the unit.

## Copyright

Copyright © 2016 Samsung Electronics

This manual is protected under international copyright laws.

No part of this manual may be reproduced, distributed, translated, or transmitted in any form or by any means, electronic or mechanical, including photocopying, recording, or storing in any information storage and retrieval system, without the prior written permission of Samsung Electronics.

## Trademarks

- SAMSUNG and the SAMSUNG logo are registered trademarks of Samsung Electronics.
- Bluetooth® is a registered trademark of Bluetooth SIG, Inc. worldwide.
- Wi-Fi®, Wi-Fi Protected Setup™, Wi-Fi Direct™, Wi-Fi CERTIFIED™, and the Wi-Fi logo are registered trademarks of the Wi-Fi Alliance.
- All other trademarks and copyrights are the property of their respective owners.