

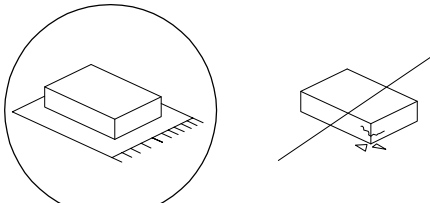





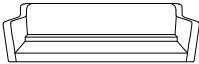

	30
		
		1

1/4

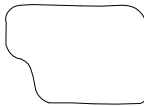
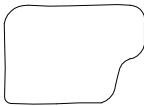
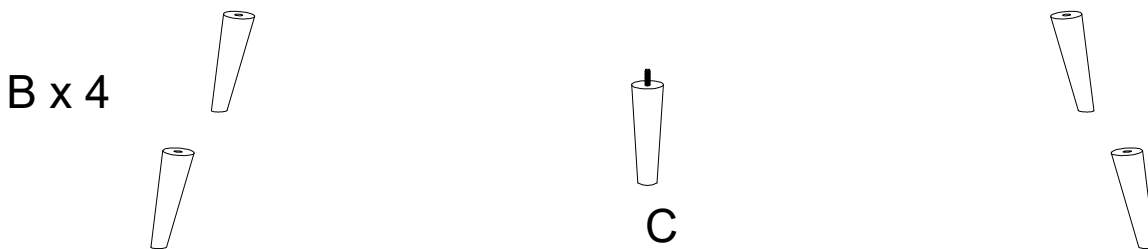
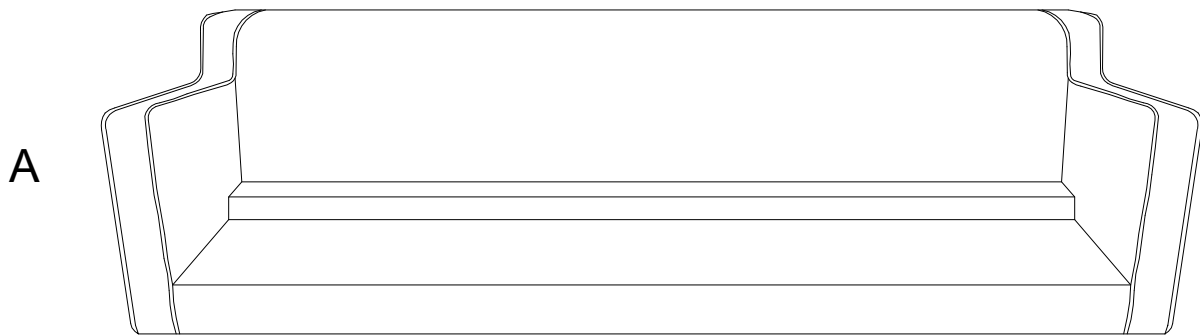
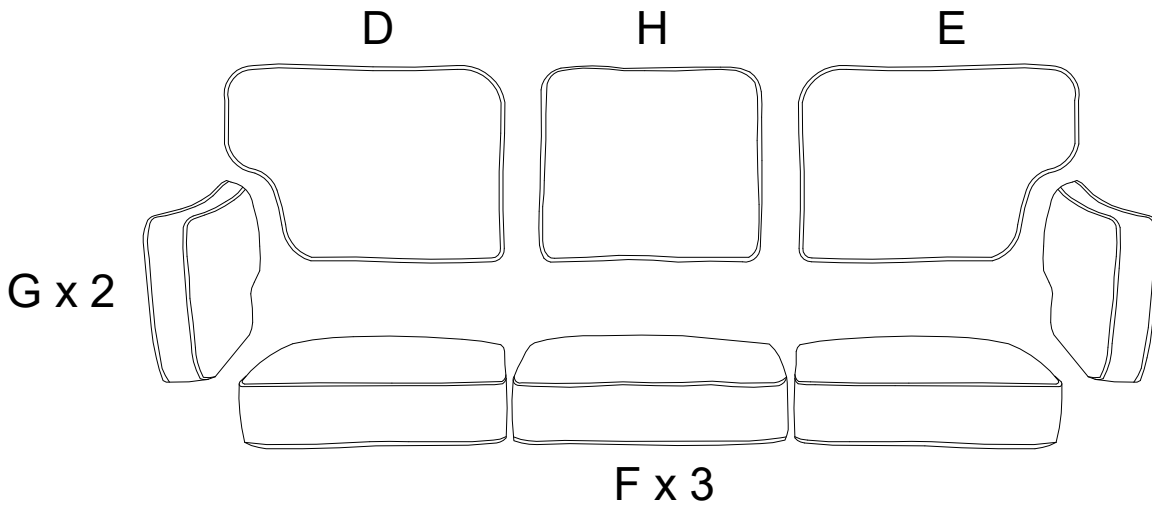
A	B	C	D	E
				
x 1	x 4	x 1	x 1	x 1

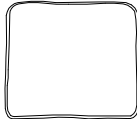



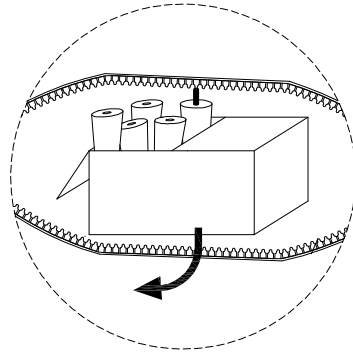
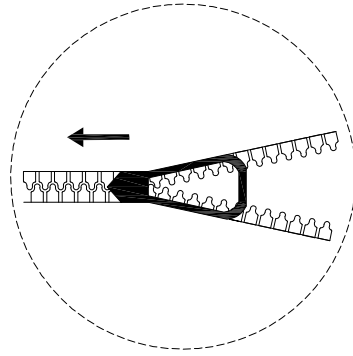
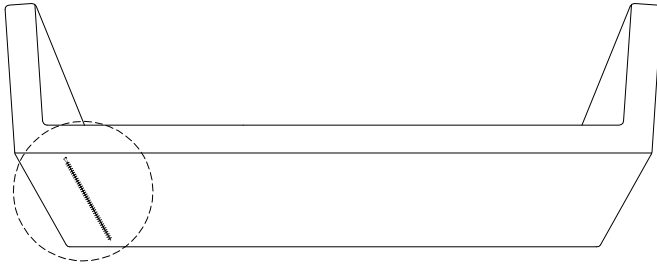

F	G	H	I	J	K
				 M8 x 65	
x 3	x 2	x 1	x 1	x 4	x 4

!

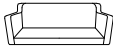

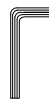

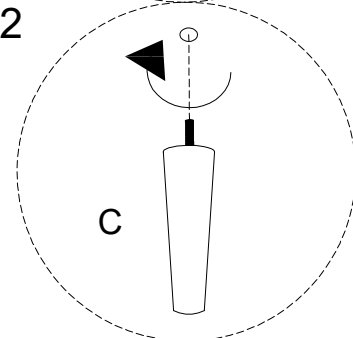
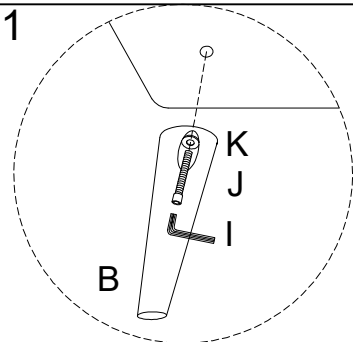
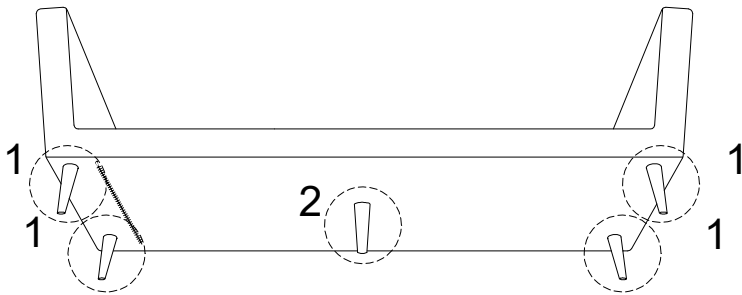

1

A  x 1	B  x 4	C  x 1	I  x 1	J  M8 x 65 x 4	K  x 4
--	--	--	---	---	--



2

D  x 1	E  x 1	F  x 3	G  x 2	H  x 1
---	---	---	---	---

