

FUJIFILM

instax mini Link

Smartphone Printer

User's Guide (Full version)



Table of Contents

Before Use.....	3
Notes on Disposing of the Printer	3
Part Names.....	3
Installing the App.....	4
Charging the Battery	4
Battery Status Indication with the LED.....	4
Charging Status Indication with the LED	4
Loading/Unloading the instax mini Film Pack.....	5
Loading the Film Pack.....	5
Unloading a Used Film Pack	5
Turning on/off the Printer.....	6
Checking the Printer Status with the LED.....	6
Connecting and Printing.....	6
When Connecting to the Printer for the First Time	6
When the Printer and Smartphone Are Already Connected	8
Reprinting an Image	9
Controlling the App with the Orientation of the Printer and the Power Button.....	10
Changing the App Mode When the Home Screen Is Selected on the App.....	10
Controlling Zoom and Shutter When Using the instax Camera on the App.....	10
Specifications	11
Troubleshooting	11
IMPORTANT SAFETY NOTICE	12
Simple Printer Care.....	13
Bluetooth® Devices: Cautions.....	13

Independent JPEG Group (IJG) Licenses

This software is based in part on the work of the Independent JPEG Group.

© 2019 FUJIFILM Corporation. All rights reserved.

Before Use

Before using the printer, check the following has been included.

Supplied Accessories

- USB cable for charging (1)
- User's Guide (1)

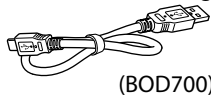

(BOD700)

Notes on Disposing of the Printer

A built-in lithium ion battery is used for this printer.

When you dispose of the printer, follow your local regulations. Please refer to the supplied CONTACT INFORMATION sheet for queries.

If your country or region is not included in the sheet, please contact your local distributor.

CAUTION

Do not attempt to remove the built-in battery, this may cause injury.



Disposal of Electric and Electronic Equipment in Private Households
Disposal of used Electrical & Electronic Equipment (Applicable in the European Union and other European countries with separate collection systems)

This symbol on the product, or in the manual and in the warranty, and/or on its packaging indicates that this product shall not be treated as household waste. Instead it should be taken to an applicable collection point for the recycling of electrical and electronic equipment.

By ensuring this product is disposed of correctly, you will help prevent potential negative consequences to the environment and human health, which could otherwise be caused by inappropriate waste handling of this product.

The recycling of materials will help to conserve natural resources. For more detailed information about recycling of this product, please contact your local city office, your household waste disposal service or the shop where you have purchased the product.

In Countries outside of EU: If you wish to discard this product, please contact your local authorities and ask for the correct way of disposal.



This Symbol on the batteries or accumulators indicates that those batteries shall not be treated as Household waste.

For customers in Turkey:

EEE Complies with Directive.

Read "IMPORTANT SAFETY NOTICE" (p. 12) for safety use.

Part Names

- ❶ When using the printer for the first time, ensure that the battery is fully charged.

Front

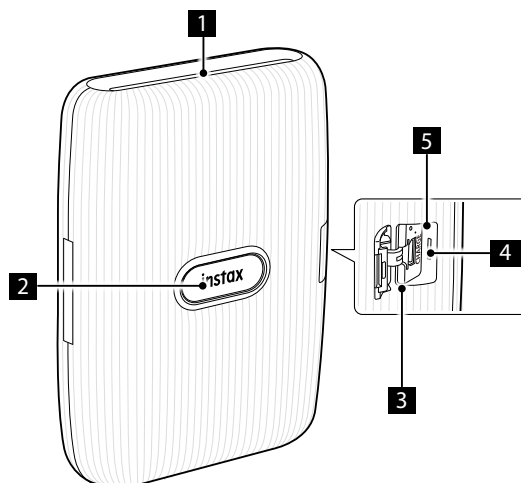

Rear

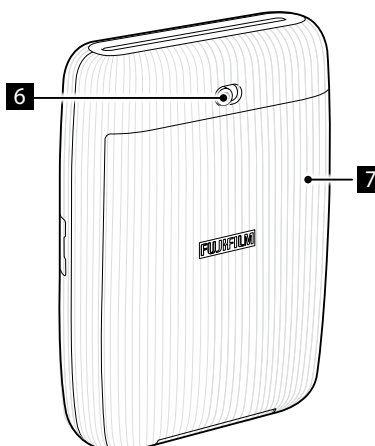

- ❶ Film ejection slot
- ❷ Power button/LED*¹
- ❸ USB port cover
- ❹ USB port
- ❺ Reset button*²
- ❻ Film door lock
- ❼ Film door

*1 For details on the LED indication, see pages 4 and 6.

*2 If the printer does not work properly, press the reset button to reset the printer.

Installing the App

Please install the mini Link Smartphone App before using the printer.

- If you are using an Android OS smartphone, please search for the mini Link Smartphone App in Google Play Store and install it.
 - *Requirements for Android OS smartphones: Android Ver. 5.0 or higher with Google Play Store installed
- If you are using an iOS smartphone, please search for the mini Link Smartphone App in the App Store and install it.
 - *Requirements for iOS smartphones: iOS Ver. 10.0 or higher
- Even if you have downloaded the app and your smartphone meets the above requirements, you may not be able to use the mini Link Smartphone App. This is dependent upon your smartphone model.

Access instax mini Link app download site for the latest information on system requirements.

Charging the Battery

- ❗ Ensure USB is correctly attached as indicated.

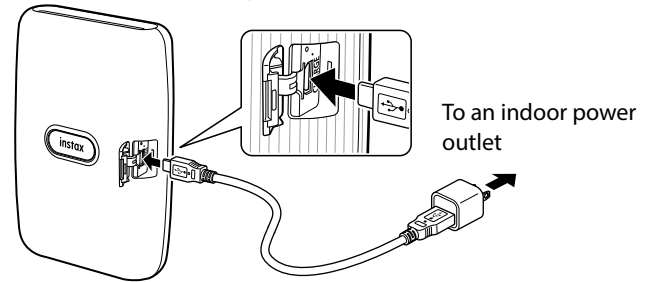

Connect the printer using the supplied USB cable to a USB AC adapter then connect the USB AC adapter to an indoor power outlet.

- You can print an image while charging is in progress.
- Charging time is approximately 80 to 120 minutes.

Battery Status Indication with the LED

Battery status can be determined whilst the printer is not connected to the app. Battery status can also be checked whilst the printer is connected to your smartphone via the app.

Indication	Battery status
LED lights up in red	Low battery remaining
LED lights up in green	Battery is over halfway charged

Charging Status Indication with the LED

Battery status can be checked with the LED.

Indication	Charging status
LED flashes in red	Charging
LED flashes in green	Charging almost complete
LED lights up in green (When the printer is turned on and not connected to the app)	Charged
LED goes off (When the printer is turned off)	Charged

Charging from a PC:

- Connect the printer and PC directly. Do not connect via a USB hub or keyboard.
- If the PC goes into sleep mode while charging, charging is discontinued. To continue charging, exit sleep mode and then reconnect the USB cable.
- The battery may not be able to charge depending on the specifications, settings or conditions of the PC .

Notes

- The battery cannot be removed.
- The battery is not fully charged when shipped. Be sure to charge the battery before use.
- For notes about the battery, see "Common Sense Printer Care". (p.12)

Loading/Unloading the instax mini Film Pack

Caution

Do not open the film door until you have used up the film; otherwise, the rest of the film will become exposed and turn white. The film can no longer be used.

- When you load the film pack, never press the two rectangular holes on the back of the film pack.
- Never use a film pack beyond its shelf life; otherwise, it may damage the printer.

Use FUJIFILM instax mini Instant Film only. The instax SQUARE film or instax WIDE film cannot be used.

Notes on the film pack

- Each FUJIFILM instax mini film pack contains one black film protective cover and 10 film sheets.
- Do not remove the film pack from its inner foil packaging until you are ready to load the film into the printer.
- The film cover is ejected automatically when the film door is closed.

For details, refer to the instructions and warnings on FUJIFILM instax mini Instant Film.

Loading the Film Pack

- 1 Slide and hold the film door lock, then open the film door.

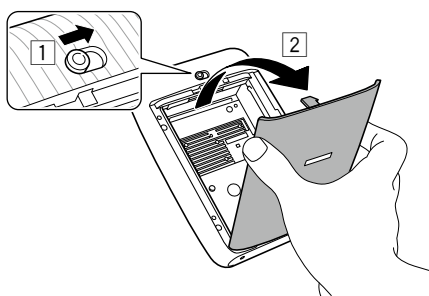

- 2 Insert film pack by aligning the yellow marks on the film pack and body of the printer.

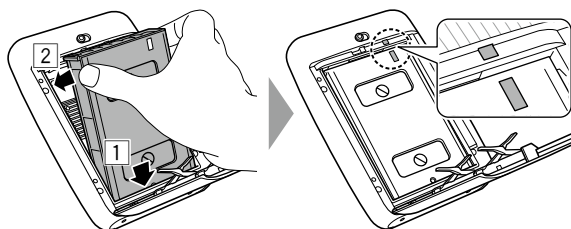

Note

Be sure to align the yellow marks on the printer and on the film pack.

- 3 Close the film door.

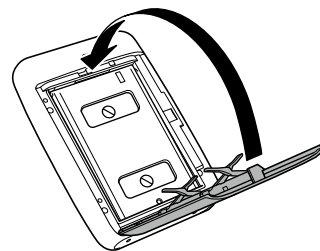

- 4 The black film protective cover will automatically be ejected. This can be removed and disposed of.

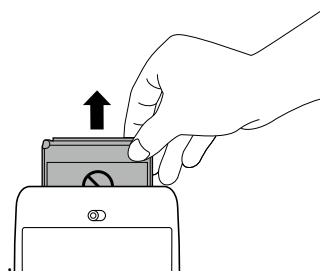

Unloading a Used Film Pack

- 1 Slide and hold the film door lock, then open the film door.

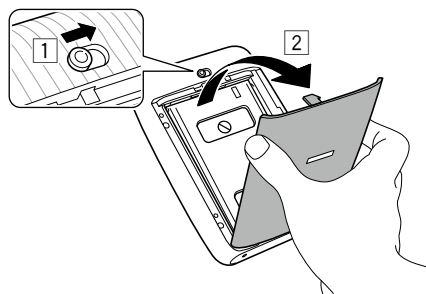

- 2 Grasp the rectangular holes on the film pack and remove the empty film cartridge.

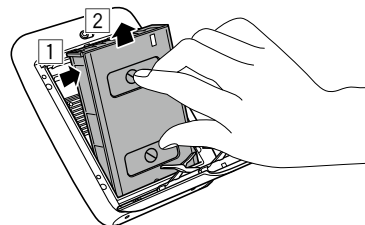

Turning on/off the Printer

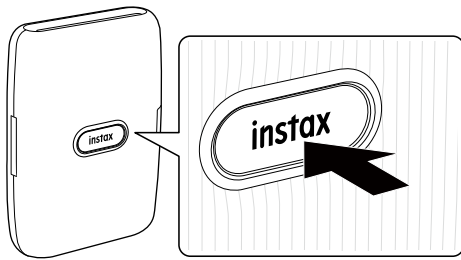

Press and hold the Power button for approximately 1 second to turn the printer on or off.

Turning the printer on lights up the LED.

If no operation occurs for roughly 10 minutes, the printer turns off automatically.

Checking the Printer Status with the LED

The following LED activity will indicate the following printer status.

Color	LED status	Status
Blue	Lit-solid	Connecting with the app/ Print mode
Orange	Lit-solid	Connecting with the app/ Fun mode
Pink	Lit-solid	Connecting with the app/instax Camera mode
White	Flashing wave- like form	Connecting with the app/ Operation screen
White	Flashing	Firmware is being updated
Purple	Lit-solid	Reprinting
Rainbow color	Flashing	Transferring an image
_*	Flashing*	Printing
Yellow	Lit-solid	Critical error occurred
Yellow	Flashing quickly	Non-critical error occurred
Yellow	Flashing slowly	Minor error occurred
Red	Flashing	Charging
Green	Flashing	Charging almost complete
Green	Lit-solid	Charged (When the printer is turned on and not connected with the app)

*During printing, the color of the flashing LED changes depending on the main colors of the image being transferred.

Connecting and Printing

When Connecting to the Printer for the First Time

- 1 Press and hold the Power button for approximately 1 second to turn the printer on. The LED lights up.

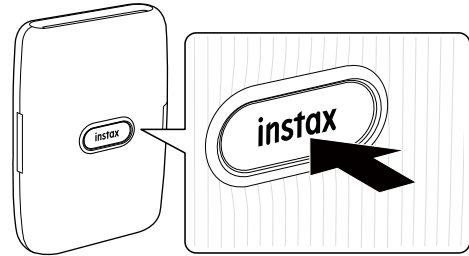

- 2 Open the "mini Link" app.

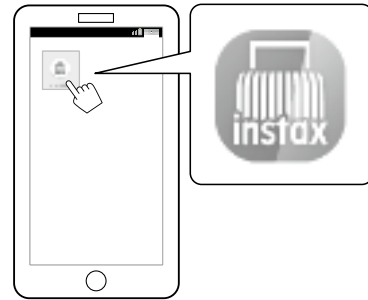

- 3 Read the terms of use, then put a checkmark in the [Agree to this content] box, and tap [Agree to this content →].



- 4 Quick instructions are displayed. Read the instructions and tap [I Understood →].**
 Set the [Bluetooth Connection] to [Later].
 [Bluetooth Connection] can also be set in the process of printing.



- 5 Select an image that you wish to print.**



- 6 Tap [Print] or swipe up on the screen.**
 Before tapping [Print], tapping [Crop] on the lower right adjusts the image and tapping [Filter] on the lower left filters the image.

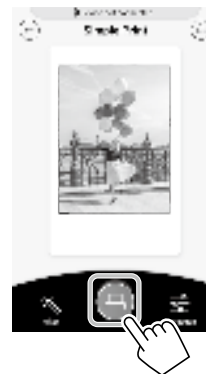

- Note**
 If your Bluetooth settings are switched off, the following screen appears.
 Tapping [Please turn on Bluetooth] opens the Bluetooth settings screen. Set the Bluetooth settings on.



- 7 When a printer is detected, tap [Connect].**
 If multiple printers are detected, select the printer to connect from the list.
 The printers identifier (device name) is located on the bottom of the printer.



- 8** When a printer is connected, tap [Close].



- 9** Tap  again.
The printer starts printing.

- 10** When the film has been ejected (the printer stops making a sound), hold the edge of the film and remove from the printer.

You can view the number of films remaining on the app.

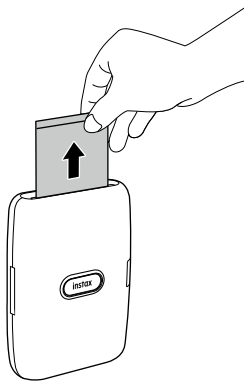

When the Printer and Smartphone Are Already Connected

- 1** Press and hold the Power button for approximately 1 second to turn the printer on.
The LED lights up.

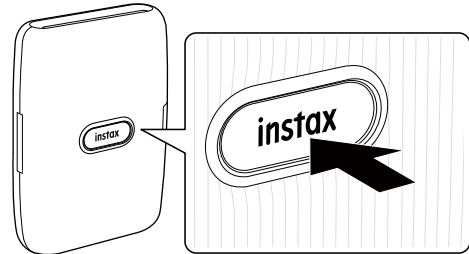

- 2** Open the “mini Link” app.

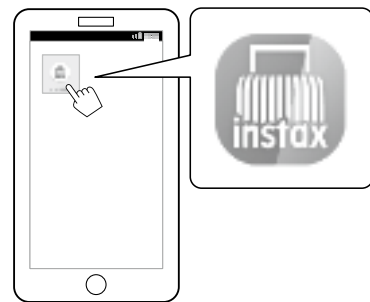



- 3** Select an image that you wish to print.



4 Tap or swipe up on the screen.

The printer starts printing.

Before tapping , tapping  on the lower right adjusts the image and tapping  on the lower left filters the image.

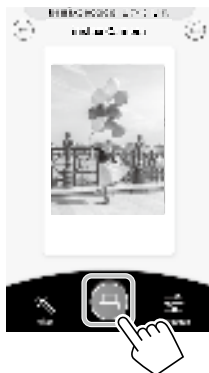

5 When the film has been ejected (the printer stops making a sound), hold the edge of the film and remove from the printer.

You can view the number of films remaining on the app.

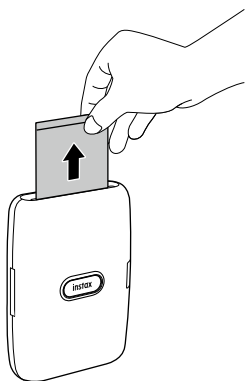

Reprinting an Image

The last image printed can be reprinted by turning the printer over with the film ejection slot facing downwards and pressing the power button.

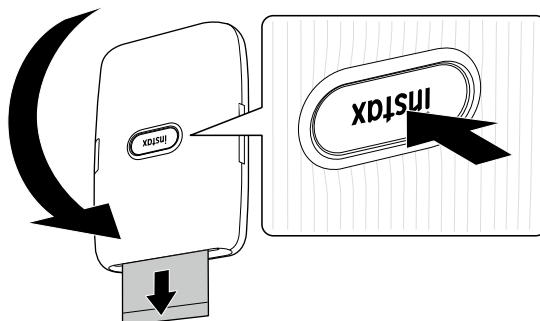

Notes

- When the printer is connected with the app and the app is in instax Camera mode, you cannot use the reprint function.
- The last stored image that has been printed is deleted when the printer is turned off. In this case, you are able to print the image from the app.
- When reprinting with the film ejection slot facing downwards, keep at least 10 cm distance between the printer and other objects.

Controlling the App with the Orientation of the Printer and the Power Button

When this printer is linked to the app on your smartphone or tablet, you can control the app by tilting the printer. (Smartphone app linked function)

For details, refer to the FAQ of the mini Link app.

Note

Make sure that [Camera operation settings] is set to [ON] on the mini Link app. When it is set to [OFF], this function is unavailable.

Changing the App Mode When the Home Screen Is Selected on the App

Stand the printer up to switch to Print mode.

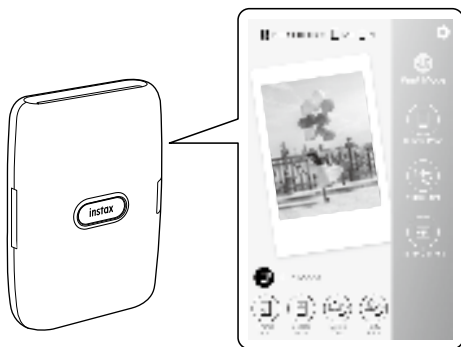

Lay the printer down with the Power button facing upwards to switch to Fun mode.

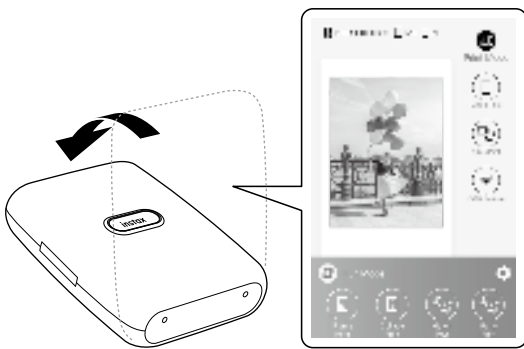

Notes

- You can change the app mode using the printer only when the home screen is selected.
- The Fun mode and Print mode buttons can be used regardless of the selected mode.

Controlling Zoom and Shutter When Using the instax Camera on the App

Tilt the printer forward to zoom in.

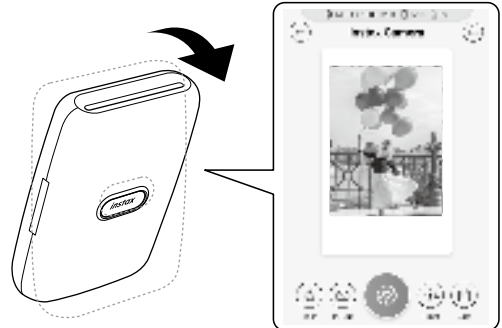

Tilt the printer backward to zoom out.

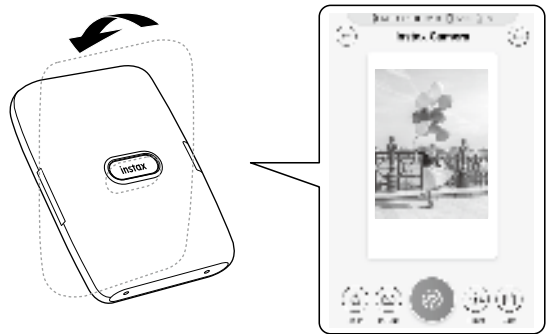

Press the Power button to release the shutter.

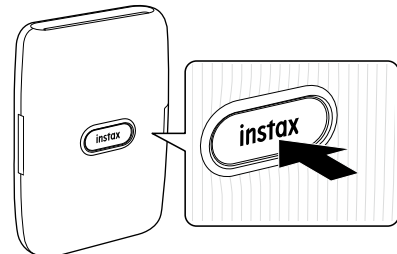

Specifications

Recording method	3-color exposure with OLED
Film used	FUJIFILM instax mini Instant Film (sold separately)
Number of films	10 films/pack
Image size	62 mm × 46 mm
Supported image size	800 × 600 dots
Printing resolution	12.5 dots/mm (318 dpi, 80 μm dot pitch)
Printing levels	256 levels per color (RGB)
Interface	Standard compliance: Bluetooth Ver. 4.2 (BLE)
Supported image format	JPEG, PNG, HEIF
Printing time	Image recording - photo output (fed out): Approximately 12 sec.
Approximate printing capacity	Approximately 100 prints (from full charge) * The number of prints depends on the usage conditions.
Power supply	Lithium ion battery (internal type: not removable)
Charging time	Approximately 80 to 120 minutes (Charging time depends on the temperature and battery remaining level)
Power consumption	Approximately 3 W
Operating environment	Temperature: +5 °C to +40 °C Humidity: 20% to 80% (no condensation)
Main unit dimensions	90.3 mm × 34.6 mm × 124.5 mm (excluding projecting parts)
Main unit mass	Approximately 209 g (excluding film pack)
Supplied accessory	USB cable (BOD700, Length: 30 cm)

*The above specifications are subject to change for performance improvement.

Troubleshooting

Please check the following items before considering a problem to be a malfunction. If the problem persists even after taking action, please contact the FUJIFILM service center for repair in your country or visit the website below.

FUJIFILM website: <http://www.fujifilm.com/>

If the following problem occurs...

Problem	Possible causes and solutions
I cannot turn on the printer.	<ul style="list-style-type: none"> The battery may not be charged. Please charge the printer. You did not press the Power button for long enough. Press and hold the Power button for approximately 1 second.
The battery loses its charge quickly.	If you use the printer in a very cold environment, the battery will drain quickly. Please keep the printer warm before printing.
The power cut off during use.	The battery level may be low. Please charge the printer.
Charging does not start.	Make sure that the USB power adapter plug is properly connected to the power outlet.
The printer takes too long to charge.	At low temperatures, charging may take longer.
Charging stops during charging.	Charge the battery in a temperature range of +5 °C to +40 °C. If you cannot charge the printer in this range, contact your FUJIFILM dealer or support center.
The printer does not function normally.	<ul style="list-style-type: none"> There may be a temporary malfunction. Please press the reset button. If the printer still does not function normally, please contact our repair service center for repair. The battery may not be charged. Please charge the printer.
The film pack does not load or does not load correctly.	<ul style="list-style-type: none"> Please use FUJIFILM instax mini Instant Film (other films cannot be used). Align the yellow mark on the film pack with the yellow alignment marker on the printer body, once aligned load the film into the printer.
The film does not unload.	<ul style="list-style-type: none"> The film may be misaligned due to shock such as vibration or dropping. Please load a new film pack. If the film is jammed, turn the printer off and turn it on again. If the problem persists, remove the jammed film and then load a new film pack.
Some or all of the finished prints are white.	Do not open the film door until the film has been used up. If the film door is opened with film remaining, the film will be exposed and become white.

Problem	Possible causes and solutions
The print is uneven.	<ul style="list-style-type: none"> • Do not shake, bend, fold or hold the print immediately after it is printed. • Do not obstruct the film ejection slot.
I cannot reprint images.	The last stored image that has been printed is deleted when the printer is turned off.
I cannot change the app mode even when operating the mini Link app.	Setting [Camera operation settings] on the mini Link app to [ON] enables the smartphone app linked function to work. Check the orientation of the printer.
The function that is used by tilting the printer does not work.	Confirm that [Camera operation settings] on the mini Link app is set to [ON].

IMPORTANT SAFETY NOTICE

This product has been designed with safety in mind and to also provide safe service when handled correctly in accordance with the User's Guide and the instructions provided. It is important that both the product and the "instax mini" film are handled properly and used only to print pictures as instructed in the User's Guide and in the "instax mini" film instructions. For your ease and safety, please follow what is written in the User's Guide. It is also a good idea to keep the User's Guide in a safe, easy to find place where you can refer to it if needed.

WARNING

This symbol indicates danger, which could result in injury or death. Please follow these instructions.

WARNING

 If any of the following instances occur, immediately unplug the USB cable, turn the printer off and cease use.

- The printer becomes hot, emits smoke, emits a burnt smell or is functioning abnormally.
- The printer is dropped into water or any foreign objects enter the printer.

 This device contains a built-in battery. Do not subject to heat, throw it into an open fire, drop or subject to impact. Doing so could cause the printer to explode.

WARNING

 Never attempt to take this product apart. You may be injured.

 If the printer is not functioning correctly, to avoid injury do not attempt to repair yourself. You may be injured.

 If this product is dropped or damaged so that the internals are visible, do not touch it. Contact your FUJIFILM dealer.

 Do not touch any parts within the inside of the back cover. This may cause injury.

 Never get this product wet or handle it with wet hands. Doing so may result in an electric shock.

 Promptly unplug the USB cable once battery is fully charged.

 Keep out of the reach of small children. This product could cause injury in the hands of a child.

 Do not cover or wrap the printer or the AC power adapter in a cloth or blanket. This can cause heat to build up and distort the casing or cause a fire.



The "CE" mark certifies that this product satisfies the requirements of the EU (European Union) regarding safety, public health, environment and consumer protection. ("CE" is the abbreviation of Conformité Européenne.)

Hereby, FUJIFILM declares that the radio equipment type "instax mini Link1" is in compliance with Directive 2014/53/EU. For more information, access the website below.

https://www.fujifilm.com/products/instant_photo/printers/instax_mini_link/

Simple Printer Care

■ **Printer Care**

1. **Do not open the film door until all film exposures have been used, doing so will prematurely expose the remaining film and render it unusable.**
2. Your printer is a fragile object. Do not expose it to water, sand or gritty materials.
3. Do not use solvent such as thinner or alcohol to remove dirt.
4. Keep the film chamber and printer interior clean to avoid damaging films.
5. Do not leave your printer in direct sunlight or hot places such as the inside of a car. Do not leave the printer in damp places for prolonged periods.
6. Moth repellent gas such as naphthalene may affect your printer and prints. Take care to keep your printer and prints in a safe, dry place.
7. Note that the temperature range within which your printer can operate is +5°C to +40°C.
8. Take great care to ensure that printed materials do not violate copyright, image rights, privacy or other personal rights and do not offend public decency. Actions that violate the rights of others, are contrary to public decency or constitute a nuisance may be punishable by law or otherwise legally actionable.
9. This printer is designed for household use. It is not suitable for commercial use.

■ **Charging the Battery**

The battery has not been charged during manufacture. Please charge the battery fully before use.

Charge the battery using the supplied USB cable. Charging times will increase at ambient temperatures below +10°C or above +35°C. Do not attempt to charge the battery at temperatures above +40°C or at temperatures below +5°C as the battery will not charge.

■ **Battery Life**

At normal temperatures, the battery can be recharged about 300 times. A noticeable decrease in the length of time the battery will hold a charge indicates that it has reached the end of its service life.

■ **Cautions: Handling the Battery**

The battery and printer body may become warm to the touch after extended use. This is normal.

■ **Certification marks acquired by the printer are located inside the film chamber.**

■ **Cautions During Printing**



Do not shake the printer while printing.



Do not drop the printer while printing.



Do not cover the film ejection slot while printing.

■ **“instax mini” Film and Print Care**

See FUJIFILM Instant Film “instax mini” for film use instructions. Follow all instructions for safe and proper use.

1. Keep the film in a cool place. Do not leave the film in a place where the temperature is extremely high (e.g., in a closed car) for many hours.

2. Do not puncture, tear, or cut “instax mini” film. If film becomes damaged, do not use.
3. When you load a film pack, use the film as soon as possible.
4. If the film has been kept in a place where the temperature is extremely high or low, bring it to room temperature before starting to print pictures.
5. Be sure to use the film before the expiration or “Use Before” date.
6. Avoid airport checked luggage inspection and other strong X-ray illumination. The effect of fogging, etc. may appear on unused film. We recommend that you carry the printer and/or the film onto the aircraft as carry-on luggage. (Check with each airport for more information.)
7. Avoid strong light, and keep the developed prints in a cool and dry place.
8. Do not puncture or cut this film as it contains a small amount of caustic paste (high alkaline). Never let children or animals put the film into their mouth. Also pay attention so that the paste does not come into contact with skin or clothes.
9. Should the paste inside the film come into contact with skin or clothes, immediately wash off with plenty of water. If the paste comes into contact with the eyes or mouth, immediately wash the area with plenty of water and contact a doctor. Note that the alkaline inside the film remains active for about 10 minutes after the picture has been printed.

■ **Cautions on Handling the Film and Prints**

For details, refer to the instructions and warnings on FUJIFILM Instant Film “instax mini”.



Bluetooth® Devices: Cautions

IMPORTANT: Read the following notices before using the product’s built-in Bluetooth transmitter.

■ **Use only as part of a Bluetooth network.**

FUJIFILM Corporation and its affiliates do not accept liability for damages resulting from unauthorized use. Do not use in applications requiring a high degree of reliability, for example in medical devices or other systems that may directly or indirectly impact human life. When using the device in computer and other systems that demand a greater degree of reliability than

Bluetooth networks, be sure to take all necessary precautions to ensure safety and prevent malfunction.

■ **Use only in the country in which the device was purchased.**

This device conforms to regulations governing Bluetooth devices in the country in which it was purchased. Observe all location regulations when using the device. FUJIFILM Corporation and its affiliates do not accept liability for problems arising from use in other jurisdictions.

■ **Wireless data (images) may be intercepted by third parties.**

The security of data transmitted over wireless networks is not guaranteed.

Do not use the device in locations subject to magnetic fields, static electricity, or radio interference.

■ **Do not use the transmitter in the vicinity of microwave ovens or in other locations subject to magnetic fields, static electricity, or radio interference that may prevent reception of wireless signals. Mutual interference may occur when the transmitter is used in the vicinity of other wireless devices operating in the 2.4 GHz band.**

■ **The Bluetooth transmitter operates in the 2.4 GHz band. The standard output is approximately 3.16 mW.**

■ **This device operates on the same frequency as commercial, educational, and medical devices and wireless transmitters.**

It also operates on the same frequency as licensed transmitters and special unlicensed low-voltage transmitters used in radio-frequency identification tracking systems for assembly lines and in other similar applications.

■ **To prevent interference with the above devices, observe the following precautions.**

Confirm that the radio-frequency identification transmitter is not in operation before using this device. If you notice that this device causes interference in low-voltage radio-frequency identification tracing systems, contact a FUJIFILM representative.

■ **The following may be punishable by law:**

- Disassembly or modification of this device.
- Removal of device certification labels.

■ **Trademark Information**

The Bluetooth® word mark and logos are registered trademarks owned by the Bluetooth SIG, Inc., and any use of such marks by FUJIFILM is under license.

Information for traceability in Europe

Manufacturer: FUJIFILM Corporation

Address, City: 7-3, Akasaka 9-Chome, Minato-ku, Tokyo

Country: JAPAN

Authorized representative in Europe:

FUJIFILM EUROPE GMBH

Address, City: Dusseldorf Heesenstrasse 31, 40549

Country: Germany

If you have any inquiries about this product, please contact a FUJIFILM authorized dealer, or access the website below.

<http://www.fujifilm.com/>

FUJIFILM

FUJIFILM Corporation

7-3, AKASAKA 9-CHOME, MINATO-KU, TOKYO 107-0052, JAPAN